

**Home  
collection**

**Tavoli  
Sedie  
Poltroncine  
Sgabelli**

*Tables / Tables  
Chairs / Chaises  
Armchairs / Petits fauteuils  
Stools / Tabourets*



**Listino Prezzi  
Febbraio 2024**

*February 2024 price list  
Liste de prix février 2024*

**SEEDIT**  
— ITALIAN LIVING —



## **Sistemi di apertura** p. 6

*Opening mechanisms / Systèmes d'ouverture*

## **Tavoli** p. 13

*Tables / Tables*

## **Consolle** p. 65

*Consoles / Consoles*

## **Sedie** p. 70

*Chairs / Chaises*

## **Poltroncine** p. 79

*Armchairs / Petits fauteuils*

## **Sgabelli** p. 82

*Stools / Tabourets*

**SEEDIT**  
— ITALIAN LIVING —

# Tavoli

Tables / Tables



**Baltik** p. 15



**Bamboo** p. 19



**Building** p. 21



**Evolution** p. 24



**Giò** p. 25



**Ikarus** p. 26



**Movida** p. 28



**\* Olimpo** p. 29



**Origami** p. 30



**Oscar** p. 33



**Sail** p. 35



**Silver** p. 38



**Space** p. 41



**Strong** p. 52



**Tiffany** p. 53



**Vela** p. 57



**Wave** p. 60



**Zoe round** p. 63

**\* Tavolo Olimpo in eliminazione**  
*Olimpo table available until stocks last*  
*Table Olimpo en cours d'élimination*

# Consolle

Consoles / Consoles



**Fiesta Console** p. 66



**Giravolta Console** p. 67

# Poltroncine

Armchairs / Petits fauteuils



**Arisa** p. 79



**Chicco** p. 79



**Carol** p. 79



**Lilium** p. 80



**Paris** p. 80



**Sofia** p. 80

# Sedie

Chairs / Chaises



**Abba** p. 70



**Adele** p. 70



**Alice** p. 70



**Arisa** p. 70/71



**Asia** p. 71



**Astoria** p. 71



**Camilla** p. 71



**Carol** p. 72



**Chicco** p. 72



**Cloc** p. 72



**Diva** p. 72



**Elena** p. 73



**Eva** p. 73



**Gaia** p. 73



**Havana** p. 73



**Home** p. 74



**Lea** p. 74



**Lilium** p. 74



**Lula** p. 74



**Luna** p. 75



**Megan** p. 75



**Moon** p. 75



**Nora** p. 75



**Ofra** p. 76



**Paris** p. 76



**Roxy** p. 76



**Sara** p. 77



**Sofia** p. 77



**Tequila** p. 77



**Twist** p. 77



**Vittoria** p. 78



**Zenda** p. 78

# Sgabelli

Stools / Tabourets



**Arisa** p. 82



**Bridge** p. 82



**Campus** p. 82



**Carol** p. 83



**Clio** p. 83



**Diva** p. 83



**Elena** p. 83



**Fez** p. 84



**July** p. 84



**Paris** p. 84/85



**Paris Gas** p. 85



**Sara** p. 85

# Sistemi di apertura

## New Up System binario scorrevole e alzabile con allunghe

*New Up System sliding, liftable track with extension leaves / New Up System rail coulissant et relevable avec allonges*

Due allunghe sono poste sotto il piano del tavolo, alle estremità di un binario scorrevole. Per allungare il tavolo è necessario far scorrere il binario verso l'esterno e alzarlo leggermente: in questo modo le allunghe escono e si posizionano a filo del piano principale.

Un sistema molto pratico che permette di prolungare il tavolo senza rinunciare allo stile.

*Two extension leaves are positioned under the table top at the ends of a sliding track. To extend the table, slide the track outwards and lift it slightly; this releases the extensions which are positioned flush to the main table top. This highly practical mechanism allows you to extend the table, without compromising on style.*

Deux allonges sont placées sous le plateau de table, aux extrémités d'un rail coulissant. Pour allonger la table, il est nécessaire de faire glisser le rail vers l'extérieur et de le relever légèrement : de cette façon, les allonges sortent et se placent au ras du plateau principal. Un système très pratique qui permet de rallonger la table sans renoncer au style.

### TAVOLI DISPONIBILI CON NEW UP SYSTEM

*Tables available with New Up System*

Tables disponibles avec **New Up System**

<b>BALTIK</b>	p. 17
<b>BUILDING</b>	p. 23
<b>IKARUS</b>	p. 27
<b>ORIGAMI</b>	p. 32
<b>SAIL</b>	p. 37
<b>SILVER</b>	p. 40
<b>TIFFANY</b>	p. 55
<b>VELA</b>	p. 59
<b>WAVE</b>	p. 62

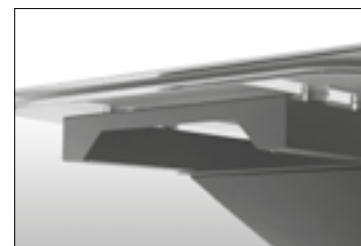

## Abbinamento finitura basamento/meccanismo corsie New Up System

*Pairings for the New Up System base/runner mechanism finishes / Association entre finition piètement et finition mécanisme des coulisses New Up System*

Codice <i>Code / Code</i>	Finiture basamento <i>Base finishes / Finitions piètement</i>	Finiture meccanismo allunghe <i>Extension leaf mechanism finishes / Finitions mécanisme allonges</i>
M121	Metallo Bianco Gesso / Chalk white metal / Métal blanc craie	Bianco / White / Blanc
M160	Metallo Antracite / Anthracite metal / Métal anthracite	Antracite / Anthracite / Anthracite
M161	Metallo Fango / Mud metal / Métal boue	Fango / Mud / Boue
M162	Metallo Platino / Platinum metal / Métal platine	Bianco / White / Blanc
M124	Metallo Madreperla / Mother of pearl metal / Métal nacre	Bianco / White / Blanc
M150	Metallo Canapa / Hemp metal / Métal chanvre	Bianco / White / Blanc
M127	Metallo Hot / Hot grey metal / Métal hot	Bianco / White / Blanc
M178	Metallo Arena / Arena metal / Métal arena	Fango / Mud / Boue
M130	Metallo Grigio Piacenza / Piacenza grey metal / Métal gris piacenza	Fango / Mud / Boue
M174	Metallo Fumo / Smoked metal / Métal fumée	Antracite / Anthracite / Anthracite
M175	Metallo Lava / Lava metal / Métal lava	Antracite / Anthracite / Anthracite
M128	Metallo Smoke / Smoke metal / Métal smoke	Fango / Mud / Boue
M164	Metallo Ardesia / Slate metal / Métal ardoise	Antracite / Anthracite / Anthracite
M131	Metallo Nero / Black metal / Métal noir	Antracite / Anthracite / Anthracite
M173	Metallo Ghiaccio / Ice metal / Métal givre	Bianco / White / Blanc
M177	Metallo Basalto / Basalt metal / Métal basalte	Antracite / Anthracite / Anthracite
M176	Metallo Bromo / Bromine metal / Métal brome	Antracite / Anthracite / Anthracite
M155	Metallo Carta da Zucchero / Baby blue metal / Métal bleu pastel	Antracite / Anthracite / Anthracite
M167	Metallo Onice / Onyx metal / Métal onyx	Antracite / Anthracite / Anthracite
M168	Metallo Bosco / Forest green metal / Métal vert forêt	Antracite / Anthracite / Anthracite
M159	Metallo Salvia / Sage metal / Métal sauge	Antracite / Anthracite / Anthracite
M165	Metallo Bronzo / Bronze metal / Metal bronze	Fango / Mud / Boue
M156	Metallo Bordeaux / Burgundy metal / Metal bordeaux	Antracite / Anthracite / Anthracite
M019	Metallo Oro / Gold metal / Métal Or	Antracite / Anthracite / Anthracite
M181	Metallo Titanio / Titanium metal / Métal Titane	Antracite / Anthracite / Anthracite

**Abbinamento colori meccanismo/basamento. Il meccanismo a richiesta può essere scelto in uno dei tre colori Best Seller (bianco, antracite, fango).**

*Mechanism/base colour pairings. On request, the mechanism can be chosen in one of the three Best Seller colours (white, anthracite, mud).*

Association entre coloris mécanisme et coloris piètement. Le mécanisme peut être choisi, sur demande, dans l'un des trois coloris best-seller (blanc, anthracite, boue).

---

## Book System apertura telescopica del piano

**Book System with telescopic table top / Book System ouverture télescopique du plateau**

Il movimento ricorda quello dell'apertura di un cassetto: il piano del tavolo si apre lateralmente tramite un meccanismo scorrevole e al suo interno è riposta, agganciata e ripiegata "a libro" l'allunga. A questo punto, è sufficiente aprire una o due allunghe per ottenere un tavolo con più posti a sedere per i propri ospiti.

*The movement resembles opening a drawer in that the table top pulls out sideways thanks to a sliding system. The extension leaf is folded away and fastened on the inside. Simply open out one or two leaves to create more seats at the table for your guests.*

Le mouvement rappelle celui de l'ouverture d'un tiroir : le plateau de la table s'ouvre latéralement par le biais d'un mécanisme coulissant alors que les allonges papillon sont accrochées et logées à l'intérieur. Il suffira donc d'ouvrir une ou deux allonges pour obtenir la longueur de table permettant de recevoir tous ses invités.

### TAVOLI DISPONIBILI CON **BOOK SYSTEM**

Tables available with **Book System**

Tables disponibles avec **Book System**

**BAMBOO** p. 20

**ZOE ROUND** p. 64



---

## Easy Book System apertura telescopica con allunga a libro

**Easy Book System telescopic opening mechanism with folded extension leaves / Easy Book System ouverture télescopique avec allonge papillon**

Il piano del tavolo si apre centralmente con gamba telescopica e al suo interno è riposta, agganciata e ripiegata "a libro" l'allunga. Con pochi semplici gesti riusciamo così ad allungare il nostro tavolo per poter aggiungere posti a sedere.

*The table top opens in the middle on a telescopic leg and houses the extensions leaves, which are attached and folded like a book. It takes just a few, simple steps to extend our table to seat more people.*

Le plateau de table s'ouvre au milieu grâce au pied télescopique alors que l'allonge papillon est accrochée et logée à l'intérieur. Quelques simples gestes suffisent pour allonger la table afin d'ajouter des places à table.

### TAVOLI DISPONIBILI CON **EASY BOOK SYSTEM**

Tables available with **Easy Book System**

Tables disponibles avec **Easy Book System**

**GIÒ** p. 25

**OLIMPO** p. 29



# Sistemi di apertura

## Evo System apertura con maniglia

**Evo System** opening mechanism with handle / **New Up System** ouverture avec poignée

Le due allunghe laterali e tutto il meccanismo che permettono la loro apertura, sono all'interno di un'elegante struttura che contiene tutto. Per allungare il tavolo basta tirare la maniglia dal lato del capotavola e, con due dita, alzare la prolunga: il meccanismo porterà automaticamente l'allunga in battuta con il piano e con il profilo. Un sistema innovativo di allunga che mette la funzionalità al primo posto senza rinunciare all'estetica.

*An elegant frame encloses two extension leaves, one at each end of the table, and the whole mechanism that pulls them out. To extend the table simply pull the handle at the head of the table and lift the extension leaf with two fingers: the mechanism will immediately lock the extension leaf into place so that it is flush with the table top and edge. This innovative table extension system focuses on functionality without detracting from aesthetics.*

Les deux rallonges latérales et tout le mécanisme qui permet de les sortir se trouvent à l'intérieur d'une élégante structure qui contient l'ensemble. Pour rallonger la table, il suffit de tirer la poignée située au bout de la table et, avec deux doigts, de soulever la rallonge: le mécanisme portera automatiquement la rallonge contre le plateau et le profil. Un système de rallonge innovant qui met la fonctionnalité au premier rang sans renoncer à l'esthétique.

### TAVOLI DISPONIBILI CON **EVO SYSTEM**

Tables available with **Evo System**  
Tables disponibles avec **Evo System**

**BALTIK** p. 18  
**TIFFANY** p. 56

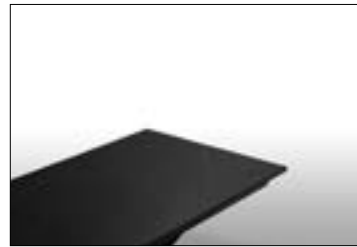
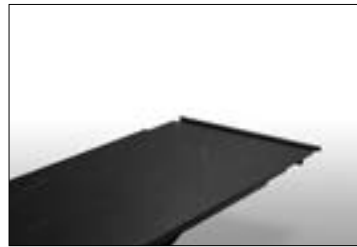
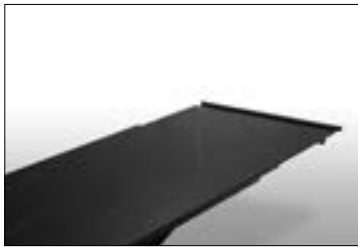

## One System staffe estraibili con allunghe esterne

**One System** pull-out brackets with external extension leaves / **One System** bras extractibles avec allonges séparées

Due staffe per lato sono poste sotto il piano del tavolo e, all'occorrenza, escono con un movimento scorrevole. Le allunghe vengono appoggiate e agganciate sopra le guide ma, nel momento in cui non sono necessarie, vengono tolte per essere custodite in uno spazio a piacere, mentre le staffe rientrano. In pochi e semplici step, il tavolo aumenta di dimensioni e di stile.

*Two brackets are positioned on each side under the table top and can be opened out via a sliding mechanism as required. The extension leaves are positioned on top of the runners and fastened in place. When they are no longer needed, they can be removed and stored in your chosen location, and the brackets fold away. Give the size and style of your table a boost in just a few simple steps.*

À chaque extrémité du plateau de table, deux bras extractibles sont logés au-dessous de celui-ci et, au besoin, ils coulissent vers l'extérieur. Les allonges sont posées et accrochées au-dessus des rails. Quand elles ne sont plus nécessaires, il suffira de les enlever et de les ranger à l'endroit choisi à tel effet, puis de rentrer les bras sous le plateau. Quelques simples gestes pour que la table change de dimensions et de style.

### TAVOLI DISPONIBILI CON **ONE SYSTEM**

Tables available with **One System**  
Tables disponibles avec **One System**

**BALTIK** p. 16  
**BUILDING** p. 22  
**ORIGAMI** p. 31  
**SAIL** p. 36  
**SILVER** p. 39  
**TIFFANY** p. 54  
**VELA** p. 58  
**WAVE** p. 61





---

## Cross System apertura telescopica della struttura

**Cross System** telescopic frame opening mechanism / **Cross System** ouverture télescopique de la structure

Con questa tipologia di apertura, l'intera struttura si apre lateralmente con un movimento scorrevole e all'interno del tavolo si trovano le allunghe per completare il piano. Una volta estratte e posizionate sopra le guide, le allunghe permettono di estendere il tavolo in più misure, a seconda di quanti piani aggiuntivi sono disponibili. Un sistema molto flessibile, che permette di scegliere di quanto allungare il tavolo.

*With this type of opening mechanism, the full table frame opens out sideways in a sliding motion. The extension leaves can be found inside, to complete the table top. Once extracted and positioned on top of the guides, the extension leaves can be used to extend the table to different sizes, depending on how many extension leaves are available. This flexible system allows you to choose how far you want to extend your table.*

Avec ce type d'ouverture, toute la structure s'ouvre latéralement avec un mouvement coulissant alors que les allonges se trouvent à l'intérieur de la table. Une fois sorties et placées sur les rails, les allonges permettront d'agrandir la table selon les besoins, en fonction du nombre d'allonges supplémentaires disponibles. Un système très flexible qui offre la possibilité de choisir la taille de sa table.

### TAVOLI DISPONIBILI CON **CROSS SYSTEM**

*Tables available with **Cross System***

Tables disponibles avec **Cross System**

<b>EVOLUTION</b>	p. 24
<b>MOVIDA</b>	p. 28
<b>OSCAR</b>	p. 34
<b>SPACE</b>	p. 47



# Tipologia piano



## Tipologia piano in materico e materico bordo scaricato per tavolo fisso e One System

*Types of textured tops and textured tops with reverse bevel for fixed and One system tables*

Types de plateau en texturé et texturé chant incliné pour table fixe et One System

Piano con profilo dritto e squadrato in materico spessore 1,4 - 2 - 3 cm. Materico bordo scaricato, piano rettangolare con profilo diritto e bordo scaricato in materico spessore 2 - 3 cm

*Textured top with straight and square edge, 1.4 - 2 - 3 cm thick.*

*Textured top with reverse bevel, textured rectangular top with straight edge and reverse bevel edge, 2 - 3 cm thick*

Plateau avec chant et angle droit en texturé, épaisseur 1,4 - 2 - 3 cm.

Texturé avec chant incliné, plateau rectangulaire avec pourtour droit et chant incliné, épaisseur 2 - 3 cm.

### TAVOLI DISPONIBILI

*Available tables*

Tables disponibles

<b>BALTIK</b>	p.	15-16
<b>BAMBOO</b>	p.	19
<b>BUILDING</b>	p.	21-22
<b>IKARUS</b>	p.	26
<b>ORIGAMI</b>	p.	30-31
<b>OSCAR</b>	p.	33
<b>SAIL</b>	p.	35-36
<b>SILVER</b>	p.	38-39
<b>SPACE</b>	p.	41-46
<b>STRONG</b>	p.	52
<b>TIFFANY</b>	p.	53-54
<b>VELA</b>	p.	57-58
<b>WAVE</b>	p.	61
<b>ZOE ROUND</b>	p.	63



## Tipologia piano ceramica per tavolo fisso e New Up System

*Types of ceramic tops for Up System tables*

Type plateau céramique pour table Up System

Piano con profilo dritto e squadrato in vetro accoppiato a una lastra ceramica.

*Top with straight and square profile, made from glass bonded to a ceramic slab.*

Plateau en verre avec chant droit uni à une plaque en céramique.

### TAVOLI DISPONIBILI

*Available tables*

Tables disponibles

<b>BALTIK</b>	p.	15
<b>BAMBOO</b>	p.	19
<b>BUILDING</b>	p.	21
<b>IKARUS</b>	p.	26
<b>ORIGAMI</b>	p.	30
<b>OSCAR</b>	p.	33
<b>SAIL</b>	p.	35
<b>SILVER</b>	p.	38
<b>TIFFANY</b>	p.	53
<b>VELA</b>	p.	57
<b>WAVE</b>	p.	60
<b>ZOE ROUND</b>	p.	63

# Space

La particolare struttura in alluminio può essere personalizzata per estendersi al centimetro sia in lunghezza, sia in larghezza. Un sistema flessibile nelle misure e versatile negli utilizzi, ideale per arredare uffici, spazi di condivisione e ambienti contract o per integrarsi a isole e penisole nelle cucine moderne.

*The unusual aluminium frame can be personalised to extend to the centimetre, both lengthways and widthways. This mechanism offers flexible size options and has versatile uses, ideal for furnishing offices, shared spaces and large turn-key project areas. This table also integrates well into islands and peninsulas in a modern kitchen.*

La structure en aluminium particulière peut être personnalisée pour s'allonger en centimètre soit en longueur, soit en largeur. Un système flexible dans les dimensions et polyvalent dans les utilisations, idéal pour meubler les bureaux, les espaces de partage et les environnements contract ou bien pour s'intégrer dans un îlot et un agencement en épi dans les cuisines modernes.

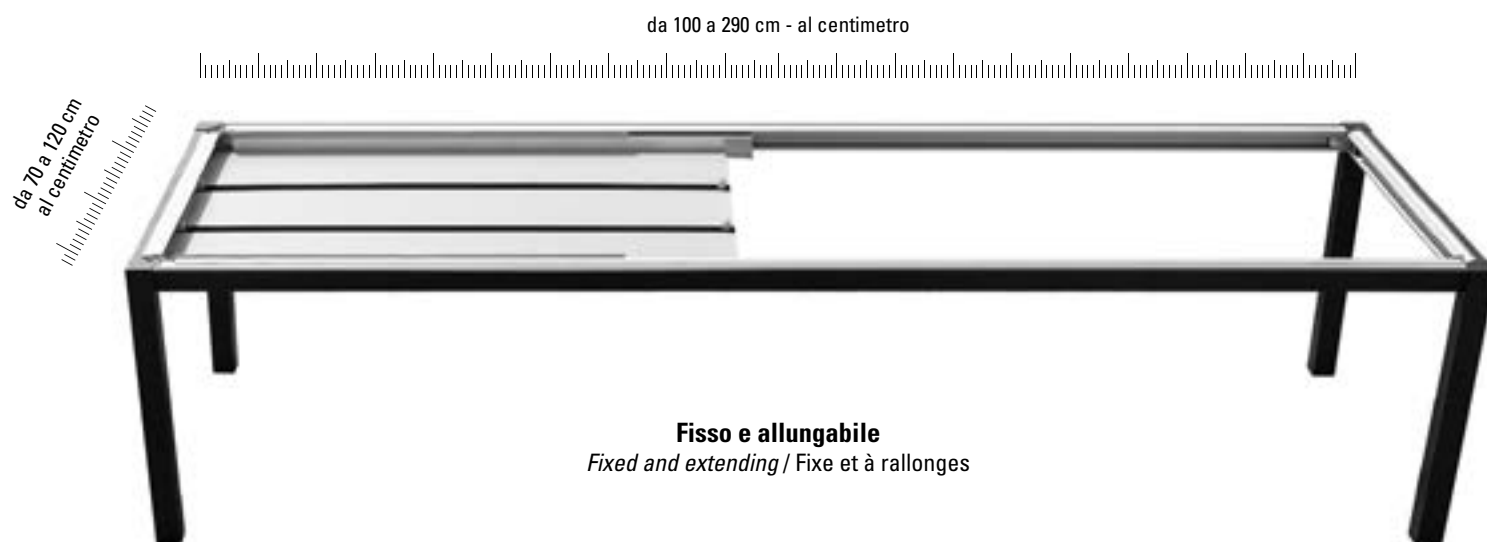

## Disponibile anche nella versione a penisola - Esempi di utilizzo

*Also available in the peninsula version - Examples of use*

Il existe également la version pour agencement en épi - Exemples d'utilisation



CUCINA  
KITCHEN / CUISINE



ZONA GIORNO  
LIVING ROOM / ESPACE SÉJOUR



SCRIVANIA  
DESK / BUREAU



# Tavoli



# Legenda

---



**N. colli**  
*N. packages*  
Nr. de colis

---



**Tavolo fisso rettangolare**  
*Fixed rectangular table*  
Table fixe rectangulaire

---

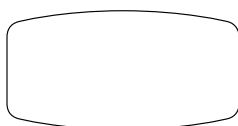

**Tavolo fisso botte**  
*Fixed barrel-shaped table*  
Table fixe forme tonneau

---



**Tavolo con n. 2 allunghe laterali destra e sinistra**  
*Table with 2 side extension leaves (left and right)*  
Table avec 2 allonges latérales droite et gauche

---



**Tavolo con n. 2 allunghe su 1 lato**  
*Table with 2 extension leaves on 1 side*  
Table avec 2 allonges sur un côté

---

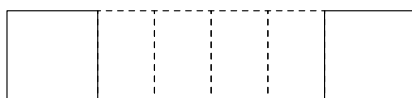

**Tavolo con allunghe centrali**  
*Table with central extension leaves*  
Table avec allonges centrales

---

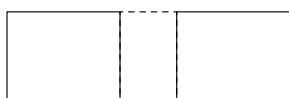

**Allunga centrale a libro**  
*Central folded extension leaves*  
Allonge centrale papillon

---



**2 allunghe laterali**  
*2 side extension leaves*  
2 allonges latérales

---

# Baltik - Fisso

## Baltik tavolo fisso

Baltik fixed table

Baltik table fixe

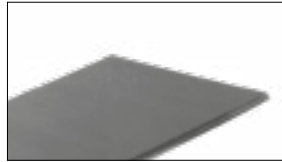

## Struttura in metallo verniciato

Coated metal frame / Structure en métal laqué

### Finiture struttura opaca di serie: Bianco Gesso - Antracite - Fango

Standard matt frame finishes:  
Chalk White - Anthracite - Mud

Finitions mates standard de la structure :  
Blanc Craie - Anthracite - Boue

### Maggiorazione per colore struttura optional (patella di copertina)

Surcharge for optional frame colour  
(see colour chart on cover)

Supplément pour coloris structure  
optionnel (voir rabat en couverture)

€ 350

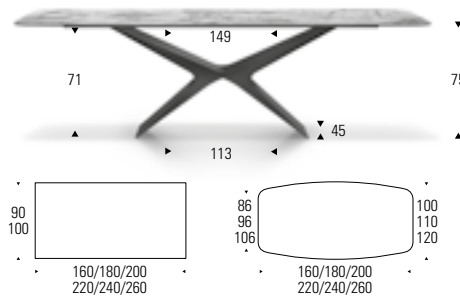

Profilo piano ceramica  
Ceramic top edge  
Chant plateau céramique



Profilo piano materico  
bordo scaricato  
Edge of textured top  
with bevelled edge  
Chant plateau texturé incliné



Profilo altri piani  
Edge for other tops  
Chant autres plateaux

	M <sup>3</sup>
160x90/110	0,75
180x100/110	0,80
200x100/110	0,85
220x100/120	0,90
240x100/120	1,10
260x100/120	1,23



		Materico Textured matt Texturé	Materico bordo scaricato Textured matt with sloping edge Texturé chant en pente	Vetro trasparente e fumé Clear and smoked glass Verre transparent et fumé	Glass decor	Ceramica Elegance Elegance Ceramic Céramique Elegance	Ceramica Premium Premium Ceramic Céramique Premium	Basamento Base Piètement
	cod.							
	Sp. Thk/Ép.	2 cm	3 cm	1,2 cm	1,2 cm	1,4 cm	1,4 cm	

## Rettangolare



<b>160x90</b> 63x36 inches	<b>BALF10</b>	-	<b>1.570</b>	<b>2.116</b>	<b>2.206</b>	<b>2.387</b>	<b>2.437</b>	<b>1.320</b>
	Kg		66	81	76	85	85	52
<b>180x100</b> 70x39 inches	<b>BALF12</b>	-	<b>1.582</b>	<b>2.226</b>	<b>2.310</b>	<b>2.464</b>	<b>2.654</b>	<b>1.320</b>
	Kg		73	92	86	97	97	52
<b>200x100</b> 78x39 inches	<b>BALF14</b>	-	<b>1.671</b>	<b>2.343</b>	<b>2.395</b>	<b>2.540</b>	<b>2.807</b>	<b>1.320</b>
	Kg		77	98	98	103	103	52
<b>220x100</b> 85x39 inches	<b>BALF16</b>	-	<b>1.751</b>	<b>2.482</b>	<b>2.555</b>	<b>2.638</b>	<b>2.897</b>	<b>1.320</b>
	Kg		80	104	102	110	110	52
<b>240x100</b> 94x39 inches	<b>BALF18</b>	-	<b>1.808</b>	<b>2.565</b>	<b>2.642</b>	<b>2.873</b>	<b>3.184</b>	<b>1.320</b>
	Kg		84	110	103	116	116	52
<b>260x100</b> 101x39 inches	<b>BALF20</b>	-	<b>1.869</b>	<b>2.636</b>	<b>2.788</b>	<b>3.012</b>	<b>3.341</b>	<b>1.320</b>
	Kg		87	116	105	123	123	52

## Botte



<b>160x100</b> 63x39 inches	<b>BALFB2</b>	<b>1.593</b>	-	<b>2.308</b>	<b>2.394</b>	<b>2.766</b>	<b>2.852</b>	<b>1.320</b>
	Kg	66		81	76	85	85	52
<b>180x110</b> 70x43 inches	<b>BALFB3</b>	<b>1.609</b>	-	<b>2.387</b>	<b>2.475</b>	<b>3.546 *</b>	<b>3.651</b>	<b>1.320</b>
	Kg	73		92	87	97	97	52
<b>200x110</b> 78x43 inches	<b>BALFB4</b>	<b>1.678</b>	-	<b>2.505</b>	<b>2.612</b>	<b>3.638 *</b>	<b>3.743</b>	<b>1.320</b>
	Kg	77		98	98	103	103	52
<b>220x120</b> 85x47 inches	<b>BALFB6</b>	<b>1.766</b>	-	<b>2.697</b>	<b>2.803</b>	<b>3.709 *</b>	<b>3.865</b>	<b>1.320</b>
	Kg	80		104	102	110	110	52
<b>240x120</b> 94x47 inches	<b>BALFB7</b>	<b>1.809</b>	-	<b>2.819</b>	<b>2.939</b>	<b>4.043 *</b>	<b>4.213</b>	<b>1.320</b>
	Kg	84		110	103	116	116	52
<b>260x120</b> 101x47 inches	<b>BALFB8</b>	<b>1.902</b>	-	<b>2.950</b>	<b>3.086</b>	<b>4.106 *</b>	<b>4.290</b>	<b>1.320</b>
	Kg	87		116	105	123	123	52

### \* Ceramica Elegance a botte solo su finitura Urban Marble 034 e Amani 035

Barrel-shaped Ceramica Elegance only available for Urban Marble 034 and Amani 035 finishes / Forme tonneau en Céramique Elegance uniquement dans les finitions Urban Marble 034 et Amani 035

# Baltik - Allungabile One system

## One system staffe estraibili con allunghe esterne

One system mechanism with pull-out brackets and external extension leaves

One system bras extractibles avec allonges séparées

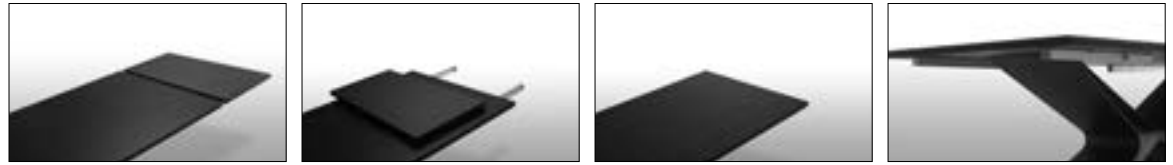

## Struttura in metallo verniciato

Coated metal frame / Structure en métal laqué

### Finiture struttura opaca di serie: Bianco Gesso - Antracite - Fango

Standard matt frame finishes: Chalk White - Anthracite - Mud

Finitions mates standard de la structure: Blanc Craie - Anthracite - Boue

### Maggiorazione per colore struttura optional (patella di copertina)

Surcharge for optional frame colour (see colour chart on cover)

Supplément pour coloris structure optionnel (voir rabat en couverture)

€ 350

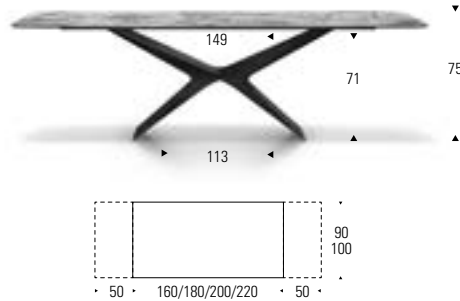

Profilo piano materico bordo scaricato

Edge of textured top with bevelled edge

Chant plateau texturé incliné

	M <sup>3</sup>
160x90	0,75
180x100	0,80
200x100	0,85
220x100	0,90



**Materico bordo scaricato**  
Textured matt with sloping edge  
Texturé chant en pente

cod.

Sp. Thk/Ép.

3 cm

## One system

	<b>160 (210-260)x90</b> 63 (82-102)x36 inches	<b>BAL010</b> Kg	<b>1.922</b> 83					
	<b>180 (230-280)x100</b> 70 (90-109)x39 inches	<b>BAL012</b> Kg	<b>2.009</b> 92					
	<b>200 (250-300)x100</b> 78 (95-118)x39 inches	<b>BAL014</b> Kg	<b>2.048</b> 96					
	<b>220 (270-320)x100</b> 85 (105-125)x39 inches	<b>BAL016</b> Kg	<b>2.084</b> 100					



# Baltik - Allungabile New up system

## New up system

### binario scorrevole e alzabile

New up system mechanism with sliding, lift-up track

New up system rail coulissant et relevable

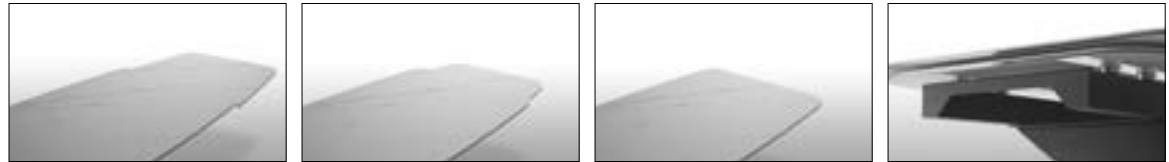

## Struttura in metallo verniciato

Coated metal frame / Structure en métal laqué

### Finiture struttura opaca di serie: Bianco Gesso - Antracite - Fango

Standard matt frame finishes: Chalk White - Anthracite - Mud

Finitions mates standard de la structure: Blanc Craie - Anthracite - Boue

### Maggiorazione per colore struttura optional (patella di copertina)

Surcharge for optional frame colour (see colour chart on cover)

€ 350

Supplément pour coloris structure optionnel (voir rabat en couverture)

### Maggiorazione su ceramica Premium con allunghe in Bilia

Surcharge for Premium ceramic top with extension leaves in a matching pattern

€ 400

Supplément pour céramique Premium avec allonges même aspect que plateau

### Allunghe ceramica Elegance non disponibile in Bilia

Elegance ceramic extension leaves not available in a matching pattern  
Allonges en céramique Elegance non disponibles avec même aspect que le plateau

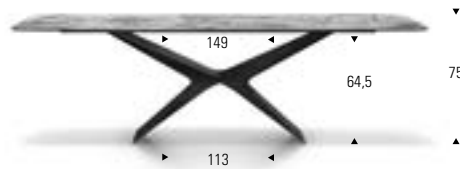

**Profilo piano ceramica**  
Ceramic top edge  
Chant plateau céramique

**Profilo piano materico bordo scaricato**  
Edge of textured top with bevelled edge  
Chant plateau texturé incliné

**Profilo altri piani**  
Edge for other tops  
Chant autres plateaux

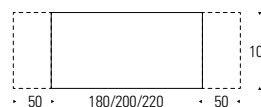
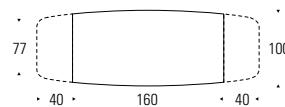
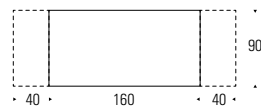

Indicare nell'ordine il colore del meccanismo se diverso dall'abbinamento consigliato (vedi pag. 6)  
Please specify the colour of the mechanism if it differs from the recommended pairings (see page 6)  
Indiquer dans la commande le coloris du mécanisme s'il est différent de l'association conseillée (voir page 6)

	M <sup>3</sup>
160x90/100	0,80
180x100/110	0,85
200x100/110	1,14
220x100/120	1,24



		Materico Textured matt Texturé	Materico bordo scaricato Textured matt with sloping edge Texturé chant en pente	Vetro trasparente e fumé Clear and smoked glass Verre transparent et fumé	Glass decor	Ceramica Elegance Elegance Ceramic Céramique Elegance	Ceramica Premium Premium Ceramic Céramique Premium
	cod.						
	Sp. Thk/Ép.	2 cm	2 cm	1,2 cm	1,2 cm	1,4 cm	1,4 cm

## New up system Rettangolare

	<b>160 (200-250)x90</b> 63 (78-95)x36 inches	<b>BALH10</b>	-	<b>2.660</b>	<b>3.619</b>	<b>4.003</b>	<b>4.222</b>	<b>4.413</b>
		Kg		77	104	104	98	98
	<b>180 (230-280)x100</b> 70 (90-109)x39 inches	<b>BALH12</b>	-	<b>2.772</b>	<b>3.762</b>	<b>4.062</b>	<b>4.429</b>	<b>4.762</b>
		Kg		86	125	125	116	116
	<b>200 (250-300)x100</b> 78 (95-118)x39 inches	<b>BALH14</b>	-	<b>2.833</b>	<b>3.844</b>	<b>4.169</b>	<b>4.554</b>	<b>4.911</b>
		Kg		90	131	131	123	123
	<b>220 (270-320)x100</b> 85 (105-125)x39 inches	<b>BALH16</b>	-	<b>2.923</b>	<b>4.012</b>	<b>4.281</b>	<b>4.715</b>	<b>5.096</b>
		Kg		94	137	137	128	128

## New up system Botte

	<b>160 (200-250)x100</b> 63 (78-95)x39 inches	<b>BALHB2</b>	<b>2.736</b>	-	<b>3.958</b>	<b>4.167</b>	<b>4.916</b>	<b>5.064</b>
		Kg	77		105	105	98	98
	<b>180 (230-280)x110</b> 70 (90-109)x43 inches	<b>BALHB3</b>	<b>2.814</b>	-	<b>4.158</b>	<b>4.295</b>	<b>5.696 *</b>	<b>5.907</b>
		Kg	86		120	120	116	116
	<b>200 (250-300)x110</b> 78 (95-118)x43 inches	<b>BALHB4</b>	<b>2.862</b>	-	<b>4.257</b>	<b>4.450</b>	<b>5.878 *</b>	<b>6.046</b>
		Kg	90		132	132	123	123
	<b>220 (270-320)x120</b> 85 (105-125)x47 inches	<b>BALHB6</b>	<b>2.977</b>	-	<b>4.389</b>	<b>4.787</b>	<b>5.983 *</b>	<b>6.142</b>
		Kg	94		132	132	128	128

### \* Ceramica Elegance a botte solo su finitura Urban Marble 034 e Amani 035

Barrel-shaped Ceramica Elegance only available for Urban Marble 034 and Amani 035 finishes / Forme tonneau en Céramique Elegance uniquement dans les finitions Urban Marble 034 et Amani 035

# Baltik - Allungabile Evo system

## Evo system apertura

Evo System mechanism

Evo system ouverture



## Struttura in metallo verniciato

Coated metal frame / Structure en métal laqué

### Finiture struttura opaca di serie: Bianco Gesso - Antracite - Fango

Standard matt frame finishes:  
Chalk White - Anthracite - Mud

Finitions mates standard de la structure :  
Blanc Craie - Anthracite - Boue

### Maggiorazione per colore struttura optional (patella di copertina)

Surcharge for optional frame colour  
(see colour chart on cover)

Supplément pour coloris structure  
optionnel (voir rabat en couverture)

€ 350

### Maggiorazione su ceramica Premium con allunghe in Bilia

Surcharge for Premium ceramic top with  
extension leaves in a matching pattern

Supplément pour céramique Premium  
avec allonges même aspect que plateau

€ 400

### Allunghe ceramica Elegance non disponibile in Bilia

Elegance ceramic extension leaves not available in a matching pattern

Allonges en céramique Elegance non disponibles avec même aspect  
que le plateau

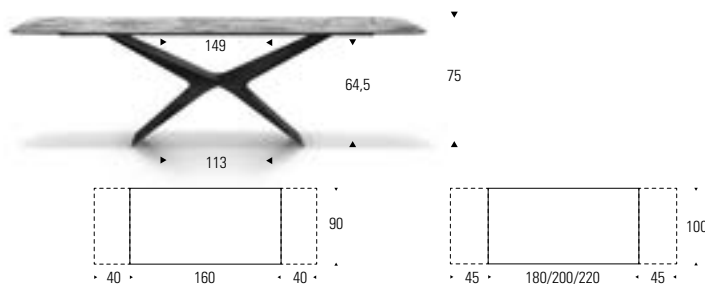

Profilo piano  
Profile top  
Chant plateau

	M <sup>3</sup>
160x90	1,04
180x100	1,14
200x100	1,24
220x100	1,34



cod.	Glass decor	Ceramica Elegance Elegance Ceramic Céramique Elegance	Ceramica Premium Premium Ceramic Céramique Premium				
Sp. Thk/Ép.	0,6 cm	0,6 cm	0,6 cm				

## Evo system

	<b>160 (200-240)x90</b> 63 (81-95)x36 inches	<b>BALV10</b>	<b>3.462</b>	<b>4.910</b>	<b>5.584</b>			
		Kg	77	103	103			
	<b>180 (225-270)x100</b> 70 (89-105)x39 inches	<b>BALV12</b>	<b>3.592</b>	<b>5.202</b>	<b>5.958</b>			
		Kg	79	105	107			
	<b>200 (245-290)x100</b> 78 (97-114)x39 inches	<b>BALV14</b>	<b>3.698</b>	<b>5.401</b>	<b>6.209</b>			
		Kg	82	108	110			
	<b>220 (265-310)x100</b> 85 (105-122)x39 inches	<b>BALV16</b>	<b>3.777</b>	<b>5.574</b>	<b>6.431</b>			
		Kg	82	111	116			

# Bamboo - Fisso

## Bamboo tavolo fisso

Bamboo fixed table

Bamboo table fixe



## Struttura in metallo verniciato

Coated metal frame / Structure en métal laqué

### Finiture struttura opaca di serie:

#### Bianco Gesso - Antracite - Fango

Standard matt frame finishes:  
Chalk White - Anthracite - Mud

Finitions mates standard de la structure :  
Blanc Craie - Anthracite - Boue

### Maggiorazione per colore struttura optional (patella di copertina)

Surcharge for optional frame colour  
(see colour chart on cover)

Supplément pour coloris structure  
optionnel (voir rabat en couverture)

€ 350

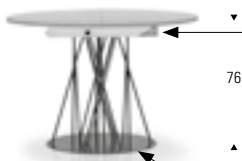

Quadrato 45x45

Square 45x45  
Carré 45x45

76

Diametro 70,5

Diameter 70.5  
Diamètre 70,5



• 120/140 •



Profilo piano ceramica

Ceramic top edge  
Chant plateau céramique



Profilo altri piani

Edge for other tops  
Chant autres plateaux

	M <sup>3</sup>
Ø 120	0,57
Ø 140	0,62



	cod.	Materico Textured matt Texturé	Vetro lucido bianco gesso Gloss Chalk White glass Verre brillant blanc craie	Ceramica Premium Premium Ceramic Céramique Premium			
Sp. Thk/Ép.		2 cm	1 cm	1,4 cm			

## Rotondo

	Ø 120 47 inches	<b>BAMFR1</b>	<b>1.309</b>	<b>2.282</b>	<b>2.727</b>		
		Kg	70	80	80		
	Ø 140 55 inches	<b>BAMFR2</b>	<b>1.416</b>	<b>2.731</b>	<b>3.113</b>		
		Kg	75	85	85		

# Bamboo - Allungabile Book system

## Book system apertura telescopica del piano

Book System mechanism with telescopic tabletop

Book system ouverture télescopique du plateau



## Struttura in metallo verniciato

Coated metal frame / Structure en métal laqué

### Finiture struttura opaca di serie: Bianco Gesso - Antracite - Fango

Standard matt frame finishes: Chalk White - Anthracite - Mud

Finitions mates standard de la structure : Blanc Craie - Anthracite - Boue

### Maggiorazione per colore struttura optional (patella di copertina)

Surcharge for optional frame colour (see colour chart on cover)

Supplément pour coloris structure optionnel (voir rabat en couverture)

€ 350

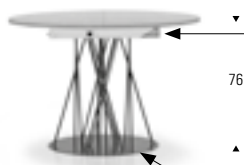

Quadrato 74x67  
Square 74X67  
Carré 74X67

76

Diametro 70,5  
Diameter 70.5  
Diamètre 70,5

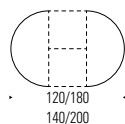

120/180  
140/200



Profilo piano ceramica  
Ceramic top edge  
Chant plateau céramique



Profilo altri piani  
Edge for other tops  
Chant autres plateaux

	M <sup>3</sup>
Ø 120	0,57
Ø 140	0,62



	cod.	Materico Textured matt Texturé	Vetro lucido bianco gesso Gloss glass chalk white Verre brillant blanc craie	Ceramica Elegance Elegance Ceramic Céramique Elegance			
Sp. Thk/Ép.		2 cm	1 cm	1,4 cm			

## Book system



Ø 120 (180)  
47 (70) inches

**BAMBR1**

**2.144**

**3.272**

**4.014**

Kg

88

88

97

Ø 140 (200)  
55 (78) inches

**BAMBR2**

**2.277**

**3.699**

**4.297**

Kg

95

105

116

### Allunghe in tinta con piano in materico. Sulla versione in vetro piano allunghe in materico bianco gesso. Per la versione in ceramica allunghe in materico in tinta con il bordo del piano.

For model with a textured top, the extension leaves are made to match. For models with a glass top, the extension leaves have a textured Chalk White finish. For the ceramic version the extension leaves are in textured matching the colour of the top's edge.

Allonges assorties à la finition du plateau texturé. Pour la version avec plateau en verre, les allonges sont réalisées en texturé blanc craie. Pour la version en céramique, allonges en texturé assorties au chant du plateau.

# Building - Fisso

## Building tavolo fisso

Building fixed table

Building table fixe



## Struttura in metallo verniciato

Coated metal frame / Structure en métal laqué

### Finiture struttura opaca di serie:

**Bianco Gesso - Antracite - Fango**

Standard matt frame finishes:  
Chalk White - Anthracite - Mud

Finitions mates standard de la structure :  
Blanc Craie - Anthracite - Boue

Maggiorazione per colore struttura  
optional (patella di copertina)

Surcharge for optional frame colour  
(see colour chart on cover)

Supplément pour coloris structure  
optionnel (voir rabat en couverture)

€ 350



75

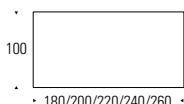

**Profilo piano ceramica**  
Ceramic top edge  
Chant plateau céramique



**Profilo altri piani**  
Edge for other tops  
Chant autres plateaux



**Profilo piano materico  
bordo scaricato**  
Edge of textured top  
with bevelled edge  
Chant plateau texturé incliné

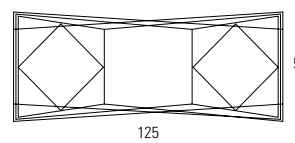





**Ingombro base standard**  
Standard base size  
Encombrement piètement  
standard

	M <sup>3</sup>
180x100/110	0,52
200x100/110	0,62
220x100/120	0,68
240x120/120	0,76
260x120/120	0,81



		<b>Materico</b> Textured matt Texturé	<b>Materico bordo scaricato</b> Textured matt with sloping edge Texturé chant en pente	<b>Vetro trasparente e fumé</b> Clear and smoked glass Verre transparent et fumé	<b>Ceramica Elegance</b> Elegance Ceramic Céramique Elegance	<b>Ceramica Premium</b> Premium Ceramic Céramique Premium	<b>Basamento</b> Base Piètement
Sp. Thk/Ép.	cod.	2 cm	3 cm	1,2 cm	1,4 cm	1,4 cm	

## Rettangolare

	<b>180x100</b> 70x39 inches	<b>BUIF12</b>	-	<b>1.038</b>	<b>1.699</b>	<b>2.013</b>	<b>2.235</b>	<b>781</b>
		Kg		55	105	74	74	51
	<b>200x100</b> 78x39 inches	<b>BUIF14</b>	-	<b>1.077</b>	<b>1.806</b>	<b>2.199</b>	<b>2.381</b>	<b>781</b>
		Kg		62	111	84	84	51
	<b>220x100</b> 85x39 inches	<b>BUIF16</b>	-	<b>1.253</b>	<b>1.944</b>	<b>2.233</b>	<b>2.516</b>	<b>781</b>
		Kg		65	117	88	88	51
	<b>240x100</b> 93x39 inches	<b>BUIF18</b>	-	<b>1.293</b>	<b>2.016</b>	<b>2.516</b>	<b>2.808</b>	<b>781</b>
		Kg		68	123	92	92	51
	<b>260x100</b> 102x39 inches	<b>BUIF20</b>	-	<b>1.328</b>	<b>2.116</b>	<b>2.662</b>	<b>2.884</b>	<b>781</b>
		Kg		71	129	96	96	51

## Botte

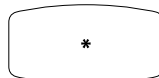
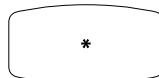
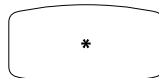
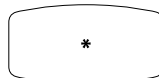
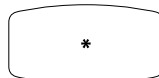
	<b>180x110</b> 70x43 inches	<b>BUIFB3</b>	<b>1.067</b>	-	<b>1.946</b>	<b>3.035 *</b>	<b>3.134</b>	<b>781</b>
		Kg	55		105	74	74	51
	<b>200x110</b> 78x43 inches	<b>BUIFB4</b>	<b>1.087</b>	-	<b>2.051</b>	<b>3.122 *</b>	<b>3.226</b>	<b>781</b>
		Kg	62		111	84	84	51
	<b>220x120</b> 85x47 inches	<b>BUIFB6</b>	<b>1.263</b>	-	<b>2.209</b>	<b>3.192 *</b>	<b>3.292</b>	<b>781</b>
		Kg	65		117	88	88	51
	<b>240x120</b> 93x47 inches	<b>BUIFB7</b>	<b>1.289</b>	-	<b>2.319</b>	<b>3.460 *</b>	<b>3.570</b>	<b>781</b>
		Kg	68		123	92	92	51
	<b>260x120</b> 102x47 inches	<b>BUIFB8</b>	<b>1.334</b>	-	<b>2.396</b>	<b>3.589 *</b>	<b>3.689</b>	<b>781</b>
		Kg	71		129	96	96	51

\* **Ceramica Elegance a botte solo su finitura Urban Marble 034 e Amani 035**

Barrel-shaped Ceramica Elegance only available for Urban Marble 034 and Amani 035 finishes / Forme tonneau en Céramique Elegance uniquement dans les finitions Urban Marble 034 et Amani 035

# Building - Allungabile One system

## One system staffe estraibili con allunghe esterne

One system mechanism with pull-out brackets and external extension leaves

One system bras extractibles avec allonges séparées

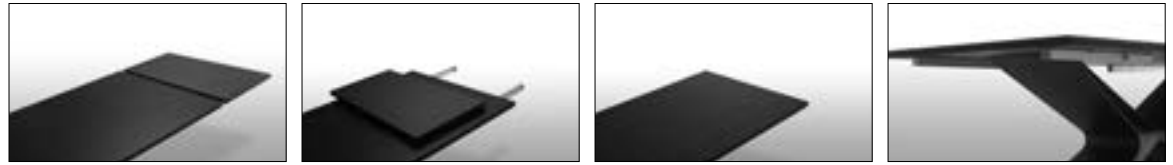

## Struttura in metallo verniciato

Coated metal frame / Structure en métal laqué

### Finiture struttura opaca di serie: Bianco Gesso - Antracite - Fango

Standard matt frame finishes: Chalk White - Anthracite - Mud

Finitions mates standard de la structure: Blanc Craie - Anthracite - Boue

### Maggiorazione per colore struttura optional (patella di copertina)

Surcharge for optional frame colour (see colour chart on cover)

Supplément pour coloris structure optionnel (voir rabat en couverture)

€ 350



75

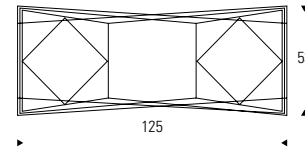
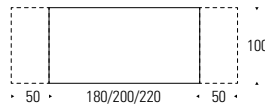

Profilo altri piani  
Edge for other tops  
Chant autres plateaux

Ingombro base standard  
Standard base size  
Encombrement piètement standard

	M <sup>3</sup>
180x100	0,70
200x100	0,70
220x100	0,97



**Materico bordo scaricato**  
Textured matt with sloping edge  
Texturé chant en pente

cod.

Sp. Thk/Ép.

3 cm

## One system

	<b>180 (230-280)x100</b> 70 (90-109)x39 inches	<b>BUI012</b>	<b>1.543</b>				
		Kg	75				
	<b>200 (250-300)x100</b> 78 (95-118)x39 inches	<b>BUI014</b>	<b>1.582</b>				
		Kg	82				
<b>220 (270-320)x100</b> 85 (105-125)x39 inches	<b>BUI016</b>	<b>1.636</b>					
		Kg	85				

## Allunghe in tinta con piano

Extension leaves match the top

Allonges assorties à la finition du plateau

# Building - Allungabile New up system

## New up system

### binario scorrevole e alzabile

New up system mechanism with sliding, lift-up track

New up system rail coulissant et relevable

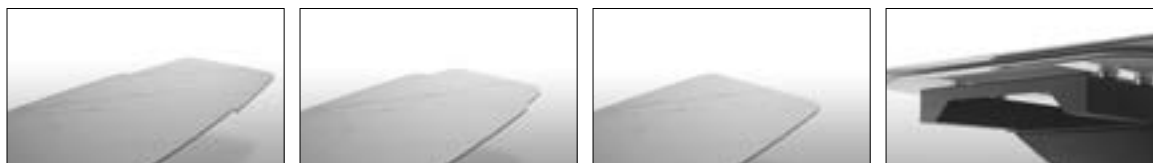

## Struttura in metallo verniciato

Coated metal frame / Structure en métal laqué

### Finiture struttura opaca di serie:

#### Bianco Gesso - Antracite - Fango

Standard matt frame finishes:  
Chalk White - Anthracite - Mud

Finitions mates standard de la structure :  
Blanc Craie - Anthracite - Boue

### Maggiorazione per colore struttura optional (patella di copertina)

Surcharge for optional frame colour (see colour chart on cover)

Supplément pour coloris structure optionnel (voir rabat en couverture)

€ 350

### Maggiorazione su ceramica Premium con allunghe in Bilia

Surcharge for Premium ceramic top with extension leaves in a matching pattern

Supplément pour céramique Premium avec allonges même aspect que plateau

€ 400

### Allunghe ceramica Elegance non disponibile in Bilia

Elegance ceramic extension leaves not available in a matching pattern

Allonges en céramique Elegance non disponibles avec même aspect que le plateau

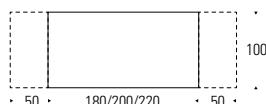

Profilo piano ceramica  
Ceramic top edge  
Chant plateau céramique



Profilo piano materico bordo scaricato  
Edge of textured top with bevelled edge  
Chant plateau texturé incliné



Profilo altri piani  
Edge for other tops  
Chant autres plateaux

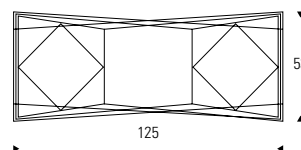

Ingombro base standard  
Standard base size  
Encombrement piètement standard

Indicare nell'ordine il colore del meccanismo se diverso dall'abbinamento consigliato (vedi pag. 6)  
Please specify the colour of the mechanism if it differs from the recommended pairings (see page 6)  
Indiquer dans la commande le coloris du mécanisme s'il est différent de l'association conseillée (voir page 6)

	M <sup>3</sup>
180x100	0,77
200x100	0,77
220x100	1,02



	cod.	Materico bordo scaricato Textured matt with sloping edge Texturé chant en pente	Vetro trasparente e fumé Clear and smoked glass Verre transparent et fumé	Ceramica Elegance Elegance Ceramic Céramique Elegance	Ceramica Premium Premium Ceramic Céramique Premium		
Sp. Thk/Ép.		2 cm	1,2 cm	1,4 cm	1,4 cm		

## New up system

	180 (230-280)x100 70 (90-109)x39 inches	BUIH12	2.269	3.308	3.883	4.177	
		Kg	75	95	102	102	
	200 (250-300)x100 78 (95-118)x39 inches	BUIH14	2.315	3.434	3.977	4.349	
		Kg	82	99	108	108	
	220 (270-320)x100 85 (105-125)x39 inches	BUIH16	2.390	3.536	4.088	4.464	
		Kg	85	103	112	112	

### Allunghe in tinta con piano

Extension leaves match the top

Allonges assorties à la finition du plateau

# Evolution - Allungabile Cross system

## Cross system apertura telescopica della struttura

Cross system opening mechanism with telescopic frame

Cross system ouverture télescopique de la structure

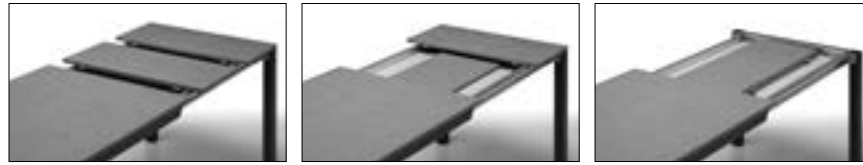

## Struttura in metallo verniciato

Coated metal frame / Structure en métal laqué

### Finiture struttura opaca di serie: Bianco Gesso - Antracite - Fango

Standard matt frame finishes: Chalk White - Anthracite - Mud

Finitions mates standard de la structure: Blanc Craie - Anthracite - Boue

### Maggiorazione per colore struttura optional (patella di copertina)

Surcharge for optional frame colour (see colour chart on cover)

Supplément pour coloris structure optionnel (voir rabat en couverture)

€ 200



76

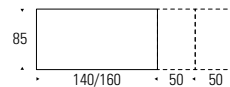
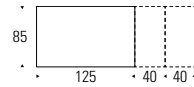

Profilo piano ceramica  
Ceramic top edge  
Chant plateau céramique



Profilo altri piani  
Edge for other tops  
Chant autres plateaux

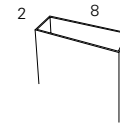



Sezione gamba  
Leg cross-section  
Section pied

	M <sup>3</sup>
125x85	0,20
140x85	0,25
160x85	0,30

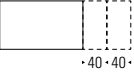
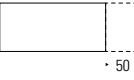

	cod.	Materico Textured matt Texturé	Vetro colorato lucido Gloss lacquered glass Verre coloré brillant	Glass decor	Ceramica Elegance Elegance Ceramic Céramique Elegance		
Sp. Thk/Ép.		1,4 cm	0,8 cm	0,8 cm	1,4 cm		

## Cross system

	<b>125 (165-205)x85</b> 50 (65-81)x37 inches	<b>EVOC81</b>	<b>1.287</b>	<b>1.538</b>	<b>1.547</b>	<b>1.958</b>		
	Kg		42	54	54	56		
	<b>140 (190-240)x85</b> 55 (75-88)x37 inches	<b>EVOC82</b>	<b>1.323</b>	<b>1.666</b>	<b>1.681</b>	<b>2.057</b>		
	Kg		45	58	58	61		
	<b>160 (210-260)x85</b> 62 (80-101)x37 inches	<b>EVOC86</b>	<b>1.345</b>	<b>1.765</b>	<b>1.790</b>	<b>2.217</b>		
	Kg		50	64	64	68		

### Allunghe in tinta con piano in materico. Sulle altre versioni piano allunghe in nobilitato bianco su finiture chiaro e antracite su finiture scure.

For models with a textured top, the extension leaves are made to match. For the other models, the extension leaves have a melamine finish in White where the top finish is pale, and in Anthracite where the top is dark.

Allonges assorties à la finition du plateau. Pour les autres versions de plateau, les allonges sont en mélaminé blanc pour les finitions claires et en mélaminé anthracite pour les finitions foncées.



# Giò - Allungabile Easy book system

## Easy Book system apertura telescopica con allunga a libro

Easy Book System telescopic opening mechanism with folded extension leaves

Easy Book System ouverture télescopique avec allonge papillon



## Struttura in metallo verniciato

Coated metal frame / Structure en métal laqué

### Finiture struttura opaca di serie: Bianco Gesso - Antracite - Fango

Standard matt frame finishes: Chalk White - Anthracite - Mud

Finitions mates standard de la structure: Blanc Craie - Anthracite - Boue



▼  
75  
▲

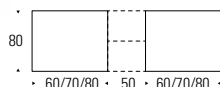

Profilo piano materico  
Textured top edge  
Chant plateau texturé

Profilo piano materico + ceramica  
Textured + ceramic top edge  
Chant plateau texturé + céramique

	M <sup>3</sup>
120x80	0,27
140x80	0,28
160x80	0,28



Materico  
Textured  
Texturé

**Materico**  
Textured matt  
Texturé

**Ceramica Elegance\***  
Elegance Ceramic\*  
Céramique Elegance\*

cod.

Sp. Thk/Ép.

3 cm

3,6 cm

## Easy book system

	<b>120 (170)x80</b> 47 (67)x31 inches	<b>GIOS70</b>	<b>1.093</b>	<b>1.570</b>			
		Kg	36	25			
	<b>140 (190)x80</b> 55 (75)x31 inches	<b>GIOS71</b>	<b>1.128</b>	<b>1.619</b>			
		Kg	40	27			
<b>160 (210)x80</b> 62 (82)x31 inches	<b>GIOS72</b>	<b>1.171</b>	<b>1.681</b>				
		Kg	43	29			

### \* Allunga su piani in ceramica è in materico in tinta con il bordo del piano

Extension leaves for ceramic tops are textured and match the colour of the top's edge

L'allonge des plateaux en céramique est réalisée en texturé assorti au chant du plateau

# Ikarus - Fisso

## Ikarus tavolo fisso

Ikarus fixed table

Ikarus table fixe

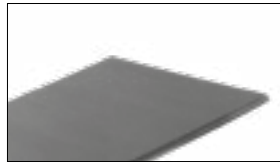

## Struttura in metallo verniciato

Coated metal frame / Structure en métal laqué

### Finiture struttura opaca di serie: Bianco Gesso - Antracite - Fango

Standard matt frame finishes:  
Chalk White - Anthracite - Mud

Finitions mates standard de la structure :  
Blanc Craie - Anthracite - Boue

### Maggiorazione per colore struttura optional (patella di copertina)

Surcharge for optional frame colour  
(see colour chart on cover)

Supplément pour coloris structure  
optionnel (voir rabat en couverture)

€ 500

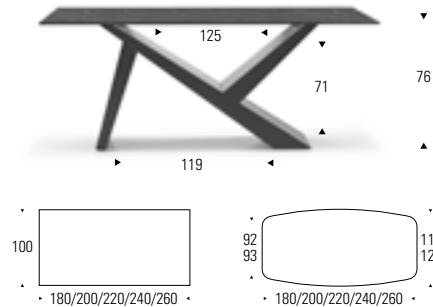

Profilo piano ceramica  
Ceramic top edge  
Chant plateau céramique



Profilo piano materico  
bordo scaricato  
Edge of textured top  
with bevelled edge  
Chant plateau texturé incliné



Profilo altri piani  
Edge for other tops  
Chant autres plateaux

	M <sup>3</sup>
180x100/110	0,72
200x100/110	0,80
220x100/120	0,85
240x100/120	0,90
260x100/120	1,00



		Materico Textured matt Texturé	Materico bordo scaricato Textured matt with sloping edge Texturé chant en pente	Vetro trasparente e fumé Clear and smoked glass Verre transparent et fumé	Ceramica Elegance Elegance Ceramic Céramique Elegance	Ceramica Premium Premium Ceramic Céramique Premium	Basamento Base Piètement
	cod.						
	Sp. Thk/Ép.	2 cm	3 cm	1,2 cm	1,4 cm		

## Rettangolare

	<b>180x100</b> 70x39 inches	<b>IKAF12</b>	-	<b>1.833</b>	<b>2.566</b>	<b>2.794</b>	<b>3.022</b>	<b>1.540</b>
		Kg		72	91	91	91	38
	<b>200x100</b> 78x39 inches	<b>IKAF14</b>	-	<b>1.873</b>	<b>2.657</b>	<b>2.981</b>	<b>3.245</b>	<b>1.540</b>
		Kg		76	97	97	97	38
	<b>220x100</b> 85x39 inches	<b>IKAF16</b>	-	<b>2.048</b>	<b>2.797</b>	<b>3.099</b>	<b>3.396</b>	<b>1.540</b>
		Kg		80	103	103	103	38
	<b>240x100</b> 93x39 inches	<b>IKAF18</b>	-	<b>2.087</b>	<b>2.924</b>	<b>3.329</b>	<b>3.658</b>	<b>1.540</b>
		Kg		84	110	110	110	38
	<b>260x100</b> 102x39 inches	<b>IKAF20</b>	-	<b>2.122</b>	<b>3.028</b>	<b>3.447</b>	<b>3.722</b>	<b>1.540</b>
		Kg		88	117	117	117	38

## Botte

	<b>180x110</b> 70x43 inches	<b>IKAFB3</b>	<b>1.862</b>	-	<b>2.879</b>	<b>3.823*</b>	<b>3.929</b>	<b>1.540</b>
		Kg	72		91	91	91	38
	<b>200x110</b> 78x43 inches	<b>IKAFB4</b>	<b>1.881</b>	-	<b>2.988</b>	<b>3.915*</b>	<b>4.020</b>	<b>1.540</b>
		Kg	76		97	97	97	38
	<b>220x120</b> 85x47 inches	<b>IKAFB6</b>	<b>2.057</b>	-	<b>3.153</b>	<b>3.986*</b>	<b>4.086</b>	<b>1.540</b>
		Kg	80		103	103	103	38
	<b>240x120</b> 93x47 inches	<b>IKAFB7</b>	<b>2.083</b>	-	<b>3.266</b>	<b>4.254*</b>	<b>4.364</b>	<b>1.540</b>
		Kg	84		110	110	110	38
	<b>260x120</b> 102x47 inches	<b>IKAFB8</b>	<b>2.128</b>	-	<b>3.347</b>	<b>4.383*</b>	<b>4.483</b>	<b>1.540</b>
		Kg	88		117	117	117	38

### \* Ceramica Elegance a botte solo su finitura Urban Marble 034 e Amani 035

Barrel-shaped Ceramica Elegance only available for Urban Marble 034 and Amani 035 finishes / Forme tonneau en Céramique Elegance uniquement dans les finitions Urban Marble 034 et Amani 035

# Ikarus - Allungabile New up system

## New up system

### binario scorrevole e alzabile

New up system mechanism with sliding, lift-up track

New up system rail coulissant et relevable

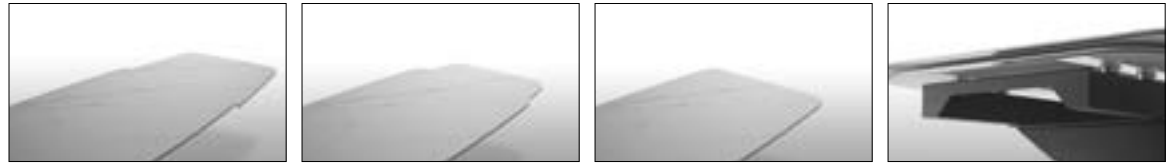

## Struttura in metallo verniciato

Coated metal frame / Structure en métal laqué

### Finiture struttura opaca di serie: Bianco Gesso - Antracite - Fango

Standard matt frame finishes: Chalk White - Anthracite - Mud

Finitions mates standard de la structure: Blanc Craie - Anthracite - Boue

### Maggiorazione per colore struttura optional (patella di copertina)

Surcharge for optional frame colour (see colour chart on cover)

Supplément pour coloris structure optionnel (voir rabat en couverture)

€ 500

### Maggiorazione su ceramica Premium con allunghe in Bilia

Surcharge for Premium ceramic top with extension leaves in a matching pattern

Supplément pour céramique Premium avec allonges même aspect que plateau

€ 400

### Allunghe ceramica Elegance non disponibile in Bilia

Elegance ceramic extension leaves not available in a matching pattern

Allonges en céramique Elegance non disponibles avec même aspect que le plateau

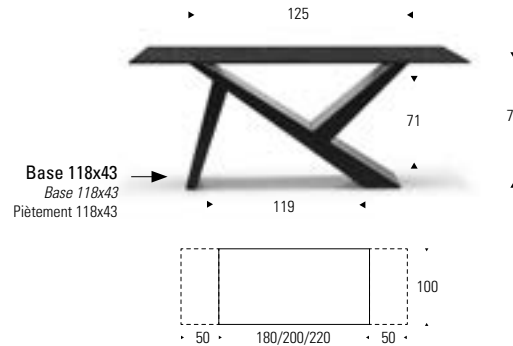

**Profilo piano ceramica**  
Ceramic top edge  
Chant plateau céramique



**Profilo piano materico bordo scaricato**  
Edge of textured top with bevelled edge  
Chant plateau texturé incliné



**Profilo altri piani**  
Edge for other tops  
Chant autres plateaux

Indicare nell'ordine il colore del meccanismo se diverso dall'abbinamento consigliato (vedi pag. 6)  
Please specify the colour of the mechanism if it differs from the recommended pairings (see page 6)  
Indiquer dans la commande le coloris du mécanisme s'il est différent de l'association conseillée (voir page 6)

	M <sup>3</sup>
180x100	0,72
200x100	0,80
220x100	1,00



	cod.	Materico bordo scaricato Textured matt with sloping edge Texturé chant en pente	Vetro trasparente e fumé Clear and smoked glass Verre transparent et fumé	Ceramica Elegance Elegance Ceramic Céramique Elegance	Ceramica Premium Premium Ceramic Céramique Premium		
Sp. Thk/Ép.		1,2 cm	1,2 cm	1,4 cm	1,4 cm		

## New up system

	180 (230-280)x100 70 (90-109)x39 inches	200 (250-300)x100 78 (95-118)x39 inches	220 (270-320)x100 85 (105-125)x39 inches				
	<b>IKAH12</b>	<b>IKAH14</b>	<b>IKAH16</b>	<b>3.063</b>	<b>4.227</b>	<b>4.678</b>	<b>4.971</b>
	Kg	Kg	Kg	91	135	135	135
				<b>3.110</b>	<b>4.355</b>	<b>4.771</b>	<b>5.140</b>
				95	146	146	146
				<b>3.184</b>	<b>4.461</b>	<b>4.882</b>	<b>5.258</b>
				99	156	156	156

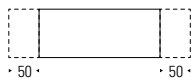

# Movida - Allungabile Cross system

## Cross system apertura telescopica della struttura

Cross system opening mechanism with telescopic frame

Cross system ouverture télescopique de la structure

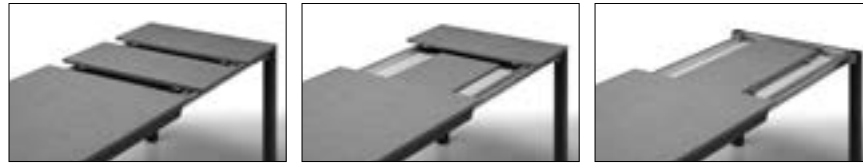

## Struttura in metallo verniciato

Coated metal frame / Structure en métal laqué

### Finiture struttura opaca di serie: Bianco Gesso - Antracite - Fango

Standard matt frame finishes: Chalk White - Anthracite - Mud

Finitions mates standard de la structure : Blanc Craie - Anthracite - Boue

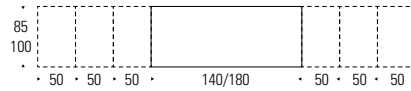

	M <sup>3</sup>
140x85	0,38
180x100	0,49



**Materico**  
Textured matt  
Texturé

cod.

Sp. Thk/Ép.

1,4 cm

## Cross system

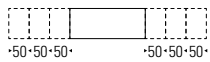

**140 (190-240-290-340-390-440)x85**

62 (75-93-114-134-154-173)x37 inches

**MOVC82**

**2.525**

Kg

95

**180 (230-280-330-380-430-480)x100**

70 (90-109-130-150-169-189)x39 inches

**MOVC12**

**2.734**

Kg

101

# Olimpo - Allungabile Easy book system

**In eliminazione**  
Available until stocks last  
En cours d'élimination

## Easy Book system apertura telescopica con allunga a libro

*Easy Book System telescopic opening mechanism with folded extension leaves*

Easy Book System ouverture télescopique avec allonge papillon



## Struttura in metallo verniciato

*Coated metal frame / Structure en métal laqué*

### Finiture struttura opaca di serie: Bianco Gesso - Antracite - Fango

*Standard matt frame finishes: Chalk White - Anthracite - Mud*

*Finitions mates standard de la structure: Blanc Craie - Anthracite - Boue*



▼

75

▲

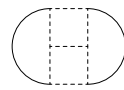

• 120/165  
140/185

3 :

**Profilo piani**  
*Top edge*  
Chant plateaux

0,6 :

**Profilo piano materico + ceramica**  
*Textured + ceramic top edge*  
Chant plateau texturé + céramique

	M <sup>3</sup>
Ø 120	0,48
Ø 140	0,49



Materico  
Textured  
Texturé

**Materico**  
*Textured matt*  
Texturé

**Ceramica Elegance\***  
*Elegance Ceramic\**  
Céramique Elegance\*

cod.

Sp. Thk/Ép.

3 cm

3,6 cm

## Easy book system

	Ø 120 (165) 47 (65) inches	OLISR1	1.210	2.291 *			
			Kg	58	58		
	Ø 140 (185) 55 (72) inches	OLISR2	1.305	2.717 *			
		Kg	68	68			

### \* Disponibile solo ceramica fokus piombo e fokus terra.

### Allunga su piani in ceramica è in materico cemento cava.

*Only Fokus Lead and Fokus Umber ceramics are available.  
The extension leaf for ceramic tops is in textured quarry cement.*

*Existe uniquement en céramique fokus plomb et fokus terre.  
L'allonge des plateaux en céramique est réalisée en texturé ciment carrière.*

# Origami - Fisso

## Origami tavolo fisso

Origami fixed table

Origami table fixe

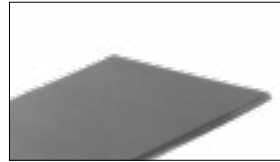

### Struttura in metallo verniciato

Coated metal frame / Structure en métal laqué

#### Finiture struttura opaca di serie: Bianco Gesso - Antracite - Fango

Standard matt frame finishes:  
Chalk White - Anthracite - Mud

Finitions mates standard de la structure :  
Blanc Craie - Anthracite - Boue

#### Maggiorazione per 1 gamba in contrasto

Surcharge for 1 contrasting leg

Supplément pour 1 pied en contraste

€ 200

#### Maggiorazione per colore struttura optional (patella di copertina)

Surcharge for optional frame colour  
(see colour chart on cover)

Supplément pour coloris structure  
optionnel (voir rabat en couverture)

€ 350

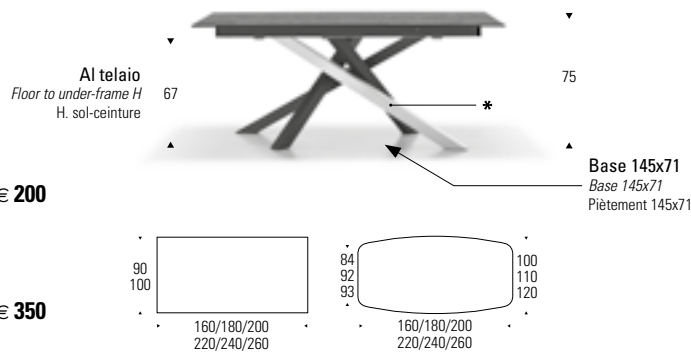

Profilo piano ceramica  
Ceramic top edge  
Chant plateau céramique



Profilo piano materico  
bordo scaricato  
Edge of textured top  
with bevelled edge  
Chant plateau texturé incliné



Profilo altri piani  
Edge for other tops  
Chant autres plateaux

\* Gamba in finitura personalizzabile  
(esempi gamba in contrasto a catalogo pag. 110)  
The finish of the leg can be customised  
(for examples of contrasting legs, see catalogue on page 110)  
Pied avec finition personnalisable (exemples de pied  
en contraste dans le catalogue page 110)

	M <sup>3</sup>		Materico Textured matt Texturé	Materico bordo scaricato Textured matt with sloping edge Texturé chant en pente	Ceramica Elegance Elegance Ceramic Céramique Elegance	Ceramica Premium Premium Ceramic Céramique Premium	Basamento Base Piètement
160x90/100	0,90		cod.	2 cm	3 cm	1,4 cm	1,4 cm
180x100/110	1,00						
200x100/110	1,10						
220x100/120	1,20						
240x100/120	1,30						
260x100/120	1,40						
Sp. Thk/Ép.							

## Rettangolare

<b>160x90</b> 63x36 inches	<b>ORIF10</b>	-	<b>1.095</b>	<b>1.975</b>	<b>2.243</b>	<b>849</b>
	Kg		52	72	72	21
<b>180x100</b> 70x39 inches	<b>ORIF12</b>	-	<b>1.154</b>	<b>2.152</b>	<b>2.373</b>	<b>849</b>
	Kg		55	74	74	21
<b>200x100</b> 78x39 inches	<b>ORIF14</b>	-	<b>1.192</b>	<b>2.250</b>	<b>2.519</b>	<b>849</b>
	Kg		62	84	84	21
<b>220x100</b> 85x39 inches	<b>ORIF16</b>	-	<b>1.364</b>	<b>2.372</b>	<b>2.655</b>	<b>849</b>
	Kg		65	88	88	21
<b>240x100</b> 94x39 inches	<b>ORIF18</b>	-	<b>1.402</b>	<b>2.655</b>	<b>2.946</b>	<b>849</b>
	Kg		68	92	92	21
<b>260x100</b> 101x39 inches	<b>ORIF20</b>	-	<b>1.436</b>	<b>2.801</b>	<b>3.022</b>	<b>849</b>
	Kg		71	96	96	21

## Botte

<b>160x100</b> 63x36 inches	<b>ORIFB2</b>	<b>1.141</b>	-	<b>2.387</b>	<b>2.440</b>	<b>849</b>
	Kg		52	72	72	21
<b>180x110</b> 70x43 inches	<b>ORIFB3</b>	<b>1.206</b>	-	<b>3.167*</b>	<b>3.273</b>	<b>849</b>
	Kg		55	74	74	21
<b>200x110</b> 78x43 inches	<b>ORIFB4</b>	<b>1.226</b>	-	<b>3.260*</b>	<b>3.364</b>	<b>849</b>
	Kg		62	84	84	21
<b>220x120</b> 85x47 inches	<b>ORIFB6</b>	<b>1.402</b>	-	<b>3.330*</b>	<b>3.430</b>	<b>849</b>
	Kg		65	88	88	21
<b>240x120</b> 94x47 inches	<b>ORIFB7</b>	<b>1.427</b>	-	<b>3.599*</b>	<b>3.709</b>	<b>849</b>
	Kg		68	92	92	21
<b>260x120</b> 101x47 inches	<b>ORIFB8</b>	<b>1.472</b>	-	<b>3.727*</b>	<b>3.827</b>	<b>849</b>
	Kg		71	96	96	21

### \* Ceramica Elegance a botte solo su finitura Urban Marble 034 e Amani 035

Barrel-shaped Ceramica Elegance only available for Urban Marble 034 and Amani 035 finishes / Forme tonneau en Céramique Elegance uniquement dans les finitions Urban Marble 034 et Amani 035

# Origami - Allungabile One system

## One system staffe estraibili con allunghe esterne

One system mechanism with pull-out brackets and external extension leaves

One system bras extractibles avec allonges séparées

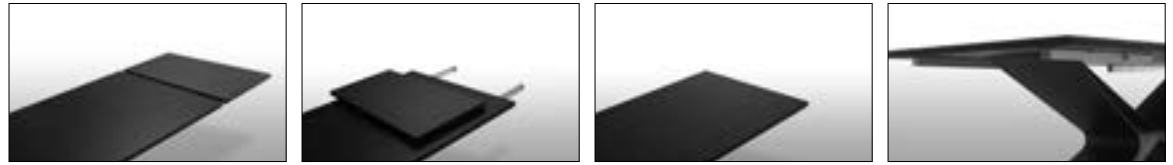

## Struttura in metallo verniciato

Coated metal frame / Structure en métal laqué

### Finiture struttura opaca di serie: Bianco Gesso - Antracite - Fango

Standard matt frame finishes: Chalk White - Anthracite - Mud

Finitions mates standard de la structure: Blanc Craie - Anthracite - Boue

### Maggiorazione per 1 gamba in contrasto

Surcharge for 1 contrasting leg

Supplément pour 1 pied en contraste

### Maggiorazione per colore struttura optional (patella di copertina)

Surcharge for optional frame colour (see colour chart on cover)

Supplément pour coloris structure optionnel (voir rabat en couverture)

Al telaio  
Floor to under-frame H  
H. sol-ceinture

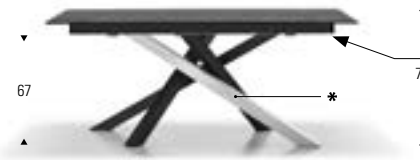

Cassa con telaio 135x60  
Leaf container with frame, 135x60  
Caisson allonges avec mécanisme 135x60

Profilo altri piani  
Edge for other tops  
Chant autres plateaux

€ 200

€ 350

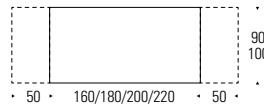

\* Gamba in finitura personalizzabile (esempi gamba in contrasto a catalogo pag. 110)  
The finish of the leg can be customised (for examples of contrasting legs, see catalogue on page 110)  
Pied avec finition personnalisable (exemples de pied en contraste dans le catalogue page 110)

	M <sup>3</sup>
160x90	1,04
180x100	1,14
200x100	1,24
220x100	1,34



Materico  
Textured  
Texturé

Materico  
bordo scaricato  
Textured matt  
with sloping edge  
Texturé  
chant en pente

cod.

Sp. Thk/Ép.

3 cm

## One system

	<b>160 (210-260)x90</b> 63 (82-102)x36 inches	<b>ORIO10</b>	<b>1.611</b>				
		Kg	74				
	<b>180 (230-280)x100</b> 70 (90-109)x39 inches	<b>ORIO12</b>	<b>1.681</b>				
		Kg	78				
	<b>200 (250-300)x100</b> 78 (95-118)x39 inches	<b>ORIO14</b>	<b>1.721</b>				
	Kg	82					
	<b>220 (270-320)x100</b> 85 (105-125)x39 inches	<b>ORIO16</b>	<b>1.775</b>				
	Kg	85					

# Origami - Allungabile New up system

## New up system

### binario scorrevole e alzabile

New up system mechanism with sliding, lift-up track

New up system rail coulissant et relevable

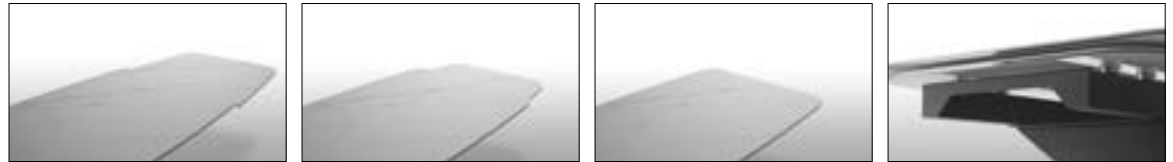

## Struttura in metallo verniciato

Coated metal frame / Structure en métal laqué

### Finiture struttura opaca di serie: Bianco Gesso - Antracite - Fango

Standard matt frame finishes: Chalk White - Anthracite - Mud

Finitions mates standard de la structure: Blanc Craie - Anthracite - Boue

### Maggiorazione per 1 gamba in contrasto

Surcharge for 1 contrasting leg

Supplément pour 1 pied en contraste

### Maggiorazione per colore struttura optional (patella di copertina)

Surcharge for optional frame colour (see colour chart on cover)

Supplément pour coloris structure optionnel (voir rabat en couverture)

### Maggiorazione su ceramica Premium con allunghe in Bilia

Surcharge for Premium ceramic top with extension leaves in a matching pattern

Supplément pour céramique Premium avec allonges même aspect que plateau

### Allunghe ceramica Elegance non disponibile in Bilia

Elegance ceramic extension leaves not available in a matching pattern  
Allonges en céramique Elegance non disponibles avec même aspect que le plateau



Al telaio  
Floor to under-frame H  
H. sol-ceinture



Profilo piano ceramica  
Ceramic top edge  
Chant plateau céramique



Profilo piano materico bordo scaricato  
Edge of textured top with bevelled edge  
Chant plateau texturé incliné

### \* Gamba in finitura personalizzabile (esempi gamba in contrasto a catalogo pag. 110)

The finish of the leg can be customised (for examples of contrasting legs, see catalogue on page 110)  
Pied avec finition personnalisable (exemples de pied en contraste dans le catalogue page 110)

Indicare nell'ordine il colore del meccanismo se diverso dall'abbinamento consigliato (vedi pag. 6)  
Please specify the colour of the mechanism if it differs from the recommended pairings (see page 6)  
Indiquer dans la commande le coloris du mécanisme s'il est différent de l'association conseillée (voir page 6)

	M <sup>3</sup>
160x90	1,04
180x100	1,14
200x100	1,24
220x100	1,34



cod.	Materico bordo scaricato Textured matt with sloping edge Texturé chant en pente	Ceramica Elegance Elegance Ceramic Céramique Elegance	Ceramica Premium Premium Ceramic Céramique Premium			
Sp. Thk/Ép.	2 cm	1,4 cm	1,4 cm			

## New up system

Diagram	Dimensions	Code	Price	Weight	Price	Price		
	160 (200-240)x90 63 (79-95)x36 inches	ORIH10	2.313	74 Kg	3.850	4.094		
	180 (230-280)x100 70 (90-109)x39 inches	ORIH12	2.407	78 Kg	4.022	4.316		
	200 (250-300)x100 78 (95-118)x39 inches	ORIH14	2.453	82 Kg	4.116	4.487		
	220 (270-320)x100 85 (105-125)x39 inches	ORIH16	2.528	85 Kg	4.227	4.603		



# Oscar - Fisso

## Oscar tavolo fisso

Oscar fixed table

Oscar table fixe

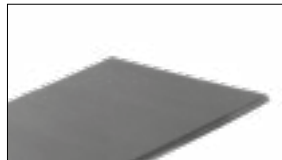

## Struttura in metallo verniciato

Coated metal frame / Structure en métal laqué

### Finiture struttura opaca di serie: Bianco Gesso - Antracite - Fango

Standard matt frame finishes:  
Chalk White - Anthracite - Mud

Finitions mates standard de la structure :  
Blanc Craie - Anthracite - Boue

### Maggiorazione per colore struttura optional (patella di copertina)

Surcharge for optional frame colour  
(see colour chart on cover)

Supplément pour coloris structure  
optionnel (voir rabat en couverture)

€ 200



▼

76

▲

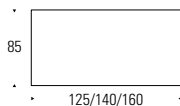

Profilo piano ceramica  
Ceramic top edge  
Chant plateau céramique



Profilo altri piani  
Edge for other tops  
Chant autres plateaux

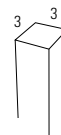

Sezione gamba  
Leg cross-section  
Section pied

	M <sup>3</sup>
125x85	0,22
140x85	0,24
160x85	0,26



cod.	Materico Textured matt Texturé	Vetro colorato lucido Gloss lacquered glass Verre coloré brillant	Glass decor	Ceramica Elegance Elegance Ceramic Céramique Elegance		
Sp. Thk/Ép.	1,4 cm	0,8 cm	0,8 cm	1,4 cm		

## Rettangolare

	<b>125x85</b> 49x33 inches	<b>OSCF81</b>	<b>915</b>	<b>1.282</b>	<b>1.326</b>	<b>1.704</b>	
		Kg	48	53	53	56	
	<b>140x85</b> 55x33 inches	<b>OSCF82</b>	<b>937</b>	<b>1.347</b>	<b>1.397</b>	<b>1.789</b>	
		Kg	52	58	58	61	
	<b>160x85</b> 63x33 inches	<b>OSCF86</b>	<b>961</b>	<b>1.429</b>	<b>1.490</b>	<b>2.053</b>	
		Kg	57	62	62	68	

# Oscar - Allungabile Cross system

## Cross system apertura telescopica della struttura

Cross system opening mechanism with telescopic frame

Cross system ouverture télescopique de la structure



## Struttura in metallo verniciato

Coated metal frame / Structure en métal laqué

### Finiture struttura opaca di serie: Bianco Gesso - Antracite - Fango

Standard matt frame finishes: Chalk White - Anthracite - Mud

Finitions mates standard de la structure: Blanc Craie - Anthracite - Boue

### Maggiorazione per colore struttura optional (patella di copertina)

Surcharge for optional frame colour (see colour chart on cover)

Supplément pour coloris structure optionnel (voir rabat en couverture)

€ 200

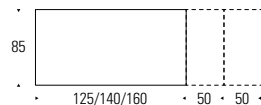

Profilo piano ceramica  
Ceramic top edge  
Chant plateau céramique

Profilo altri piani  
Edge for other tops  
Chant autres plateaux

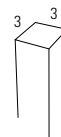

Sezione gamba  
Leg cross-section  
Section pied

	M <sup>3</sup>
125x85	0,22
140x85	0,24
160x85	0,26



		Materico Textured matt Texturé	Vetro colorato lucido Gloss lacquered glass Verre coloré brillant	Glass decor	Ceramica Elegance Elegance Ceramic Céramique Elegance		
	cod.						
	Sp. Thk/Ép.	1,4 cm	0,8 cm	0,8 cm	1,4 cm		

## Cross system

	<b>125 (175-225)x85</b> 50 (69-89)x33 inches	<b>OSCC81</b>	<b>1.221</b>	<b>1.528</b>	<b>1.590</b>	<b>1.853</b>	
		Kg	58	63	63	56	
	<b>140 (190-240)x85</b> 55 (75-94)x33 inches	<b>OSCC82</b>	<b>1.265</b>	<b>1.628</b>	<b>1.699</b>	<b>1.966</b>	
		Kg	62	68	68	61	
	<b>160 (210-260)x85</b> 63 (82-102)x36 inches	<b>OSCC86</b>	<b>1.296</b>	<b>1.720</b>	<b>1.799</b>	<b>2.152</b>	
		Kg	67	72	72	68	

### Allunghe in tinta con piano in materico. Sulle altre versioni piano allunghe in nobilitato bianco su finiture chiaro e antracite su finiture scure.

For models with a textured top, the extension leaves are made to match. For the other models, the extension leaves have a melamine finish in White where the top finish is pale, and in Anthracite where the top is dark. Allonges assorties à la finition du plateau. Pour les autres versions de plateau, les allonges sont en mélaminé blanc pour les finitions claires et en mélaminé anthracite pour les finitions foncées.

# Sail - Fisso

## Sail tavolo fisso

Sail fixed table

Sail table fixe

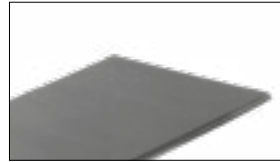

## Struttura in metallo verniciato

Coated metal frame / Structure en métal laqué

### Finiture struttura opaca di serie: Bianco Gesso - Antracite - Fango

Standard matt frame finishes:  
Chalk White - Anthracite - Mud

Finitions mates standard de la structure :  
Blanc Craie - Anthracite - Boue

### Maggiorazione per colore struttura optional (patella di copertina)

Surcharge for optional frame colour  
(see colour chart on cover)

Supplément pour coloris structure  
optionnel (voir rabat en couverture)

€ 500

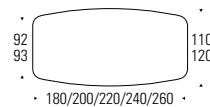
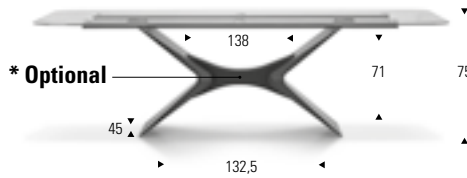

Profilo piano ceramica  
Ceramic top edge  
Chant plateau céramique



Profilo altri piani  
Edge for other tops  
Chant autres plateaux



Profilo piano materico  
bordo scaricato  
Edge of textured top  
with bevelled edge  
Chant plateau texturé incliné

### \* Optional

Maggiorazione per inserto centrale del basamento in finitura  
ecopelle vintage (indicare il colore)

Surcharge for vintage eco-leather central insert on the base (please  
specify the colour)

Supplément pour élément d'union central du piètement finition écocoir  
vintage (indiquer la couleur)

€ 220

	M <sup>3</sup>
180x100/110	0,80
200x100/110	0,85
220x100/120	0,90
240x100/120	1,10
260x100/120	1,23



Sp. Thk/Ép.	cod.	Materico Textured matt Texturé	Materico bordo scaricato Textured matt with sloping edge Texturé chant en pente	Vetro trasparente e fumé Clear and smoked glass Verre transparent et fumé	Glass decor	Ceramica Elegance Elegance Ceramic Céramique Elegance	Ceramica Premium Premium Ceramic Céramique Premium	Basamento (senza inserto) Base (no insert) Piètement (sans élément d'union)
		2 cm	3 cm	1,2 cm	1,2 cm	1,4 cm	1,4 cm	

## Rettangolare

	<b>180x100</b> 70x39 inches	<b>SAIF12</b>	-	<b>1.713</b>	<b>2.347</b>	<b>2.505</b>	<b>2.712</b>	<b>2.932</b>	<b>1.463</b>
		Kg		79	98		103	103	52
	<b>200x100</b> 78x39 inches	<b>SAIF14</b>	-	<b>1.751</b>	<b>2.434</b>	<b>2.611</b>	<b>2.809</b>	<b>3.068</b>	<b>1.463</b>
		Kg		83	104		109	109	52
	<b>220x100</b> 85x39 inches	<b>SAIF16</b>	-	<b>1.923</b>	<b>2.567</b>	<b>2.831</b>	<b>2.931</b>	<b>3.214</b>	<b>1.463</b>
		Kg		87	110		115	115	52
	<b>240x100</b> 93x39 inches	<b>SAIF18</b>	-	<b>1.961</b>	<b>2.636</b>	<b>2.866</b>	<b>3.214</b>	<b>3.505</b>	<b>1.463</b>
		Kg		90	116		122	122	52
	<b>260x100</b> 102x39 inches	<b>SAIF20</b>	-	<b>1.995</b>	<b>2.732</b>	<b>2.996</b>	<b>3.360</b>	<b>3.581</b>	<b>1.463</b>
		Kg		94	122		129	129	52

## Botte

	<b>180x110</b> 70x43 inches	<b>SAIFB3</b>	<b>1.765</b>	-	<b>2.569</b>	<b>2.754</b>	<b>* 3.726</b>	<b>3.832</b>	<b>1.463</b>
		Kg	72		98		103	103	52
	<b>200x110</b> 78x43 inches	<b>SAIFB4</b>	<b>1.785</b>	-	<b>2.670</b>	<b>2.882</b>	<b>* 3.819</b>	<b>3.923</b>	<b>1.463</b>
		Kg	76		104		109	109	52
	<b>220x120</b> 85x47 inches	<b>SAIFB6</b>	<b>1.939</b>	-	<b>2.822</b>	<b>3.093</b>	<b>* 3.889</b>	<b>3.989</b>	<b>1.463</b>
		Kg	80		110		115	115	52
	<b>240x120</b> 93x47 inches	<b>SAIFB7</b>	<b>1.986</b>	-	<b>2.928</b>	<b>3.225</b>	<b>* 4.157</b>	<b>4.267</b>	<b>1.463</b>
		Kg	84		116		122	122	52
	<b>260x120</b> 102x47 inches	<b>SAIFB8</b>	<b>2.031</b>	-	<b>3.001</b>	<b>3.360</b>	<b>* 4.286</b>	<b>4.386</b>	<b>1.463</b>
		Kg	88		122		129	129	52

### \* Ceramica Elegance a botte solo su finitura Urban Marble 034 e Amani 035

Barrel-shaped Ceramica Elegance only available for Urban Marble 034 and Amani 035 finishes / Forme tonneau en Céramique Elegance uniquement dans les finitions Urban Marble 034 et Amani 035

# Sail - Allungabile One system

## One system staffe estraibili con allunghe esterne

One system mechanism with pull-out brackets and external extension leaves

One system bras extractibles avec allonges séparées

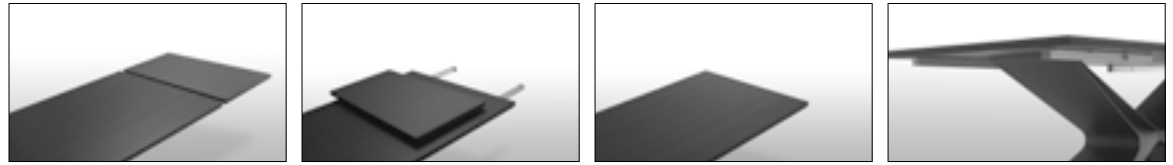

## Struttura in metallo verniciato

Coated metal frame / Structure en métal laqué

### Finiture struttura opaca di serie: Bianco Gesso - Antracite - Fango

Standard matt frame finishes: Chalk White - Anthracite - Mud

Finitions mates standard de la structure : Blanc Craie - Anthracite - Boue

### Maggiorazione per colore struttura optional (patella di copertina)

Surcharge for optional frame colour (see colour chart on cover)

Supplément pour coloris structure optionnel (voir rabat en couverture)

€ 500

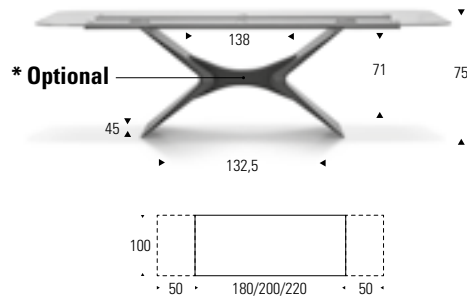

Profilo piano materico bordo scaricato  
Edge of textured top with bevelled edge  
Chant plateau texturé incliné

### \* Optional

Maggiorazione per inserto centrale del basamento in finitura ecopelle vintage (indicare il colore)

Surcharge for vintage eco-leather central insert on the base (please specify the colour)

Supplément pour élément d'union central du piètement finition écocuir vintage (indiquer la couleur)

€ 220

	M <sup>3</sup>
180x100	0,80
200x100	0,85
220x100	1,00



	cod.	Materico bordo scaricato Textured matt with sloping edge Texturé chant en pente					
Sp. Thk/Ép.		3 cm					

## One system

	<b>180 (230-280)x100</b> 70 (90-109)x39 inches	<b>SAI012</b>	<b>2.240</b>				
		Kg	73				
	<b>200 (250-300)x100</b> 78 (95-118)x39 inches	<b>SAI014</b>	<b>2.280</b>				
		Kg	76				
<b>220 (270-320)x100</b> 85 (105-125)x39 inches	<b>SAI016</b>	<b>2.334</b>					
		Kg	78				

# Sail - Allungabile New up system

## New up system

binario scorrevole e alzabile

*New up system mechanism with sliding, lift-up track*

New up system rail coulissant et relevable

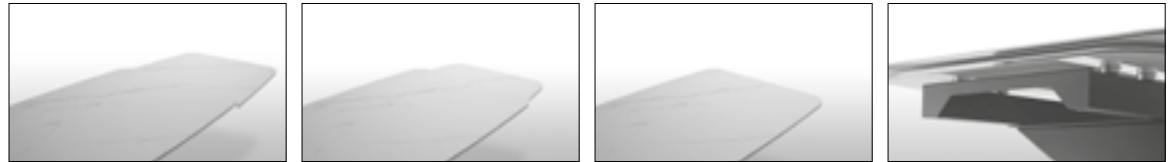

## Struttura in metallo verniciato

*Coated metal frame / Structure en métal laqué*

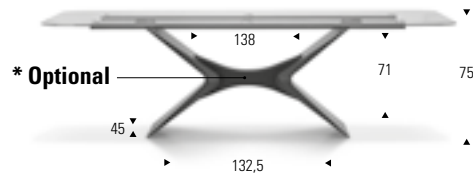

\* **Optional**

€ 500

€ 400

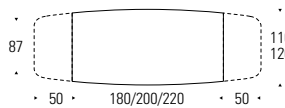
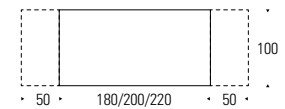

**Profilo piano ceramica**  
*Ceramic top edge*  
Chant plateau céramique



**Profilo piano materico bordo scaricato**  
*Edge of textured top with bevelled edge*  
Chant plateau texturé incliné



**Profilo altri piani**  
*Edge for other tops*  
Chant autres plateaux

\* **Optional**

Maggiorazione per inserto centrale del basamento in finitura ecopelle vintage (indicare il colore)

*Surcharge for vintage eco-leather central insert on the base (please specify the colour)*

Supplément pour élément d'union central du piètement finition écocuir vintage (indiquer la couleur)

€ 220

Indicare nell'ordine il colore del meccanismo se diverso dall'abbinamento consigliato (vedi pag. 6)

*Please specify the colour of the mechanism if it differs from the recommended pairings (see page 6)*

Indiquer dans la commande le coloris du mécanisme s'il est différent de l'association conseillée (voir page 6)

	M <sup>3</sup>
180x100/110	0,85
200x100/110	1,14
220x100/120	1,24



		<b>Materico</b> <i>Textured matt</i> Texturé	<b>Materico bordo scaricato</b> <i>Textured matt with sloping edge</i> Texturé chant en pente	<b>Vetro trasparente e fumé</b> <i>Clear and smoked glass</i> Verre transparent et fumé	<b>Glass decor</b>	<b>Ceramica Elegance</b> <i>Elegance Ceramic</i> Céramique Elegance	<b>Ceramica Premium</b> <i>Premium Ceramic</i> Céramique Premium
	cod.						
	Sp. Thk/Ép.	2 cm	2 cm	1,2 cm	1,2 cm	1,4 cm	1,4 cm

## New up system Rettangolare

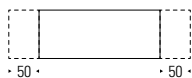

<b>180 (230-280)x100</b> 70 (90-109)x39 inches	<b>SAIH12</b>	-	<b>2.876</b>	<b>4.007</b>	<b>4.241</b>	<b>4.581</b>	<b>4.875</b>
	Kg		90	95	95	117	117
<b>200 (250-300)x100</b> 78 (95-118)x39 inches	<b>SAIH14</b>	-	<b>2.940</b>	<b>4.132</b>	<b>4.363</b>	<b>4.674</b>	<b>5.046</b>
	Kg		94	110	110	123	123
<b>220 (270-320)x100</b> 85 (105-125)x39 inches	<b>SAIH16</b>	-	<b>3.035</b>	<b>4.233</b>	<b>4.493</b>	<b>4.785</b>	<b>5.162</b>
	Kg		98	120	120	130	130

## New up system Botte



<b>180 (230-280)x110</b> 70 (90-109)x43 inches	<b>SAIHB3</b>	<b>2.906</b>	-	<b>4.352</b>	<b>4.523</b>	<b>5.861 *</b>	<b>6.105</b>
	Kg	90		96	97	117	117
<b>200 (250-300)x110</b> 78 (95-118)x43 inches	<b>SAIHB4</b>	<b>2.948</b>	-	<b>4.475</b>	<b>4.738</b>	<b>5.933 *</b>	<b>6.206</b>
	Kg	94		112	112	123	123
<b>220 (270-320)x120</b> 85 (105-125)x47 inches	<b>SAIHB6</b>	<b>3.053</b>	-	<b>4.677</b>	<b>5.010</b>	<b>6.146 *</b>	<b>6.299</b>
	Kg	98		122	125	130	130

\* **Ceramica Elegance a botte solo su finitura Urban Marble 034 e Amani 035**

*Barrel-shaped Ceramica Elegance only available for Urban Marble 034 and Amani 035 finishes / Forme tonneau en Céramique Elegance uniquement dans les finitions Urban Marble 034 et Amani 035*

# Silver - Fisso

## Silver tavolo fisso

Silver fixed table

Silver table fixe

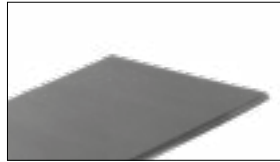

## Struttura in metallo verniciato

Coated metal frame / Structure en métal laqué

### Finiture struttura opaca di serie:

**Bianco Gesso - Antracite - Fango**

Standard matt frame finishes:  
Chalk White - Anthracite - Mud

Finitions mates standard de la structure :  
Blanc Craie - Anthracite - Boue

### Maggiorazione per colore struttura optional (patella di copertina)

Surcharge for optional frame colour  
(see colour chart on cover)

Supplément pour coloris structure  
optionnel (voir rabat en couverture)

€ 500

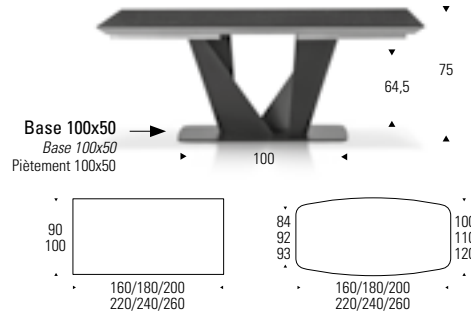

**Profilo piano ceramica**  
Ceramic top edge  
Chant plateau céramique



**Profilo piano materico bordo scaricato**  
Edge of textured top  
with bevelled edge  
Chant plateau texturé incliné



**Profilo altri piani**  
Edge for other tops  
Chant autres plateaux

	M <sup>3</sup>
160x90/100	0,75
180x100/110	0,80
200x100/110	0,85
220x100/120	0,90
240x100/120	1,10
260x100/120	1,23



		<b>Materico</b> Textured matt Texturé	<b>Materico bordo scaricato</b> Textured matt with sloping edge Texturé chant en pente	<b>Vetro trasparente e fumé</b> Clear and smoked glass Verre transparent et fumé	<b>Ceramica Elegance</b> Elegance Ceramic Céramique Elegance	<b>Ceramica Premium</b> Premium Ceramic Céramique Premium	<b>Basamento</b> Base Piètement
cod.							
Sp. Thk/Ép.		2 cm	3 cm	1,2 cm	1,4 cm	1,4 cm	

## Rettangolare

	<b>160x90</b> 63x36 inches	<b>SILF10</b>	-	<b>1.792</b>	<b>2.470</b>	<b>2.614</b>	<b>2.756</b>	<b>1.565</b>
		Kg		92	107	111	111	
	<b>180x100</b> 70x39 inches	<b>SILF12</b>	-	<b>1.852</b>	<b>2.485</b>	<b>2.783</b>	<b>3.071</b>	<b>1.565</b>
		Kg		99	118	123	123	
	<b>200x100</b> 78x39 inches	<b>SILF14</b>	-	<b>1.889</b>	<b>2.572</b>	<b>2.859</b>	<b>3.218</b>	<b>1.565</b>
		Kg		103	124	129	129	
	<b>220x100</b> 85x39 inches	<b>SILF16</b>	-	<b>2.062</b>	<b>2.705</b>	<b>2.957</b>	<b>3.352</b>	<b>1.565</b>
	Kg		107	130	136	136		
<b>240x100</b> 94x39 inches	<b>SILF18</b>	-	<b>2.099</b>	<b>2.775</b>	<b>3.192</b>	<b>3.644</b>	<b>1.565</b>	
	Kg		110	136	145	145		
<b>260x100</b> 101x39 inches	<b>SILF20</b>	-	<b>2.133</b>	<b>2.870</b>	<b>3.331</b>	<b>3.720</b>	<b>1.565</b>	
	Kg		114	142	149	149		

## Botte

	<b>160x100</b> 63x36 inches	<b>SILFB2</b>	<b>1.839</b>	-	<b>2.524</b>	<b>3.085</b>	<b>3.138</b>	<b>1.565</b>
		Kg	95		112	116	116	
	<b>180x110</b> 70x43 inches	<b>SILFB3</b>	<b>1.903</b>	-	<b>2.708</b>	<b>3.865 *</b>	<b>3.970</b>	<b>1.565</b>
		Kg	104		123	128	128	
	<b>200x110</b> 78x43 inches	<b>SILFB4</b>	<b>1.923</b>	-	<b>2.809</b>	<b>3.957 *</b>	<b>4.062</b>	<b>1.565</b>
		Kg	107		129	134	134	
	<b>220x120</b> 85x47 inches	<b>SILFB6</b>	<b>2.099</b>	-	<b>2.961</b>	<b>4.028 *</b>	<b>4.128</b>	<b>1.565</b>
	Kg	111		135	141	141		
<b>240x120</b> 94x47 inches	<b>SILFB7</b>	<b>2.125</b>	-	<b>3.066</b>	<b>4.296 *</b>	<b>4.406</b>	<b>1.565</b>	
	Kg	114		141	150	150		
<b>260x120</b> 101x47 inches	<b>SILFB8</b>	<b>2.170</b>	-	<b>3.140</b>	<b>4.425 *</b>	<b>4.525</b>	<b>1.565</b>	
	Kg	117		147	154	154		

\* **Ceramica Elegance a botte solo su finitura Urban Marble 034 e Amani 035**

Barrel-shaped Ceramica Elegance only available for Urban Marble 034 and Amani 035 finishes / Forme tonneau en Céramique Elegance uniquement dans les finitions Urban Marble 034 et Amani 035

# Silver - Allungabile One system

## One system staffe estraibili con allunghe esterne

One system mechanism with pull-out brackets and external extension leaves

One system bras extractibles avec allonges séparées

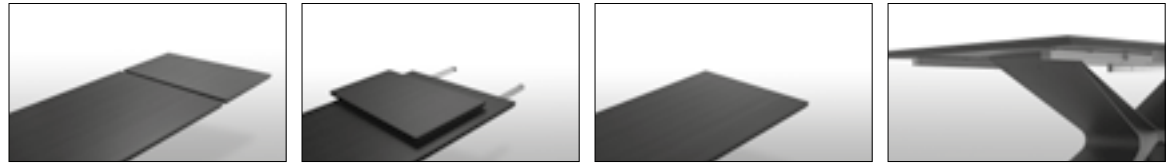

## Struttura in metallo verniciato

Coated metal frame / Structure en métal laqué

### Finiture struttura opaca di serie: Bianco Gesso - Antracite - Fango

Standard matt frame finishes: Chalk White - Anthracite - Mud

Finitions mates standard de la structure: Blanc Craie - Anthracite - Boue

### Maggiorazione per colore struttura optional (patella di copertina)

Surcharge for optional frame colour (see colour chart on cover)

Supplément pour coloris structure optionnel (voir rabat en couverture)

€ 500

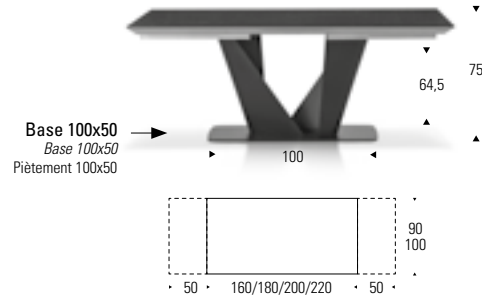

Profilo piano materico bordo scaricato

Edge of textured top with bevelled edge

Chant plateau texturé incliné

	M <sup>3</sup>
160x90	0,75
180x100	0,80
200x100	0,85
220x100	0,90



**Materico bordo scaricato**  
Textured matt with sloping edge  
Texturé chant en pente

cod.

Sp. Thk/Ép.

3 cm

## One system

	<b>160 (210-260)x90</b> 63 (83-102) x36 inches	<b>SIL010</b>	<b>2.281</b>				
		Kg	109				
	<b>180 (230-280)x100</b> 70 (90-109)x39 inches	<b>SIL012</b>	<b>2.349</b>				
		Kg	118				
	<b>200 (250-300)x100</b> 78 (95-118)x39 inches	<b>SIL014</b>	<b>2.387</b>				
		Kg	122				
	<b>220 (270-320)x100</b> 85 (105-125)x39 inches	<b>SIL016</b>	<b>2.439</b>				
		Kg	126				

# Silver - Allungabile New up system

## New up system

### binario scorrevole e alzabile

New up system mechanism with sliding, lift-up track

New up system rail coulissant et relevable

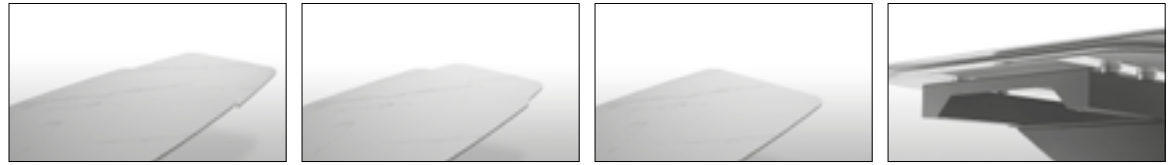

## Struttura in metallo verniciato

Coated metal frame / Structure en métal laqué

### Finiture struttura opaca di serie: Bianco Gesso - Antracite - Fango

Standard matt frame finishes: Chalk White - Anthracite - Mud

Finitions mates standard de la structure: Blanc Craie - Anthracite - Boue

### Maggiorazione per colore struttura optional (patella di copertina)

Surcharge for optional frame colour (see colour chart on cover)

Supplément pour coloris structure optionnel (voir rabat en couverture)

€ 500

### Maggiorazione su ceramica Premium con allunghe in Bilia

Surcharge for Premium ceramic top with extension leaves in a matching pattern

Supplément pour céramique Premium avec allonges même aspect que plateau

€ 400

### Allunghe ceramica Elegance non disponibile in Bilia

Elegance ceramic extension leaves not available in a matching pattern  
Allonges en céramique Elegance non disponibles avec même aspect que le plateau

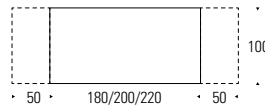
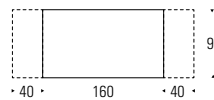
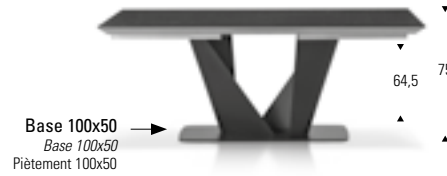

Profilo piano ceramica  
Ceramic top edge  
Chant plateau céramique



Profilo piano materico bordo scaricato  
Edge of textured top with bevelled edge  
Chant plateau texturé incliné



Profilo altri piani  
Edge for other tops  
Chant autres plateaux

Indicare nell'ordine il colore del meccanismo se diverso dall'abbinamento consigliato (vedi pag. 6)  
Please specify the colour of the mechanism if it differs from the recommended pairings (see page 6)  
Indiquer dans la commande le coloris du mécanisme s'il est différent de l'association conseillée (voir page 6)

	M <sup>3</sup>
160x90	0,75
180x100	0,85
200x100	1,14
220x100	1,24



	cod.	Materico bordo scaricato Textured matt with sloping edge Texturé chant en pente	Vetro trasparente e fumé Clear and smoked glass Verre transparent et fumé	Ceramica Elegance Elegance Ceramic Céramique Elegance	Ceramica Premium Premium Ceramic Céramique Premium	
Sp. Thk/Ép.		2 cm	1,2 cm	1,4 cm	1,4 cm	

## New up system

Diagram	Dimensions (cm)	Code	Weight (Kg)	Price 1	Price 2	Price 3	Price 4
	160 (200-240)x90 63 (78-94)x36 inches	SILH10	Kg	2.968	3.976	4.474	4.712
			109	133	127	127	
	180 (230-280)x100 70 (90-109)x39 inches	SILH12	Kg	3.014	4.145	4.641	4.928
			118	154	145	145	
	200 (250-300)x100 78 (95-118)x39 inches	SILH14	Kg	3.078	4.271	4.733	5.096
			122	160	152	152	
	220 (270-320)x100 85 (105-125)x39 inches	SILH16	Kg	3.174	4.372	4.842	5.209
			126	166	158	158	



# Space - Fisso

## Space tavolo fisso

Space fixed table

Space table fixe

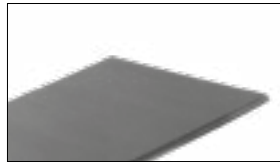

## Programma al centimetro

Made-to-measure range / Programme au centimètre

### Finiture struttura opaca di serie: Bianco Gesso - Antracite - Fango

Standard matt frame finishes:  
Chalk White - Anthracite - Mud

Finitions mates standard de la structure :  
Blanc Craie - Anthracite - Boue

### Maggiorazione per colore struttura optional (patella di copertina)

Surcharge for optional frame colour  
(see colour chart on cover)

Supplément pour coloris structure  
optionnel (voir rabat en couverture)

€ 350

Al telaio  
Floor to under-frame H  
H. sol-ceinture



Profilo piani  
Top edge  
Chant plateaux

70	75
100÷139 - 140÷160	161÷190 - 191÷210
211÷230 - 231÷250	251÷270

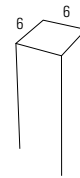

Sezione gamba  
Leg cross-section  
Section pied

	M <sup>3</sup>
100÷139	0,25
140÷160	0,26
161÷190	0,27
191÷210	0,28
211÷230	0,29
231÷250	0,30
251÷270	0,31
271÷290	0,32



Sp. Thk/Ép.	prof.	cod.	Materico Textured matt Texturé	Vetro colorato lucido Gloss lacquered glass Verre coloré brillant	Basamento fisso Fixed base Piètement fixe
			2 cm	0,8 cm	

## Rettangolare

<b>90÷139</b> 36÷55 inches	70 27 inches	<b>SPAFA70</b>	<b>857</b>	<b>1.165</b>		<b>735</b>
	75 29 inches	<b>SPAFA75</b>				
<b>140÷160</b> 55÷63 inches	70 27 inches	<b>SPAFB70</b>	<b>908</b>	<b>1.262</b>		<b>766</b>
	75 29 inches	<b>SPAFB75</b>				
<b>161÷190</b> 63÷74 inches	70 27 inches	<b>SP AFC70</b>	<b>979</b>	<b>1.401</b>		<b>811</b>
	75 29 inches	<b>SP AFC75</b>				
<b>191÷210</b> 75÷83 inches	70 27 inches	<b>SPAFD70</b>	<b>1.028</b>	<b>1.493</b>		<b>841</b>
	75 29 inches	<b>SPAFD75</b>				
<b>211÷230</b> 82÷91 inches	70 27 inches	<b>SPAFE70</b>	<b>1.075</b>	<b>1.586</b>		<b>872</b>
	75 29 inches	<b>SPAFE75</b>				
<b>231÷250</b> 91÷99 inches	70 27 inches	<b>SPAFF70</b>	<b>1.124</b>	<b>1.678</b>		<b>901</b>
	75 29 inches	<b>SPAFF75</b>				
<b>251÷270</b> 99÷106 inches	70 27 inches	<b>SPAFG70</b>	<b>1.172</b>	<b>1.770</b>		<b>932</b>
	75 29 inches	<b>SPAFG75</b>				

Tavolo Space al centimetro, è disponibile anche nella versione penisola senza maggiorazione di prezzo.

Made-to-measure Space table; also available in the peninsula version at no extra charge.

Table Space au centimètre, elle existe également pour agencement en épi sans supplément de prix.

# Space - Fisso

## Space tavolo fisso

Space fixed table

Space table fixe



## Programma al centimetro

Made-to-measure range / Programme au centimètre

### Finiture struttura opaca di serie: Bianco Gesso - Antracite - Fango

Standard matt frame finishes:  
Chalk White - Anthracite - Mud

Finitions mates standard de la structure :  
Blanc Craie - Anthracite - Boue

### Maggiorazione per colore struttura optional (patella di copertina)

Surcharge for optional frame colour  
(see colour chart on cover)

Supplément pour coloris structure  
optionnel (voir rabat en couverture)

€ 350

Al telaio  
Floor to under-frame H  
H. sol-ceinture



80	85
100÷139 - 140÷160	161÷190 - 191÷210
211÷230 - 231÷250	251÷270

Profilo piani  
Top edge  
Chant plateaux

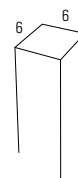

Sezione gamba  
Leg cross-section  
Section pied

	M <sup>3</sup>
100÷139	0,26
140÷160	0,27
161÷190	0,28
191÷210	0,29
211÷230	0,30
231÷250	0,31
251÷270	0,32
271÷290	0,33



Sp. Thk/Ép.	prof.	cod.	Materico Textured matt Texturé	Vetro colorato lucido Gloss lacquered glass Verre coloré brillant	Basamento fisso Fixed base Piètement fixe
			2 cm	0,8 cm	

## Rettangolare

<b>90÷139</b> 36÷55 inches	80 31 inches	<b>SPAFA80</b>	<b>888</b>	<b>1.238</b>		<b>751</b>
	85 33 inches	<b>SPAFA85</b>				
		Kg	32	40		20
<b>140÷160</b> 55÷63 inches	80 31 inches	<b>SPAFB80</b>	<b>942</b>	<b>1.344</b>		<b>780</b>
	85 33 inches	<b>SPAFB85</b>				
		Kg	37	47		20
<b>161÷190</b> 63÷74 inches	80 31 inches	<b>SPAFC80</b>	<b>1.017</b>	<b>1.494</b>		<b>827</b>
	85 33 inches	<b>SPAFC85</b>				
		Kg	42	53		20
<b>191÷210</b> 75÷83 inches	80 31 inches	<b>SPAFD80</b>	<b>1.067</b>	<b>1.595</b>		<b>856</b>
	85 33 inches	<b>SPAFD85</b>				
		Kg	45	57		20
<b>211÷230</b> 82÷91 inches	80 31 inches	<b>SPAFE80</b>	<b>1.118</b>	<b>1.696</b>		<b>887</b>
	85 33 inches	<b>SPAFE85</b>				
		Kg	48	62		20
<b>231÷250</b> 91÷99 inches	80 31 inches	<b>SPAFF80</b>	<b>1.169</b>	<b>1.797</b>		<b>917</b>
	85 33 inches	<b>SPAFF85</b>				
		Kg	51	66		20
<b>251÷270</b> 99÷106 inches	80 31 inches	<b>SPAFG80</b>	<b>1.218</b>	<b>1.897</b>		<b>948</b>
	85 33 inches	<b>SPAFG85</b>				
		Kg	54	70		20

Tavolo Space al centimetro, è disponibile anche nella versione penisola senza maggiorazione di prezzo.

Made-to-measure Space table; also available in the peninsula version at no extra charge.

Table Space au centimètre, elle existe également pour agencement en épi sans supplément de prix.

# Space - Fisso

## Space tavolo fisso

Space fixed table

Space table fixe

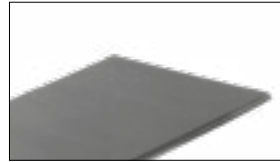

## Programma al centimetro

Made-to-measure range / Programme au centimètre

### Finiture struttura opaca di serie: Bianco Gesso - Antracite - Fango

Standard matt frame finishes:  
Chalk White - Anthracite - Mud

Finitions mates standard de la structure :  
Blanc Craie - Anthracite - Boue

### Maggiorazione per colore struttura optional (patella di copertina)

Surcharge for optional frame colour  
(see colour chart on cover)

Supplément pour coloris structure  
optionnel (voir rabat en couverture)

€ 350

Al telaio  
Floor to under-frame H  
H. sol-ceinture



90	95
100÷139	140÷160
161÷190	191÷210
211÷230	231÷250
251÷270	

Profilo piani  
Top edge  
Chant plateau

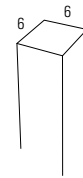

Sezione gamba  
Leg cross-section  
Section pied

	M <sup>3</sup>
100÷139	0,27
140÷160	0,28
161÷190	0,29
191÷210	0,30
211÷230	0,31
231÷250	0,32
251÷270	0,33
271÷290	0,34



Sp. Thk/Ép.	prof.	cod.	Materico Textured matt Texturé	Vetro colorato lucido Gloss lacquered glass Verre coloré brillant	Basamento fisso Fixed base Piètement fixe
			2 cm	0,8 cm	

## Rettangolare

<b>90÷139</b> 36÷55 inches	90 35 inches	<b>SPAFA90</b>	<b>920</b>	<b>1.311</b>		<b>766</b>
	95 37 inches	<b>SPAFA95</b>				
		Kg	34	43		20
<b>140÷160</b> 55÷63 inches	90 35 inches	<b>SPAFB90</b>	<b>975</b>	<b>1.425</b>		<b>796</b>
	95 37 inches	<b>SPAFB95</b>				
		Kg	40	50		20
<b>161÷190</b> 63÷74 inches	90 35 inches	<b>SPAFC90</b>	<b>1.054</b>	<b>1.588</b>		<b>841</b>
	95 37 inches	<b>SPAFC95</b>				
		Kg	45	57		20
<b>191÷210</b> 75÷83 inches	90 35 inches	<b>SPAFD90</b>	<b>1.107</b>	<b>1.697</b>		<b>872</b>
	95 37 inches	<b>SPAFD95</b>				
		Kg	48	62		20
<b>211÷230</b> 82÷91 inches	90 35 inches	<b>SPAFE90</b>	<b>1.160</b>	<b>1.806</b>		<b>901</b>
	95 37 inches	<b>SPAFE95</b>				
		Kg	51	67		20
<b>231÷250</b> 91÷99 inches	90 35 inches	<b>SPAFF90</b>	<b>1.213</b>	<b>1.916</b>		<b>932</b>
	95 37 inches	<b>SPAFF95</b>				
		Kg	55	72		20
<b>251÷270</b> 99÷106 inches	90 35 inches	<b>SPAFG90</b>	<b>1.265</b>	<b>2.024</b>		<b>962</b>
	95 37 inches	<b>SPAFG95</b>				
		Kg	58	76		20

Tavolo Space al centimetro, è disponibile anche nella versione penisola senza maggiorazione di prezzo.

Made-to-measure Space table; also available in the peninsula version at no extra charge.

Table Space au centimètre, elle existe également pour agencement en épi sans supplément de prix.

# Space - Fisso

## Space tavolo fisso

Space fixed table

Space table fixe

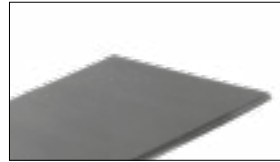

## Programma al centimetro

Made-to-measure range / Programme au centimètre

### Finiture struttura opaca di serie: Bianco Gesso - Antracite - Fango

Standard matt frame finishes:  
Chalk White - Anthracite - Mud

Finitions mates standard de la structure :  
Blanc Craie - Anthracite - Boue

### Maggiorazione per colore struttura optional (patella di copertina)

Surcharge for optional frame colour  
(see colour chart on cover)

Supplément pour coloris structure  
optionnel (voir rabat en couverture)

€ 350

Al telaio  
Floor to under-frame H  
H. sol-ceinture



100	110
100÷139 - 140÷160	
161÷190 - 191÷210	
211÷230 - 231÷250	
251÷270	

Profilo piani  
Top edge  
Chant plateau

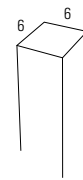

Sezione gamba  
Leg cross-section  
Section pied

	M <sup>3</sup>
100÷139	0,28
140÷160	0,29
161÷190	0,30
191÷210	0,31
211÷230	0,32
231÷250	0,33
251÷270	0,34
271÷290	0,35



Sp. Thk/Ép.	prof.	cod.	Materico Textured matt Texturé	Vetro colorato lucido Gloss lacquered glass Verre coloré brillant	Basamento fisso Fixed base Piètement fixe
			2 cm	0,8 cm	

## Rettangolare

<b>100÷139</b> 40÷55 inches	100 39 inches	SPAFA100	<b>967</b>	<b>1.419</b>		<b>788</b>
	110 43 inches	SPAFA110				
		Kg	38	48		20
<b>140÷160</b> 55÷63 inches	100 39 inches	SPAFB100	<b>1.027</b>	<b>1.547</b>		<b>819</b>
	110 43 inches	SPAFB110				
		Kg	43	56		20
<b>161÷190</b> 63÷74 inches	100 39 inches	SPAFC8100	<b>1.111</b>	<b>1.729</b>		<b>864</b>
	110 43 inches	SPAFC110				
		Kg	49	64		20
<b>191÷210</b> 75÷83 inches	100 39 inches	SPAFD100	<b>1.168</b>	<b>1.851</b>		<b>895</b>
	110 43 inches	SPAFD110				
		Kg	53	69		20
<b>211÷230</b> 82÷91 inches	100 39 inches	SPAFE100	<b>1.224</b>	<b>1.972</b>		<b>924</b>
	110 43 inches	SPAFE110				
		Kg	57	74		20
<b>231÷250</b> 91÷99 inches	100 39 inches	SPAFF100	<b>1.280</b>	<b>2.093</b>		<b>955</b>
	110 43 inches	SPAFF110				
		Kg	60	80		20
<b>251÷270</b> 99÷106 inches	100 39 inches	SPAFG100	<b>1.336</b>	<b>2.215</b>		<b>985</b>
	110 43 inches	SPAFG110				
		Kg	64	85		20

Tavolo Space al centimetro, è disponibile anche nella versione penisola senza maggiorazione di prezzo.

Made-to-measure Space table; also available in the peninsula version at no extra charge.

Table Space au centimètre, elle existe également pour agencement en épi sans supplément de prix.

# Space - Fisso

## Space tavolo fisso

Space fixed table

Space table fixe

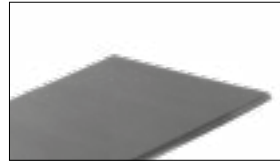

## Programma al centimetro

Made-to-measure range / Programme au centimètre

### Finiture struttura opaca di serie: Bianco Gesso - Antracite - Fango

Standard matt frame finishes:  
Chalk White - Anthracite - Mud

Finitions mates standard de la structure :  
Blanc Craie - Anthracite - Boue

### Maggiorazione per colore struttura optional (patella di copertina)

Surcharge for optional frame colour  
(see colour chart on cover)

Supplément pour coloris structure  
optionnel (voir rabat en couverture)

€ 350

Al telaio  
Floor to under-frame H  
H. sol-ceinture



▼

76

▲

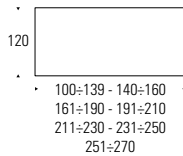

Profilo piani  
Top edge  
Chant plateau

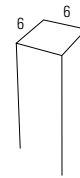

Sezione gamba  
Leg cross-section  
Section pied

	M <sup>3</sup>
100-139	0,29
140-160	0,30
161-190	0,31
191-210	0,32
211-230	0,33
231-250	0,34
251-270	0,35
271-290	0,36



Sp. Thk/Ép.	prof.	cod.	Materico Textured matt Texturé	Vetro colorato lucido Gloss lacquered glass Verre coloré brillant		Basamento fisso Fixed base Piètement fixe
			2 cm	0,8 cm		

## Rettangolare



<b>100-139</b> 40-55 inches	<b>120</b> 47 inches	<b>SPAFA120</b>	<b>999</b>	<b>1.492</b>		<b>803</b>
		Kg	40	51		20
<b>140-160</b> 55-63 inches	<b>120</b> 47 inches	<b>SPAFB120</b>	<b>1.061</b>	<b>1.628</b>		<b>833</b>
		Kg	46	59		20
<b>161-190</b> 63-74 inches	<b>120</b> 47 inches	<b>SPAFC120</b>	<b>1.149</b>	<b>1.801</b>		<b>879</b>
		Kg	52	68		20
<b>191-210</b> 75-83 inches	<b>120</b> 47 inches	<b>SPAFD120</b>	<b>1.207</b>	<b>1.955</b>		<b>909</b>
		Kg	56	74		20
<b>211-230</b> 82-91 inches	<b>120</b> 47 inches	<b>SPAFE120</b>	<b>1.265</b>	<b>2.082</b>		<b>940</b>
		Kg	60	79		20
<b>231-250</b> 91-99 inches	<b>120</b> 47 inches	<b>SPAFF120</b>	<b>1.325</b>	<b>2.211</b>		<b>970</b>
		Kg	64	85		20
<b>251-270</b> 99-106 inches	<b>120</b> 47 inches	<b>SPAFG120</b>	<b>1.383</b>	<b>2.341</b>		<b>1.000</b>
		Kg	68	91		20

Tavolo Space al centimetro, è disponibile anche nella versione penisola senza maggiorazione di prezzo.

Made-to-measure Space table; also available in the peninsula version at no extra charge.

Table Space au centimètre, elle existe également pour agencement en épi sans supplément de prix.

# Space quadrato - Fisso

## Space tavolo fisso

Space fixed table

Space table fixe

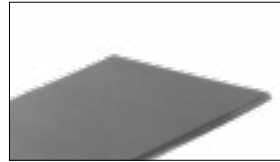

## Programma al centimetro

Made-to-measure range / Programme au centimètre

### Finiture struttura opaca di serie: Bianco Gesso - Antracite - Fango

Standard matt frame finishes:  
Chalk White - Anthracite - Mud

Finitions mates standard de la structure :  
Blanc Craie - Anthracite - Boue

### Maggiorazione per colore struttura optional (patella di copertina)

Surcharge for optional frame colour  
(see colour chart on cover)

Supplément pour coloris structure  
optionnel (voir rabat en couverture)

€ 350



Al telaio  
Floor to under-frame H  
H. sol-ceinture

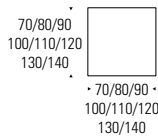

70/80/90  
100/110/120  
130/140



Profilo piani  
Top edge  
Chant plateaux

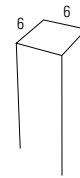

Sezione gamba  
Leg cross-section  
Section pied

	M <sup>3</sup>
70x70	0,25
80x80	0,27
90x90	0,29
100x100	0,31
110x110	0,33
120x120	0,35
130x130	0,37
140x140	0,39



Sp. Thk/Ép.	prof.	cod.	Materico Textured matt Texturé	Vetro colorato lucido Gloss lacquered glass Verre coloré brillant	Basamento fisso Fixed base Piètement fixe
			2 cm	0,8 cm	

## Quadrato

<b>70</b> 27 inches	<b>70</b> 27 inches	<b>SPAF070070</b>	<b>803</b>	<b>1.089</b>		<b>735</b>
		Kg	30	38		20
<b>80</b> 31 inches	<b>80</b> 31 inches	<b>SPAF080080</b>	<b>858</b>	<b>1.194</b>		<b>735</b>
		Kg	33	41		20
<b>90</b> 35 inches	<b>90</b> 35 inches	<b>SPAF090090</b>	<b>920</b>	<b>1.311</b>		<b>766</b>
		Kg	36	44		20
<b>100</b> 39 inches	<b>100</b> 39 inches	<b>SPAF100100</b>	<b>967</b>	<b>1.419</b>		<b>788</b>
		Kg	39	47		20
<b>110</b> 43 inches	<b>100</b> 39 inches	<b>SPAF110110</b>	<b>967</b>	<b>1.419</b>		<b>788</b>
		Kg	42	51		20
<b>120</b> 47 inches	<b>120</b> 47 inches	<b>SPAF120120</b>	<b>999</b>	<b>1.492</b>		<b>803</b>
		Kg	45	54		20
<b>130</b> 51 inches	<b>130</b> 51 inches	<b>SPAF130130</b>	<b>1.032</b>	<b>1.582</b>		<b>834</b>
		Kg	48	57		20
<b>140</b> 55 inches	<b>140</b> 55 inches	<b>SPAF140140</b>	<b>1.066</b>	<b>1.671</b>		<b>864</b>
		Kg	51	60		20

# Space - Allungabile Cross system

## Cross system apertura telescopica della struttura

Cross system opening mechanism with telescopic frame

Cross system ouverture télescopique de la structure

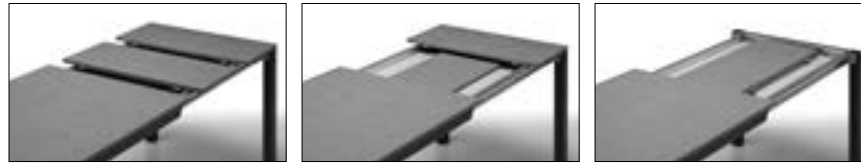

## Programma al centimetro

Made-to-measure range / Programme au centimètre

### Finiture struttura opaca di serie: Bianco Gesso - Antracite - Fango

Standard matt frame finishes: Chalk White - Anthracite - Mud

Finitions mates standard de la structure: Blanc Craie - Anthracite - Boue

### Maggiorazione per colore struttura optional (patella di copertina)

Surcharge for optional frame colour (see colour chart on cover)

Supplément pour coloris structure optionnel (voir rabat en couverture)

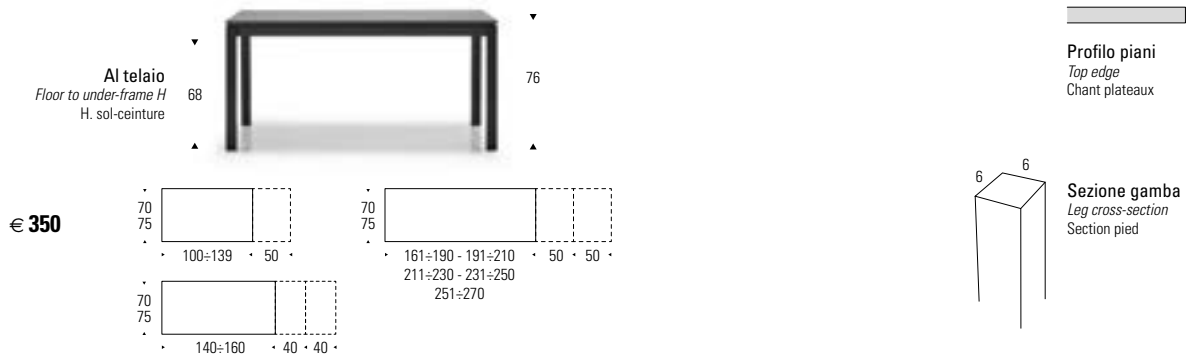

	M <sup>3</sup>
100-139	0,25
140-160	0,26
161-190	0,27
191-210	0,28
211-230	0,29
231-250	0,30
251-270	0,31
271-290	0,32



prof.	cod.	Materico Textured matt Texturé	Vetro colorato lucido Gloss lacquered glass Verre coloré brillant	Basamento allungabile Extending base Piètement extensible
Sp. 7hk/Ép.		2 cm	0,8 cm	

## Cross system

	<b>100-139 (1x50)</b> 40-55 (1x20) inches	70 27 inches 75 29 inches	<b>SPACA70</b> <b>SPACA75</b>	<b>1.514</b>	<b>1.823</b>	<b>1.393</b>
			Kg	38	45	20
	<b>140-160 (2x40)</b> 55-63 (2x16) inches	70 27 inches 75 29 inches	<b>SPACB70</b> <b>SPACB75</b>	<b>1.565</b>	<b>1.920</b>	<b>1.423</b>
			Kg	43	52	20
	<b>161-190 (2x50)</b> 63-74 (2x20) inches	70 27 inches 75 29 inches	<b>SPACC70</b> <b>SPACC75</b>	<b>1.637</b>	<b>2.059</b>	<b>1.469</b>
			Kg	49	59	20
	<b>191-210 (2x50)</b> 75-83 (2x20) inches	70 27 inches 75 29 inches	<b>SPACD70</b> <b>SPACD75</b>	<b>1.685</b>	<b>2.151</b>	<b>1.499</b>
			Kg	52	63	20
	<b>211-230 (2x50)</b> 82-91 (2x20) inches	70 27 inches 75 29 inches	<b>SPACE70</b> <b>SPACE75</b>	<b>1.733</b>	<b>2.243</b>	<b>1.529</b>
			Kg	56	68	20
	<b>231-250 (2x50)</b> 91-99 (2x20) inches	70 27 inches 75 29 inches	<b>SPACF70</b> <b>SPACF75</b>	<b>1.781</b>	<b>2.336</b>	<b>1.559</b>
			Kg	80	73	20
	<b>251-270 (2x50)</b> 99-106 (2x20) inches	70 27 inches 75 29 inches	<b>SPACG70</b> <b>SPACG75</b>	<b>1.829</b>	<b>2.428</b>	<b>1.590</b>
			Kg	63	78	20

Con piano in materico allunghe in tinta. Sulle altre versioni, allunghe in nobilitato bianco su finiture chiare e antracite su finiture scure. Misure inferiori a 100x125 e quadrato allunghe riposte a parte. Tavolo Space al centimetro, è disponibile anche nella versione penisola senza maggiorazione di prezzo.

Textured tops come with matching-coloured extension leaves. For other top versions, white melamine leaves are provided with pale-coloured tops while dark-coloured tops come with anthracite leaves. For tops smaller than 100x125 and for square tops the extension leaves are stored separately. Made-to-measure Space table; also available in the peninsula version at no extra charge.

En cas de plateau texturé, allonges dans la même teinte. Pour les autres versions, allonges en mélaminé blanc pour les finitions claires et anthracite pour les finitions foncées. Pour table inférieure à 100x125 et carrée, allonges séparées. Table Space au centimètre, elle existe également pour agencement en épi sans supplément de prix.

# Space - Allungabile Cross system

## Cross system apertura telescopica della struttura

Cross system opening mechanism with telescopic frame

Cross system ouverture télescopique de la structure

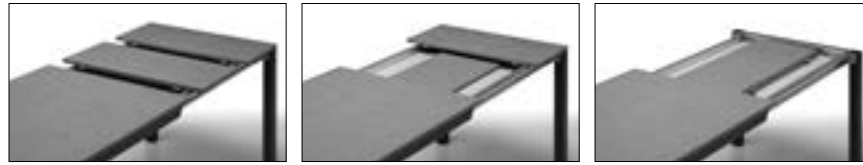

## Programma al centimetro

Made-to-measure range / Programme au centimètre

### Finiture struttura opaca di serie: Bianco Gesso - Antracite - Fango

Standard matt frame finishes: Chalk White - Anthracite - Mud

Finitions mates standard de la structure: Blanc Craie - Anthracite - Boue

### Maggiorazione per colore struttura optional (patella di copertina)

Surcharge for optional frame colour (see colour chart on cover)

Supplément pour coloris structure optionnel (voir rabat en couverture)

€ 350

Al telaio  
Floor to under-frame H  
H. sol-ceinture

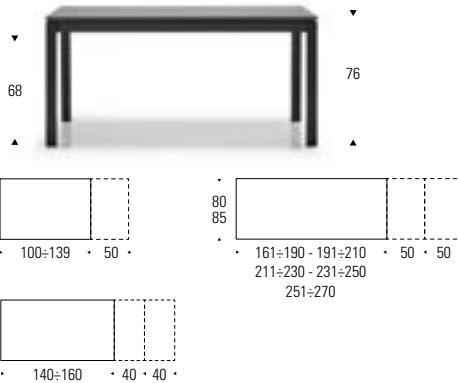

Profilo piani  
Top edge  
Chant plateaux

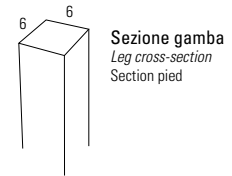







Sezione gamba  
Leg cross-section  
Section pied

	M <sup>3</sup>
100÷139	0,26
140÷160	0,27
161÷190	0,28
191÷210	0,29
211÷230	0,30
231÷250	0,31
251÷270	0,32
271÷290	0,33

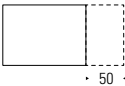
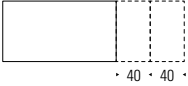

Sp. Thk/Ép.	prof.	cod.	Materico Textured matt Texturé	Vetro colorato lucido Gloss lacquered glass Verre coloré brillant	Basamento allungabile Extending base Piètement extensible
			2 cm	0,8 cm	

## Cross system

	<b>100÷139 (1x50)</b> 40÷55 (1x20) inches	<b>80</b> 31 inches <b>85</b> 33 inches	<b>SPACA80</b> <b>SPACA85</b>	<b>1.546</b> Kg 40	<b>1.896</b> 48	<b>1.407</b> 22
		<b>140÷160 (2x40)</b> 55÷63 (2x16) inches	<b>80</b> 31 inches <b>85</b> 33 inches	<b>SPACB80</b> <b>SPACB85</b>	<b>1.599</b> Kg 46	<b>2.001</b> 56
		<b>161÷190 (2x50)</b> 63÷74 (2x20) inches	<b>80</b> 31 inches <b>85</b> 33 inches	<b>SPACC80</b> <b>SPACC85</b>	<b>1.675</b> Kg 52	<b>2.152</b> 63
		<b>191÷210 (2x50)</b> 75÷83 (2x20) inches	<b>80</b> 31 inches <b>85</b> 33 inches	<b>SPACD80</b> <b>SPACD85</b>	<b>1.725</b> Kg 56	<b>2.252</b> 69
		<b>211÷230 (2x50)</b> 82÷91 (2x20) inches	<b>80</b> 31 inches <b>85</b> 33 inches	<b>SPACE80</b> <b>SPACE85</b>	<b>1.775</b> Kg 60	<b>2.353</b> 74
		<b>231÷250 (2x50)</b> 91÷99 (2x20) inches	<b>80</b> 31 inches <b>85</b> 33 inches	<b>SPACF80</b> <b>SPACF85</b>	<b>1.825</b> Kg 64	<b>2.453</b> 79
		<b>251÷270 (2x50)</b> 99÷106 (2x20) inches	<b>80</b> 31 inches <b>85</b> 33 inches	<b>SPACG80</b> <b>SPACG85</b>	<b>1.876</b> Kg 68	<b>2.555</b> 84

Con piano in materico allunghe in tinta. Sulle altre versioni, allunghe in nobilitato bianco su finiture chiare e antracite su finiture scure. Misure inferiori a 100x125 e quadrato allunghe riposte a parte. Tavolo Space al centimetro, è disponibile anche nella versione penisola senza maggiorazione di prezzo.

Textured tops come with matching-coloured extension leaves. For other top versions, white melamine leaves are provided with pale-coloured tops while dark-coloured tops come with anthracite leaves. For tops smaller than 100x125 and for square tops the extension leaves are stored separately. Made-to-measure Space table; also available in the peninsula version at no extra charge.

En cas de plateau texturé, allonges dans la même teinte. Pour les autres versions, allonges en mélaminé blanc pour les finitions claires et anthracite pour les finitions foncées. Pour table inférieure à 100x125 et carrée, allonges séparées. Table Space au centimètre, elle existe également pour agencement en épi sans supplément de prix.



# Space - Allungabile Cross system

## Cross system apertura telescopica della struttura

Cross system opening mechanism with telescopic frame

Cross system ouverture télescopique de la structure

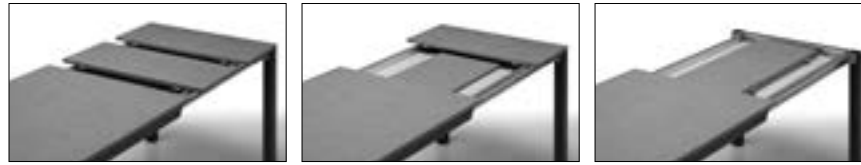

## Programma al centimetro

Made-to-measure range / Programme au centimètre

### Finiture struttura opaca di serie: Bianco Gesso - Antracite - Fango

Standard matt frame finishes: Chalk White - Anthracite - Mud

Finitions mates standard de la structure: Blanc Craie - Anthracite - Boue

### Maggiorazione per colore struttura optional (patella di copertina)

Surcharge for optional frame colour (see colour chart on cover)

Supplément pour coloris structure optionnel (voir rabat en couverture)

€ 350

Al telaio  
Floor to under-frame H  
H. sol-ceinture

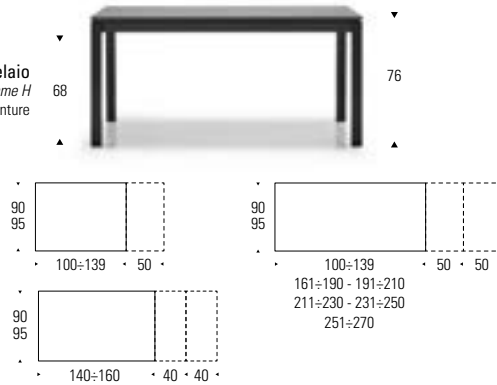

Profilo piani  
Top edge  
Chant plateaux

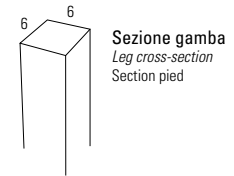

Sezione gamba  
Leg cross-section  
Section pied

	M <sup>3</sup>
100-139	0,27
140-160	0,28
161-190	0,29
191-210	0,30
211-230	0,31
231-250	0,32
251-270	0,33
271-290	0,34



Sp. Thk/Ép.	prof.	cod.	Materico Textured matt Texturé	Vetro colorato lucido Gloss lacquered glass Verre coloré brillant	Basamento allungabile Extending base Piètement extensible
			2 cm	0,8 cm	

## Cross system

	<b>100-139 (1x50)</b> 40-55 (1x20) inches	90 35 inches	<b>SPACA90</b>	<b>1.578</b>	<b>1.968</b>		<b>1.423</b>
		95 37 inches	<b>SPACA95</b>				
	<b>140-160 (2x40)</b> 55-63 (2x16) inches	90 35 inches	<b>SPACB90</b>	<b>1.633</b>	<b>2.083</b>		<b>1.454</b>
		95 37 inches	<b>SPACB95</b>				
	<b>161-190 (2x50)</b> 63-74 (2x20) inches	90 35 inches	<b>SPACC90</b>	<b>1.712</b>	<b>2.246</b>		<b>1.499</b>
		95 37 inches	<b>SPACC95</b>				
	<b>191-210 (2x50)</b> 75-83 (2x20) inches	90 35 inches	<b>SPACD90</b>	<b>1.765</b>	<b>2.354</b>		<b>1.529</b>
		95 37 inches	<b>SPACD95</b>				
	<b>211-230 (2x50)</b> 82-91 (2x20) inches	90 35 inches	<b>SPACE90</b>	<b>1.818</b>	<b>2.463</b>		<b>1.559</b>
		95 37 inches	<b>SPACE95</b>				
	<b>231-250 (2x50)</b> 91-99 (2x20) inches	90 35 inches	<b>SPACF90</b>	<b>1.870</b>	<b>2.572</b>		<b>1.590</b>
		95 37 inches	<b>SPACF95</b>				
	<b>251-270 (2x50)</b> 99-106 (2x20) inches	90 35 inches	<b>SPACG90</b>	<b>1.923</b>	<b>2.681</b>		<b>1.620</b>
		95 37 inches	<b>SPACG95</b>				

Con piano in materico allunghe in tinta. Sulle altre versioni, allunghe in nobilitato bianco su finiture chiare e antracite su finiture scure. Misure inferiori a 100x125 e quadrato allunghe riposte a parte. Tavolo Space al centimetro, è disponibile anche nella versione penisola senza maggiorazione di prezzo.

Textured tops come with matching-coloured extension leaves. For other top versions, white melamine leaves are provided with pale-coloured tops while dark-coloured tops come with anthracite leaves. For tops smaller than 100x125 and for square tops the extension leaves are stored separately. Made-to-measure Space table; also available in the peninsula version at no extra charge.

En cas de plateau texturé, allonges dans la même teinte. Pour les autres versions, allonges en mélaminé blanc pour les finitions claires et anthracite pour les finitions foncées. Pour table inférieure à 100x125 et carrée, allonges séparées. Table Space au centimètre, elle existe également pour agencement en épi sans supplément de prix.

# Space - Allungabile Cross system

## Cross system apertura telescopica della struttura

Cross system opening mechanism with telescopic frame

Cross system ouverture télescopique de la structure

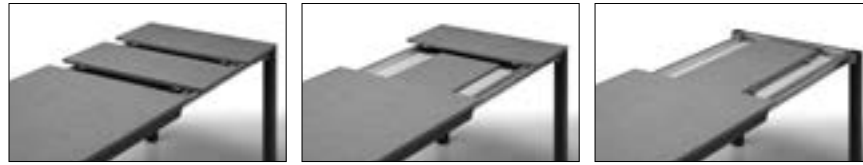

## Programma al centimetro

Made-to-measure range / Programme au centimètre

### Finiture struttura opaca di serie: Bianco Gesso - Antracite - Fango

Standard matt frame finishes: Chalk White - Anthracite - Mud

Finitions mates standard de la structure: Blanc Craie - Anthracite - Boue

### Maggiorazione per colore struttura optional (patella di copertina)

Surcharge for optional frame colour (see colour chart on cover)

Supplément pour coloris structure optionnel (voir rabat en couverture)

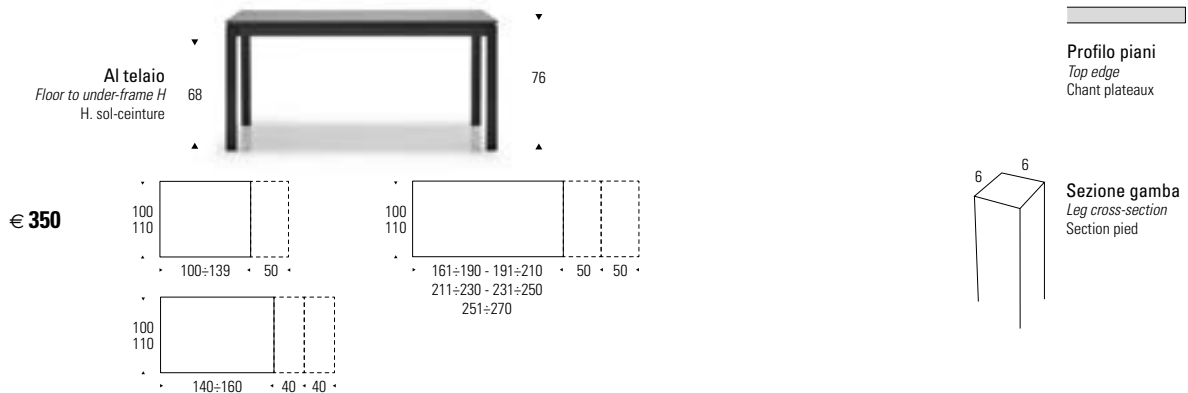

€ 350

	M <sup>3</sup>
100-139	0,28
140-160	0,29
161-190	0,30
191-210	0,31
211-230	0,32
231-250	0,33
251-270	0,34
271-290	0,35



Sp. Thk/Ép.	prof.	cod.	Materico Textured matt Texturé	Vetro colorato lucido Gloss lacquered glass Verre coloré brillant	Basamento allungabile Extending base Piètement extensible
			2 cm	0,8 cm	

## Cross system

	<b>100-139 (1x50)</b> 40-55 (1x20) inches	<b>100</b> 39 inches <b>110</b> 43 inches	<b>SPACA100</b> <b>SPACA110</b>	<b>1.625</b>	<b>2.077</b>	<b>1.446</b>
			Kg	47	57	29
	<b>140-160 (2x40)</b> 55-63 (2x16) inches	<b>100</b> 39 inches <b>110</b> 43 inches	<b>SPACB100</b> <b>SPACB110</b>	<b>1.685</b>	<b>2.205</b>	<b>1.476</b>
			Kg	54	66	29
	<b>161-190 (2x50)</b> 63-74 (2x20) inches	<b>100</b> 39 inches <b>110</b> 43 inches	<b>SPACC100</b> <b>SPACC110</b>	<b>1.768</b>	<b>2.386</b>	<b>1.522</b>
			Kg	60	75	29
	<b>191-210 (2x50)</b> 75-83 (2x20) inches	<b>100</b> 39 inches <b>110</b> 43 inches	<b>SPACD100</b> <b>SPACD110</b>	<b>1.825</b>	<b>2.507</b>	<b>1.551</b>
			Kg	65	81	29
	<b>211-230 (2x50)</b> 82-91 (2x20) inches	<b>100</b> 39 inches <b>110</b> 43 inches	<b>SPACE100</b> <b>SPACE110</b>	<b>1.881</b>	<b>2.629</b>	<b>1.582</b>
			Kg	69	87	29
	<b>231-250 (2x50)</b> 91-99 (2x20) inches	<b>100</b> 39 inches <b>110</b> 43 inches	<b>SPACF100</b> <b>SPACF110</b>	<b>1.938</b>	<b>2.750</b>	<b>1.612</b>
			Kg	74	93	29
	<b>251-270 (2x50)</b> 99-106 (2x20) inches	<b>100</b> 39 inches <b>110</b> 43 inches	<b>SPACG100</b> <b>SPACG110</b>	<b>1.994</b>	<b>2.871</b>	<b>1.643</b>
			Kg	79	99	29

Con piano in materico allunghe in tinta. Sulle altre versioni, allunghe in nobilitato bianco su finiture chiare e antracite su finiture scure. Misure inferiori a 100x125 e quadrato allunghe riposte a parte. Tavolo Space al centimetro, è disponibile anche nella versione penisola senza maggiorazione di prezzo.

Textured tops come with matching-coloured extension leaves. For other top versions, white melamine leaves are provided with pale-coloured tops while dark-coloured tops come with anthracite leaves. For tops smaller than 100x125 and for square tops the extension leaves are stored separately. Made-to-measure Space table; also available in the peninsula version at no extra charge.

En cas de plateau texturé, allonges dans la même teinte. Pour les autres versions, allonges en mélaminé blanc pour les finitions claires et anthracite pour les finitions foncées. Pour table inférieure à 100x125 et carrée, allonges séparées. Table Space au centimètre, elle existe également pour agencement en épi sans supplément de prix.

# Space - Allungabile Cross system

## Cross system apertura telescopica della struttura

Cross system opening mechanism with telescopic frame

Cross system ouverture télescopique de la structure

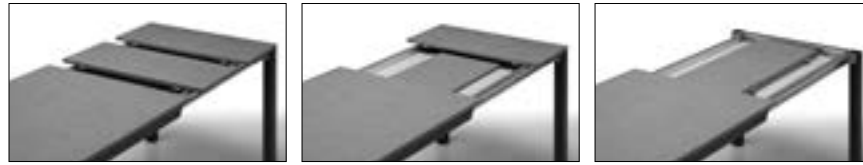

## Programma al centimetro

Made-to-measure range / Programme au centimètre

### Finiture struttura opaca di serie: Bianco Gesso - Antracite - Fango

Standard matt frame finishes: Chalk White - Anthracite - Mud

Finitions mates standard de la structure: Blanc Craie - Anthracite - Boue

### Maggiorazione per colore struttura optional (patella di copertina)

Surcharge for optional frame colour (see colour chart on cover)

Supplément pour coloris structure optionnel (voir rabat en couverture)

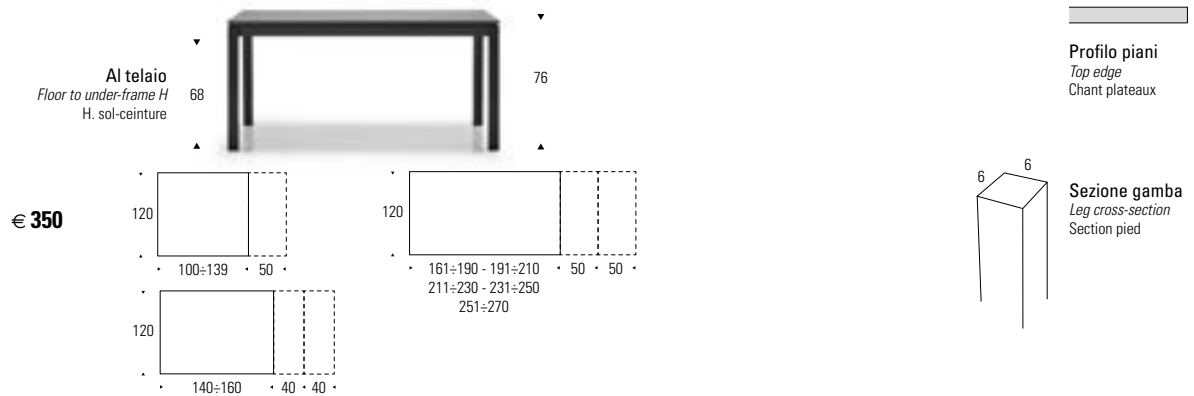

€ 350

	M <sup>3</sup>
100-139	0,29
140-160	0,30
161-190	0,31
191-210	0,32
211-230	0,33
231-250	0,34
251-270	0,35
271-290	0,36



prof.	cod.	Materico Textured matt Texturé	Vetro colorato lucido Gloss lacquered glass Verre coloré brillant	Basamento allungabile Extending base Piètement extensible
Sp. Thk/Ép.		2 cm	0,8 cm	

## Cross system

	<b>100-139 (1x50)</b> 40-55 (1x20) inches	120 47 inches	<b>SPACA120</b>	<b>1.657</b>	<b>2.150</b>	<b>1.461</b>
			Kg	49	60	31
	<b>140-160 (2x40)</b> 55-63 (2x16) inches	120 47 inches	<b>SPACB120</b>	<b>1.719</b>	<b>2.286</b>	<b>1.491</b>
			Kg	56	70	31
	<b>161-190 (2x50)</b> 63-74 (2x20) inches	120 47 inches	<b>SPACC120</b>	<b>1.807</b>	<b>2.480</b>	<b>1.536</b>
			Kg	64	80	31
	<b>191-210 (2x50)</b> 75-83 (2x20) inches	120 47 inches	<b>SPACD120</b>	<b>1.865</b>	<b>2.610</b>	<b>1.567</b>
			Kg	69	86	31
	<b>211-230 (2x50)</b> 82-91 (2x20) inches	120 47 inches	<b>SPACE120</b>	<b>1.923</b>	<b>2.739</b>	<b>1.597</b>
			Kg	73	93	31
	<b>231-250 (2x50)</b> 91-99 (2x20) inches	120 47 inches	<b>SPACF120</b>	<b>1.983</b>	<b>2.869</b>	<b>1.627</b>
			Kg	78	99	31
	<b>251-270 (2x50)</b> 99-106 (2x20) inches	120 47 inches	<b>SPACG120</b>	<b>2.041</b>	<b>2.999</b>	<b>1.658</b>
			Kg	83	106	31

Con piano in materico allunghe in tinta. Sulle altre versioni, allunghe in nobilitato bianco su finiture chiare e antracite su finiture scure. Misure inferiori a 100x125 e quadrato allunghe riposte a parte. Tavolo Space al centimetro, è disponibile anche nella versione penisola senza maggiorazione di prezzo.

Textured tops come with matching-coloured extension leaves. For other top versions, white melamine leaves are provided with pale-coloured tops while dark-coloured tops come with anthracite leaves. For tops smaller than 100x125 and for square tops the extension leaves are stored separately. Made-to-measure Space table; also available in the peninsula version at no extra charge.

En cas de plateau texturé, allonges dans la même teinte. Pour les autres versions, allonges en mélaminé blanc pour les finitions claires et anthracite pour les finitions foncées. Pour table inférieure à 100x125 et carrée, allonges séparées. Table Space au centimètre, elle existe également pour agencement en épi sans supplément de prix.

# Strong - Fisso

## Strong tavolo fisso

Strong fixed table

Strong table fixe

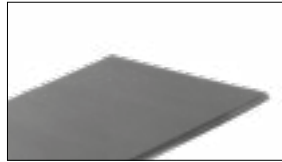

## Struttura in metallo verniciato

Coated metal frame / Structure en métal laqué

### Finiture struttura opaca di serie: Bianco Gesso - Antracite - Fango

Standard matt frame finishes:  
Chalk White - Anthracite - Mud

Finitions mates standard de la structure :  
Blanc Craie - Anthracite - Boue



▼  
75  
▲

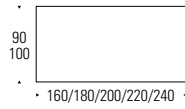

Profilo piani  
Top edge  
Profil plateau



Sezione piano  
Top cross-section  
Section plateau

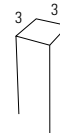

Sezione gamba  
Leg cross-section  
Section pied

	M <sup>3</sup>
160x90	0,20
180x100	0,21
200x100	0,22
220x100	0,24
240x100	0,26



**Materico**  
Textured matt  
Texturé

cod.

Sp. Thk/Ép.

2 cm

## Rettangolare

	<b>160x90</b> 63x36 inches	<b>STRF10</b>	<b>1.108</b>				
		Kg	54				
	<b>180x100</b> 70x39 inches	<b>STRF12</b>	<b>1.206</b>				
		Kg	56				
	<b>200x100</b> 78x39 inches	<b>STRF14</b>	<b>1.290</b>				
	Kg	59					
<b>220x100</b> 85x39 inches	<b>STRF16</b>	<b>1.340</b>					
	Kg	64					
<b>240x100</b> 93x39 inches	<b>STRF18</b>	<b>1.402</b>					
	Kg	68					

# Tiffany - Fisso

## Tiffany tavolo fisso

Tiffany fixed table

Tiffany table fixe

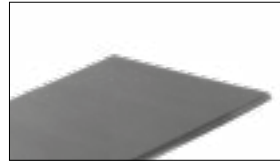

## Struttura in metallo verniciato

Coated metal frame / Structure en métal laqué

### Finiture struttura opaca di serie: Bianco Gesso - Antracite - Fango

Standard matt frame finishes:  
Chalk White - Anthracite - Mud

Finitions mates standard de la structure :  
Blanc Craie - Anthracite - Boue

### Maggiorazione per colore struttura optional (patella di copertina)

Surcharge for optional frame colour  
(see colour chart on cover)

Supplément pour coloris structure  
optionnel (voir rabat en couverture)

€ 350

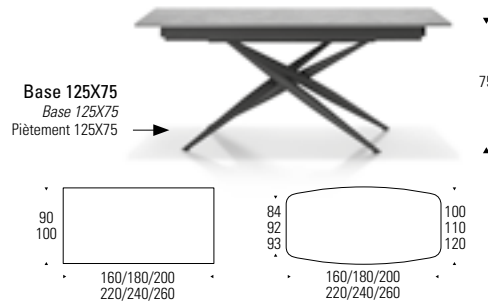

Profilo piano ceramica  
Ceramic top edge  
Chant plateau céramique

Profilo altri piani  
Edge for other tops  
Chant autres plateaux

Profilo piano materico  
bordo scaricato  
Edge of textured top  
with bevelled edge  
Chant plateau texturé incliné

	M <sup>3</sup>
160x90/100	0,90
180x100/110	1,00
200x100/110	1,10
220x100/120	1,20
240x100/120	1,30
260x100/120	1,40



		Materico Textured matt Texturé	Materico bordo scaricato Textured matt with sloping edge Texturé chant en pente	Vetro trasparente e fumé Clear and smoked glass Verre transparent et fumé	Glass decor	Ceramica Elegance Elegance Ceramic Céramique Elegance	Ceramica Premium Premium Ceramic Céramique Premium	Basamento Base Piètement
	cod.							
	Sp. Thk/Ép.	2 cm	2 cm	1,2 cm	1,2 cm	1,4 cm	1,4 cm	

## Rettangolare

<b>160x90</b> 63x36 inches	<b>TIFF10</b>	-	<b>1.098</b>	<b>1.835</b>	<b>1.872</b>	<b>1.988</b>	<b>2.356</b>	<b>935</b>
	Kg		64	80	80	83	83	46
<b>180x100</b> 70x39 inches	<b>TIFF12</b>	-	<b>1.172</b>	<b>1.949</b>	<b>1.969</b>	<b>2.165</b>	<b>2.403</b>	<b>935</b>
	Kg		71	90	90	95	95	46
<b>200x100</b> 78x39 inches	<b>TIFF14</b>	-	<b>1.212</b>	<b>2.008</b>	<b>2.045</b>	<b>2.276</b>	<b>2.538</b>	<b>935</b>
	Kg		75	96	96	101	101	46
<b>220x100</b> 85x39 inches	<b>TIFF16</b>	-	<b>1.379</b>	<b>2.141</b>	<b>2.189</b>	<b>2.413</b>	<b>2.698</b>	<b>935</b>
	Kg		78	102	102	108	108	46
<b>240x100</b> 94x39 inches	<b>TIFF18</b>	-	<b>1.418</b>	<b>2.202</b>	<b>2.288</b>	<b>2.714</b>	<b>2.981</b>	<b>935</b>
	Kg		82	108	108	114	114	46
<b>260x100</b> 101x39 inches	<b>TIFF20</b>	-	<b>1.454</b>	<b>2.320</b>	<b>2.411</b>	<b>2.858</b>	<b>3.010</b>	<b>935</b>
	Kg		86	114	114	120	120	46

## Botte

<b>160x100</b> 63x43 inches	<b>TIFFB2</b>	<b>1.153</b>	-	<b>1.811</b>	<b>1.993</b>	<b>2.345</b>	<b>2.397</b>	<b>935</b>
	Kg	64		80	80	83	83	46
<b>180x110</b> 70x43 inches	<b>TIFFB3</b>	<b>1.215</b>	-	<b>1.989</b>	<b>2.198</b>	<b>3.124 *</b>	<b>3.230</b>	<b>935</b>
	Kg	71		90	90	95	95	46
<b>200x110</b> 78x43 inches	<b>TIFFB4</b>	<b>1.235</b>	-	<b>2.096</b>	<b>2.378</b>	<b>3.217 *</b>	<b>3.321</b>	<b>935</b>
	Kg	75		96	96	101	101	46
<b>220x120</b> 85x47 inches	<b>TIFFB6</b>	<b>1.403</b>	-	<b>2.229</b>	<b>2.552</b>	<b>3.287 *</b>	<b>3.387</b>	<b>935</b>
	Kg	78		102	102	108	108	46
<b>240x120</b> 94x47 inches	<b>TIFFB7</b>	<b>1.427</b>	-	<b>2.337</b>	<b>2.703</b>	<b>3.556 *</b>	<b>3.666</b>	<b>935</b>
	Kg	82		108	108	114	114	46
<b>260x120</b> 101x47 inches	<b>TIFFB8</b>	<b>1.456</b>	-	<b>2.486</b>	<b>2.791</b>	<b>3.684 *</b>	<b>3.784</b>	<b>935</b>
	Kg	86		114	114	120	120	46

### \* Ceramica Elegance a botte solo su finitura Urban Marble 034 e Amani 035

Barrel-shaped Ceramica Elegance only available for Urban Marble 034 and Amani 035 finishes / Forme tonneau en Céramique Elegance uniquement dans les finitions Urban Marble 034 et Amani 035

# Tiffany - Allungabile One system

## One system staffe estraibili con allunghe esterne

One system mechanism with pull-out brackets and external extension leaves

One system bras extractibles avec allonges séparées

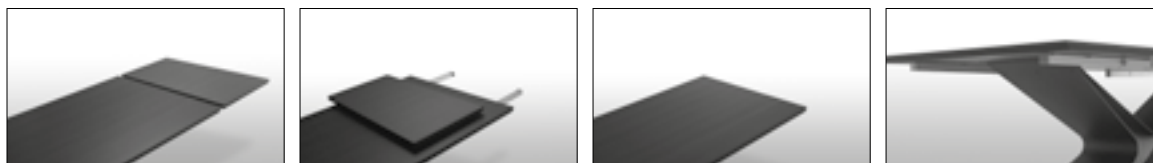

## Struttura in metallo verniciato

Coated metal frame / Structure en métal laqué

### Finiture struttura opaca di serie: Bianco Gesso - Antracite - Fango

Standard matt frame finishes: Chalk White - Anthracite - Mud

Finitions mates standard de la structure: Blanc Craie - Anthracite - Boue

### Maggiorazione per colore struttura optional (patella di copertina)

Surcharge for optional frame colour (see colour chart on cover)

Supplément pour coloris structure optionnel (voir rabat en couverture)

€ 350

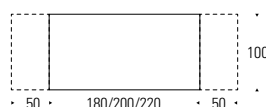
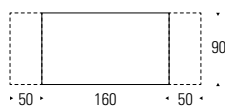

### Profilo piano materico bordo scaricato

Edge of textured top with bevelled edge

Chant plateau texturé incliné

	M <sup>3</sup>
160x90	1,04
180x100	1,14
200x100	1,24
220x100	1,34







**Materico bordo scaricato**  
Textured matt with sloping edge  
Texturé chant en pente

cod.

Sp. Thk/Ép.

3 cm

## One system

	<b>160 (210-260)x90</b> 63 (82-102)x36 inches	<b>TIF010</b>	<b>1.570</b>					
		Kg	81					
	<b>180 (230-280)x100</b> 70 (90-109)x39 inches	<b>TIF012</b>	<b>1.639</b>					
		Kg	90					
	<b>200 (250-300)x100</b> 78 (95-118)x39 inches	<b>TIF014</b>	<b>1.679</b>					
		Kg	92					
	<b>220 (270-320)x100</b> 85 (105-125)x39 inches	<b>TIF016</b>	<b>1.733</b>					
		Kg	94					

# Tiffany - Allungabile New up system

## New up system binario scorrevole e alzabile

New up system mechanism with sliding,  
lift-up track

New up system rail coulissant  
et relevable



## Struttura in metallo verniciato

Coated metal frame / Structure en métal laqué

### Finiture struttura opaca di serie: Bianco Gesso - Antracite - Fango

Standard matt frame finishes:  
Chalk White - Anthracite - Mud

Finitions mates standard de la structure :  
Blanc Craie - Anthracite - Boue

### Maggiorazione per colore struttura optional (patella di copertina)

Surcharge for optional frame colour  
(see colour chart on cover)

Supplément pour coloris structure  
optionnel (voir rabat en couverture)

€ 350

### Maggiorazione su ceramica Premium con allunghe in Bilia

Surcharge for Premium ceramic top with  
extension leaves in a matching pattern

Supplément pour céramique Premium  
avec allonges même aspect que plateau

€ 400

### Allunghe ceramica Elegance non disponibile in Bilia

Elegance ceramic extension leaves not available in a matching pattern  
Allonges en céramique Elegance non disponibles avec même aspect  
que le plateau



Profilo piano ceramica  
Ceramic top edge  
Chant plateau céramique

Profilo piano materico  
bordo scaricato  
Edge of textured top  
with bevelled edge  
Chant plateau texturé incliné

Profilo altri piani  
Edge for other tops  
Chant autres plateaux

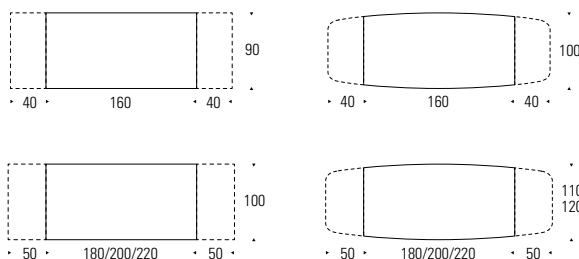

Indicare nell'ordine il colore  
del meccanismo se diverso  
dall'abbinamento consigliato (vedi pag. 6)  
Please specify the colour of the mechanism if it differs  
from the recommended pairings (see page 6)  
Indiquer dans la commande le coloris du mécanisme  
s'il est différent de l'association conseillée (voir page 6)

	M <sup>3</sup>		Materico Textured matt Texturé	Materico bordo scaricato Textured matt with sloping edge Texturé chant en pente	Vetro trasparente e fumé Clear and smoked glass Verre transparent et fumé	Glass decor	Ceramica Elegance Elegance Ceramic Céramique Elegance	Ceramica Premium Premium Ceramic Céramique Premium	
160x90	1,04		cod.	2 cm	2 cm	1,2 cm	1,2 cm	1,4 cm	1,4 cm
180x100	1,14								
200x100	1,24								
220x100	1,34								
Sp. Thk/Ép.									

## New up system Rettangolare

	<b>160 (200-240)x90</b> 63 (78-94)x36 inches	<b>TIFH10</b>	-	<b>2.336</b>	<b>3.382</b>	<b>3.581</b>	<b>3.835</b>	<b>4.172</b>
	Kg	-	78	88	88	99	99	
	<b>180 (230-280)x100</b> 70 (90-109)x39 inches	<b>TIFH12</b>	-	<b>2.451</b>	<b>3.559</b>	<b>3.685</b>	<b>4.007</b>	<b>4.378</b>
	Kg	-	90	95	95	117	117	
	<b>200 (250-300)x100</b> 78 (95-118)x39 inches	<b>TIFH14</b>	-	<b>2.514</b>	<b>3.619</b>	<b>3.792</b>	<b>4.100</b>	<b>4.472</b>
	Kg	-	94	110	110	123	123	
	<b>220 (270-320)x100</b> 85 (105-125)x39 inches	<b>TIFH16</b>	-	<b>2.537</b>	<b>3.651</b>	<b>3.858</b>	<b>4.211</b>	<b>4.587</b>
	Kg	-	98	120	120	130	130	

## New up system Botte

	<b>160 (200-240)x100</b> 63 (78-94)x39 inches	<b>TIFHB2</b>	<b>2.198</b>	-	<b>3.624</b>	<b>3.724</b>	<b>4.494</b>	<b>4.641</b>
	Kg	78	-	90	92	99	99	
	<b>180 (230-280)x110</b> 70 (90-109)x43 inches	<b>TIFHB3</b>	<b>2.406</b>	-	<b>3.761</b>	<b>3.960</b>	<b>5.274 *</b>	<b>5.513</b>
	Kg	90	-	96	97	117	117	
	<b>200 (250-300)x110</b> 78 (95-118)x43 inches	<b>TIFHB4</b>	<b>2.436</b>	-	<b>3.890</b>	<b>4.116</b>	<b>5.455 *</b>	<b>5.624</b>
	Kg	94	-	112	112	123	123	
	<b>220 (270-320)x120</b> 85 (105-125)x47 inches	<b>TIFHB6</b>	<b>2.517</b>	-	<b>4.078</b>	<b>4.452</b>	<b>5.561 *</b>	<b>5.719</b>
	Kg	98	-	122	125	130	130	

### \* Ceramica Elegance a botte solo su finitura Urban Marble 034 e Amani 035

Barrel-shaped Ceramica Elegance only available for Urban Marble 034 and Amani 035 finishes / Forme tonneau en Céramique Elegance uniquement dans les finitions Urban Marble 034 et Amani 035

# Tiffany - Allungabile Evo system

## Evo system apertura

Evo System mechanism

Evo system ouverture

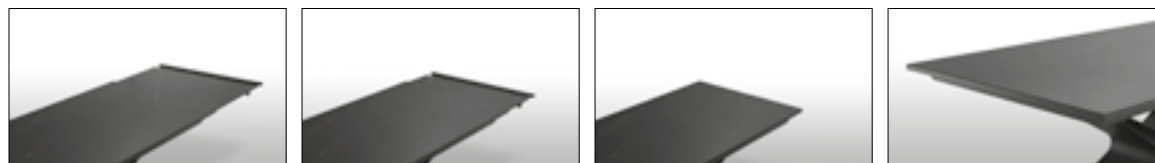

## Struttura in metallo verniciato

Coated metal frame / Structure en métal laqué

### Finiture struttura opaca di serie:

**Bianco Gesso - Antracite - Fango**

Standard matt frame finishes:  
Chalk White - Anthracite - Mud

Finitions mates standard de la structure :  
Blanc Craie - Anthracite - Boue

### Maggiorazione per colore struttura optional (patella di copertina)

Surcharge for optional frame colour  
(see colour chart on cover)

Supplément pour coloris structure optionnel (voir rabat en couverture)

€ 350

### Maggiorazione su ceramica Premium con allunghe in Bilia

Surcharge for Premium ceramic top with extension leaves in a matching pattern

Supplément pour céramique Premium avec allonges même aspect que plateau

€ 400



Profilo piano  
Profile top  
Chant plateau

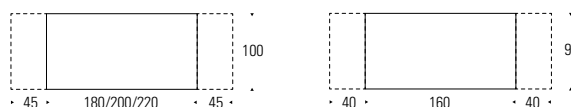

### Allunghe ceramica Elegance non disponibile in Bilia

Elegance ceramic extension leaves not available in a matching pattern

Allonges en céramique Elegance non disponibles avec même aspect que le plateau

	M <sup>3</sup>		Glass decor	Ceramica Elegance Elegance Ceramic Céramique Elegance	Ceramica Premium Premium Ceramic Céramique Premium			
160x90	1,04							
180x100	1,14							
200x100	1,24							
220x100	1,34							
			cod.					
			Sp. Thk/Ép.	0,6 cm	0,6 cm	0,6 cm		

## Evo system

	<b>160 (200-240)x90</b> 63 (78-94)x36 inches	<b>TIFV10</b>	<b>3.040</b>	<b>4.426</b>	<b>5.162</b>			
		Kg	77	103	103			
	<b>180 (225-270)x100</b> 70 (89-105)x39 inches	<b>TIFV12</b>	<b>3.152</b>	<b>4.785</b>	<b>5.518</b>			
		Kg	79	105	105			
	<b>200 (245-290)x100</b> 78 (97-114)x39 inches	<b>TIFV14</b>	<b>3.258</b>	<b>4.986</b>	<b>5.769</b>			
		Kg	82	108	110			
	<b>220 (265-310)x100</b> 85 (105-122)x39 inches	<b>TIFV16</b>	<b>3.336</b>	<b>5.158</b>	<b>5.991</b>			
		Kg	92	111	116			



# Vela - Fisso

## Vela tavolo fisso

Vela fixed table

Vela table fixe



## Struttura in metallo verniciato

Coated metal frame / Structure en métal laqué

### Finiture struttura opaca di serie:

#### Bianco Gesso - Antracite - Fango

Standard matt frame finishes:  
Chalk White - Anthracite - Mud

Finitions mates standard de la structure :  
Blanc Craie - Anthracite - Boue

### Maggiorazione per colore struttura optional (patella di copertina)

Surcharge for optional frame colour (see colour chart on cover)

Supplément pour coloris structure optionnel (voir rabat en couverture)

€ 350

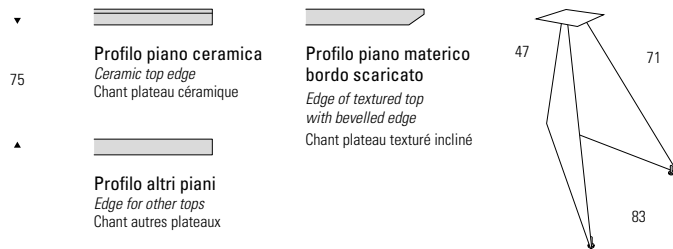
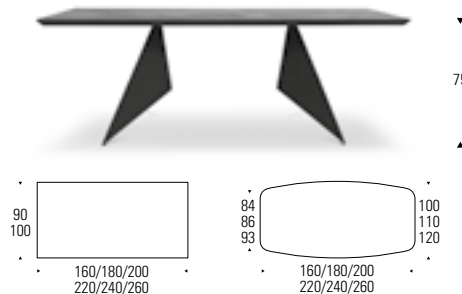

	M <sup>3</sup>
160x90	0,50
180x100	0,52
200x100	0,53
220x100	0,55
240x100/120	0,57
260x100/120	0,59



		Materico Textured matt Texturé	Materico bordo scaricato Textured matt with sloping edge Texturé chant en pente	Ceramica Elegance Elegance Ceramic Céramique Elegance	Ceramica Premium Premium Ceramic Céramique Premium	Basamento Base Piètement
	cod.					
	Sp. Thk/Ép.	2 cm	3 cm	1,4 cm	1,4 cm	

## Rettangolare

	<b>160x90</b> 63x36 inches	<b>VELF10</b>	-	<b>1.095</b>	<b>1.975</b>	<b>2.243</b>	<b>847</b>
		Kg	53	53	67	67	21
	<b>180x100</b> 70x39 inches	<b>VELF12</b>	-	<b>1.154</b>	<b>2.152</b>	<b>2.373</b>	<b>847</b>
		Kg	54	54	78	78	21
	<b>200x100</b> 78x39 inches	<b>VELF14</b>	-	<b>1.192</b>	<b>2.250</b>	<b>2.519</b>	<b>847</b>
		Kg	66	66	84	84	21
	<b>220x100</b> 85x39 inches	<b>VELF16</b>	-	<b>1.364</b>	<b>2.372</b>	<b>2.655</b>	<b>847</b>
		Kg	68	68	88	88	21
	<b>240x100</b> 94x39 inches	<b>VELF18</b>	-	<b>1.402</b>	<b>2.655</b>	<b>2.946</b>	<b>847</b>
		Kg	70	70	92	92	21
	<b>260x100</b> 101x39 inches	<b>VELF20</b>	-	<b>1.436</b>	<b>2.801</b>	<b>3.022</b>	<b>847</b>
		Kg	72	72	96	96	21

## Botte

	<b>160x100</b> 63x39 inches	<b>VELFB2</b>	<b>1.141</b>	-	<b>2.387</b>	<b>2.440</b>	<b>847</b>
		Kg	53	53	67	67	21
	<b>180x110</b> 70x43 inches	<b>VELFB3</b>	<b>1.206</b>	-	<b>3.167 *</b>	<b>3.273</b>	<b>847</b>
		Kg	54	54	78	78	21
	<b>200x110</b> 78x43 inches	<b>VELFB4</b>	<b>1.226</b>	-	<b>3.260 *</b>	<b>3.364</b>	<b>847</b>
		Kg	66	66	84	84	21
	<b>220x120</b> 85x47 inches	<b>VELFB6</b>	<b>1.402</b>	-	<b>3.330 *</b>	<b>3.430</b>	<b>847</b>
		Kg	68	68	88	88	21
	<b>240x120</b> 94x47 inches	<b>VELFB7</b>	<b>1.427</b>	-	<b>3.599 *</b>	<b>3.709</b>	<b>847</b>
		Kg	70	70	92	92	21
	<b>260x120</b> 101x47 inches	<b>VELFB8</b>	<b>1.472</b>	-	<b>3.727 *</b>	<b>3.827</b>	<b>847</b>
		Kg	72	72	96	96	21

### \* Ceramica Elegance a botte solo su finitura Urban Marble 034 e Amani 035

Barrel-shaped Ceramica Elegance only available for Urban Marble 034 and Amani 035 finishes / Forme tonneau en Céramique Elegance uniquement dans les finitions Urban Marble 034 et Amani 035

# Vela - Allungabile One system

## One system staffe estraibili con allunghe esterne

One system mechanism with pull-out brackets and external extension leaves

One system bras extractibles avec allonges séparées

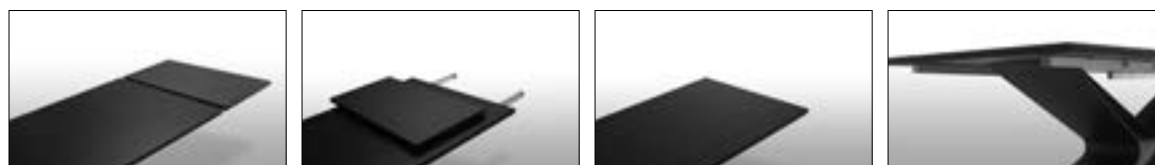

## Struttura in metallo verniciato

Coated metal frame / Structure en métal laqué

### Finiture struttura opaca di serie: Bianco Gesso - Antracite - Fango

Standard matt frame finishes: Chalk White - Anthracite - Mud

Finitions mates standard de la structure: Blanc Craie - Anthracite - Boue

### Maggiorazione per colore struttura optional (patella di copertina)

Surcharge for optional frame colour (see colour chart on cover)

Supplément pour coloris structure optionnel (voir rabat en couverture)

€ 350



75

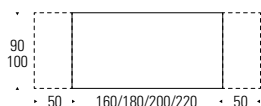

Profilo piano materico bordo scaricato

Edge of textured top with bevelled edge

Chant plateau texturé incliné

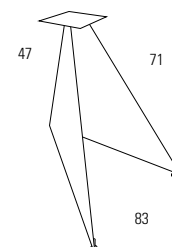

	M <sup>3</sup>
160x90	0,50
180x100	0,52
200x100	0,53
220x100	0,55



**Materico bordo scaricato**  
Textured matt with sloping edge  
Texturé chant en pente

cod.

Sp. Thk/Ép.

3 cm

## One system

	<b>160 (210-260)x90</b> 63 (83-102)x36 inches	<b>VELO10</b>	<b>1.611</b>				
		Kg	71				
	<b>180 (230-280)x100</b> 70 (90-109)x39 inches	<b>VELO12</b>	<b>1.681</b>				
		Kg	74				
	<b>200 (250-300)x100</b> 78 (95-118)x39 inches	<b>VELO14</b>	<b>1.721</b>				
		Kg	86				
	<b>220 (270-320)x100</b> 85 (105-125)x39 inches	<b>VELO16</b>	<b>1.775</b>				
		Kg	86				

# Vela - Allungabile New up system

## New up system binario scorrevole e alzabile

New up system mechanism with sliding,  
lift-up track

New up system rail coulissant  
et relevable



## Struttura in metallo verniciato

Coated metal frame / Structure en métal laqué

### Finiture struttura opaca di serie: Bianco Gesso - Antracite - Fango

Standard matt frame finishes:  
Chalk White - Anthracite - Mud

Finitions mates standard de la structure :  
Blanc Craie - Anthracite - Boue

### Maggiorazione per colore struttura optional (patella di copertina)

Surcharge for optional frame colour  
(see colour chart on cover)

Supplément pour coloris structure  
optionnel (voir rabat en couverture)

€ 350

### Maggiorazione su ceramica Premium con allunghe in Bilia

Surcharge for Premium ceramic top with  
extension leaves in a matching pattern

Supplément pour céramique Premium  
avec allonges même aspect que plateau

€ 400



75



Profilo piano ceramica  
Ceramic top edge  
Chant plateau céramique



Profilo piano materico  
bordo scaricato  
Edge of textured top  
with bevelled edge  
Chant plateau texturé incliné

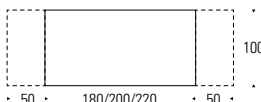
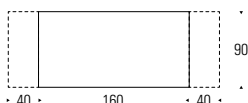
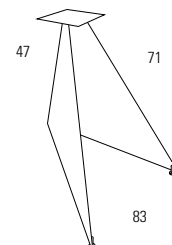

Indicare nell'ordine il colore  
del meccanismo se diverso  
dall'abbinamento consigliato (vedi pag. 6)

Please specify the colour of the mechanism if it differs  
from the recommended pairings (see page 6)

Indiquer dans la commande le coloris du mécanisme  
s'il est différent de l'association conseillée (voir page 6)

### Allunghe ceramica Elegance non disponibile in Bilia

Elegance ceramic extension leaves not available in a matching pattern

Allonges en céramique Elegance non disponibles avec même aspect  
que le plateau

	M <sup>3</sup>
160x90	0,56
180x100	0,58
200x100	0,60
220x100	0,62



	cod.	Materico bordo scaricato Textured matt with sloping edge Texturé chant en pente	Ceramica Elegance Elegance Ceramic Céramique Elegance	Ceramica Premium Premium Ceramic Céramique Premium			
Sp. Thk/Ép.		2 cm	1,4 cm	1,4 cm			

## New up system

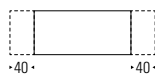

**160 (200-240)x90**  
63 (78-94) x36 inches

VELH10

2.585

4.048

4.365

Kg

72

110

110

**180 (230-280)x100**  
70 (90-109)x39 inches

VELH12

2.680

4.217

4.587

Kg

84

116

116

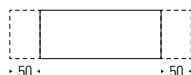

**200 (250-300)x100**  
78 (95-118)x39 inches

VELH14

2.726

4.308

4.759

Kg

96

122

122

**220 (270-320)x100**  
85 (105-125)x39 inches

VELH16

2.770

4.416

4.875

Kg

98

126

126

# Wave - Fisso

## Wave tavolo fisso

Wave fixed table

Wave table fixe



## Struttura in metallo verniciato

Coated metal frame / Structure en métal laqué

### Finiture struttura opaca di serie: Bianco Gesso - Antracite - Fango

Standard matt frame finishes:  
Chalk White - Anthracite - Mud

Finitions mates standard de la structure :  
Blanc Craie - Anthracite - Boue

Maggiorazione per colore struttura  
optional (patella di copertina)

Surcharge for optional frame colour  
(see colour chart on cover)

Supplément pour coloris structure  
optionnel (voir rabat en couverture)

€ 350



75

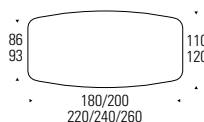
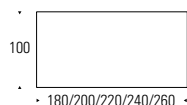

Profilo altri piani  
Edge for other tops  
Chant autres plateaux



Profilo piano materico  
bordo scaricato  
Edge of textured top  
with bevelled edge  
Chant plateau texturé incliné



Profilo piano ceramica  
Ceramic top edge  
Chant plateau céramique

	M <sup>3</sup>
180x100	0,60
200x100	0,62
220x100	0,65
240x100	0,67
260x100	0,69



		Materico Textured matt Texturé	Materico bordo scaricato Textured matt with sloping edge Texturé chant en pente	Ceramica Elegance Elegance Ceramic Céramique Elegance	Ceramica Premium Premium Ceramic Céramique Premium	Basamento Base Piètement
Sp. Thk/Ép.	cod.	2 cm	3 cm	1,4 cm	1,4 cm	

## Rettangolare

	<b>180x100</b> 70x39 inches	<b>WAVF12</b>	-	<b>1.306</b>	<b>2.238</b>	<b>2.427</b>	<b>1.012</b>
		Kg		63	89	89	
	<b>200x100</b> 78x39 inches	<b>WAVF14</b>	-	<b>1.345</b>	<b>2.314</b>	<b>2.580</b>	<b>1.012</b>
		Kg		75	99	99	
	<b>220x100</b> 85x39 inches	<b>WAVF16</b>	-	<b>1.516</b>	<b>2.412</b>	<b>2.671</b>	<b>1.012</b>
	Kg		77	105	105		
<b>240x100</b> 94x39 inches	<b>WAVF18</b>	-	<b>1.555</b>	<b>2.646</b>	<b>2.957</b>	<b>1.012</b>	
	Kg		79	110	110		
<b>260x100</b> 102x39 inches	<b>WAVF20</b>	-	<b>1.589</b>	<b>2.786</b>	<b>3.115</b>	<b>1.012</b>	
	Kg		81	114	114		

## Botte

	<b>180x110</b> 70x43 inches	<b>WAVFB3</b>	<b>1.359</b>	-	<b>3.319</b>	<b>3.425</b>	<b>1.012</b>
		Kg	63				
	<b>200x110</b> 78x43 inches	<b>WAVFB4</b>	<b>1.379</b>	-	<b>3.412</b>	<b>3.516</b>	<b>1.012</b>
		Kg	75				
	<b>220x120</b> 85x47 inches	<b>WAVFB6</b>	<b>1.555</b>	-	<b>3.485</b>	<b>3.582</b>	<b>1.012</b>
	Kg	77					
<b>240x120</b> 94x47 inches	<b>WAVFB7</b>	<b>1.580</b>	-	<b>3.750</b>	<b>3.860</b>	<b>1.012</b>	
	Kg	79					
<b>260x120</b> 101x47 inches	<b>WAVFB8</b>	<b>1.624</b>	-	<b>3.879</b>	<b>3.979</b>	<b>1.012</b>	
	Kg	81					

# Wave - Allungabile One system

## One system staffe estraibili con allunghe esterne

One system mechanism with pull-out brackets and external extension leaves

One system bras extractibles avec allonges séparées

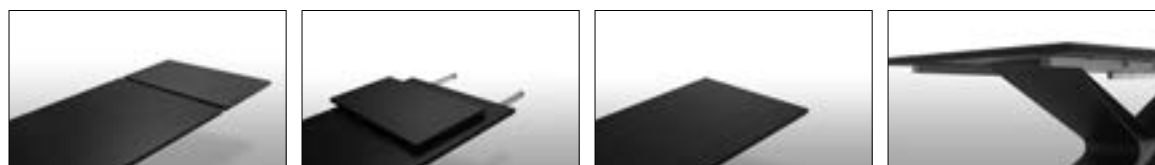

## Struttura in metallo verniciato

Coated metal frame / Structure en métal laqué

### Finiture struttura opaca di serie: Bianco Gesso - Antracite - Fango

Standard matt frame finishes: Chalk White - Anthracite - Mud

Finitions mates standard de la structure: Blanc Craie - Anthracite - Boue

### Maggiorazione per colore struttura optional (patella di copertina)

Surcharge for optional frame colour (see colour chart on cover)

Supplément pour coloris structure optionnel (voir rabat en couverture)

€ 350



▼  
75  
▲



Profilo piano materico bordo scaricato

Edge of textured top with bevelled edge

Chant plateau texturé incliné

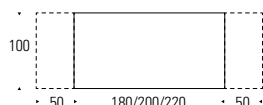

	M <sup>3</sup>
180x100	0,60
200x100	0,62
220x100	0,65



Sp. Thk/Ép.	cod.	Materico bordo scaricato Textured matt with sloping edge Texturé chant en pente				
		3 cm				

## One system

	<b>180 (230-280)×100</b> 70 (90-109)×39 inches	<b>WAV012</b> Kg	<b>1.803</b> 83			
	<b>200 (250-300)×100</b> 78 (95-118)×39 inches	<b>WAV014</b> Kg	<b>1.842</b> 95			
	<b>220 (270-320)×100</b> 85 (105-125)×39 inches	<b>WAV016</b> Kg	<b>1.895</b> 97			

# Wave - Allungabile New up system

## New up system binario scorrevole e alzabile

New up system mechanism with sliding,  
lift-up track

New up system rail coulissant  
et relevable



## Struttura in metallo verniciato

Coated metal frame / Structure en métal laqué

### Finiture struttura opaca di serie: Bianco Gesso - Antracite - Fango

Standard matt frame finishes:  
Chalk White - Anthracite - Mud

Finitions mates standard de la structure :  
Blanc Craie - Anthracite - Boue

### Maggiorazione per colore struttura optional (patella di copertina)

Surcharge for optional frame colour  
(see colour chart on cover)

Supplément pour coloris structure  
optionnel (voir rabat en couverture)

€ 350

### Maggiorazione su ceramica Premium con allunghe in Bilia

Surcharge for Premium ceramic top with  
extension leaves in a matching pattern

Supplément pour céramique Premium  
avec allonges même aspect que plateau

€ 400



▼

75

▲

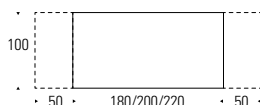

Profilo piano ceramica  
Ceramic top edge  
Chant plateau céramique



Profilo piano materico  
bordo scaricato  
Edge of textured top  
with bevelled edge  
Chant plateau texturé incliné

Indicare nell'ordine il colore  
del meccanismo se diverso  
dall'abbinamento consigliato (vedi pag. 6)  
Please specify the colour of the mechanism if it differs  
from the recommended pairings (see page 6)  
Indiquer dans la commande le coloris du mécanisme  
s'il est différent de l'association conseillée (voir page 6)

### Allunghe ceramica Elegance non disponibile in Bilia

Elegance ceramic extension leaves not available in a matching pattern  
Allonges en céramique Elegance non disponibles avec même aspect  
que le plateau

	M <sup>3</sup>
180x100	0,60
200x100	0,62
220x100	0,65



	cod.	Materico bordo scaricato Textured matt with sloping edge Texturé chant en pente	Ceramica Elegance Elegance Ceramic Céramique Elegance	Ceramica Premium Premium Ceramic Céramique Premium		
Sp. Thk/Ép.		2 cm	1,4 cm	1,4 cm		

## New up system

	<b>180 (230-280)x100</b> 70 (90-109)x39 inches	<b>WAVH12</b>	<b>2.470</b>	<b>4.096</b>	<b>4.383</b>		
		Kg	93	93	127		
	<b>200 (250-300)x100</b> 78 (95-118)x39 inches	<b>WAVH14</b>	<b>2.536</b>	<b>4.187</b>	<b>4.551</b>		
	Kg	105	105	137			
<b>220 (270-320)x100</b> 85 (105-125)x39 inches	<b>WAVH16</b>	<b>3.728</b>	<b>4.296</b>	<b>4.663</b>			
	Kg	107	107	143			

# Zoe round - Fisso

## Zoe round tavolo fisso

Zoe round fixed table

Zoe round table fixe

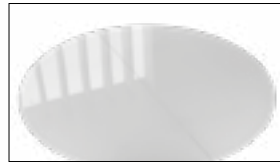

## Struttura in metallo verniciato

Coated metal frame / Structure en métal laqué

### Finiture struttura opaca di serie: Bianco Gesso - Antracite - Fango

Standard matt frame finishes:  
Chalk White - Anthracite - Mud

Finitions mates standard de la structure :  
Blanc Craie - Anthracite - Boue

### Maggiorazione per colore struttura optional (patella di copertina)

Surcharge for optional frame colour  
(see colour chart on cover)

Supplément pour coloris structure  
optionnel (voir rabat en couverture)

€ 200

Al telaio  
To the top under-frame  
H. sol-ceinture 71,5



76



• 120/140 •



Profilo piano ceramica  
Ceramic top edge  
Chant plateau céramique



Profilo altri piani  
Edge for other tops  
Chant autres plateaux

	M <sup>3</sup>
Ø 120	0,42
Ø 140	0,53



	cod.	Materico Textured matt Texturé	Vetro lucido bianco gesso Gloss glass chalk white Verre brillant blanc craie	Ceramica Premium Premium Ceramic Céramique Premium			
Sp. Thk/Ép.		2 cm	1 cm	1,4 cm			

## Rotondo

	Ø 120 47 inches	ZORFR1	986	2.045	2.426		
		Kg	62	70	72		
	Ø 140 55 inches	ZORFR2	1.081	2.494	2.709		
		Kg	67	75	77		

# Zoe round - Allungabile Book system

## Book system apertura telescopica del piano

Book System mechanism with telescopic tabletop

Book system ouverture télescopique du plateau



## Struttura in metallo verniciato

Coated metal frame / Structure en métal laqué

### Finiture struttura opaca di serie: Bianco Gesso - Antracite - Fango

Standard matt frame finishes: Chalk White - Anthracite - Mud

Finitions mates standard de la structure : Blanc Craie - Anthracite - Boue

### Maggiorazione per colore struttura optional (patella di copertina)

Surcharge for optional frame colour (see colour chart on cover)

Supplément pour coloris structure optionnel (voir rabat en couverture)

€ 200



75

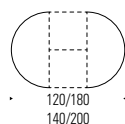

Profilo piano ceramica  
Ceramic top edge  
Chant plateau céramique



Profilo altri piani  
Edge for other tops  
Chant autres plateaux

	M <sup>3</sup>		MT 1/ONE	MT Premium MT Special	Vetro lucido bianco gesso Gloss glass chalk white Verre brillant blanc craie	Ceramica Premium Premium Ceramic Céramique Premium		
Ø 120	0,42							
Ø 140	0,53							
			cod.					
			Sp. Thk/Ép.	2 cm	1 cm	1,4 cm		

## Book system

	Ø 120 (180) 47 (71) inches	ZORBR1	1.764	2.792	3.193			
		Kg	90	92	92			
	Ø 140 (200) 55 (78) inches	ZORBR2	1.811	3.115	3.465			
		Kg	98	100	100			

### Allunghe in tinta con piano in materico. Sulla versione in vetro piano allunghe in materico bianco gesso.

Per la versione in ceramica allunghe in materico in tinta con il bordo del piano.

For model with a textured top, the extension leaves are made to match. For models with a glass top, the extension leaves have a textured Chalk White finish.

For the ceramic version the extension leaves are in textured matching the colour of the top's edge.

Allonges assorties à la finition du plateau texturé. Pour la version avec plateau en verre, les allonges sont réalisées en texturé blanc craie.

Pour la version en céramique, allonges en texturé assorties au chant du plateau.



# Console



# Fiesta Console - allungabile

Struttura in materico Rovere Nodato chiaro, Noce ambr, Cemento chiaro, Poro aperto bianco

Frame in textured Light Knotted Oak, Amber Walnut, Light Cement, White open pore

Structure en texturé Chêne à nœuds clair, Noyer ambr, Ciment clair ou Pores ouverts blanc

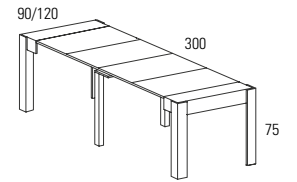
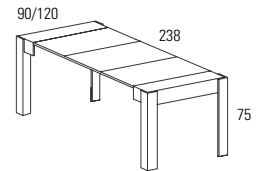

## Finiture struttura:

**Materico Rovere Nodato chiaro,  
Noce ambr, Cemento chiaro, Poro aperto bianco**

Frame finishes:

Textured Light Knotted Oak, Amber Walnut,  
Light Cement, White open pore

Finitions structure:

Structure en texturé Chêne à nœuds clair,  
Noyer ambr, Ciment clair ou Pores ouverts blanc



## Allunghe riposte sullo schienale

Extension leaves stored at the back - Allonges logées dans le panneau arrière

	M <sup>3</sup>						
52/238x90	0,45		<b>Materici Rovere Nodato chiaro, Noce ambr, Cemento chiaro, Poro aperto bianco</b>	Textured Light Knotted Oak, Amber Walnut, Light Cement, Open-pore White	Texturés Chêne à nœuds clair, Noyer ambr, Ciment clair, Pores ouverts blanc	cod.	2 cm
52/300x90	0,50						
52/238x120	0,60						
52/300x120	0,63						
<b>Sp. Thk/Ép.</b>							

### 52/238x90

	<b>52 (114-176-238)x90</b> 20(45-69-94)x36 inches	<b>FIEC01</b>	<b>1.566</b>				
		Kg	54				

### 52/300x90

	<b>52 (114-176-238-300)x90</b> 20(45-69-94-118)x36 inches	<b>FIEC02</b>	<b>1.969</b>				
		Kg	65				
<b>Gamba centrale con rotellina</b> Central leg on castor - Pied central avec roulette							

### 52/238x120

	<b>52 (114-176-238)x120</b> 20(45-69-94)x39 inches	<b>FIEC03</b>	<b>1.594</b>				
		Kg	60				

### 52/300x120

	<b>52 (114-176-238-300)x120</b> 20(45-69-94-118)x39 inches	<b>FIEC04</b>	<b>2.050</b>				
		Kg	71				
<b>Gamba centrale con rotellina</b> Central leg on castor - Pied central avec roulette							

# Giravolta Console - allungabile

Struttura materico

Textured frame/Structure texturée

**Finiture struttura:  
Opaco Antracite**

Frame finishes:  
Matt Anthracite

Finition structure:  
Anthracite Mat

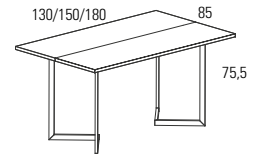
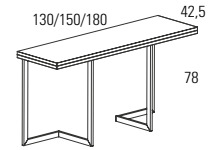

	M <sup>3</sup>
130x42,5/85	0,23
150x42,5/85	0,24
180x42,5/85	0,26



**Materici Rovere Nodato chiaro,  
Noce ambrata, Cemento chiaro,  
Poro aperto bianco**  
*Textured Light Knotted Oak, Amber Walnut,  
Light Cement, Open-pore White*  
*Texturés Chêne à nœuds clair, Noyer ambré,  
Ciment clair, Pores ouverts blanc*

Sp. Thk/Ép.

2 cm

## 130x42,5/85



**130x42,5/85**  
51x17/34 inches

**GIRA13**

**981**

Kg

35

## 150x42,5/85



**150x42,5/85**  
51x17/34 inches

**GIRA15**

**1.078**

Kg

38

## 180x42,5/85



**180x42,5/85**  
70x17/34 inches

**GIRA18**

**1.152**

Kg

42



**Sedie  
Poltroncine  
Sgabelli**



- 1/One** Amsterdam / Bora / Dublin / Easy / Maracaibo / Nairobi / Texplast / Ecopelle Twist *Twist eco-leather - Éco-cuir Twist*
- A** Boston / Spice / Marvel / Swing / Cotton / Tessuto cliente minimo 4 pz.  
*Customer fabric, min. 4 pcs - Tissu client minimum 4 articles*
- B** Cachemire / Daytona / Econabuk / Sogno / Ecopelle Vintage *Vintage eco-leather - Éco-cuir Vintage*  
 Pelle cliente minimo 4 pz. *Min. 4 pcs must be ordered with customer's leather - Pour cuir du client, minimum 4 articles.*
- F** Pelle Polo

\* Non disponibile in Texplast  
*Not available in Texplast*  
 Non disponible en Texplast

	cod.	Cat. 1/ONE	Cat. A	Cat. B	Cat. F
--	------	------------	--------	--------	--------

## Abba - L 46 P 56 H 89/47



**N.B.: Piedino con feltro opzionale**  
*N.B.: Optional felt-padded foot - N.B.: Option pied avec patin feutre*

Kg 5,6 | M<sup>3</sup> 0,50 | Tessuto/Fabric/Tissu ml. 1,1 - pelle/leather/cuir m<sup>2</sup> 1,85

### Struttura metallo

*Metal frame - Structure métal:*

Opaco bianco gesso - Opaco antracite - Fango  
*Matt Chalk White - Matt Anthracite - Mud*  
 Blanc craie Mat - Anthracite Mat - Boue

ABBMET

286  
\*

314

332

493

▲ **Maggiorazione per finitura metallo optional**  
*Surcharge for optional metal finish* + 60  
 Supplément pour finition métal optionnelle

Per imballo/ordine 1 pz.  
*For 1-piece package/order - Pour emballage/commande 1 chaise* + 20



## Adele - L 47 P 57 H 100/47



**N.B.: Piedino con feltro NON applicabile**  
*N.B.: Felt-padded foot NOT available - N.B.: Pied avec patin feutre NON utilisable*

Kg 6,8 | M<sup>3</sup> 0,40 | Tessuto/Fabric/Tissu ml. 1,1 - pelle/leather/cuir m<sup>2</sup> 1,85

### Struttura legno

*Wooden frame - Structure bois:*

Faggio tinto (naturale, carbone, termocotto)  
*Stained beech (Natural, Charcoal or Heat-treated)*  
 Hêtre teinté (nature, charbon, thermo-traité)

ADEFRF

213  
\*

222

247

416

Per imballo/ordine 1 pz.  
*For 1-piece package/order - Pour emballage/commande 1 chaise* + 20



## Alice - L 43 P 53 H 94/47



**N.B.: Piedino con feltro opzionale**  
*N.B.: Optional felt-padded foot - N.B.: Option pied avec patin feutre*

Kg 5,8 | M<sup>3</sup> 0,35 | Tessuto/Fabric/Tissu ml. 0,7 - pelle/leather/cuir m<sup>2</sup> 1,3

### Struttura metallo

*Metal frame - Structure métal:*

Opaco bianco gesso - Opaco antracite - Fango  
*Matt Chalk White - Matt Anthracite - Mud*  
 Blanc craie Mat - Anthracite Mat - Boue

ALIMET

190  
\*

204

211

369

▲ **Maggiorazione per finitura metallo optional**  
*Surcharge for optional metal finish* + 60  
 Supplément pour finition métal optionnelle

Per imballo/ordine 1 pz.  
*For 1-piece package/order - Pour emballage/commande 1 chaise* + 20



## Arisa - L 51 P 58 H 83/48



**N.B.: Sedia fornita smontata - N.B.: Piedino con feltro opzionale**  
*N.B.: Chair supplied unassembled - N.B.: Optional felt-padded foot - N.B.: Chaise fournie démontée - N.B.: Pied avec patin feutre optionnellefeutre*

Kg 7 | M<sup>3</sup> 0,24 | Tessuto/Fabric/Tissu ml. 1,3 - pelle/leather/cuir m<sup>2</sup> 2,2

### Struttura metallo

*Metal frame - Structure métal:*

Opaco bianco gesso - Opaco antracite - Fango  
*Matt Chalk White - Matt Anthracite - Mud*  
 Blanc craie Mat - Anthracite Mat - Boue

ARIMET

369  
\*

390

413

570

▲ **Maggiorazione per finitura metallo optional**  
*Surcharge for optional metal finish* + 60  
 Supplément pour finition métal optionnelle

Per imballo/ordine 1 pz.  
*For 1-piece package/order - Pour emballage/commande 1 chaise* + 20



# Sedie / Chairs / Chaises

▲ N.B. Finiture pag. 90

N.B.: Finishes page 90

N.B.: Finitions page 90

1/One Amsterdam / Bora / Dublin / Easy / Maracaibo / Nairobi / Texplast / Ecopelle Twist *Twist eco-leather* - Éco-cuir Twist

A Boston / Spice / Marvel / Swing / Cotton / Tessuto cliente minimo 4 pz.

Customer fabric, min. 4 pcs - Tissu client minimum 4 articles

B Cachemire / Daytona / Econabuk / Sogno / Ecopelle Vintage *Vintage eco-leather* - Éco-cuir Vintage

Pelle cliente minimo 4 pz. Min. 4 pcs must be ordered with customer's leather - Pour cuir du client, minimum 4 articles.

F Pelle Polo

\* Non disponibile in Texplast

Not available in Texplast

Non disponible en Texplast

	cod.	Cat. 1/ONE	Cat. A	Cat. B	Cat. F
--	------	------------	--------	--------	--------

## Arisa bicolor - L 51 P 58 H 83/48



**Tessuto A**  
Fabric A  
Tissu A

**Tessuto B**  
Fabric B  
Tissu B

### Struttura metallo

Metal frame - Structure métal:

Opaco bianco gesso - Opaco antracite - Fango  
Matt Chalk White - Matt Anthracite - Mud  
Blanc craie Mat - Anthracite Mat - Boue

▲ Maggiorazione per finitura metallo optional  
Surcharge for optional metal finish  
Supplément pour finition métal optionnelle **+ 60**

Per imballo/ordine 1 pz. **+ 20**

For 1-piece package/order - Pour emballage/commande 1 chaise

ARIBCK

391  
\*

412

435

592

Per finiture miste seduta/schienale e scocca fare riferimento alla fascia di prezzo più alta tra le due varianti scelte

For mixed seat/back and frame finishes please refer to the highest price category of the two versions chosen

Pour des finitions mixtes pour l'assise/dossier et la coque, se référer à la catégorie de prix la plus haute entre les deux variantes choisies

N.B.: Sedia fornita smontata - N.B.: Piedino con feltro opzionale

N.B.: Chair supplied unassembled - N.B.: Optional felt-padded foot - N.B.: Chaise fournie démontée - N.B.: Pied avec patin feutre optionnel feutre



Kg 7 | M<sup>3</sup> 0,24 | Tessuto/Fabric/Tissu ml. 1,3 - pelle/leather/cuir m<sup>2</sup> 2,2

## Asia - L 46 P 56 H 83/47



### Struttura metallo

Metal frame - Structure métal:

Opaco bianco gesso - Opaco antracite - Fango  
Matt Chalk White - Matt Anthracite - Mud  
Blanc craie Mat - Anthracite Mat - Boue

▲ Maggiorazione per finitura metallo optional  
Surcharge for optional metal finish  
Supplément pour finition métal optionnelle **+ 60**

Per imballo/ordine 1 pz. **+ 20**

For 1-piece package/order - Pour emballage/commande 1 chaise

ASIMET

263  
\*

270

290

447

N.B.: Piedino con feltro NON applicabile

N.B.: Felt-padded foot NOT available - N.B.: Pied avec patin feutre NON utilisable



Kg 5,9 | M<sup>3</sup> 0,42 | Tessuto/Fabric/Tissu ml. 1,2 - pelle/leather/cuir m<sup>2</sup> 2

## Astoria - L 56 P 56 H 85/47



### Struttura metallo

Metal frame - Structure métal:

Opaco bianco gesso - Opaco antracite - Fango  
Matt Chalk White - Matt Anthracite - Mud  
Blanc craie Mat - Anthracite Mat - Boue

▲ Maggiorazione per finitura metallo optional  
Surcharge for optional metal finish  
Supplément pour finition métal optionnelle **+ 60**

Per imballo/ordine 1 pz. **+ 20**

For 1-piece package/order - Pour emballage/commande 1 chaise

ASTMET

314  
\*

346

373

517

No tessuto  
Daytona  
Daytona fabric  
not available  
Sauf tissu Daytona

N.B.: Piedino con feltro opzionale

N.B.: Optional felt-padded foot - N.B.: Option pied avec patin feutre



Kg 8,0 | M<sup>3</sup> 0,50 | Tessuto/Fabric/Tissu ml. 1,5 - pelle/leather/cuir m<sup>2</sup> 2,2

## Camilla - L 47 P 57 H 100/47



### Struttura legno

Wooden frame - Structure bois:

Faggio tinto (naturale, carbone, termocotto)  
Stained beech (Natural, Charcoal or Heat-treated)  
Hêtre teinté (nature, charbon, thermo-traité)

Rivestimento aggiuntivo  
Additional upholstery - Revêtement supplémentaire

Per imballo/ordine 1 pz. **+ 20**

For 1-piece package/order - Pour emballage/commande 1 chaise

CAMFRC

269

289

343

-

CAMCUF

163

183

237

-

N.B.: Piedino con feltro NON applicabile

N.B.: Felt-padded foot NOT available - N.B.: Pied avec patin feutre NON utilisable



Kg 7 | M<sup>3</sup> 0,42 | Tessuto/Fabric/Tissu ml. 2,15

# Sedie / Chairs / Chaises

▲ N.B. Finiture pag. 90

N.B.: Finishes page 90

N.B.: Finitions page 90

**1/One** Amsterdam / Bora / Dublin / Easy / Maracaibo / Nairobi / Texplast / Ecopelle Twist *Twist eco-leather - Éco-cuir Twist*

**A** Boston / Spice / Marvel / Swing / Cotton / Tessuto cliente minimo 4 pz.

*Customer fabric, min. 4 pcs - Tissu client minimum 4 articles*

**B** Cachemire / Daytona / Econabuk / Sogno / Ecopelle Vintage *Vintage eco-leather - Éco-cuir Vintage*

*Pelle cliente minimo 4 pz. Min. 4 pcs must be ordered with customer's leather - Pour cuir du client, minimum 4 articles.*

**F** Pelle Polo

\* Non disponibile in Texplast

*Not available in Texplast*

*Non disponible en Texplast*

	cod.	Cat. 1/ONE	Cat. A	Cat. B	Cat. F
--	------	------------	--------	--------	--------

## Carol - L 51 P 56 H 83/48

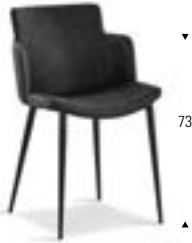

73

### Struttura metallo

*Metal frame - Structure métal:*

Opaco bianco gesso - Opaco antracite - Fango

*Matt Chalk White - Matt Anthracite - Mud*

Blanc craie Mat - Anthracite Mat - Boue

CARMET

432

442

467

644

▲ **Maggiorazione per finitura metallo optional**

*Surcharge for optional metal finish*

Supplément pour finition métal optionnelle

+ 60

Per imballo/ordine 1 pz.

*For 1-piece package/order - Pour emballage/commande 1 chaise*

+ 20

**N.B.: Sedia fornita smontata - N.B.: Piedino con feltro opzionale**

*N.B.: Chair supplied unassembled - N.B.: Optional felt-padded foot - N.B.: Chaise fournie démontée - N.B.: Pied avec patin feutre optionnel*



Kg 6,9 | M<sup>3</sup> 0,24 | Tessuto/Fabric/Tissu ml. 1,6 - pelle/leather/cuir m<sup>2</sup> 2,2

## Chicco - L 48 P 57 H 86/47



### Struttura metallo

*Metal frame - Structure métal:*

Opaco bianco gesso - Opaco antracite - Fango

*Matt Chalk White - Matt Anthracite - Mud*

Blanc craie Mat - Anthracite Mat - Boue

CHIMET

299

306

327

487

▲ **Maggiorazione per finitura metallo optional**

*Surcharge for optional metal finish*

Supplément pour finition métal optionnelle

+ 60

Per imballo/ordine 1 pz.

*For 1-piece package/order - Pour emballage/commande 1 chaise*

+ 20

**N.B.: Piedino con feltro NON applicabile**

*N.B.: Felt-padded foot NOT available - N.B.: Pied avec patin feutre NON utilisable*



Kg 6,7 | M<sup>3</sup> 0,42 | Tessuto/Fabric/Tissu ml. 1,3 - pelle/leather/cuir m<sup>2</sup> 2,4

## Cloe - L 50 P 63 H 89/47



### Struttura metallo

*Metal frame - Structure métal:*

Opaco bianco gesso - Opaco antracite - Fango

*Matt Chalk White - Matt Anthracite - Mud*

Blanc craie Mat - Anthracite Mat - Boue

CLOMET

390

399

424

593

▲ **Maggiorazione per finitura metallo optional**

*Surcharge for optional metal finish*

Supplément pour finition métal optionnelle

+ 60

Per imballo/ordine 1 pz.

*For 1-piece package/order - Pour emballage/commande 1 chaise*

+ 20

**N.B.: Piedino con feltro NON applicabile**

*N.B.: Felt-padded foot NOT available - N.B.: Pied avec patin feutre NON utilisable*



Kg 6,5 | M<sup>3</sup> 0,47 | Tessuto/Fabric/Tissu ml. 1 - pelle/leather/cuir m<sup>2</sup> 2,2

## Diva - L 45 P 57 H 99/48



### Struttura metallo

*Metal frame - Structure métal:*

Opaco bianco gesso - Opaco antracite - Fango

*Matt Chalk White - Matt Anthracite - Mud*

Blanc craie Mat - Anthracite Mat - Boue

DIVMET

327

338

360

516

▲ **Maggiorazione per finitura metallo optional**

*Surcharge for optional metal finish*

Supplément pour finition métal optionnelle

+ 60

Per imballo/ordine 1 pz.

*For 1-piece package/order - Pour emballage/commande 1 chaise*

+ 20

**N.B.: Piedino con feltro NON applicabile**

*N.B.: Felt-padded foot NOT available - N.B.: Pied avec patin feutre NON utilisable*



Kg 6 | M<sup>3</sup> 0,42 | Tessuto/Fabric/Tissu ml. 1,4 - pelle/leather/cuir m<sup>2</sup> 2,2



- 1/One** Amsterdam / Bora / Dublin / Easy / Maracaibo / Nairobi / Texplast / Ecopelle Twist *Twist eco-leather - Éco-cuir Twist*
- A** Boston / Spice / Marvel / Swing / Cotton / Tessuto cliente minimo 4 pz.  
*Customer fabric, min. 4 pcs - Tissue client minimum 4 articles*
- B** Cachemire / Daytona / Econabuk / Sogno / Ecopelle Vintage *Vintage eco-leather - Éco-cuir Vintage*  
 Pelle cliente minimo 4 pz. *Min. 4 pcs must be ordered with customer's leather - Pour cuir du client, minimum 4 articles.*
- F** Pelle Polo

\* Non disponibile in Texplast  
*Not available in Texplast*  
 Non disponible en Texplast

	cod.	Cat. 1/ONE	Cat. A	Cat. B	Cat. F
--	------	------------	--------	--------	--------

## Elena - L 50 P 56 H 85/47



**Struttura metallo**  
*Metal frame - Structure métal:*

Opaco bianco gesso - Opaco antracite - Fango  
*Matt Chalk White - Matt Anthracite - Mud*  
 Blanc craie Mat - Anthracite Mat - Boue

ELEMET

260  
\*

268

288

435

▲ **Maggiorazione per finitura metallo optional**  
*Surcharge for optional metal finish* + 60  
 Supplément pour finition métal optionnelle

Per imballo/ordine 1 pz.  
*For 1-piece package/order - Pour emballage/commande 1 chaise* + 20



**N.B.: Piedino con feltro NON applicabile**

*N.B.: Felt-padded foot NOT available - N.B.: Pied avec patin feutre NON utilisable*

Kg 6,3 | M<sup>3</sup> 0,42 | Tessuto/*Fabric*/Tissu ml. 1 - pelle/*leather*/cuir m<sup>2</sup> 2

## Eva - L 41 P 60 H 85/45



**Struttura metallo**  
*Metal frame - Structure métal:*

Opaco bianco gesso - Opaco antracite - Fango  
*Matt Chalk White - Matt Anthracite - Mud*  
 Blanc craie Mat - Anthracite Mat - Boue

EVAMET

237

-

-

-

Per imballo/ordine 1 pz.  
*For 1-piece package/order - Pour emballage/commande 1 chaise* + 20



Solo Texplast  
*Only Texplast*  
 Uniquement  
 Texplast

**N.B.: Piedino con feltro NON applicabile**

*N.B.: Felt-padded foot NOT available - N.B.: Pied avec patin feutre NON utilisable*

Kg 4,4 | M<sup>3</sup> 0,42

## Gaia - L 43 P 53 H 94/48



**Struttura metallo**  
*Metal frame - Structure métal:*

Opaco bianco gesso - Opaco antracite - Fango  
*Matt Chalk White - Matt Anthracite - Mud*  
 Blanc craie Mat - Anthracite Mat - Boue

GAIMET

218  
\*

226

248

401

▲ **Maggiorazione per finitura metallo optional**  
*Surcharge for optional metal finish* + 60  
 Supplément pour finition métal optionnelle

Per imballo/ordine 1 pz.  
*For 1-piece package/order - Pour emballage/commande 1 chaise* + 20



**N.B.: Piedino con feltro NON applicabile**

*N.B.: Felt-padded foot NOT available - N.B.: Pied avec patin feutre NON utilisable*

Kg 5,8 | M<sup>3</sup> 0,42 | Tessuto/*Fabric*/Tissu ml. 0,9 - pelle/*leather*/cuir m<sup>2</sup> 1,46

## Havana - L 56 P 58 H 88/47



**Struttura metallo**  
*Metal frame - Structure métal:*

Opaco bianco gesso - Opaco antracite - Fango  
*Matt Chalk White - Matt Anthracite - Mud*  
 Blanc craie Mat - Anthracite Mat - Boue

HAVMET

323  
\*

350

376

525

▲ **Maggiorazione per finitura metallo optional**  
*Surcharge for optional metal finish* + 60  
 Supplément pour finition métal optionnelle

Per imballo/ordine 1 pz.  
*For 1-piece package/order - Pour emballage/commande 1 chaise* + 20



**N.B.: Piedino con feltro opzionale**

*N.B.: Optional felt-padded foot - N.B.: Option pied avec patin feutre*

Kg 9 | M<sup>3</sup> 0,49 | Tessuto/*Fabric*/Tissu ml. 1,7 - pelle/*leather*/cuir m<sup>2</sup> 2,2

# Sedie / Chairs / Chaises

▲ N.B. Finiture pag. 90

N.B.: Finishes page 90

N.B.: Finitions page 90

**1/One** Amsterdam / Bora / Dublin / Easy / Maracaibo / Nairobi / Texplast / Ecopelle Twist *Twist eco-leather - Éco-cuir Twist*

**A** Boston / Spice / Marvel / Swing / Cotton / Tessuto cliente minimo 4 pz.

*Customer fabric, min. 4 pcs - Tissu client minimum 4 articles*

**B** Cachemire / Daytona / Econabuk / Sogno / Ecopelle Vintage *Vintage eco-leather - Éco-cuir Vintage*

*Pelle cliente minimo 4 pz. Min. 4 pcs must be ordered with customer's leather - Pour cuir du client, minimum 4 articles.*

**F** Pelle Polo

\* Non disponibile in Texplast

*Not available in Texplast*

Non disponible en Texplast

	cod.	Cat. 1/ONE	Cat. A	Cat. B	Cat. F
--	------	------------	--------	--------	--------

## Home - L 47 P 56 H 91/47



### Struttura metallo

*Metal frame - Structure métal:*

Opaco bianco gesso - Opaco antracite - Fango

*Matt Chalk White - Matt Anthracite - Mud*

Blanc craie Mat - Anthracite Mat - Boue

▲ **Maggiorazione per finitura metallo optional**

*Surcharge for optional metal finish*

**+ 60**

*Supplément pour finition métal optionnelle*

Per imballo/ordine 1 pz.

*For 1-piece package/order - Pour emballage/commande 1 chaise*

**+ 20**



**N.B.: Piedino con feltro NON applicabile**

*N.B.: Felt-padded foot NOT available - N.B.: Pied avec patin feutre NON utilisable*

Kg 7,5 | M<sup>3</sup> 0,47 | Tessuto/Fabric/Tissu ml. 1 - pelle/leather/cuir m<sup>2</sup> 1,9

## Lea - L 49 P 53 H 83/46



### Struttura polipropilene opaco

*Matt polypropylene frame - Structure en polypropylène mat*

**Imballo 4 pz.**

*4 pcs in each package*

Emballage 4 articles

Bianco gesso - Antracite - Madreperla - Carta da zucchero

*Matt Chalk White - Matt Anthracite - Mother-Of-Pearl - Blue-Grey*

Blanc craie - Anthracite - Nacre - Bleu ciel

LEAPOL

**85**

€ cad.

-

-

-

-

**Imballo 2 pz.**

*2 pcs in each package*

Emballage 2 articles.

Bianco gesso - Antracite - Madreperla - Carta da zucchero

*Matt Chalk White - Matt Anthracite - Mother-Of-Pearl - Blue-Grey*

Blanc craie - Anthracite - Nacre - Bleu ciel

LEAPOL

**104**

€ cad.

-

-

-

-

**N.B.: Piedino con feltro NON applicabile**

*N.B.: Felt-padded foot NOT available - N.B.: Pied avec patin feutre NON utilisable*

**Minimo 4 pezzi per colore e successivi multipli di 2**

*min. 4 pieces of each colour and subsequent multiples of 2*

*minimum 4 articles par couleur et multiples de 2 pour plus de 4*



Kg 2,9 | M<sup>3</sup> 0,28 (4 pz.) - Kg 2,90 | M<sup>3</sup> 0,25 (2 pz.)

## Lilium - L 48 P 58 H 74/47



### Struttura metallo

*Metal frame - Structure métal:*

Opaco bianco gesso - Opaco antracite - Fango

*Matt Chalk White - Matt Anthracite - Mud*

Blanc craie Mat - Anthracite Mat - Boue

▲ **Maggiorazione per finitura metallo optional**

*Surcharge for optional metal finish*

**+ 60**

*Supplément pour finition métal optionnelle*

Per imballo/ordine 1 pz.

*For 1-piece package/order - Pour emballage/commande 1 chaise*

**+ 20**



**N.B.: Piedino con feltro NON applicabile**

*N.B.: Felt-padded foot NOT available - N.B.: Pied avec patin feutre NON utilisable*

Kg 6,3 | M<sup>3</sup> 0,42 | Tessuto/Fabric/Tissu ml. 1,5 - pelle/leather/cuir m<sup>2</sup> 2,2

## Lula - L 48 P 50 H 82/46



### Struttura legno

*Wooden frame - Structure bois:*

Frassino tinto (naturale, carbone, termocotto, moka, sabbia)

*Ash stained (Natural, Coal, Heat-treated, Mocha, Sand)*

Hêtre teinté (nature, charbon, thermo-traité, moka, sable)

LULFRA

**438**

\*

**460**

**480**

**651**

Per imballo/ordine 1 pz.

*For 1-piece package/order - Pour emballage/commande 1 chaise*

**+ 20**



**N.B.: Piedino con feltro NON applicabile**

*N.B.: Felt-padded foot NOT available - N.B.: Pied avec patin feutre NON utilisable*

Kg 7,2 | M<sup>3</sup> 0,35 | Tessuto/Fabric/Tissu ml. 1,5 - pelle/leather/cuir m<sup>2</sup> 1,7

# Sedie / Chairs / Chaises

▲ N.B. Finiture pag. 90

N.B.: Finishes page 90

N.B.: Finitions page 90

**1/One** Amsterdam / Bora / Dublin / Easy / Maracaibo / Nairobi / Texplast / Ecopelle Twist *Twist eco-leather - Éco-cuir Twist*

**A** Boston / Spice / Marvel / Swing / Cotton / Tessuto cliente minimo 4 pz.

*Customer fabric, min. 4 pcs - Tissu client minimum 4 articles*

**B** Cachemire / Daytona / Econabuk / Sogno / Ecopelle Vintage *Vintage eco-leather - Éco-cuir Vintage*

*Pelle cliente minimo 4 pz. Min. 4 pcs must be ordered with customer's leather - Pour cuir du client, minimum 4 articles.*

**F** Pelle Polo

\* Non disponibile in Texplast

*Not available in Texplast*

*Non disponible en Texplast*

	cod.	Cat. 1/ONE	Cat. A	Cat. B	Cat. F
--	------	------------	--------	--------	--------

## Luna - L 47 P 59 H 91/48



**N.B.: Piedino con feltro NON applicabile**

*N.B.: Felt-padded foot NOT available - N.B.: Pied avec patin feutre NON utilisable*

Kg 6,5 | M<sup>3</sup> 0,47 | Tessuto/Fabric/Tissu ml. 1 - pelle/leather/cuir m<sup>2</sup> 2

### Struttura metallo

*Metal frame - Structure métal:*

Opaco bianco gesso - Opaco antracite - Fango

*Matt Chalk White - Matt Anthracite - Mud*

Blanc craie Mat - Anthracite Mat - Boue

LUNMET

352

366

394

544

▲ **Maggiorazione per finitura metallo optional**

*Surcharge for optional metal finish*

**+ 60**

Supplément pour finition métal optionnelle

Per imballo/ordine 1 pz.

*For 1-piece package/order - Pour emballage/commande 1 chaise*

**+ 20**



## Megan - L 46 P 54 H 92/48



**N.B.: Piedino con feltro NON applicabile**

*N.B.: Felt-padded foot NOT available - N.B.: Pied avec patin feutre NON utilisable*

Kg 7,1 | M<sup>3</sup> 0,42 | Tessuto/Fabric/Tissu ml. 1,5 - pelle/leather/cuir m<sup>2</sup> 2,2

### Struttura metallo

*Metal frame - Structure métal:*

Opaco bianco gesso - Opaco antracite - Fango

*Matt Chalk White - Matt Anthracite - Mud*

Blanc craie Mat - Anthracite Mat - Boue

MEGMET

483

412

437

608

▲ **Maggiorazione per finitura metallo optional**

*Surcharge for optional metal finish*

**+ 60**

Supplément pour finition métal optionnelle

Per imballo/ordine 1 pz.

*For 1-piece package/order - Pour emballage/commande 1 chaise*

**+ 20**



## Moon - L 46 P 55 H 90/48



**N.B.: Piedino con feltro NON applicabile**

*N.B.: Felt-padded foot NOT available - N.B.: Pied avec patin feutre NON utilisable*

Kg 7,4 | M<sup>3</sup> 0,42 | Tessuto/Fabric/Tissu ml. 1,4 - pelle/leather/cuir m<sup>2</sup> 1,8

### Struttura metallo

*Metal frame - Structure métal:*

Opaco bianco gesso - Opaco antracite - Fango

*Matt Chalk White - Matt Anthracite - Mud*

Blanc craie Mat - Anthracite Mat - Boue

MOOMET

483

412

437

608

▲ **Maggiorazione per finitura metallo optional**

*Surcharge for optional metal finish*

**+ 60**

Supplément pour finition métal optionnelle

Per imballo/ordine 1 pz.

*For 1-piece package/order - Pour emballage/commande 1 chaise*

**+ 20**



## Nora - L 47 P 57 H 92/47



**N.B.: Piedino con feltro NON applicabile**

*N.B.: Felt-padded foot NOT available - N.B.: Pied avec patin feutre NON utilisable*

Kg 6,2 | M<sup>3</sup> 0,42 | Tessuto/Fabric/Tissu ml. 1,4 - pelle/leather/cuir m<sup>2</sup> 2,6

### Struttura metallo

*Metal frame - Structure métal:*

Opaco bianco gesso - Opaco antracite - Fango

*Matt Chalk White - Matt Anthracite - Mud*

Blanc craie Mat - Anthracite Mat - Boue

NORMET

365

378

413

641

▲ **Maggiorazione per finitura metallo optional**

*Surcharge for optional metal finish*

**+ 60**

Supplément pour finition métal optionnelle

Per imballo/ordine 1 pz.

*For 1-piece package/order - Pour emballage/commande 1 chaise*

**+ 20**



No Easy  
No Easy  
No Easy

**1/One** Amsterdam / Bora / Dublin / Easy / Maracaibo / Nairobi / Texplast / Ecopelle Twist *Twist eco-leather - Éco-cuir Twist*

**A** Boston / Spice / Marvel / Swing / Cotton / Tessuto cliente minimo 4 pz.

*Customer fabric, min. 4 pcs - Tissu client minimum 4 articles*

**B** Cachemire / Daytona / Econabuk / Sogno / Ecopelle Vintage *Vintage eco-leather - Éco-cuir Vintage*

*Pelle cliente minimo 4 pz. Min. 4 pcs must be ordered with customer's leather - Pour cuir du client, minimum 4 articles.*

**F** Pelle Polo

\* Non disponibile in Texplast

*Not available in Texplast*

Non disponible en Texplast

	cod.	Cat. 1/ONE	Cat. A	Cat. B	Cat. F
--	------	------------	--------	--------	--------

## Ofra - L 45 P 53 H 78/47



### Struttura metallo

*Metal frame - Structure métal:*

Opaco bianco gesso - Opaco antracite - Fango

*Matt Chalk White - Matt Anthracite - Mud*

Blanc craie Mat - Anthracite Mat - Boue

OFRMET

263

\*

271

290

428

▲ Maggiorazione per finitura metallo optional

*Surcharge for optional metal finish*

Supplément pour finition métal optionnelle

+ 60

Per imballo/ordine 1 pz.

*For 1-piece package/order - Pour emballage/commande 1 chaise*

+ 20



**N.B.: Piedino con feltro opzionale**

*N.B.: Optional felt-padded foot - N.B.: Option pied avec patin feutre*

Kg 6,8 | M<sup>3</sup> 0,42 | Tessuto/Fabric/Tissu ml. 1 - pelle/leather/cuir m<sup>2</sup> 1,5

## Paris - L 51 P 57 H 86/48



### Struttura metallo

*Metal frame - Structure métal:*

Opaco bianco gesso - Opaco antracite - Fango

*Matt Chalk White - Matt Anthracite - Mud*

Blanc craie Mat - Anthracite Mat - Boue

PARMET

381

\*

403

422

596

▲ Maggiorazione per finitura metallo optional

*Surcharge for optional metal finish*

Supplément pour finition métal optionnelle

+ 60

Per imballo/ordine 1 pz.

*For 1-piece package/order - Pour emballage/commande 1 chaise*

+ 20



**N.B.: Sedia fornita smontata - N.B.: Piedino con feltro opzionale**

*N.B.: Chair supplied unassembled - N.B.: Optional felt-padded foot - N.B.: Chaise fournie démontée - N.B.: Pied avec patin feutre optionnel feutre*

Kg 7,9 | M<sup>3</sup> 0,24 | Tessuto/Fabric/Tissu ml. 1,1 - pelle/leather/cuir m<sup>2</sup> 2,2

## Paris Bicolor - L 51 P 57 H 86/48



**Tessuto A**  
Fabric A  
Tissu A

**Tessuto B**  
Fabric B  
Tissu B

### Struttura metallo

*Metal frame - Structure métal:*

Opaco bianco gesso - Opaco antracite - Fango

*Matt Chalk White - Matt Anthracite - Mud*

Blanc craie Mat - Anthracite Mat - Boue

PARBCK

403

\*

425

444

618

▲ Maggiorazione per finitura metallo optional

*Surcharge for optional metal finish*

Supplément pour finition métal optionnelle

+ 60

Per imballo/ordine 1 pz.

*For 1-piece package/order - Pour emballage/commande 1 chaise*

+ 20



**N.B.: Sedia fornita smontata - N.B.: Piedino con feltro opzionale**

*N.B.: Chair supplied unassembled - N.B.: Optional felt-padded foot - N.B.: Chaise fournie démontée - N.B.: Pied avec patin feutre optionnel feutre*

Kg 7,5 | M<sup>3</sup> 0,24 | Tessuto/Fabric/Tissu ml. 1,3 - pelle/leather/cuir m<sup>2</sup> 2,2

## Roxy - L 49 P 63 H 85/47



### Struttura metallo

*Metal frame - Structure métal:*

Opaco bianco gesso - Opaco antracite - Fango

*Matt Chalk White - Matt Anthracite - Mud*

Blanc craie Mat - Anthracite Mat - Boue

ROXMET

329

\*

340

365

535

▲ Maggiorazione per finitura metallo optional

*Surcharge for optional metal finish*

Supplément pour finition métal optionnelle

+ 60

Per imballo/ordine 1 pz.

*For 1-piece package/order - Pour emballage/commande 1 chaise*

+ 20



**N.B.: Piedino con feltro NON applicabile**

*N.B.: Felt-padded foot NOT available - N.B.: Pied avec patin feutre NON utilisable*

Kg 6,9 | M<sup>3</sup> 0,46 | Tessuto/Fabric/Tissu ml. 1,1

No Easy  
No Easy  
No Easy

# Sedie / Chairs / Chaises

▲ N.B. Finiture pag. 90

N.B.: Finishes page 90

N.B.: Finitions page 90

1/One Amsterdam / Bora / Dublin / Easy / Maracaibo / Nairobi / Texplast / Ecopelle Twist *Twist eco-leather* - Éco-cuir Twist

A Boston / Spice / Marvel / Swing / Cotton / Tessuto cliente minimo 4 pz.

Customer fabric, min. 4 pcs - Tissu client minimum 4 articles

B Cachemire / Daytona / Econabuk / Sogno / Ecopelle Vintage *Vintage eco-leather* - Éco-cuir Vintage

Pelle cliente minimo 4 pz. Min. 4 pcs must be ordered with customer's leather - Pour cuir du client, minimum 4 articles.

F Pelle Polo

\* Non disponibile in Texplast

Not available in Texplast

Non disponible en Texplast

	cod.	Cat. 1/ONE	Cat. A	Cat. B	Cat. F
--	------	------------	--------	--------	--------

## Sara - L 46 P 55 H 84/47,5



N.B.: Piedino con feltro NON applicabile

N.B.: Felt-padded foot NOT available - N.B.: Pied avec patin feutre NON utilisable

Kg 6,5 | M<sup>3</sup> 0,42 | Tessuto/Fabric/Tissu ml. 1,10 - pelle/leather/cuir m<sup>2</sup> 1,45

### Struttura metallo

Metal frame- Structure métal:

Opaco bianco gesso - Opaco antracite - Fango

Matt Chalk White - Matt Anthracite - Mud

Blanc craie Mat - Anthracite Mat - Boue

SARMET

219

234

252

373

▲ Maggiorazione per finitura metallo optional

Surcharge for optional metal finish

+ 60

Supplément pour finition métal optionnelle

Per imballo/ordine 1 pz.

For 1-piece package/order - Pour emballage/commande 1 chaise

+ 20



## Sofia - L 49 P 55 H 84/47



N.B.: Piedino con feltro opzionale

N.B.: Optional felt-padded foot - N.B.: Option pied avec patin feutre

Kg 7,7 | M<sup>3</sup> 0,42 | Tessuto/Fabric/Tissu ml. 1,6 - pelle/leather/cuir m<sup>2</sup> 2,2

### Struttura metallo

Metal frame- Structure métal:

Opaco bianco gesso - Opaco antracite - Fango

Matt Chalk White - Matt Anthracite - Mud

Blanc craie Mat - Anthracite Mat - Boue

SOFMET

326

343

376

589

▲ Maggiorazione per finitura metallo optional

Surcharge for optional metal finish

+ 60

Supplément pour finition métal optionnelle

Per imballo/ordine 1 pz.

For 1-piece package/order - Pour emballage/commande 1 chaise

+ 20



## Tequila - L 48 P 57 H 89/47



N.B.: Piedino con feltro opzionale

N.B.: Optional felt-padded foot - N.B.: Option pied avec patin feutre

Kg 7,7 | M<sup>3</sup> 0,48 | Tessuto/Fabric/Tissu ml. 1,6 - pelle/leather/cuir m<sup>2</sup> 2,2

### Struttura metallo

Metal frame- Structure métal:

Opaco bianco gesso - Opaco antracite - Fango

Matt Chalk White - Matt Anthracite - Mud

Blanc craie Mat - Anthracite Mat - Boue

TEQMET

328

343

379

614

▲ Maggiorazione per finitura metallo optional

Surcharge for optional metal finish

+ 60

Supplément pour finition métal optionnelle

Per imballo/ordine 1 pz.

For 1-piece package/order - Pour emballage/commande 1 chaise

+ 20



No tessuto Daytona  
Daytona fabric not available  
Sauf tissu Daytona

## Twist - L 50 P 63 H 89/47



N.B.: Piedino con feltro NON applicabile

N.B.: Felt-padded foot NOT available - N.B.: Pied avec patin feutre NON utilisable

Kg 6,5 | M<sup>3</sup> 0,47 | Tessuto/Fabric/Tissu ml. 1 - pelle/leather/cuir m<sup>2</sup> 2

### Struttura metallo

Metal frame- Structure métal:

Opaco bianco gesso - Opaco antracite - Fango

Matt Chalk White - Matt Anthracite - Mud

Blanc craie Mat - Anthracite Mat - Boue

TWIMET

384

394

418

589

▲ Maggiorazione per finitura metallo optional

Surcharge for optional metal finish

+ 60

Supplément pour finition métal optionnelle

Per imballo/ordine 1 pz.

For 1-piece package/order - Pour emballage/commande 1 chaise

+ 20



No Econabuk  
No Eco-nubuck  
No Econabuk

**1/One** Amsterdam / Bora / Dublin / Easy / Maracaibo / Nairobi / Texplast / Ecopelle Twist *Twist eco-leather - Éco-cuir Twist*

**A** Boston / Spice / Marvel / Swing / Cotton / Tessuto cliente minimo 4 pz.

*Customer fabric, min. 4 pcs - Tissu client minimum 4 articles*

**B** Cachemire / Daytona / Econabuk / Sogno / Ecopelle Vintage *Vintage eco-leather - Éco-cuir Vintage*

*Pelle cliente minimo 4 pz. Min. 4 pcs must be ordered with customer's leather - Pour cuir du client, minimum 4 articles.*

**F** Pelle Polo

\* Non disponibile in Texplast

*Not available in Texplast*

Non disponible en Texplast

	cod.	Cat. 1/ONE	Cat. A	Cat. B	Cat. F
--	------	------------	--------	--------	--------

## Vittoria - L 44 P 58 H 84/47



### Struttura metallo

*Metal frame - Structure métal:*

Opaco bianco gesso - Opaco antracite - Fango

*Matt Chalk White - Matt Anthracite - Mud*

Blanc craie Mat - Anthracite Mat - Boue

VITMET

390  
\*

409

433

601

▲ **Maggiorazione per finitura metallo optional**

*Surcharge for optional metal finish*

**+ 60**

*Supplément pour finition métal optionnelle*

Per imballo/ordine 1 pz.

*For 1-piece package/order - Pour emballage/commande 1 chaise*

**+ 20**



**N.B.: Piedino con feltro opzionale**

*N.B.: Optional felt-padded foot - N.B.: Option pied avec patin feutre*

Kg 6,4 | M<sup>3</sup> 0,42 | Tessuto/Fabric/Tissu ml. 1 - pelle/leather/cuir m<sup>2</sup> 2

## Zenda - L 47 P 57 H 84/47



### Struttura metallo

*Metal frame - Structure métal:*

Opaco bianco gesso - Opaco antracite - Fango

*Matt Chalk White - Matt Anthracite - Mud*

Blanc craie Mat - Anthracite Mat - Boue

ZENMET

274  
\*

285

308

451

▲ **Maggiorazione per finitura metallo optional**

*Surcharge for optional metal finish*

**+ 60**

*Supplément pour finition métal optionnelle*

Per imballo/ordine 1 pz.

*For 1-piece package/order - Pour emballage/commande 1 chaise*

**+ 20**



**N.B.: Piedino con feltro NON applicabile**

*N.B.: Felt-padded foot NOT available - N.B.: Pied avec patin feutre NON utilisable*

Kg 7,3 | M<sup>3</sup> 0,42 | Tessuto/Fabric/Tissu ml. 1,2 - pelle/leather/cuir m<sup>2</sup> 2,2

## Piedino con feltro optional - *Optional felt-padded foot - Option pied avec patin feutre*



### Set 4 piedini

*Set of 4 feet*

**€ 6**

*Ensemble 4 pieds*

# Poltroncine / Armchairs / Petits fauteuils

▲ N.B. Finiture pag. 90

N.B.: Finishes page 90

N.B.: Finitions page 90

**1/One** Amsterdam / Bora / Dublin / Easy / Maracaibo / Nairobi / Texplast / Ecopelle Twist *Twist eco-leather* - Éco-cuir Twist

**A** Boston / Spice / Marvel / Swing / Cotton / Tessuto cliente minimo 4 pz.

*Customer fabric, min. 4 pcs - Tissu client minimum 4 articles*

**B** Cachemire / Daytona / Econabuk / Sogno / Ecopelle Vintage *Vintage eco-leather* - Éco-cuir Vintage

*Pelle cliente minimo 4 pz. Min. 4 pcs must be ordered with customer's leather - Pour cuir du client, minimum 4 articles.*

**F** Pelle Polo

\* Non disponibile in Texplast

*Not available in Texplast*

Non disponible en Texplast

	cod.	Cat. 1/ONE	Cat. A	Cat. B	Cat. F
--	------	------------	--------	--------	--------

## Arisa - L 58 P 61 H 82/47



### Struttura metallo

*Metal frame - Structure métal:*

Opaco bianco gesso - Opaco antracite - Fango  
*Matt Chalk White - Matt Anthracite - Mud*  
 Blanc craie Mat - Anthracite Mat - Boue

PARIMET

522  
\*

534

567

781

▲ Maggiorazione per finitura metallo optional  
*Surcharge for optional metal finish*  
 Supplément pour finition métal optionnelle **+ 90**

**N.B.: Poltroncina fornita smontata - N.B.: Piedino con feltro opzionale**

*N.B.: Armchair supplied unassembled - N.B.: Optional felt-padded foot - N.B.: Fauteuil fournie démontée - N.B.: Pied avec patin feutre optionnel/feutre*



Kg 8,3 | M<sup>3</sup> 0,31 | Tessuto/Fabric/Tissu ml. 1,3 - pelle/leather/cuir m<sup>2</sup> 2,8

## Arisa bicolore - L 58 P 61 H 82/47



**Tessuto A**  
*Fabric A*  
 Tissu A

**Tessuto B**  
*Fabric B*  
 Tissu B

### Struttura metallo

*Metal frame - Structure métal:*

Opaco bianco gesso - Opaco antracite - Fango  
*Matt Chalk White - Matt Anthracite - Mud*  
 Blanc craie Mat - Anthracite Mat - Boue

PARIBCK

544  
\*

556

589

803

▲ Maggiorazione per finitura metallo optional  
*Surcharge for optional metal finish*  
 Supplément pour finition métal optionnelle **+ 90**

Per finiture miste seduta/schienale e scocca fare riferimento alla fascia di prezzo più alta tra le due varianti scelte  
*For mixed seat/back and frame finishes please refer to the highest price category of the two versions chosen*

Pour des finitions mixtes pour l'assise/dossier et la coque, se référer à la catégorie de prix la plus haute entre les deux variantes choisies

**N.B.: Poltroncina fornita smontata - N.B.: Piedino con feltro opzionale**

*N.B.: Armchair supplied unassembled - Optional felt-padded foot - N.B.: Fauteuil fournie démontée - Pied avec patin feutre optionnel/feutre*



Kg 8,3 | M<sup>3</sup> 0,31 | Tessuto/Fabric/Tissu ml. 1,3 - pelle/leather/cuir m<sup>2</sup> 2,8

## Chicco - L 58 P 60 H 83/49



### Struttura metallo

*Metal frame - Structure métal:*

Opaco bianco gesso - Opaco antracite - Fango  
*Matt Chalk White - Matt Anthracite - Mud*  
 Blanc craie Mat - Anthracite Mat - Boue

PCHIMET

427  
\*

443

486

754  
\*

▲ Maggiorazione per finitura metallo optional  
*Surcharge for optional metal finish*  
 Supplément pour finition métal optionnelle **+ 90**

**N.B.: Piedino con feltro NON applicabile**

*N.B.: Felt-padded foot NOT available - N.B.: Pied avec patin feutre NON utilisable*



Kg 8,7 | M<sup>3</sup> 0,31 | Tessuto/Fabric/Tissu ml. 1,8 - pelle/leather/cuir m<sup>2</sup> 2,8

## Carol - L 58 P 57 H 82/47



### Struttura metallo

*Metal frame - Structure métal:*

Opaco bianco gesso - Opaco antracite - Fango  
*Matt Chalk White - Matt Anthracite - Mud*  
 Blanc craie Mat - Anthracite Mat - Boue

PCARMET

511  
\*

524

563

807  
\*

▲ Maggiorazione per finitura metallo optional  
*Surcharge for optional metal finish*  
 Supplément pour finition métal optionnelle **+ 90**

**N.B.: Poltroncina fornita smontata - N.B.: Piedino con feltro NON applicabile**

*N.B.: Armchair supplied unassembled - N.B.: Felt-padded foot NOT available - N.B.: Fauteuil fourni démonté - N.B.: Pied avec patin feutre NON utilisable*



Kg 8 | M<sup>3</sup> 0,31 | Tessuto/Fabric/Tissu ml. 1,9 - pelle/leather/cuir m<sup>2</sup> 3

# Poltroncine / Armchairs / Petits fauteuils

▲ N.B. Finiture pag. 90

N.B.: Finishes page 90

N.B.: Finitions page 90

**1/One** Amsterdam / Bora / Dublin / Easy / Maracaibo / Nairobi / Texplast / Ecopelle Twist *Twist eco-leather - Éco-cuir Twist*

**A** Boston / Spice / Marvel / Swing / Cotton / Tessuto cliente minimo 4 pz.

*Customer fabric, min. 4 pcs - Tissu client minimum 4 articles*

**B** Cachemire / Daytona / Econabuk / Sogno / Ecopelle Vintage *Vintage eco-leather - Éco-cuir Vintage*

*Pelle cliente minimo 4 pz. Min. 4 pcs must be ordered with customer's leather - Pour cuir du client, minimum 4 articles.*

**F** Pelle Polo

\* Non disponibile in Texplast

*Not available in Texplast*

Non disponible en Texplast

	cod.	Cat. 1/ONE	Cat. A	Cat. B	Cat. F
--	------	------------	--------	--------	--------

## Lilium - L 58 P 57 H 83/47

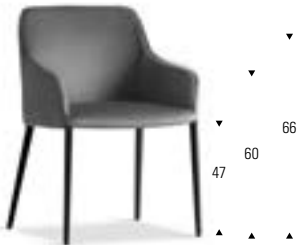

### Struttura metallo

*Metal frame - Structure métal:*

Opaco bianco gesso - Opaco antracite - Fango  
*Matt Chalk White - Matt Anthracite - Mud*  
 Blanc craie Mat - Anthracite Mat - Boue

▲ **Maggiorazione per finitura metallo optional**  
*Surcharge for optional metal finish*  
 Supplément pour finition métal optionnelle **+ 90**



**N.B.: Piedino con feltro NON applicabile**

*N.B.: Felt-padded foot NOT available - N.B.: Pied avec patin feutre NON utilisable*

Kg 6,4 | M³ 0,31 | Tessuto/Fabric/Tissu ml. 1,7 - pelle/leather/cuir m² 3,3

	PLILMET	429*	446	489	763
				No tessuto Daytona <i>Daytona fabric not available</i> Sauf tissu Daytona	

## Paris - L 57 P 60 H 81/47



### Struttura metallo

*Metal frame - Structure métal:*

Opaco bianco gesso - Opaco antracite - Fango  
*Matt Chalk White - Matt Anthracite - Mud*  
 Blanc craie Mat - Anthracite Mat - Boue

▲ **Maggiorazione per finitura metallo optional**  
*Surcharge for optional metal finish*  
 Supplément pour finition métal optionnelle **+ 90**



**N.B.: Poltroncina fornita smontata - N.B.: Piedino con feltro opzionale**

*N.B.: Armchair supplied unassembled - N.B.: Optional felt-padded foot - N.B.: Fauteuil fournie démontée - N.B.: Pied avec patin feutre optionneffeutre*

Kg 7,5 | M³ 0,31 | Tessuto/Fabric/Tissu ml. 1,6 - pelle/leather/cuir m² 2,6

	PPARMET	523*	535	566	781
--	---------	------	-----	-----	-----

## Paris bicolor - L 57 P 60 H 81/47



**Tessuto A**  
*Fabric A*  
 Tissu A

**Tessuto B**  
*Fabric B*  
 Tissu B

### Struttura metallo

*Metal frame - Structure métal:*

Opaco bianco gesso - Opaco antracite - Fango  
*Matt Chalk White - Matt Anthracite - Mud*  
 Blanc craie Mat - Anthracite Mat - Boue

▲ **Maggiorazione per finitura metallo optional**  
*Surcharge for optional metal finish*  
 Supplément pour finition métal optionnelle **+ 90**



**N.B.: Poltroncina fornita smontata - N.B.: Piedino con feltro opzionale**

*N.B.: Armchair supplied unassembled - Optional felt-padded foot - N.B.: Fauteuil fournie démontée - Pied avec patin feutre optionneffeutre*

Kg 7,5 | M³ 0,031 | Tessuto/Fabric/Tissu ml. 1,6 - pelle/leather/cuir m² 2,6

	PPARBCK	545*	557	588	803
				Per finiture miste seduta/schienale e scocca fare riferimento alla fascia di prezzo più alta tra le due varianti scelte <i>For mixed seat/back and frame finishes please refer to the highest price category of the two versions chosen</i> Pour des finitions mixtes pour l'assise/dossier et la coque, se référer à la catégorie de prix la plus haute entre les deux variantes choisies	

## Sofia - L 58 P 60 H 82/48

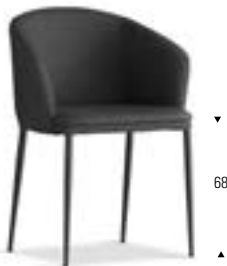

### Struttura metallo

*Metal frame - Structure métal:*

Opaco bianco gesso - Opaco antracite - Fango  
*Matt Chalk White - Matt Anthracite - Mud*  
 Blanc craie Mat - Anthracite Mat - Boue

▲ **Maggiorazione per finitura metallo optional**  
*Surcharge for optional metal finish*  
 Supplément pour finition métal optionnelle **+ 90**



**N.B.: Piedino con feltro opzionale**

*N.B.: Optional felt-padded foot - N.B.: Option pied avec patin feutre*

Kg 7,5 | M³ 0,31 | Tessuto/Fabric/Tissu ml. 2 - pelle/leather/cuir m² 2,90

	PSOFMET	412*	438	472	776
--	---------	------	-----	-----	-----



# Poltroncine / Armchairs / Petits fauteuils

▲ **N.B. Finiture pag. 90**

N.B.: Finishes page 90

N.B.: Finitions page 90

**1/One** Amsterdam / Bora / Dublin / Easy / Maracaibo / Nairobi / Texplast / Ecopelle Twist *Twist eco-leather - Éco-cuir Twist*

**A** Boston / Spice / Marvel / Swing / Cotton / Tessuto cliente minimo 4 pz.

*Customer fabric, min. 4 pcs - Tissu client minimum 4 articles*

**B** Cachemire / Daytona / Econabuk / Sogno / Ecopelle Vintage *Vintage eco-leather - Éco-cuir Vintage*

*Pelle cliente minimo 4 pz. Min. 4 pcs must be ordered with customer's leather - Pour cuir du client, minimum 4 articles.*

**F** Pelle Polo

\* Non disponibile in Texplast

*Not available in Texplast*

Non disponible en Texplast

cod.

Cat. 1/ONE

Cat. A

Cat. B

Cat. F

## Piedino con feltro optional - *Optional felt-padded foot* - Option pied avec patin feutre



**Set 4 piedini**

*Set of 4 feet*

€ 6

Ensemble 4 pieds

	cod.	Cat. 1/ONE	Cat. A	Cat. B	Cat. F

1/One Amsterdam / Bora / Dublin / Easy / Maracaibo / Nairobi / Texplast / Ecopelle Twist *Twist eco-leather* - Éco-cuir Twist

A Boston / Spice / Marvel / Swing / Cotton / Tessuto cliente minimo 4 pz.

Customer fabric, min. 4 pcs - Tissu client minimum 4 articles

B Cachemire / Daytona / Econabuk / Sogno / Ecopelle Vintage *Vintage eco-leather* - Éco-cuir Vintage

Pelle cliente minimo 4 pz. Min. 4 pcs must be ordered with customer's leather - Pour cuir du client, minimum 4 articles.

F Pelle Polo

\* Non disponibile in Texplast

Not available in Texplast

Non disponible en Texplast

	cod.	Cat. 1/ONE	Cat. A	Cat. B	Cat. F
--	------	------------	--------	--------	--------

## Arisa - L 51 P 57 H 96/65



### Struttura metallo

Metal frame - Structure métal:

Opaco bianco gesso - Opaco antracite - Fango  
 Matt Chalk White - Matt Anthracite - Mud  
 Blanc craie Mat - Anthracite Mat - Boue

▲ Maggiorazione per finitura metallo optional  
 Surcharge for optional metal finish  
 Supplément pour finition métal optionnelle **+ 85**

SARIMET

467  
\*

477

502

676

N.B.: Piedino con feltro opzionale

N.B.: Optional felt-padded foot - N.B.: Option pied avec patin feutre



Kg 8,9 | M<sup>3</sup> 0,30 | Tessuto/Fabric/Tissu ml. 1,3 - pelle/leather/cuir m<sup>2</sup> 1,9

Non disponibili tessuti Easy

The Easy fabrics are not available

Tissus Easy non disponibles

## Arisa bicolore - L 51 P 57 H 96/65



 **Tessuto A**  
Fabric A  
Tissu A

 **Tessuto B**  
Fabric B  
Tissu B

### Struttura metallo

Metal frame - Structure métal:

Opaco bianco gesso - Opaco antracite - Fango  
 Matt Chalk White - Matt Anthracite - Mud  
 Blanc craie Mat - Anthracite Mat - Boue

▲ Maggiorazione per finitura metallo optional  
 Surcharge for optional metal finish  
 Supplément pour finition métal optionnelle **+ 85**

SARIBCK

489  
\*

499

524

698

N.B.: Piedino con feltro opzionale

N.B.: Optional felt-padded foot - N.B.: Option pied avec patin feutre



Kg 8,9 | M<sup>3</sup> 0,30 | Tessuto/Fabric/Tissu ml. 1,3 - pelle/leather/cuir m<sup>2</sup> 1,9

Per finiture miste seduta/schienale e scocca fare riferimento alla fascia di prezzo più alta tra le due varianti scelte

For mixed seat/back and frame finishes please refer to the highest price category of the two versions chosen

Pour des finitions mixtes pour l'assise/dossier et la coque, se référer à la catégorie de prix la plus haute entre les deux variantes choisies

Non disponibili tessuti Easy

The Easy fabrics are not available

Tissus Easy non disponibles

## Bridge - L 41 P 60 H 97/123 HS 57/83



### Struttura metallo girevole

Swivel metal frame - Structure pivotante en métal

Cromo lucido  
 Gloss chrome  
 Chrome brillant

SBRIMEC

670  
\*

681

691

728

Kg 19,2 | M<sup>3</sup> 0,33 | Tessuto/Fabric/Tissu ml. 0,8 - pelle/leather/cuir m<sup>2</sup> 1,3

## Campus - L 50 P 40 H 65/90 HS 55/80



### Struttura metallo girevole

Swivel metal frame - Structure pivotante en métal

Cromo lucido  
 Gloss chrome  
 Chrome brillant

SCAMMEC

532

-

-

-

-

Solo cuoio  
 rigenerato  
 Only in bonded  
 leather  
 Uniquement en  
 cuir régénéré

Kg 19,5 | M<sup>3</sup> 0,33

# Sgabelli / Stools / Tabourets

▲ N.B. Finiture pag. 90

N.B.: Finishes page 90

N.B.: Finitions page 90

**1/One** Amsterdam / Bora / Dublin / Easy / Maracaibo / Nairobi / Texplast / Ecopelle Twist *Twist eco-leather - Éco-cuir Twist*

**A** Boston / Spice / Marvel / Swing / Cotton / Tessuto cliente minimo 4 pz.

*Customer fabric, min. 4 pcs - Tissu client minimum 4 articles*

**B** Cachemire / Daytona / Econabuk / Sogno / Ecopelle Vintage *Vintage eco-leather - Éco-cuir Vintage*

*Pelle cliente minimo 4 pz. Min. 4 pcs must be ordered with customer's leather - Pour cuir du client, minimum 4 articles.*

**F** Pelle Polo

\* Non disponibile in Texplast

*Not available in Texplast*

Non disponible en Texplast

	cod.	Cat. 1/ONE	Cat. A	Cat. B	Cat. F
--	------	------------	--------	--------	--------

## Carol - L 51 P 57 H 96/65



### Struttura metallo

*Metal frame - Structure métal:*

Opaco bianco gesso - Opaco antracite - Fango  
*Matt Chalk White - Matt Anthracite - Mud*  
 Blanc craie Mat - Anthracite Mat - Boue

SCARMET

487  
\*

497

523

699

▲ Maggiorazione per finitura metallo optional  
*Surcharge for optional metal finish*  
 Supplément pour finition métal optionnelle

+ 85



**N.B.: Piedino con feltro opzionale**

*N.B.: Optional felt-padded foot - N.B.: Option pied avec patin feutre*

Kg 8,9 | M<sup>3</sup> 0,30 | Tessuto/Fabric/Tissu ml. 1,6 - pelle/leather/cuir m<sup>2</sup> 1,9

## Clio - L 41 P 42 H 65/91 HS 54/80



### Struttura metallo girevole

*Swivel metal frame - Structure pivotante en métal*

Cromo lucido  
*Gloss chrome*  
 Chrome brillant

SCLIMEC

509

-

-

-

Solo cuoio  
 rigenerato  
*Only in bonded  
 leather*  
 Uniquement en  
 cuir régénéré



Kg 16,6 | M<sup>3</sup> 0,33

## Diva - L 45 P 56 H 102/65



### Struttura metallo

*Metal frame - Structure métal:*

Opaco bianco gesso - Opaco antracite - Fango  
*Matt Chalk White - Matt Anthracite - Mud*  
 Blanc craie Mat - Anthracite Mat - Boue

SDIVMET

470  
\*

480

504

670

▲ Maggiorazione per finitura metallo optional  
*Surcharge for optional metal finish*  
 Supplément pour finition métal optionnelle

+ 85



**N.B.: Piedino con feltro opzionale**

*N.B.: Optional felt-padded foot - N.B.: Option pied avec patin feutre*

Kg 7,8 | M<sup>3</sup> 0,30 | Tessuto/Fabric/Tissu ml. 1,6 - pelle/leather/cuir m<sup>2</sup> 2,8

## Elena - L 48 P 52 H 105/66



### Struttura metallo

*Metal frame - Structure métal:*

Opaco bianco gesso - Opaco antracite - Fango  
*Matt Chalk White - Matt Anthracite - Mud*  
 Blanc craie Mat - Anthracite Mat - Boue

SELEMET

415  
\*

424

448

615

▲ Maggiorazione per finitura metallo optional  
*Surcharge for optional metal finish*  
 Supplément pour finition métal optionnelle

+ 85



**N.B.: Piedino con feltro opzionale**

*N.B.: Optional felt-padded foot - N.B.: Option pied avec patin feutre*

Kg 7,7 | M<sup>3</sup> 0,30 | Tessuto/Fabric/Tissu ml. 1 - pelle/leather/cuir m<sup>2</sup> 1,9

- 1/One** Amsterdam / Bora / Dublin / Easy / Maracaibo / Nairobi / Texplast / Ecopelle Twist *Twist eco-leather - Éco-cuir Twist*
- A** Boston / Spice / Marvel / Swing / Cotton / Tessuto cliente minimo 4 pz.  
*Customer fabric, min. 4 pcs - Tissu client minimum 4 articles*
- B** Cachemire / Daytona / Econabuk / Sogno / Ecopelle Vintage *Vintage eco-leather - Éco-cuir Vintage*  
 Pelle cliente minimo 4 pz. *Min. 4 pcs must be ordered with customer's leather - Pour cuir du client, minimum 4 articles.*
- F** Pelle Polo

\* Non disponibile in Texplast  
*Not available in Texplast*  
 Non disponible en Texplast

	cod.	Cat. 1/ONE	Cat. A	Cat. B	Cat. F
--	------	------------	--------	--------	--------

## Fez - L 34 P 34 H 65



### Struttura metallo

*Metal frame - Structure métal:*

Opaco bianco gesso - Opaco antracite - Fango  
*Matt Chalk White - Matt Anthracite - Mud*  
 Blanc craie Mat - Anthracite Mat - Boue

▲ **Maggiorazione per finitura metallo optional**  
*Surcharge for optional metal finish*  
 Supplément pour finition métal optionnelle **+ 85**

SFEZMET

283  
\*

293

301

428

**N.B.: Piedino con feltro NON applicabile**

*N.B.: Felt-padded foot NOT available - N.B.: Pied avec patin feutre NON utilisable*



Kg 6,5 | M<sup>3</sup> 0,16 | Tessuto/Fabric/Tissu ml. 0,7 - pelle/leather/cuir m<sup>2</sup> 1,10

## July - L 41 P 41 H 80/65



### Struttura metallo

*Metal frame - Structure métal:*

Opaco bianco gesso - Opaco antracite - Fango  
*Matt Chalk White - Matt Anthracite - Mud*  
 Blanc craie Mat - Anthracite Mat - Boue

### Sedile legno

*Wooden seat - Structure bois:*

Rovere impiallacciato tinto  
 (naturale, carbone, termocotto)  
*Stained oak veneer (Natural, Charcoal or Heat-treated)*  
 Chêne plaqué teinté (nature, charbon, thermo-traité)

▲ **Maggiorazione per finitura metallo optional**  
*Surcharge for optional metal finish*  
 Supplément pour finition métal optionnelle **+ 85**

SJULMET

255  
\*

258

268

347

SJULMEL

236  
\*

-

-

-

**N.B.: Piedino con feltro NON applicabile**

*N.B.: Felt-padded foot NOT available - N.B.: Pied avec patin feutre NON utilisable*



Kg 6,1 | M<sup>3</sup> 0,16 | Tessuto/Fabric/Tissu ml. 0,4 - pelle/leather/cuir m<sup>2</sup> 0,8

## Paris - L 51 P 57 H 93



### Struttura metallo

*Metal frame - Structure métal:*

Opaco bianco gesso - Opaco antracite - Fango  
*Matt Chalk White - Matt Anthracite - Mud*  
 Blanc craie Mat - Anthracite Mat - Boue

▲ **Maggiorazione per finitura metallo optional**  
*Surcharge for optional metal finish*  
 Supplément pour finition métal optionnelle **+ 85**

SPARMET

470  
\*

479

504

675

**N.B.: Piedino con feltro opzionale**

*N.B.: Optional felt-padded foot - N.B.: Option pied avec patin feutre*



Kg 7,5 | M<sup>3</sup> 0,30 | Tessuto/Fabric/Tissu ml. 1,4 - pelle/leather/cuir m<sup>2</sup> 1,9

## Paris bicolore - L 51 P 57 H 93



**Tessuto A**  
*Fabric A*  
 Tissu A

**Tessuto B**  
*Fabric B*  
 Tissu B

### Struttura metallo

*Metal frame - Structure métal:*

Opaco bianco gesso - Opaco antracite - Fango  
*Matt Chalk White - Matt Anthracite - Mud*  
 Blanc craie Mat - Anthracite Mat - Boue

▲ **Maggiorazione per finitura metallo optional**  
*Surcharge for optional metal finish*  
 Supplément pour finition métal optionnelle **+ 85**

SPARBCK

492  
\*

501

526

697

**Per finiture miste seduta/schienale e scocca fare riferimento alla fascia di prezzo più alta tra le due varianti scelte**  
*For mixed seat/back and frame finishes please refer to the highest price category of the two versions chosen*  
 Pour des finitions mixtes pour l'assise/dossier et la coque, se référer à la catégorie de prix la plus haute entre les deux variantes choisies

**N.B.: Piedino con feltro opzionale**

*N.B.: Optional felt-padded foot - N.B.: Option pied avec patin feutre*



Kg 7,5 | M<sup>3</sup> 0,30 | Tessuto/Fabric/Tissu ml. 1,4 - pelle/leather/cuir m<sup>2</sup> 1,9

**1/One** Amsterdam / Bora / Dublin / Easy / Maracaibo / Nairobi / Texplast / Ecopelle Twist *Twist eco-leather - Éco-cuir Twist*

**A** Boston / Spice / Marvel / Swing / Cotton / Tessuto cliente minimo 4 pz.

*Customer fabric, min. 4 pcs - Tissue client minimum 4 articles*

**B** Cachemire / Daytona / Econabuk / Sogno / Ecopelle Vintage *Vintage eco-leather - Éco-cuir Vintage*

*Pelle cliente minimo 4 pz. Min. 4 pcs must be ordered with customer's leather - Pour cuir du client, minimum 4 articles.*

**F** Pelle Polo

\* Non disponibile in Texplast

*Not available in Texplast*

Non disponible en Texplast

	cod.	Cat. 1/ONE	Cat. A	Cat. B	Cat. F
--	------	------------	--------	--------	--------

## Paris gas - L 51 P 57 H 81/112 HS 55/86



**Struttura metallo girevole**  
*Swivel metal frame - Structure pivotante en métal*

Cromo lucido  
*Gloss chrome*  
Chrome brillant

**SPARMEC**

**724**  
\*

**736**

**770**

**996**



Kg 19 | M° 0,30 | Tessuto/Fabric/Tissu ml. 1,4 - pelle/leather/cuir m² 1,9

## Sara - L 46 P 47 H 106/65



**Struttura metallo**  
*Metal frame - Structure métal:*

Opaco bianco gesso - Opaco antracite - Fango  
*Matt Chalk White - Matt Anthracite - Mud*  
Blanc craie Mat - Anthracite Mat - Boue

**SSARMET**

**329**  
\*

**359**

**374**

**534**

▲ **Maggiorazione per finitura metallo optional**  
*Surcharge for optional metal finish* **+ 85**  
Supplément pour finition métal optionnelle



**N.B.: Piedino con feltro NON applicabile**

*N.B.: Felt-padded foot NOT available - N.B.: Pied avec patin feutre NON utilisable*

Kg 8,7 | M° 0,30 | Tessuto/Fabric/Tissu ml. 1,0 - pelle/leather/cuir m² 1,3

## Piedino con feltro optional - Optional felt-padded foot - Option pied avec patin feutre



**Set 4 piedini**  
*Set of 4 feet* **€ 6**  
Ensemble 4 pieds

# Manutenzione tessuto e pelle

Fabric and leather care instructions / Entretien tissu et cuir

Categoria Category Catégorie	Nome Name Nom	Composizione Composition Composition	Certificazione ignifugo Fire-retardant certification Certificación ignífugo
1/One	<b>AMSTERDAM velluto</b>	100% Poliestere / Polyester / Polyester (PL)	BS 5852 0 EN 1021 1
	<b>BORA microfibra</b>	100% Poliestere / Polyester / Polyester (PL)	BS 5852 0
	<b>DUBLIN</b>	100% Poliestere / Polyester / Polyester (PL)	BS 5852 0 EN 1021 1
	<b>MARACAIBO</b>	100% Poliestere / Polyester / Polyester (PL)	
	<b>NAIROBI</b>	100% Poliestere / Polyester / Polyester (PL)	BS 5852 0 EN 1021 1
	<b>ECOPELLE TWIST</b> <i>Eco-leather / Éco-cuir</i>	90 % Compound PVC / PVC compound / Compound PVC 10% Poliestere / Polyester / Polyester (PL)	BS 5852 1 - EN 1021 1/2 TB 117-2013 - NFPA 260 class 1
	<b>EASY</b>	100% Poliestere / Polyester / Polyester (PL)	
	<b>TEXPLAST</b>	77 % Compound PVC / PVC compound / Compound PVC 23% Poliestere / Polyester / Polyester (PL)	
A	<b>SPICE</b>	100% Poliestere / Polyester / Polyester (PL)	
	<b>MARVEL</b>	100% Poliestere / Polyester / Polyester (PL)	
	<b>COTTON CLUB</b>	70 % Cotone / Cotton / Coton (CO) - 10% Poliestere / Polyester / Polyester (PL) 10% Acrilico / Acrylic / Acrylique (PC) - 10% Altre fibre / Other fibers / Autres fibres (AF)	
	<b>SWING</b>	57% Cotone / Cotton / Coton (CO) - 18% Poliestere / Polyester / Polyester (PL) 18% Viscosa / Viscose / Viscose (VI) - 5% Acrilico / Acrylic / Acrylique (PC) 2% Altre fibre / Other fibers / Autres fibres (AF)	
	<b>BOSTON</b>	100% Poliestere / Polyester / Polyester (PL)	BS 5852 1 EN 1021 1 TB 117







Test abrasione/solidità Abrasion/wear resistance test Prueba abrasión/solidez	Altro Other Otro	Lavaggio Washing Lavado	Altro Other Otro
EN ISO 12947 1,2 >100.000	WATER REPELLENT		
EN12947 1,2 >100.000 EN ISO 105 x12 RUBBING DRY 5 RUBBING WET 5	WATER REPELLENT EN ISO 13934 1 Resistenza Trazione / <i>Tensile resistance</i> / Résistance Traction (Ordito / <i>Weft</i> / Chaîne 14,1% - Trama / <i>Warp</i> / Trame 21,4%) EN ISO 13937 3 Resistenza Lacerazione / <i>Tear resistance</i> / Résistance Déchirure (Ordito / <i>Weft</i> / Chaîne 85,7N - Trama / <i>Warp</i> / Trame 95,6N) EN ISO 13936 2 Resistenza Scorrimento Cintura / <i>Resistance to yarn slippage</i> / Résistance Glissement Coutures (Ordito / <i>Weft</i> / Chaîne 2,3mm – Trama / <i>Warp</i> / Trame 3,0mm) EN ISO 105 B02 2 Resistenza Luce / <i>Colour fastness to light</i> / Résistance Lumière 5		
EN ISO 12947 1,2 >100.000	WATER REPELLENT		
>100.000 PILLING 5 - RUBBING DRY 4 RUBBING WET 3/4	WATER REPELLENT IRRESTRINGIBILE / <i>SHRINKPROOF</i> / IRRÉTRÉCISSABLE Resistenza Scorrimento / <i>Slippage resistance</i> / Résistance Glissement (Ordito / <i>Weft</i> / Chaîne 3, Trama / <i>Warp</i> / Trame 5)		
EN ISO 12947 1,2 >100.000	WATER REPELLENT		
EN ISO 5470-2 > 50.000 EN ISO 105 X12 RUBBING DRY 5 - RUBBING WET 5	EN ISO 105 B02 Solidità Luce / <i>Colour fastness to light</i> / Solidité Lumière 5 EN ISO 1421 Resistenza Rottura / <i>Tensile strength</i> / Résistance Rupture (Ordito / <i>Weft</i> / Chaîne 300N - Trama / <i>Warp</i> / Trame 200N)		
EN ISO 12947 2 >50.000 EN ISO 12945 2 - PILLING 4/5 EN ISO 105 X12 RUBBING DRY 4/5 - RUBBING WET 4/5	EN ISO 105 B02 Resistenza Luce / <i>Colour fastness to light</i> / Résistance Lumière 4		
EN ISO 12945 2 >40.000 EN ISO 105 X12 RUBBING DRY 4/5 - RUBBING WET 4 EN ISO 105 B02 - XENOTEST 4	EN ISO 105 B02 Resistenza Luce / <i>Colour fastness to light</i> / Résistance Lumière 4 EN ISO 13934 1 Resistenza Trazione / <i>Tensile resistance</i> / Résistance Traction (Ordito / <i>Weft</i> / Chaîne 2200 - Trama 1260) EN ISO 13937 3 Resistenza Lacerazione / <i>Tear resistance</i> / Résistance Déchirure (Ordito / <i>Weft</i> / Chaîne 240 - Trama / <i>Warp</i> / Trame 96) EN ISO 13936 2 Resistenza Scorrimento Cintura / <i>Resistance to yarn slippage</i> / Résistance Glissement Coutures (Ordito / <i>Weft</i> / Chaîne 3,2 mm – Trama / <i>Warp</i> / Trame 3,3 mm)		
EN ISO 12947 2 >50.000 EN ISO 105 X12 RUBBING DRY 4/5 RUBBING WET 4/5 EN ISO 105 B02 XENOTEST 4	EN ISO 105 B02 Resistenza Luce / <i>Colour fastness to light</i> / Résistance Lumière 4 EN ISO 13934 1 Resistenza Trazione / <i>Tensile resistance</i> / Résistance Traction (Ordito / <i>Weft</i> / Chaîne 670 - Trama / <i>Warp</i> / Trame 820) EN ISO 13937 3 Resistenza Lacerazione / <i>Tear resistance</i> / Résistance Déchirure (Ordito / <i>Weft</i> / Chaîne 57 - Trama / <i>Warp</i> / Trame 33) EN ISO 13936 2 Resistenza Scorrimento Cintura / <i>Resistance to yarn slippage</i> / Résistance Glissement Coutures (Ordito / <i>Weft</i> / Chaîne 1,4 mm – Trama / <i>Warp</i> / Trame 1,2 mm)		
EN ISO 12945-2 - PILLING 4 EN ISO 105 X12 RUBBING DRY 4/5 - RUBBING WET 4 EN ISO 105 B02 - XENOTEST 4/5	EN ISO 105 B02 Resistenza Luce / <i>Colour fastness to light</i> / Résistance Lumière 4/5		
EN ISO 12945-2 - PILLING 4 EN ISO 105 X12 RUBBING DRY 4/5 - RUBBING WET 4 EN ISO 105 B02 - XENOTEST 4/5	EN ISO 105 B02 Resistenza Luce / <i>Colour fastness to light</i> / Résistance Lumière 4/5		
EN ISO 12947 1,2 >80.000 EN ISO 12945 2 PILLING 4/5 EN ISO 105-X12 RUBBING DRY 5 - RUBBING WET 5 EN ISO 105 B02 XENOTEST 4/5	TRASPIRANTE EN ISO 105B02 Resistenza Luce / <i>Colour fastness to light</i> / Résistance Lumière 4/5 EN ISO 13937 3 Resistenza Lacerazione / <i>Tear resistance</i> / Résistance Déchirure (Ordito / <i>Weft</i> / Chaîne 117,1N – Trama / <i>Warp</i> / Trame 29,4N) EN ISO 13934 1 Resistenza Trazione / <i>Tensile resistance</i> / Résistance Traction (Ordito / <i>Weft</i> / Chaîne 2170N – Trama / <i>Warp</i> / Trame 630N) EN ISO 13936 2 Resistenza Scorrimento Cintura / <i>Resistance to yarn slippage</i> / Résistance Glissement Coutures (Ordito / <i>Weft</i> / Chaîne 2,5 mm – Trama / <i>Warp</i> / Trame 3,0 mm) EN ISO 105 B02 Solidità Colore / Solidità Colore / Solidità Colore 4/5		

# Manutenzione tessuto e pelle

*Fabric and leather care instructions / Entretien tissu et cuir*

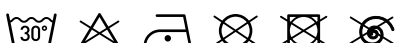
<b>Categoria</b> <i>Category</i> Catégorie	<b>Nome</b> <i>Name</i> Nom	<b>Composizione</b> <i>Composition</i> Composición	<b>Certificazione ignifugo</b> <i>Fire-retardant certification</i> Certificación ignífugo
<b>B</b>	<b>CACHEMIRE</b>	<b>100% Poliestere</b> / Polyester / Polyester (PL)	
	<b>DAYTONA</b>	<b>51% Poliestere</b> / Polyester / Polyester (PL) <b>38% Acetato</b> / Acetate / Acetato <b>11% Poliammide</b> / Polyamide / Polyamide	BS 5852 0,1 EN 1021 1,2
	<b>SOGNO</b>	<b>100% Poliestere</b> / Polyester / Polyester (PL)	
	<b>ECONABUK</b>	<b>41% Poliuretano</b> / Polyurethane / Polyuréthane (PU) <b>47% Poliestere</b> / Polyester / Polyester (PL) <b>9% Cotone</b> / Cotton / Coton (CO) <b>3% Colla</b> / Glue / Colle	
	<b>ECOPELLE VINTAGE</b> <i>Eco-leather / Éco-cuir</i>	<b>80% Polivinilcloruro</b> / Polyvinyl Chloride / Polyvinylchlorure (PVC) <b>2% Poliuretano</b> / Polyurethane / Polyuréthane (PU) <b>18% Poliestere</b> / Polyester / Polyester (PL)	BS 5852 1 EN 1021 1,2 UNI 9175 1/M
<b>F</b>	<b>PELLE POLO</b> <i>Leather / Cuir</i>	<b>Origine animale: bovina</b> / Origin: Raw Hides / Origine animale : bovin <b>Provenienza: Europa</b> / Place of origin: European / Provenance : Europe <b>Tipo di Concia: ai Sali di cromo</b> / Tanning: chrome salts / Type de Tannage : aux sels de chrome <b>Tipo di tintura: all'anilina passante in botte</b> / Dyeing: aniline through-dyeing / Type de teinture : au foulon à l'aniline <b>Tipologia : fiore smerigliato e stampato Uruguay</b> / Typology: corrected and printed grain Uruguay / Type : fleur poncée et imprimée Uruguay	BS 5852 1 TB 117-2013



<b>Test abrasione/solidità</b> <i>Abrasion/wear resistance test</i> Prueba abrasión/solidez	<b>Altro</b> <i>Other</i> Otro	<b>Lavaggio</b> <i>Washing</i> Lavado	<b>Altro</b> <i>Other</i> Otro
EN ISO 12947 2 >35.000 EN ISO 105-X12 RUBBING DRY 4/5 RUBBING WET 4 EN ISO 105 B02 XENOTEST 4	WATER REPELLENT EN ISO 13936 2 (Ordito / Weft / Chaîne 4 mm – Trama / Warp / Trame 2 mm)		
EN ISO 12947 1,2 >200.000 EN ISO 121945 2 PILLING >5 EN ISO 13934-1 EN ISO 105-X12 RUBBING DRY 4 RUBBING WET 4 EN ISO 105 B02 XENOTEST 6	DIN 53859 5 Resistenza Lacerazione / <i>Tear resistance</i> / Résistance Déchirure (Ordito / Weft / Chaîne >20N – Trama / Warp / Trame >3N) EN ISO 13934 1 Resistenza Trazione / <i>Tensile resistance</i> / Résistance Traction >350N DIN 53868 Resistenza Cucitura / <i>Resistance to yarn slippage</i> / Résistance Glissement Coutures (Ordito / Weft / Chaîne <4 mm – Trama / Warp / Trame >6 mm) Fabrics Recommended For Homes With Pets SAFE FRONT®		<b>AQUACLEAN EXTREME</b>
PILLING 4 >100.000 RUBBING DRY 4 RUBBING WET 4 XENOTEST 4/5	WATER REPELLENT IRRESTRINGIBILE / <i>SHRINKPROOF</i> / IRRÉTRÉCISSABLE Resistenza Scorrimento / <i>Slippage resistance</i> / Résistance Glissement (Ordito / Weft / Chaîne 2 mm – Trama / Warp / Trame 1 mm)		
		<div style="display: flex; justify-content: space-between;"> <div style="width: 45%;"> <p>Eventuali macchie si possono eliminare usando un panno inumidito con acqua e sapone neutro.</p> <p><i>Stains can be removed using a cloth moistened with water and mild soap.</i></p> <p>Pour éliminer tout type de taches, utiliser un chiffon humidifié à l'eau et du savon neutre.</p> </div> <div style="width: 45%;"> <p>Non strofinare ma tamponare delicatamente dai bordi al centro della macchia</p> <p><i>Do not rub but dab the stain gently from the edges to the centre.</i></p> <p>Ne pas frotter la tache mais la tamponner délicatement en partant des bords et en allant vers le centre de celle-ci.</p> </div> </div>  	
EN ISO 5470-2 >50.000 EN ISO 105 X12 RUBBING DRY 4/5 RUBBING WET 4/5 EN ISO 105 B02 XENOTEST 6	EN ISO 2411 Adesione / <i>Coating adhesion strength</i> / Adhésion 35 UNI 4818 13 Resistenza Flessioni / <i>Flexural strength</i> / Résistance Flexion 150.000 EN ISO 1421 Resistenza Trazione / <i>Tensile resistance</i> / Résistance Traction (Ordito / Weft / Chaîne 515 – Trama / Warp / Trame 300)		

## FINITURE / FINISHES / FINITIONS

### METALLI / METALS / MATÉRIAUX

#### best seller



BIANCO GESSO  
*Chalk white / Blanc Craie*



ANTRACITE  
*Anthracite / Anthracite*



FANGO  
*Mud / Boue*

#### optional



PLATINO  
*Platinum / Platine*



MADREPERLA  
*Mother of pearl / Nacre*



CANAPA  
*Hemp / Chanvre*



HOT  
*Hot grey / Hot*



ARENA  
*Arena / Arena*



GRIGIO PIACENZA  
*Piacenza grey / Gris Piacenza*



FUMO  
*Smoked / Fumée*



LAVA  
*Lava / Lave*



SMOKE  
*Smoke / Smoke*



ARDESIA  
*Slate / Ardoise*

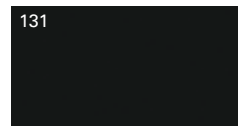

NERO  
*Black / Noir*



GHIACCIO  
*Ice / Givre*



BASALTO  
*Basalt / Basalte*



BROMO  
*Bromine / Brome*



CARTA DA ZUCCHERO  
*Baby blue / Bleu pastel*



ONICE  
*Onyx / Onyx*



BOSCO  
*Forest green / Vert forêt*



SALVIA  
*Sage / Saugue*



BRONZO  
*Bronze / Bronze*



BORDEAUX  
*Burgundy / Bordeaux*

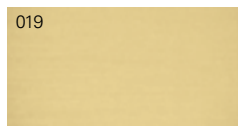

ORO  
*Gold / Or*



TITANIO  
*Titanium / Titane*

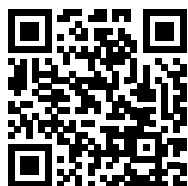

Scansiona il QR code accederai alle finiture del campionario di SEDIT

*By scanning the QR code you will be taken to the SEDIT swatchbooks*

Scannez le code QR pour accéder aux finitions du nuancier SEDIT

## FINITURE / FINISHES / FINITIONS

### VETRO / GLASS / VERRE

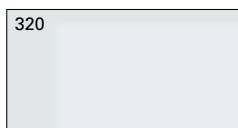

320  
TRASPARENTE  
*Transparent / Transparent*



363  
FUMÈ  
*Smoky grey / Fumée*

### VETRO LUCIDO / GLOSS GLASS / VERRE BRILLANT

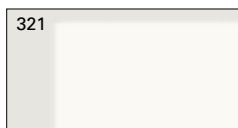

321  
BIANCO GESSO  
*Chalk white / Blanc Craie*



362  
PLATINO  
*Platinum / Platine*

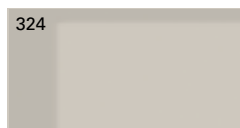

324  
MADREPERLA  
*Mother of pearl / Nacre*



350  
CANAPA  
*Hemp / Chanvre*



327  
HOT  
*Hot grey / Hot*



378  
ARENA  
*Arena / Arena*



330  
GRIGIO PIACENZA  
*Piacenza grey / Gris Piacenza*



361  
FANGO  
*Mud / Boue*



374  
FUMO  
*Smoked / Fumée*



375  
LAVA  
*Lava / Lave*



328  
SMOKE  
*Smoke / Smoke*



360  
ANTRACITE  
*Anthracite / Anthracite*



364  
ARDESIA  
*Slate / Ardoise*



331  
NERO  
*Black / Noir*



373  
GHIACCIO  
*Ice / Givre*

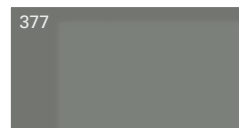

377  
BASALTO  
*Basalt / Basalte*



376  
BROMO  
*Bromine / Brome*



355  
CARTA DA ZUCCHERO  
*Baby blue / Bleu pastel*



367  
ONICE  
*Onyx / Onyx*



368  
BOSCO  
*Forest green / Vert forêt*



359  
SALVIA  
*Sage / Saugé*



356  
BORDEAUX  
*Burgundy / Bordeaux*

## FINITURE / FINISHES / FINITIONS

### MATERICI / TEXTURED / MATÉRIQUES

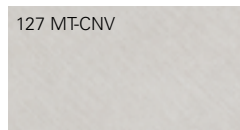

127 MT-CNV  
CANVAS



128 MT-NAM  
NOCE AMBRA  
Amber walnut / Noyer ambre

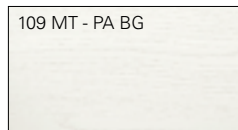

109 MT - PA BG  
PORO APERTO BIANCO  
White open pore  
Pores ouverts blanc

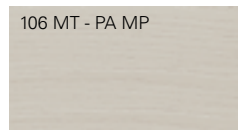

106 MT - PA MP  
PORO APERTO MADREPERLA  
Mother of pearl open pore  
Pores ouverts nacre



108 MT - OC - BG  
BIANCO GESSO  
Chalk white / Blanc Craie

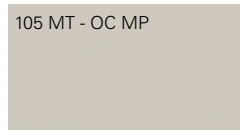

105 MT - OC MP  
MADREPERLA  
Mother of pearl / Nacre

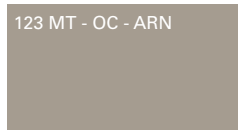

123 MT - OC - ARN  
ARENA  
Arena / Arena

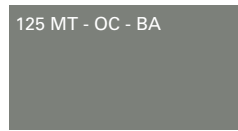

125 MT - OC - BA  
BASALTO  
Basalt / Basalte

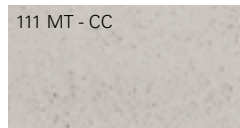

111 MT - CC  
CEMENTO CHIARO  
Light cement / Ciment clair

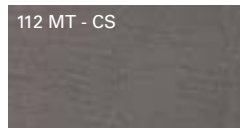

112 MT - CS  
CEMENTO SCURO  
Dark cement / Ciment foncé

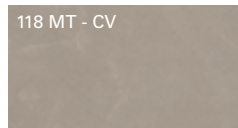

118 MT - CV  
CEMENTO CAVA  
Cava cement / Ciment cava

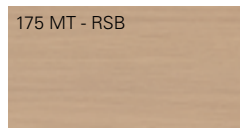

175 MT - RSB  
ROVERE SABBIA  
Sand oak / Chêne sable

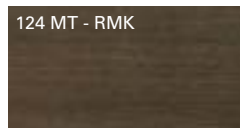

124 MT - RMK  
ROVERE MOKA  
Mocha oak / Chêne moka

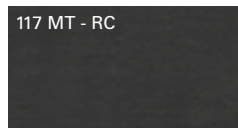

117 MT - RC  
ROVERE CARBONE  
Coal oak / Chêne charbon

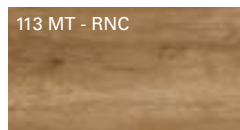

113 MT - RNC  
ROVERE NODATO CHIARO  
Light knotted oak  
Chêne nœuds clair

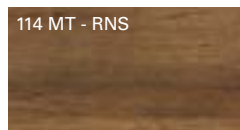

114 MT - RNS  
ROVERE NODATO SCURO  
Dark knotted oak  
Chêne nœuds foncé

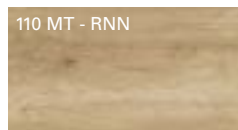

110 MT - RNN  
ROVERE NODATO NATURALE  
Natural knotted oak  
Chêne nœuds naturel

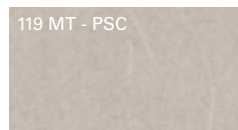

119 MT - PSC  
PIASENTINA CHIARA  
Light Piasentina / Piasentina claire



153 MT - PSS  
PIASENTINA SCURA  
Dark Piasentina / Piasentina foncée

### CERAMICA ELEGANCE / ELEGANCE CERAMIC / CÉRAMIQUE ELEGANCE



012  
PIETRA ANTRACITE  
Anthracite Stone  
Statuaire Blanc mat



020  
STATUARIO BIANCO OPACO  
Matt Statuary White  
Statuaire Blanc mat



032  
FOKOS TERRA  
Umber fokos  
Fokos terre



033  
FOKOS PIOMBO  
Lead fokos  
Fokos plomb



034  
URBAN MARBLE



035  
AMANI

### CERAMICA PREMIUM / PREMIUM CERAMIC / CERÁMICA PREMIUM



040  
CALACATTA ORO VENATO  
LUCIDO  
Gloss veined gold Calacatta  
Calacatta or veiné brillant



041  
NOIR DESIR LUCIDO  
Gloss Noir Desir  
Noir Désir brillant



042  
EMPERADOR LUCIDO  
Gloss emperador  
Emperador brillant

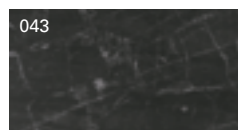

043  
NERO GRECO LUCIDO  
Gloss greek black  
Noir grec brillant



070  
CALATORAO SILK



071  
ABU DHABI SILK



072  
PULPIS SILK

## FINITURE / FINISHES / FINITIONS

### GLASS DECOR / GLASS DECOR / GLASS DECOR

Vetro temperato retro stampato con protettivo: stampa digitale su vetro extrachiaro con fondo retrostampa protettivo bianco.  
*Rear-printed tempered glass with protection: digital print on extra-clear glass with protective, white, rear-print backing.*  
Verre trempé imprimé sur face arrière avec protection : impression numérique sur verre extra clair avec fond de protection blanc sur face arrière imprimée.



COD. 01



COD. 02



COD. 03



COD. 04



COD. 05



COD. 06



COD. 07



COD. 08



COD. 09



COD. 10



COD. 11



COD. 12



COD. 13



COD. 14



COD. 15

# FINITURE / FINISHES / FINITIONS

**AMSTERDAM velluto**  
cat. **1/One**

 BS 5852-0 / EN 1021-1

 **WATER REPELLENT**

     
**100% Poliestere** / Polyester / Polyester (PL)



AMSTERDAM 02



AMSTERDAM 04

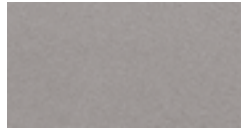

AMSTERDAM 16



AMSTERDAM 23

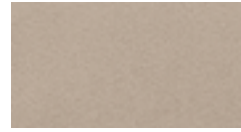

AMSTERDAM 24



AMSTERDAM 37

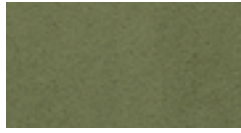

AMSTERDAM 38

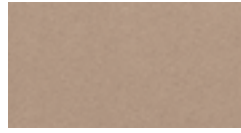

AMSTERDAM 44

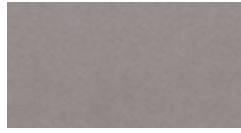

AMSTERDAM 64

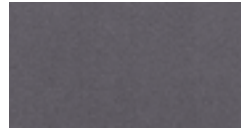

AMSTERDAM 66

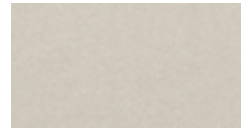

AMSTERDAM 116



AMSTERDAM 135



AMSTERDAM 154



AMSTERDAM 164



AMSTERDAM 173



AMSTERDAM 174



AMSTERDAM 176



AMSTERDAM 183

**BORA microfibra**  
cat. **1/One**

 BS 5852-0

 **WATER REPELLENT**

     
**100% Poliestere** / Polyester / Polyester (PL)

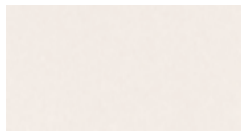

BORA 01



BORA 02

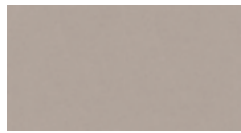

BORA 06

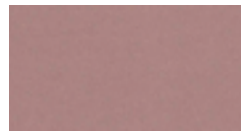

BORA 13



BORA 23



BORA 26



BORA 35

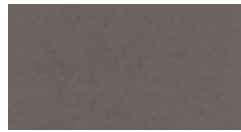

BORA 36



BORA 46

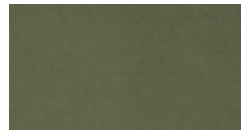

BORA 48



BORA 56



BORA 64



BORA 79



BORA 84



BORA 87



BORA 99



BORA 134

# FINITURE / FINISHES / FINITIONS

## DUBLIN cat. 1/One



BS 5852-0



**WATER REPELLENT**



**100% Poliestere** / Polyester / Polyester (PL)

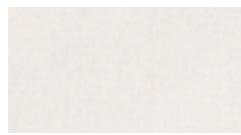

DUBLIN 00



DUBLIN 06



DUBLIN 14



DUBLIN 16

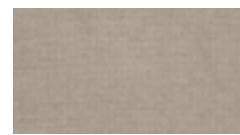

DUBLIN 24

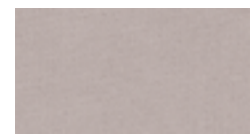

DUBLIN 26



DUBLIN 27



DUBLIN 36



DUBLIN 37



DUBLIN 38



DUBLIN 44



DUBLIN 54



DUBLIN 56



DUBLIN 58



DUBLIN 84

## MARACAIBO cat. 1/One



**WATER REPELLENT**



**100% Poliestere** / Polyester / Polyester (PL)



MARACAIBO 100



MARACAIBO 310



MARACAIBO 405



MARACAIBO 406



MARACAIBO 503



MARACAIBO 602



MARACAIBO 702



MARACAIBO 714



MARACAIBO 804

## NAIROBI cat. 1/One



BS 5852-0 / EN 1021-1



**WATER REPELLENT**



**100% Poliestere** / Polyester / Polyester (PL)

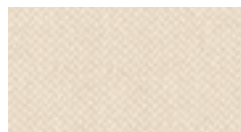

NAIROBI 01



NAIROBI 03



NAIROBI 04



NAIROBI 06



NAIROBI 08



NAIROBI 24



NAIROBI 25



NAIROBI 26



NAIROBI 34

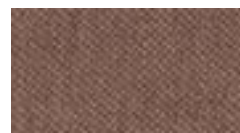

NAIROBI 44



NAIROBI 54

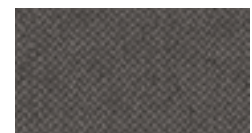

NAIROBI 56



NAIROBI 63



NAIROBI 67



NAIROBI 74

# FINITURE / FINISHES / FINITIONS

## ECOPELLETWIST cat. 1/One



BS 5852-1 / EN 1021-1/2 / TP 117-2013



**90 % Compound PVC / PVC compound / Compound PVC**  
**10% Poliestere / Polyester / Polyester (PL)**



TWIST 101



TWIST 105

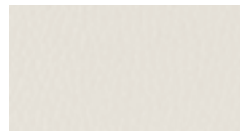

TWIST 111



TWIST 200



TWIST 302



TWIST 400



TWIST 401



TWIST 402



TWIST 403



TWIST 404



TWIST 406



TWIST 421

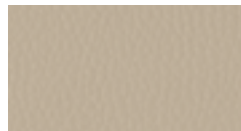

TWIST 600



TWIST 601

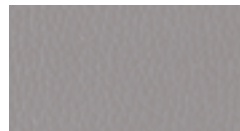

TWIST 602



TWIST 603



TWIST 608



TWIST 702

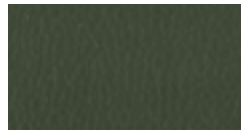

TWIST 801

## EASY cat. 1/One

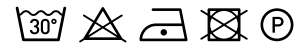

**100% Poliestere / Polyester / Polyester (PL)**



EASY 1



EASY 18



EASY 17



EASY 5

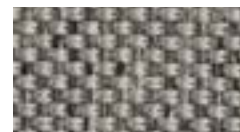

EASY 19

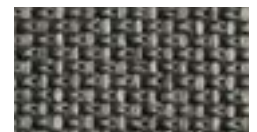

EASY 20



EASY 21



EASY 16



EASY 6



EASY 9

## TEXPLAS - Solo per modello Eva / for the Eva model only / uniquement pour modèle Eva cat. 1/One

**77 % Compound PVC / PVC compound / Compound PVC**  
**23% Poliestere / Polyester / Polyester (PL)**

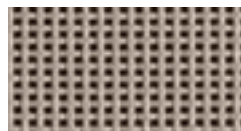

TEXPLAST  
TORTORA 711



TEXPLAST  
GRIGIO PERLA 601



TEXPLAST  
GRIGIO SCURO 670



TEXPLAST  
NERO 400



# FINITURE / FINISHES / FINITIONS

## SPICE

cat. **A**



**100% Poliestere** / Polyester / Polyester (PL)



SPICE 1



SPICE 2



SPICE 4



SPICE 5



SPICE 6

## MARVEL

cat. **A**



**100% Poliestere** / Polyester / Polyester (PL)



MARVEL 1



MARVEL 3



MARVEL 4



MARVEL 5



MARVEL 7



MARVEL 9



MARVEL 10

## COTTON CLUB

cat. **A**

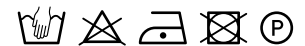

**70 % Cotone** / Cotton / Coton (CO) - **10% Poliestere** / Polyester / Polyester (PL) - **10% Acrilico** / Acrylic / Acrylique (PC) - **10% Altre fibre** / Other fibers / Autres fibres (AF)



COTTON CLUB 101

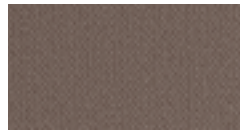

COTTON CLUB 105



COTTON CLUB 106



COTTON CLUB 111

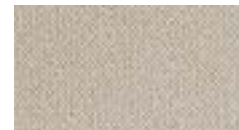

COTTON CLUB 113



COTTON CLUB 119

## SWING

cat. **A**

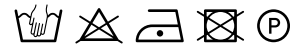

**57 % Cotone** / Cotton / Coton (CO) - **18% Poliestere** / Polyester / Polyester (PL) - **18% Viscosa** / Viscose / Viscose (VI) - **5% Acrilico** / Acrylic / Acrylique (PC) - **2% Altre fibre** / Other fibers / Autres fibres (AF)

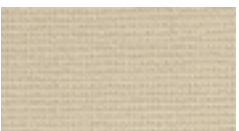

SWING 201



SWING 205

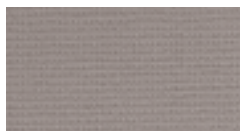

SWING 206



SWING 211

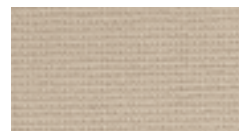

SWING 213



SWING 219

## BOSTON

cat. **A**

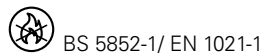

BS 5852-1/ EN 1021-1

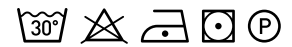

**100% Poliestere** / Polyester / Polyester (PL)



BOSTON ASH



BOSTON BLACK



BOSTON CEMENT



BOSTON FORREST



BOSTON LIGHT GREY



BOSTON MOSTAZA



BOSTON MOUSE



BOSTON OCEAN



BOSTON WATER GREEN

# FINITURE / FINISHES / FINITIONS

## CACHEMIRE cat. B



400



500



602



603



707



800



999

## DAYTONA cat. B

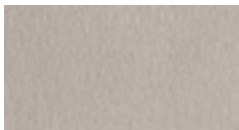
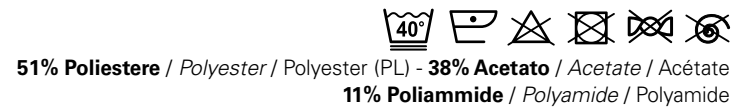
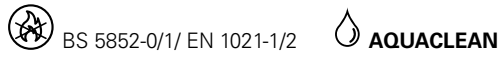

DAYTONA 60

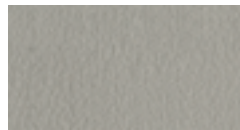

DAYTONA 76



DAYTONA 77



DAYTONA 78



DAYTONA 109



DAYTONA 139



DAYTONA 158



DAYTONA 165

## SOGNO cat. B

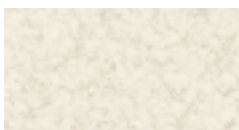

400



607



605



606



603



702



806



903

# FINITURE / FINISHES / FINITIONS

## ECONABUK

cat. **B**

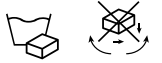

**41% Poliuretano / Polyurethane / Polyuréthane (PU) - 47% Poliestere / Polyester / Polyester (PL)**  
**9% Cotone / Cotton / Coton (CO) - 3% Colla / Glue / Colle**



01



02



03



05



07



08



11



12



13

## ECOPELLE VINTAGE

cat. **B**



BS 5852-1 / EN 1021-1/2 / UNI 9115 1/M



**80% Polivinilcloruro / Polyvinyl Chloride / Polyvinylchlorure (PVC)**

**2% Poliuretano / Polyurethane / Polyuréthane (PU) - 18% Poliestere / Polyester / Polyester (PL)**



E. VINTAGE 102



E. VINTAGE 106

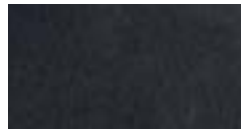

E. VINTAGE 1011



E. VINTAGE 101



E. VINTAGE 103



E. VINTAGE 107

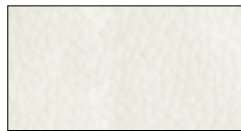

E. VINTAGE 1008



E. VINTAGE 1009



E. VINTAGE 1015

## PELLE POLO

cat. **F**



BS 5852-1 / TB 117-2013

**Origine animale: bovina / Origin: Raw Hides / Origine animale : bovin**

**Provenienza: Europa / Place of origin: European / Provenance : Europe**

**Tipo di Concia: ai Sali di cromo / Tanning: chrome salts / Type de Tannage : aux sels de chrome**

**Tipo di tintura: all'anilina passante in botte / Dyeing: aniline through-dyeing / Type de teinture : au foulon à l'aniline**

**Tipologia : fiore smerigliato e stampato Uruguay / Typology: corrected and printed grain Uruguay / Type : fleur poncée et imprimée Uruguay**



810



819



824

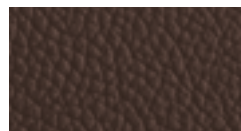

825



832

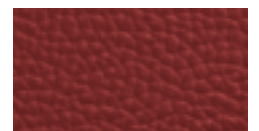

844

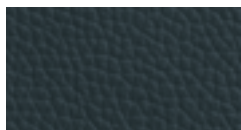

857

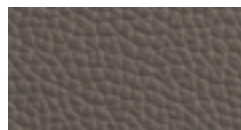

858

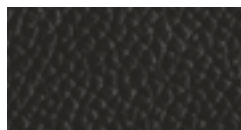

860



930



931



932

# Manutenzione materiali speciali

## Special care instructions / Entretien des matériaux spéciaux

IT

### Vetro temperato

Il vetro temperato si ottiene sottoponendo le lastre di vetro ad un trattamento termico a circa 700 gradi ed eseguendo successivamente un raffreddamento istantaneo, volto a creare una compressione superficiale in grado di aumentare la resistenza della lastra alle sollecitazioni meccaniche e allo sgocciolio termico. Resiste a temperature superiori a 250°.

Il Vetro temperato è considerato "vetro di sicurezza" in quanto, a seguito di rottura, si frammenta in tanti piccoli pezzi non pericolosi per l'incolumità delle persone.

### Ceramica: caratteristiche tecniche

Un'elevata resistenza alle sollecitazioni meccaniche, ai prodotti chimici, all'usura, ai graffi, all'abrasione profonda e alla flessione, è facilmente igienizzabile, resistente al gelo, al fuoco, alle muffe e all'azione dei raggi UV. Sono tutte le caratteristiche e le proprietà cromatiche delle lastre sono inalterabili, restando immutate nel tempo ed in presenza di ogni condizione atmosferica.

Un materiale rivoluzionario che non dimentica l'attenzione all'ambiente: materie prime naturali, tecnologia sostenibile.

### Piani materici

I piani in materico sono pannelli composti da particelle di legno i cui lati sono rivestiti da carte decorative o foglie polimeriche e sono chiusi da bordi generalmente in PVC.

I piani se conservati adeguatamente sono resistenti all'usura e all'azione del tempo, non subiscono variazioni di colore se esposti alla luce del sole. Per la pulizia di questi piani è bene non utilizzare materiali o prodotti abrasivi tipo pagliette o spugne ruvide, né creme abrasive o detersivi in polvere perché potrebbero compromettere l'integrità delle superfici. L'uso di detersivi chimici o particolarmente aggressivi non è consigliato. Da evitare assolutamente l'uso di Acetone, perché potrebbe danneggiare i bordi in materiale plastico, Trielina, Ammoniaca, Alcool Etilico detersivi acidi, come la candeggina, o basici, come l'ammoniaca pura. Sui piani in materico non vanno appoggiate pentole calde. Attenzione alle bordature dei piani: eccessi di acqua o liquidi in genere, calore e umidità possono comportare scollamenti e deformazioni che non rientrano nei difetti imputabili ai pannelli utilizzati o alle lavorazioni degli stessi. Asciugare sempre immediatamente con un panno e con cura acqua e vapori, evitando il contatto prolungato con fonti di calore. Questi materiali non sono stati testati per una permanenza all'aperto. Si possono pulire con un panno in microfibra inumidito con dell'acqua, eventualmente con l'aggiunta di un detersivo neutro. Per evitare la formazione di aloni, ripassare alla fine con un panno asciutto. Le macchie di inchiostro possono essere trattate localmente con alcool denaturato e panno morbido, ma in linea di massima l'alcool deve essere usato con cautela perché troppo aggressivo.

EN

### Tempered glass

The tempered glass is obtained subjecting the glass sheets to an heat treatment at about 700 degrees and then making an instantaneous cooling, to create a surface compression able to increase the resistance of the plate to the mechanical stresses and to the thermal shock. It resists to temperatures above 250 degrees. Tempered glass is considered safety glass since, as a result of breakage, it is fragmented into many small pieces that are not dangerous for the safety of people.

### Ceramic: technical characteristic

The ceramic has an high resistance to mechanical stress, chemicals, scratches, deep abrasion and bending. It is easily sanitized, resistant to frost, to fire, to mold and UV rays. All the characteristics and the chromatic properties of the slabs are unalterable, remaining unchanged over time. A revolutionary material that does not forget the attention to the environment: natural raw materials and sustainable technology.

### Textured tops

Textured tops are wood particleboard panels whose sides are covered with decorative paper or sheets of polymer and that are usually edged with PVC.

If properly looked after, these tops are resistant to wear and durable, as well as not being subject to colour modifications due to exposure to sunlight. To clean these tops, it's best not to use abrasive materials or products such as coarse sponges, scouring pads, abrasive pastes or powder detergents that may damage the surfaces. It is unadvisable to use chemical or particularly aggressive detergents. It is strictly prohibited to use acetone as it may damage any plastic edgings. The following are also prohibited: trichlorethylene, ammonia, ethyl alcohol, acid-base detergents such as bleach or alkaline-based ones like pure ammonia. Never place red hot pots and pans on textured tops. Take particular care with the edgings of tops: excess water or liquids in general as well as heat and humidity can cause ungluing and deformations of the edgings that cannot be considered intrinsic faults in the panels themselves or in the way they are made. Mop up any water or steam immediately with a cloth and avoid prolonged contact with sources of heat. These materials have not been tested for outdoor use. They can be cleaned with a microfibre cloth moistened with water and, if necessary, with the addition of some neutral detergent. To prevent stains from forming, remove any residual moisture with a dry cloth. You can treat ink stains locally with methylated spirits and a soft cloth but, generally speaking, alcohol must be used sparingly because it is too aggressive.

FR

### Verre trempé

Le verre trempé est obtenu en soumettant les feuilles de verre à un traitement thermique d'environ 700 degrés et en effectuant successivement un refroidissement instantané, de façon à créer une compression superficielle afin d'augmenter la résistance de la feuille aux sollicitations mécaniques et aux chocs thermiques. Résiste aux températures supérieures à 250°.

Le verre trempé est considéré « verre de sécurité » puisque, par suite de bris, il se fragmente en de nombreux petits morceaux non dangereux pour la sécurité des personnes.

### Céramique : caractéristiques techniques

Une haute résistance aux sollicitations mécaniques, aux produits chimiques, à l'usage, aux éraflures, à l'abrasion profonde et à la flexion, est facile à nettoyer, résistant au gel, au feu, aux moisissures et aux actions des rayons UV.

Toutes les caractéristiques et les propriétés chromatiques des plaques sont inaltérables, en restant inchangées au fil du temps et en présence de toute condition atmosphérique. Une matériau révolutionnaire qui n'oublie pas l'accent sur l'environnement : matières premières naturelles, technologie durable.

### Plateaux texturés

Les plateaux texturés sont des panneaux de particules revêtus, sur les deux faces, d'un papier décoratif ou bien enrobés polymère et avec des chants généralement réalisés en PVC. Les plateaux adéquatement maintenus résistent à l'usage et à l'action du temps et ne changent pas de couleur à condition de ne pas les exposer à la lumière du soleil. Pour l'entretien de ces plateaux, il est bon de ne pas utiliser de matériaux ou de produits abrasifs du type paille de fer ou éponge rugueuse, ni de crèmes abrasives ou de produits de nettoyage en poudre car ils pourraient abîmer leur surface. L'utilisation de produits de nettoyage chimiques ou particulièrement agressifs est vivement déconseillée. Il faudra absolument éviter d'utiliser de l'Acétone, car il pourrait abîmer les chants en matière plastique, du Trichloréthylène, de l'Ammoniaque, de l'Alcool éthylique et tout type de produit acide comme l'eau de Javel ou basique comme l'Ammoniaque pur. Il ne faudra pas poser de casseroles chaudes sur les plateaux texturés. Attention aux chants des plateaux : l'eau en excès ou les liquides en général ainsi que la chaleur ou l'humidité peuvent les décoller ou les déformer et ces problèmes ne font pas partie des défauts imputables aux panneaux utilisés ou aux façonnages réalisés. Essuyer immédiatement et avec soin l'eau et la vapeur avec un chiffon et éviter le contact prolongé avec toute source de chaleur. Ces matériaux n'ont pas été testés pour un usage extérieur. On pourra les nettoyer avec un chiffon en microfibre humidifié à l'eau. Si nécessaire, on pourra ajouter un produit de nettoyage neutre. Pour éviter la formation d'auréoles, essuyer à la fin un chiffon sec. Les taches d'encre peuvent être traitées localement avec de l'alcool dénaturé et un chiffon doux, mais en principe, il est préférable d'utiliser l'alcool avec prudence parce qu'il s'agit d'un produit trop agressif.

# Legenda simboli / Key of symbols / Légende des symboles

	LAVAGGIO A MANO <i>Hand wash only / Lavage à la main</i>		EVENTUALI MACCHIE SI POSSONO ELIMINARE USANDO UN PANNO INUMIDITO CON ACQUA E SAPONE NEUTRO. <i>Stains can be removed using a cloth moistened with water and mild soap.</i> Il est possible d'éliminer les taches en utilisant un chiffon humidifié à l'eau et du savon neutre.
	NO CANDEGGIO <i>Do not bleach / Eau de javel interdite</i>		NON STROFINARE MA TAMPONARE DELICATAMENTE DAI BORDI AL CENTRO DELLA MACCHIA. <i>Do not rub but dab the stain gently from the edges to the centre.</i> Ne pas froter, mais tamponner délicatement la tache du bord vers le centre.
	NON ASCIUGARE IN ASCIUGATRICE <i>Do not tumble dry / Sèche-linge interdit</i>		RESISTENZA AL FUOCO <i>Fire resistance / Résistance au feu</i>
	ASCIUGARE A BASSA TEMPERATURA <i>Tumble dry low heat / Séchage à basse température</i>		IDROREPELENTE <i>Idrorepellent / Hydrofuge</i>
	ASCIUGARE DISTESO NO CENTRIFUGA <i>Tumble dry low heat / Séchage à plat essorage interdit</i>		
	NON STRIZZARE <i>Do not wring / Ne pas tordre</i>		
	LAVAGGIO MAX 30° <i>Wash at or below 30° C - 80° F / Lavage à 30° c max</i>		
	MAX 30° LAVAGGIO DELICATO <i>Max 30° C - 80° F cycle permanent press</i> Lavage délicat à 30° c max		
	MAX 40° LAVAGGIO DELICATO SPECIALE <i>Max 40° C - 105° F cycle delicate</i> Lavage délicat spécial à 40° c max		
	NON LAVARE CON ACQUA <i>Do not wash / Ne pas laver à l'eau</i>		
	NO CENTRIFUGA <i>Do not spin / Essorage interdit</i>		
	NON LAVARE A SECCO <i>Do not dry clean / Nettoyage à sec interdit</i>		
	LAVAGGIO CON PERCLOROETILENE <i>Any solvent except / Nettoyage à sec au perchloroéthylène</i>		
	LAVAGGIO A SECCO DELICATO CON PERCLOROETILENE <i>Dry clean gentle any solvent except</i> Nettoyage à sec délicat au perchloroéthylène		
	NON STIRARE <i>Do not iron / Ne pas repasser</i>		
	BASSA TEMPERATURA <i>Low / Basse température</i>		
	MEDIA TEMPERATURA <i>Medium / Température moyenne</i>		
	STIRARE AL CONTRARIO <i>Iron inside out / Repasser à l'envers</i>		

# Condizioni di vendita / *Terms and conditions* / Conditions de vente

IT

## Prezzi

I prezzi del seguente listino sono espressi in unità di Euro. I prezzi sono al pubblico I.V.A. esclusa. I prezzi non costituiscono offerta e sono suscettibili di variazione senza alcun preavviso. I prezzi s'intendono FRANCO FABBRICA, salvo diverso patto espresso.

## Ordini

Gli ordini sono accettati con la clausola "salvo approvazione della Casa". Per consegne della collezione SEDIT di ordine con importo netto inferiore a 300,00 Euro verrà applicato un contributo forfettario pari a 30,00 Euro per il territorio italiano (ad esclusione delle regioni Sicilia e Sardegna 50,00 Euro).

## Reclami

Le contestazioni per danni derivanti dal trasporto devono essere fatte al momento dello scarico. Eventuali reclami per difetti di fabbricazione dovranno essere comunicati entro 8 giorni dal ricevimento della merce. Viene declinata ogni responsabilità per errori o anomalie riscontrate nel montaggio di nostri modelli, salvo non sia stato effettuato da nostro personale specializzato.

## Resi

I resi per difetto di fabbricazione dovranno essere preventivamente autorizzati per iscritto e dovranno pervenirci perfettamente imballati. Qualora, ad insindacabile giudizio dell'azienda vengono riconosciuti i difetti contestati, gli stessi verranno accreditati al valore effettivamente pagato.

## Pagamenti

Non sono validi i pagamenti se non fatti direttamente alla nostra sede. In caso di ritardato pagamento decorreranno gli interessi commerciali nella misura del tasso ufficiale di sconto e comunque secondo le disposizioni di cui al (DL 231 del 09.10.02). La merce rimane di proprietà della Sedit S.r.l. fino a completo pagamento della fattura di riferimento.

## Foro competente

Per ogni controversia il foro competente è eletto a Pordenone. Il presente listino annulla e sostituisce il precedente e potrà essere modificato senza preavviso alcuno in ragione degli aumenti delle materie prime, del costo della manodopera e quant'altro potrà verificarsi in maniera imprevedibile. Le descrizioni e le caratteristiche tecniche dei prodotti richiamati nel presente listino sono puramente indicativi e non vincolanti. L'azienda si riserva il diritto di modificare, senza alcun preavviso, i materiali e le caratteristiche tecniche dei prodotti per motivi tecnici e/o produttivi. Le misure indicate sono espresse in centimetri e in pollici. Per differenze riscontrate tra fotografico, sito e catalogo digitale, fa fede l'ultima versione del presente listino stampato dall'Azienda.

EN

## Prices

The prices are given in euros. The prices are for the public and do not include VAT. The prices do not constitute an offer and are subject to change without any prior notice. Unless otherwise agreed, the prices are to be considered ex-works.

## Orders

Orders are accepted with the clause "subject to approval by Sedit S.r.l.". For orders from the SEDIT collection of below Euro 300.00 (net), a Euro 30.00 fixed fee is applied to deliveries in Italy (with the exception of Sicily and Sardinia, for which the applicable fee is Euro 50.00).

## Complaints

Any damage caused during transportation should be contested when the furniture is being unloaded. Any complaints regarding manufacturing defects must be submitted within 8 days of receiving the goods. We take no responsibility for any assembling errors or defects where the work was not carried out by our specialist staff.

## Returns

Returns due to manufacturing defects are subject to prior written approval and must be shipped to Sedit S.r.l. properly packaged. Should the contested defects be acknowledged, at the sole discretion of Sedit S.r.l., they will be credited at the value actually paid.

## Payments

Only payments made directly to our company headquarters are valid. Late payments will incur interest at the official bank rate, and, in all cases, according to Italian Legislative Decree no. 231 of 09.10.02. The goods shall remain the property of Sedit S.r.l. until the invoice has been paid in full.

## Jurisdiction

For any disputes, the court of Pordenone (Italy) has jurisdiction. The current price list cancels and replaces the previous one and may be modified without notice, should the cost of the raw materials or labour increase, or should any other unforeseeable event arise. The product descriptions and technical characteristics in this price list are merely indicative and are not binding. The company reserves the right to modify the product materials or technical characteristics for technical and/or production reasons without any prior warning. Sizes are given in centimetres and inches. In the event of differences between the photo catalogue, the website and the digital catalogue, the latest update of this price list printed by our company must be referred to as valid.

FR

## Prix

Les prix du catalogue suivant sont exprimés en Euro. Les prix sont des prix publics sans T.V.A.. Les prix ne constituent pas une offre et sont susceptibles de variation sans aucun préavis. Les prix s'entendent FABRICATION FRANÇAISE, sauf convention express contraire.

## Commandes

Les commandes sont acceptées avec la clause « sauf autorisation de la Maison ». Pour les livraisons de la collection SEDIT de commande d'un montant net inférieur à 300,00 Euro, une contribution forfaitaire d'environ 30,00 Euro sera appliquée pour le territoire italien (à l'exception des régions de Sicile et Sardaigne : 50,00 Euro).

## Réclamations

Les contestations pour les dommages dérivants du transport doivent être exprimées au moment du déchargement. Les éventuelles réclamations pour les défauts de fabrication devront être communiquées dans les 8 jours suivant la réception de la marchandise. Nous déclinons toute responsabilité en cas d'erreur ou d'anomalie rencontrée dans le montage de nos modèles. Sauf s'il a été effectué par notre personnel spécialisé.

## Retours

Les retours pour défaut de fabrication devront être préalablement autorisés par écrit et devront nous parvenir parfaitement emballés. Si, par la suite l'entreprise venait à reconnaître les défauts contestés à sa seule discrétion, ils seront crédités à la valeur effectivement payée.

## Paiements

Les paiements ne sont valables que s'ils sont effectués directement à notre siège. En cas de retard de paiement, les intérêts commerciaux courent à hauteur du taux d'escompte officiel et donc conformément aux dispositions du (DL 231 du 09.10.02). La marchandise reste la propriété de Sedit S.r.l. jusqu'au paiement total de la facture de référence.

## Jurisdiction compétente

Pour tout litige, la juridiction compétente est éeue à Pordenone. Le présent catalogue annule et remplace le précédent et pourra être modifié sans préavis en raison des augmentations des matières premières, du coût de la main d'œuvre et de tout autre risque pouvant se produire de manière imprévisible. Les descriptions et les caractéristiques techniques des produits repris dans le présent catalogue sont purement indicatives et non obligatoires. L'entreprise se réserve le droit de modifier, sans aucun préavis les matériaux et les caractéristiques techniques des produits à des fins techniques et/ou de production. Les dimensions indiquées sont exprimées en centimètres et en pouces. Pour toute différence entre le catalogue photographique, le site et le catalogue numérique, c'est la dernière version du présent tarif imprimé par Sedit qui fera foi.

È vietata ogni riproduzione totale e parziale in Italia e all'estero.

Reproduction of all or any part of this publication in Italy or any other country is prohibited.

Toute reproduction totale et partielle en Italie et à l'étranger est interdite.

#### **TOMASELLA DESIGN NETWORK**

Thanks to:  
Tomasella  
Astolfi 1963

---

L'azienda si riserva la facoltà di modificare, senza alcun preavviso, la tipologia di materiali e prodotti al fine di ottimizzare il sistema produttivo, senza andare a sminuire il valore del prodotto.

*The company reserves the authority to change, without notice, the type of materials and products in order to optimize the production system, without diminishing the value of the product.*

L'entreprise se réserve le droit de modifier, sans aucun préavis, la typologie des matériaux et des produits afin d'optimiser le système de production, sans diminuer la valeur du produit.

ATTIVITÀ REALIZZATA CON  
IL CONTRIBUTO DI CUI ALLA  
L.R. 4/2013 ART. 15 INCENTIVI  
PER LA REALIZZAZIONE  
DI PROGETTI DI  
AGGREGAZIONE IN RETE  
DELLE PMI DEL F.V.G.

**SEEDIT srl**

**Via Ruiat, 2 Polcenigo 33070 Italy**

**Ph. +39 0434 627857 Fax +39 0434 606310**

**info@sedit-italia.it www.sedit-italia.it**