



■ Vers. 322



■ Vers. 122





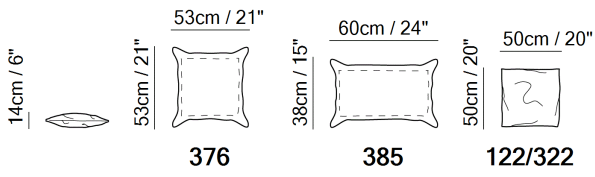

■ Vers. 376+385

## SCHEMATICS

---



TECHNICAL INFORMATION

	<b>COVERING</b>	Leather <input checked="" type="checkbox"/>	Soft Cover <input checked="" type="checkbox"/>				
	<b>FILLING</b>	Arms	<input checked="" type="checkbox"/> Fiber <input type="checkbox"/> Foam <input type="checkbox"/> Feather/Fiber Mix <input type="checkbox"/> Feather	Seat cushion	<input checked="" type="checkbox"/> Fiber <input type="checkbox"/> Foam <input type="checkbox"/> Feather/Fiber Mix <input type="checkbox"/> Feather	Back cushion	<input checked="" type="checkbox"/> Fiber <input type="checkbox"/> Foam <input type="checkbox"/> Feather/Fiber Mix <input type="checkbox"/> Feather
	<b>COMFORT</b>	Standard Comfort <input checked="" type="checkbox"/>	Firm Comfort <input type="checkbox"/>				
	<b>FUNCTION</b>	Bed <input type="checkbox"/>	Electric motion <input type="checkbox"/>	Motion <input type="checkbox"/>	Recliner <input type="checkbox"/>	Sliding <input type="checkbox"/>	
	<b>LEGS</b>	Wood <input type="checkbox"/>	Metal <input type="checkbox"/>	Upholstered <input type="checkbox"/>	Plastic <input type="checkbox"/>	Castors <input type="checkbox"/>	

NOTES

- Model is available with contrast welt (or any another decorative detail such as a band under arm cushion) to be entered as second covering in the same category.
- Available in leather (TG only) or fabric.
- TWO TONE COVERING OPTIONS IN FABRIC:
- 1° COV. = Contrast welt
- 2° COV. = Cushions

NOTES

---



■ Vers. 010+243



■ Vers. 091+253





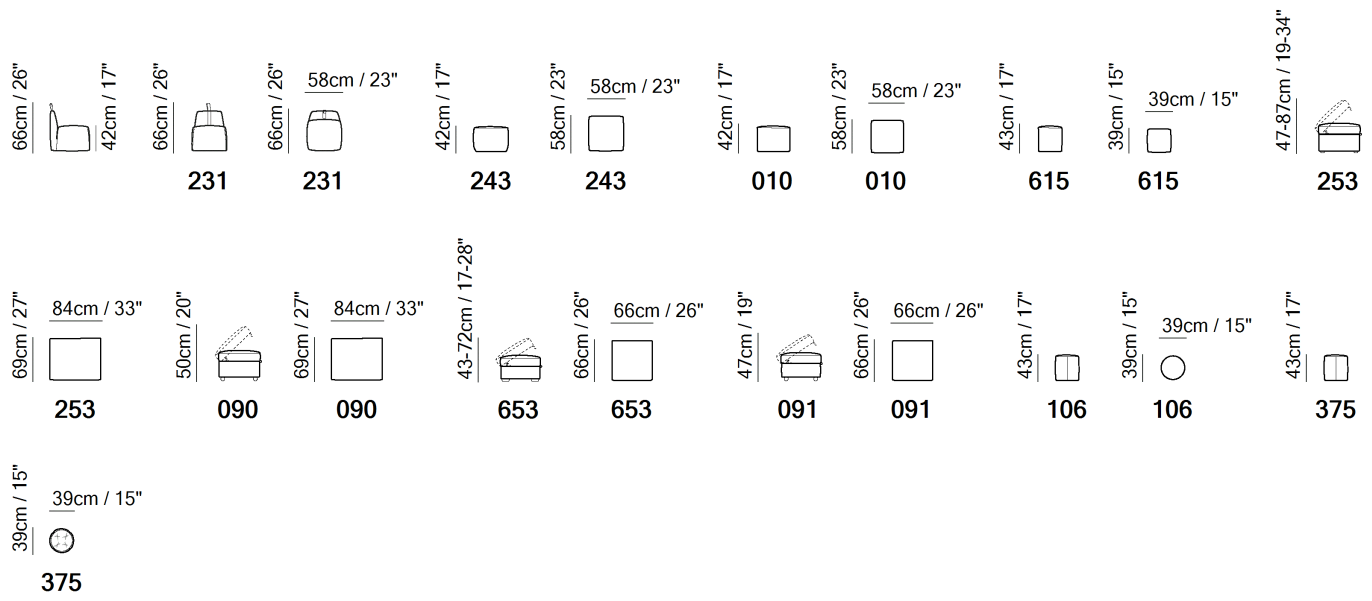

■ Vers. 179+231

SCHEMATICS



TECHNICAL INFORMATION

	<b>COVERING</b>	Leather <input checked="" type="checkbox"/>	Soft Cover <input checked="" type="checkbox"/>				
	<b>FILLING</b>	Arms	<input type="checkbox"/> Fiber <input checked="" type="checkbox"/> Foam <input type="checkbox"/> Feather/Fiber Mix <input type="checkbox"/> Feather	Seat cushion	<input type="checkbox"/> Fiber <input checked="" type="checkbox"/> Foam <input type="checkbox"/> Feather/Fiber Mix <input type="checkbox"/> Feather	Back cushion	<input type="checkbox"/> Fiber <input checked="" type="checkbox"/> Foam <input type="checkbox"/> Feather/Fiber Mix <input type="checkbox"/> Feather
	<b>COMFORT</b>	Firm Comfort <input checked="" type="checkbox"/>	Standard Comfort <input checked="" type="checkbox"/>				
	<b>FUNCTION</b>	Bed <input type="checkbox"/>	Electric motion <input type="checkbox"/>	Motion <input type="checkbox"/>	Recliner <input type="checkbox"/>	Sliding <input type="checkbox"/>	
	<b>LEGS</b>	Metal <input type="checkbox"/>	Wood <input type="checkbox"/>	Castors <input type="checkbox"/>	Plastic <input checked="" type="checkbox"/>	Upholstered <input type="checkbox"/>	

NOTES

- Contrast stitching is available only with certain covers and option is managed directly in NARES (vers. 453-541-545).
- Contrast welt is available to be managed as 1° COV: contrast welt - 2° COV: ottoman (vers. 405-543).
- Version 177: Small round ottoman with castors
- Vers. 231 available only in fabric with contrast leather or fabric belt, handle and piping option.
- Version 243: Small assymmetric cube shaped ottoman is available with contrast welt; second cover (welt) is always Le Mans both for leather and fabric.
- Version 253: Small rectangular ottoman available with storage; opening with pistons
- Version 345: Second option version of 405, large round ottoman with studs around the base
- Version 405: Large round ottoman available with contrast welt option
- Version 453: Large square ottoman with storage (available only as second option)
- Version 541: Large rectangular ottoman with a quilted cushion top
- Version 543: Large square ottoman available with contrast welt option
- Version 545: Large round ottoman with a quilted cushion top (not available in EMEAI)
- Version 546: Second option version of 543, large square ottoman with studs around the base
- Version 653: Small square ottoman available with storage; opening with pistons
- Tight Seat Cushion (the seat cushions of the models are fixed to the frame)
- Internal wooden frame.
- Feet will be in a bag inside the package and requires assembling.
- The model will be wrapped in a plastic bag.

## NOTES

---

- Versions 042 - 090/091 - 104 - 177 - 179 - 453 have castors as feet.
- Feet height 3,0 cm
- Version 231 to be ordered in two coverings:
- 1st covering: ottoman in fabric
- 2nd covering: belt, handle and piping in leather (Le Mans only) or in fabric, same category as the 1st covering



■ Vers. 178



■ Vers. 178





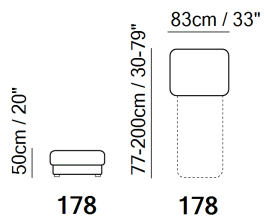

■ Vers. 178

SCHEMATICS

---



TECHNICAL INFORMATION

	<b>COVERING</b>	Soft Cover <input checked="" type="checkbox"/>					
	<b>FILLING</b>	Arms	<input type="checkbox"/> Fiber <input type="checkbox"/> Foam <input type="checkbox"/> Feather/Fiber Mix <input type="checkbox"/> Feather	Seat cushion	<input type="checkbox"/> Fiber <input type="checkbox"/> Foam <input type="checkbox"/> Feather/Fiber Mix <input type="checkbox"/> Feather	Back cushion	<input type="checkbox"/> Fiber <input type="checkbox"/> Foam <input type="checkbox"/> Feather/Fiber Mix <input type="checkbox"/> Feather
	<b>COMFORT</b>	Standard Comfort <input checked="" type="checkbox"/>	Firm Comfort <input type="checkbox"/>				
	<b>FUNCTION</b>	Bed <input type="checkbox"/>	Electric motion <input type="checkbox"/>	Motion <input type="checkbox"/>	Recliner <input type="checkbox"/>	Sliding <input type="checkbox"/>	
	<b>LEGS</b>	Wood <input type="checkbox"/>	Metal <input type="checkbox"/>	Upholstered <input type="checkbox"/>	Plastic <input type="checkbox"/>	Castors <input type="checkbox"/>	

NOTES

NOTES

---



■ Vers. 072+229+001+002



■ Vers. 072+229+001+002



■ Vers. 000+001+229+073



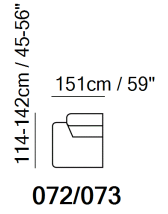
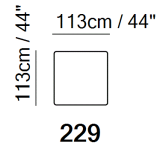
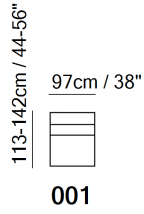
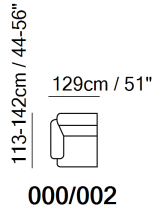

SCHEMATICS

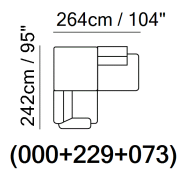
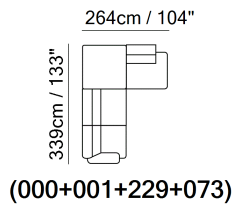

COMPOSITION EXAMPLES



**TECHNICAL INFORMATION**

	<b>COVERING</b>	Leather <input checked="" type="checkbox"/>	Soft Cover <input checked="" type="checkbox"/>			
	<b>FILLING</b>	Arms <input type="checkbox"/> Fiber <input checked="" type="checkbox"/> Foam <input type="checkbox"/> Feather/Fiber Mix <input type="checkbox"/> Feather	Seat cushion <input type="checkbox"/> Fiber <input checked="" type="checkbox"/> Foam <input type="checkbox"/> Feather/Fiber Mix <input type="checkbox"/> Feather	Back cushion <input type="checkbox"/> Fiber <input checked="" type="checkbox"/> Foam <input type="checkbox"/> Feather/Fiber Mix <input type="checkbox"/> Feather		
	<b>COMFORT</b>	Firm Comfort <input type="checkbox"/>	Standard Comfort <input checked="" type="checkbox"/>			
	<b>FUNCTION</b>	Bed <input type="checkbox"/>	Electric motion <input type="checkbox"/>	Motion <input type="checkbox"/>	Recliner <input type="checkbox"/>	Sliding <input type="checkbox"/>
	<b>LEGS</b>	Metal <input checked="" type="checkbox"/>	Wood <input type="checkbox"/>	Castors <input type="checkbox"/>	Plastic <input type="checkbox"/>	Upholstered <input type="checkbox"/>

**NOTES**

- LEATHER: Model available only in Top Grain leather
- Contrast stitching is available only with certain covers and option is managed directly in NARES.
- The model has adjustable backrest: 2 positions, back and forth
- Model has manual adjustable arms.
- Tight Seat Cushion (the seat cushions of the models are fixed to the frame)
- Tight Back Cushion (the back cushions of the models are fixed to the frame)
- With Leather Side (the sectional pieces come with leather sides)
- Internal wooden frame.
- Feet will be in a bag inside the package and requires assembling.
- Feet available in metal finishings 77 (Glossy Chromed) / 79 (Matte Black)
- Feet height 13,0 cm

NOTES

---



■ Vers. 064



■ Vers. 446



■ Vers. 182+221+207



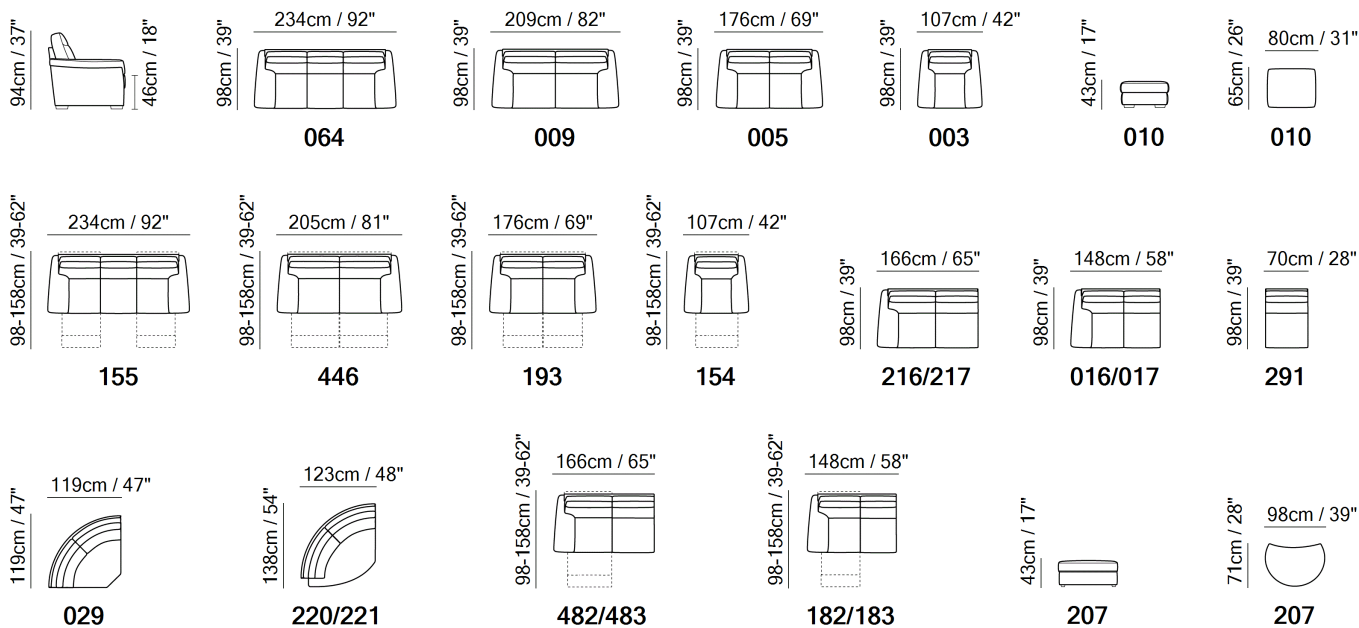

SCHEMATICS

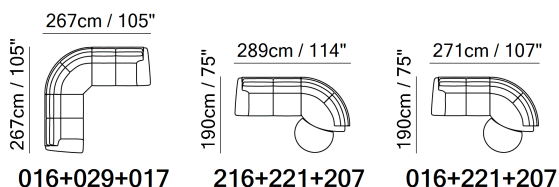

COMPOSITION EXAMPLES



TECHNICAL INFORMATION

	<b>COVERING</b>	Leather <input checked="" type="checkbox"/>	Soft Cover <input checked="" type="checkbox"/>			
	<b>FILLING</b>	Arms <input type="checkbox"/> Fiber <input checked="" type="checkbox"/> Foam <input type="checkbox"/> Feather/Fiber Mix <input type="checkbox"/> Feather	Seat cushion <input type="checkbox"/> Fiber <input checked="" type="checkbox"/> Foam <input type="checkbox"/> Feather/Fiber Mix <input type="checkbox"/> Feather	Back cushion <input checked="" type="checkbox"/> Fiber <input type="checkbox"/> Foam <input type="checkbox"/> Feather/Fiber Mix <input type="checkbox"/> Feather		
	<b>COMFORT</b>	Standard Comfort <input checked="" type="checkbox"/>	Firm Comfort <input checked="" type="checkbox"/>			
	<b>FUNCTION</b>	Bed <input type="checkbox"/>	Electric motion <input checked="" type="checkbox"/>	Motion <input checked="" type="checkbox"/>	Recliner <input checked="" type="checkbox"/>	Sliding <input type="checkbox"/>
	<b>LEGS</b>	Wood <input checked="" type="checkbox"/>	Metal <input type="checkbox"/>	Upholstered <input type="checkbox"/>	Plastic <input type="checkbox"/>	Castors <input type="checkbox"/>

BED MECHANISM & MATTRESS

MECHANISM		MATTRESS		
VERSIONS	TYPE	VERSIONS	TYPE	DIMENSIONS
264	Electro-welded - Double folding	264	GREENPLUS	W L H 140 193 14

**GREENPLUS** GREENPLUS mattress is a patented, innovative product. It is ecological, made up of microporous elastomers. It has a great adaptation capacity to the various body pressure which gives big support to the spine. It is antibacterial and no-allergic.

NOTES

- Stitching on model is based on the color of the welt; even on versions without welt (i.e. pouf, corner, armless chair) the second covering needs to be entered in Nares so that the stitching will be the same as the rest of the sofa.
- The model has external soft touch buttons on the arm to activate the mechanism.
- Version 010 ottoman is available only with comfort standard.
- A battery pack can be ordered with its own version code 830. For order entry please use XX for category and XXX for cover code. In order to optimize the duration of the battery, it is suggested to order one per each motion seat.
- All arms, back and seat surfaces are covered in Top Grain.
- This model is available with split leather exterior covering (Side, Rear and Front Panels)
- Tight Seat Cushion (the seat cushions of the models are fixed to the frame)
- Tight Back Cushion (the back cushions of the models are fixed to the frame)
- No Leather/Fabric Side (the sectional pieces have the side covered with lining and not leather nor fabric)
- Internal wooden frame.
- Feet will be in a bag inside the package and requires assembling.
- The model will be wrapped in a plastic bag.

## NOTES

---

- Feet available in wood finishings 09 (Walnut) / 18 (Wengè)
- Feet height 4,0 cm



■ Vers. 009



■ Vers. 446



■ Vers. 182+201



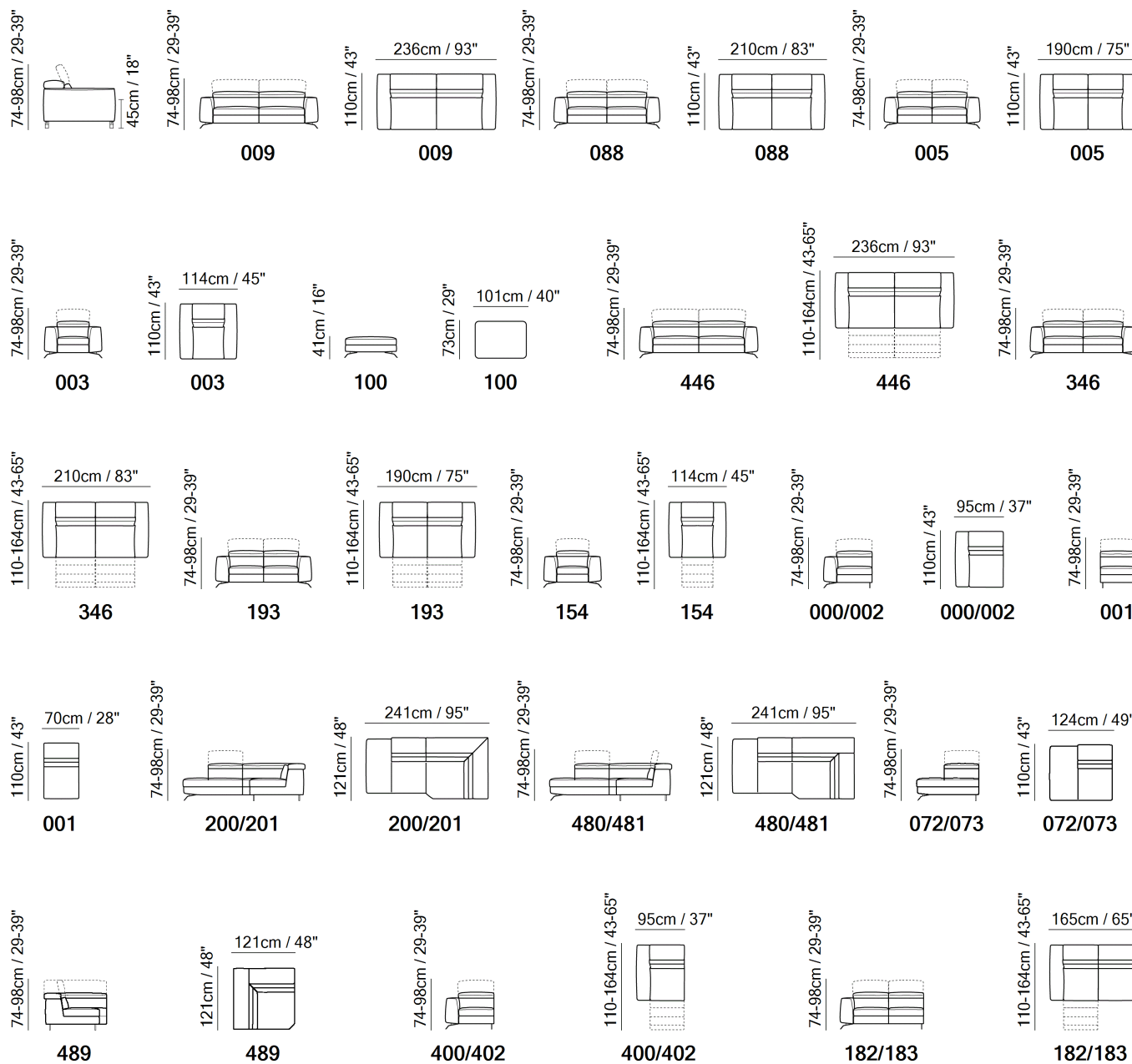

SCHEMATICS

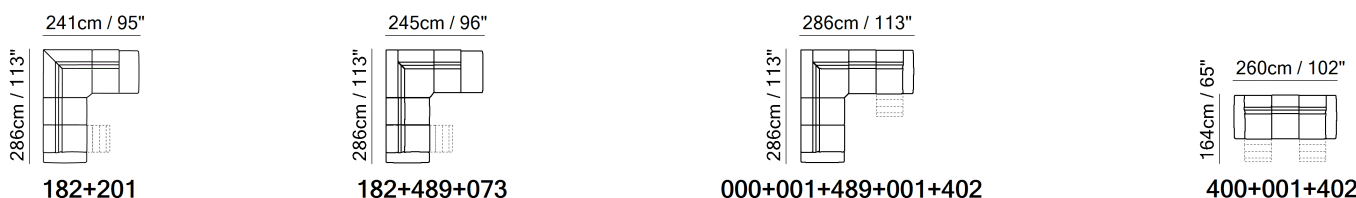

COMPOSITION EXAMPLES



TECHNICAL INFORMATION

	<b>COVERING</b>	Leather <input checked="" type="checkbox"/>	Soft Cover <input checked="" type="checkbox"/>				
	<b>FILLING</b>	Arms	<input type="checkbox"/> Fiber <input checked="" type="checkbox"/> Foam <input type="checkbox"/> Feather/Fiber Mix <input type="checkbox"/> Feather	Seat cushion	<input type="checkbox"/> Fiber <input checked="" type="checkbox"/> Foam <input type="checkbox"/> Feather/Fiber Mix <input type="checkbox"/> Feather	Back cushion	<input type="checkbox"/> Fiber <input checked="" type="checkbox"/> Foam <input type="checkbox"/> Feather/Fiber Mix <input type="checkbox"/> Feather
	<b>COMFORT</b>	Firm Comfort <input checked="" type="checkbox"/>	Standard Comfort <input checked="" type="checkbox"/>				
	<b>FUNCTION</b>	Bed <input type="checkbox"/>	Electric motion <input checked="" type="checkbox"/>	Motion <input checked="" type="checkbox"/>	Recliner <input checked="" type="checkbox"/>	Sliding <input type="checkbox"/>	
	<b>VISUAL APPEARANCE*</b>	Low <input checked="" type="checkbox"/>	Medium <input type="checkbox"/>	High <input type="checkbox"/>			
	<b>LEGS</b>	Metal <input checked="" type="checkbox"/>	Wood <input type="checkbox"/>	Castors <input type="checkbox"/>	Plastic <input type="checkbox"/>	Upholstered <input type="checkbox"/>	

VISUAL APPEARANCE

The product may reveal various wrinkles due to the combination of Elasticity of the covering, characteristics of the interior construction and the design of the product.



Products with Visual Appearance listed as High or Medium would require higher degree of care, where seats and back cushions may require fluffing and plumping more often than Products with Visual Appearance listed as Low.

NOTES

- Available in leather or fabric.
- Contrast stitching is available only with certain covers and option is managed directly in NARES.
- Dual power mechanism: The model has 4 buttons inside the arm to activate - independently - the headrest and footrest.
- Second option versions 480/481 have 2 adjustable headrests on the left and right terminal backs
- Second option version corner 489 has both headrests adjustable.
- A battery pack can be ordered with its own version code 830. For order entry please use XX for category and XXX for cover code. In order to optimize the duration of the battery, it is suggested to order one per each motion seat.
- All arms, back and seat surfaces are covered in Top Grain.
- This model is available with split leather exterior covering (Side, Rear and Front Panels)
- Tight Seat Cushion (the seat cushions of the models are fixed to the frame)
- Tight Back Cushion (the back cushions of the models are fixed to the frame)
- Internal wooden frame.
- Feet will be in a bag inside the package and requires assembling.

## NOTES

---

- Packaging: plastic wrap for stationary versions and cardboard box for motion/sofabed versions
- Feet available in metal finishings 77 (Glossy Chromed) / 79 (Matte Black)
- Feet height 14,0 cm



■ Vers. T66



■ Vers. T66



■ Vers. 450+291+011+291+291+049



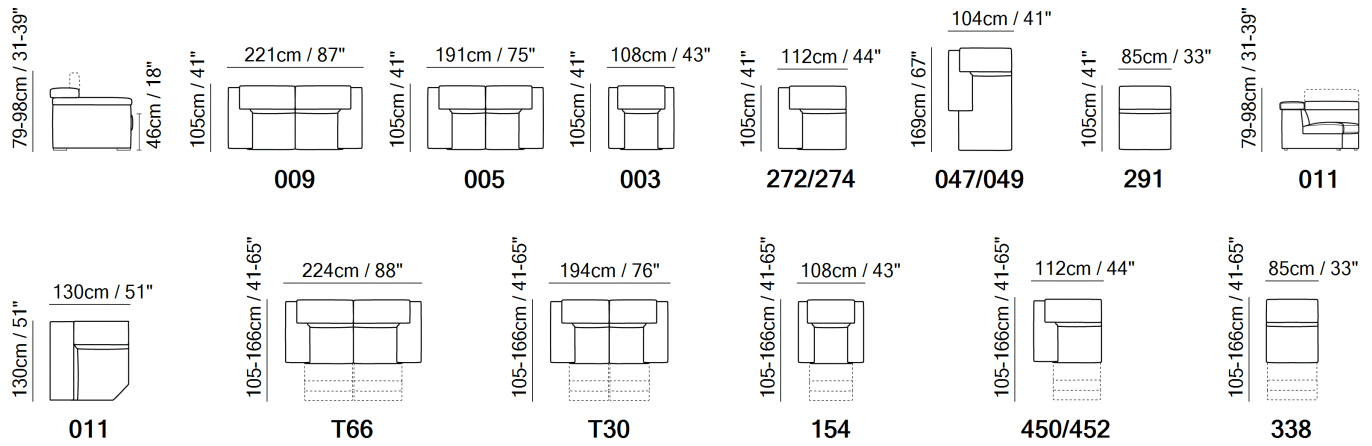

SCHEMATICS

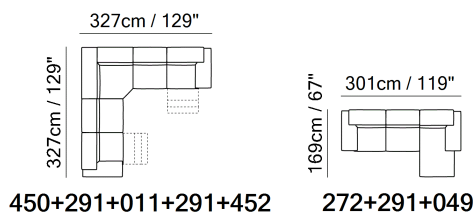

COMPOSITION EXAMPLES



**TECHNICAL INFORMATION**

	<b>COVERING</b>	Leather <input checked="" type="checkbox"/>	Soft Cover <input checked="" type="checkbox"/>			
	<b>FILLING</b>	Arms <input type="checkbox"/> Fiber <input checked="" type="checkbox"/> Foam <input type="checkbox"/> Feather/Fiber Mix <input type="checkbox"/> Feather	Seat cushion <input type="checkbox"/> Fiber <input checked="" type="checkbox"/> Foam <input type="checkbox"/> Feather/Fiber Mix <input type="checkbox"/> Feather	Back cushion <input type="checkbox"/> Fiber <input checked="" type="checkbox"/> Foam <input type="checkbox"/> Feather/Fiber Mix <input type="checkbox"/> Feather		
	<b>COMFORT</b>	Standard Comfort <input checked="" type="checkbox"/>	Firm Comfort <input checked="" type="checkbox"/>			
	<b>FUNCTION</b>	Bed <input type="checkbox"/>	Electric motion <input checked="" type="checkbox"/>	Motion <input checked="" type="checkbox"/>	Recliner <input checked="" type="checkbox"/>	Sliding <input type="checkbox"/>
	<b>LEGS</b>	Wood <input checked="" type="checkbox"/>	Metal <input type="checkbox"/>	Upholstered <input type="checkbox"/>	Plastic <input type="checkbox"/>	Castors <input type="checkbox"/>

**NOTES**

- Contrast stitching is available only with certain covers and option is managed directly in NARES.
- The model has external soft touch buttons on the arm to activate the mechanism.
- Model has power combined headrest. ATTENTION! The headrest opens first followed by the footrest.
- All arms, back and seat surfaces are covered in Top Grain.
- This model is available with split leather exterior covering (Side, Rear and Front Panels)
- Tight Seat Cushion (the seat cushions of the models are fixed to the frame)
- Tight Back Cushion (the back cushions of the models are fixed to the frame)
- Internal wooden frame.
- Feet will be in a bag inside the package and requires assembling.
- The model will be wrapped in a plastic bag.
- Feet available in wood finishings 09 (Walnut) / 18 (Wengè)

NOTES

---



■ Vers. 239



■ Vers. 233



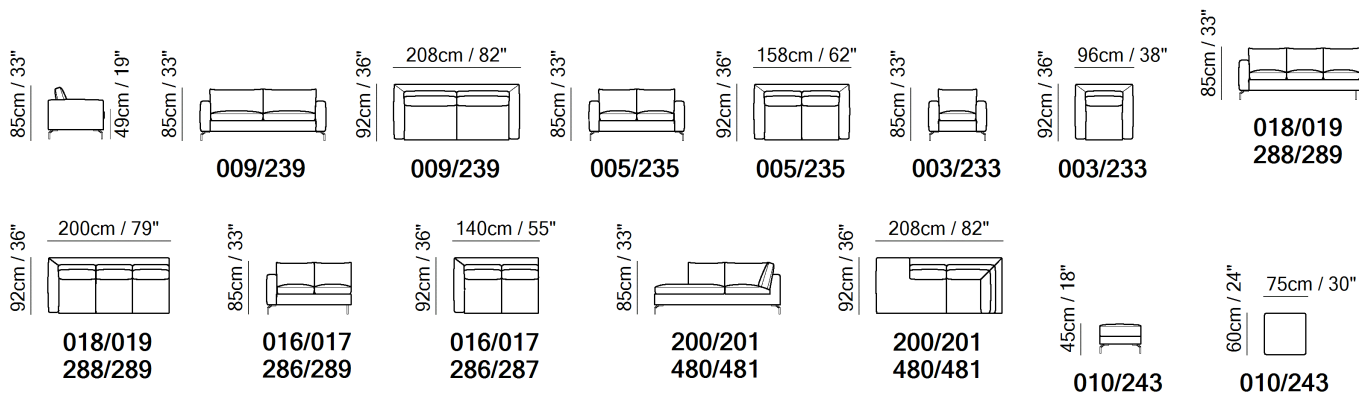

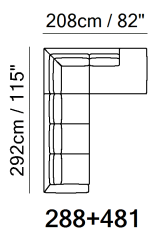

**SCHEMATICS**



**COMPOSITION EXAMPLES**



TECHNICAL INFORMATION

	<b>COVERING</b>	Leather <input checked="" type="checkbox"/>	Soft Cover <input checked="" type="checkbox"/>			
	<b>FILLING</b>	Arms <input type="checkbox"/> Fiber <input checked="" type="checkbox"/> Foam <input type="checkbox"/> Feather/Fiber Mix <input type="checkbox"/> Feather	Seat cushion <input type="checkbox"/> Fiber <input checked="" type="checkbox"/> Foam <input type="checkbox"/> Feather/Fiber Mix <input type="checkbox"/> Feather	Back cushion <input checked="" type="checkbox"/> Fiber <input type="checkbox"/> Foam <input type="checkbox"/> Feather/Fiber Mix <input type="checkbox"/> Feather		
	<b>COMFORT</b>	Firm Comfort <input checked="" type="checkbox"/>	Standard Comfort <input checked="" type="checkbox"/>			
	<b>FUNCTION</b>	Bed <input type="checkbox"/>	Electric motion <input type="checkbox"/>	Motion <input type="checkbox"/>	Recliner <input type="checkbox"/>	Sliding <input type="checkbox"/>
	<b>VISUAL APPEARANCE*</b>	Low <input checked="" type="checkbox"/>	Medium <input type="checkbox"/>	High <input type="checkbox"/>		
	<b>LEGS</b>	Metal <input checked="" type="checkbox"/>	Wood <input checked="" type="checkbox"/>	Castors <input type="checkbox"/>	Plastic <input type="checkbox"/>	Upholstered <input type="checkbox"/>

VISUAL APPEARANCE

The product may reveal various wrinkles due to the combination of Elasticity of the covering, characteristics of the interior construction and the design of the product.



Products with Visual Appearance listed as High or Medium would require higher degree of care, where seats and back cushions may require fluffing and plumping more often than Products with Visual Appearance listed as Low.

NOTES

- Available in leather or fabric.
- Contrast stitching is available only with certain covers and option is managed directly in NARES.
- All arms, back and seat surfaces are covered in Top Grain.
- This model is available with split leather exterior covering (Side, Rear and Front Panels)
- Tight Seat Cushion (the seat cushions of the models are fixed to the frame)
- Back Cushion Zippered (the back cushion is attached to the frame through a zipper)
- No Leather/Fabric Side (the sectional pieces have the side covered with lining and not leather nor fabric)
- Internal wooden frame.
- Feet will be in a bag inside the package and requires assembling.
- The model will be wrapped in a plastic bag.
- Second option versions have feet available in metal finishing 75 (Glazed Nickel) / 79 (Matte Black)
- Feet height 14,5 cm

NOTES

---



■ Vers. 544



■ Vers. 544





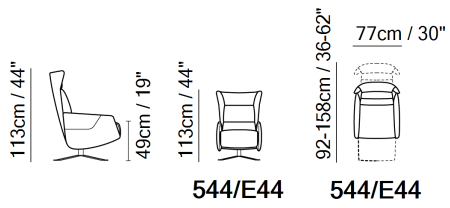

■ Vers. 544

SCHEMATICS

---



TECHNICAL INFORMATION

	<b>COVERING</b>	Leather <input checked="" type="checkbox"/>					
	<b>FILLING</b>	Arms	<input type="checkbox"/> Fiber <input checked="" type="checkbox"/> Foam <input type="checkbox"/> Feather/Fiber Mix <input type="checkbox"/> Feather	Seat cushion	<input type="checkbox"/> Fiber <input checked="" type="checkbox"/> Foam <input type="checkbox"/> Feather/Fiber Mix <input type="checkbox"/> Feather	Back cushion	<input type="checkbox"/> Fiber <input checked="" type="checkbox"/> Foam <input type="checkbox"/> Feather/Fiber Mix <input type="checkbox"/> Feather
	<b>COMFORT</b>	Standard Comfort	<input checked="" type="checkbox"/> Firm Comfort <input type="checkbox"/>				
	<b>FUNCTION</b>	Bed	Electric motion	Motion	Recliner	Sliding	
	<b>LEGS</b>	Wood	Metal	Upholstered	Plastic	Castors	

NOTES

- LEATHER: Model available only in Top Grain leather
- The model has external switch on the side panel to activate the mechanism.
- Versions Axx-Cxx-Dxx-Exx are available with rechargeable battery pack. There is a power cord outlet with a finish grommet on the lower back of the sofa rather than the bottom. This design is such to allow for easy plug and unplug action for charging.
- A battery pack can be ordered with its own version code 830. For order entry please use XX for category and XXX for cover code. In order to optimize the duration of the battery, it is suggested to order one per each motion seat.
- Tight Seat Cushion (the seat cushions of the models are fixed to the frame)
- Tight Back Cushion (the back cushions of the models are fixed to the frame)
- Internal wooden frame.
- Packaging: Cardboard wrap.
- Metal base available in unique metal finishing anthracite.
- Feet height 17,0 cm

NOTES

---



■ Vers. 446



■ Vers. 450+291+189



■ Vers. 272+076+338+452



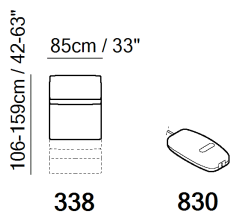
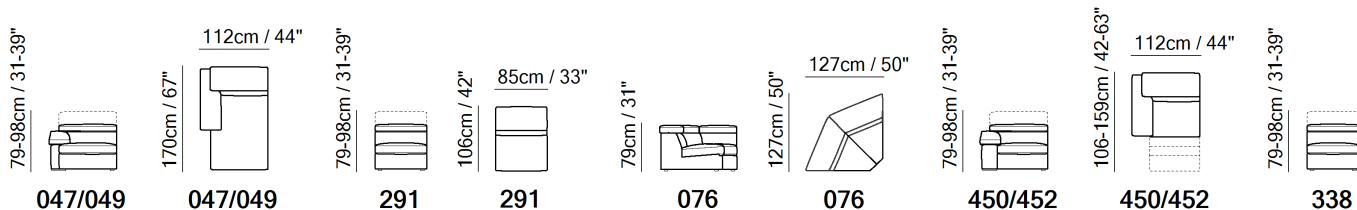
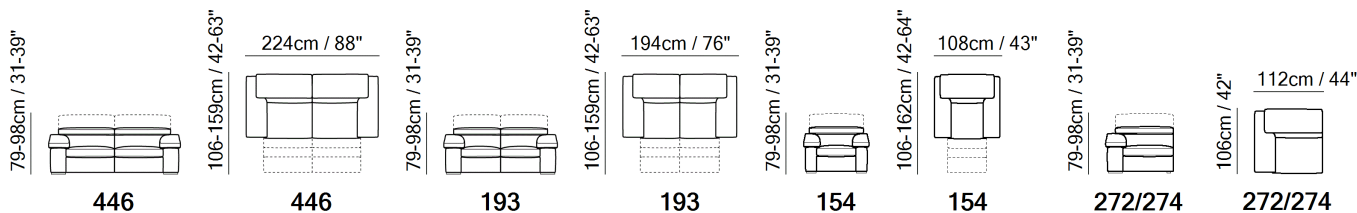
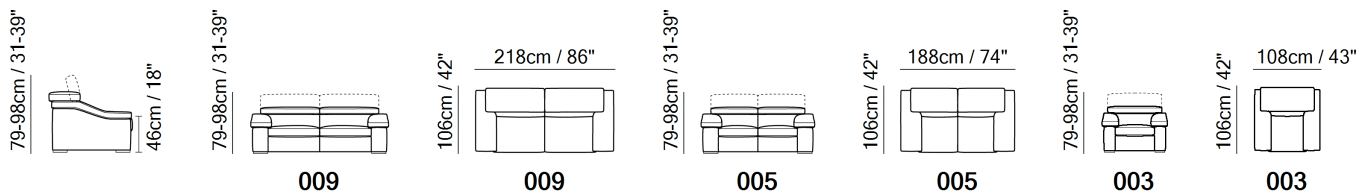

SCHEMATICS

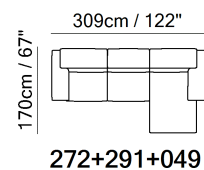
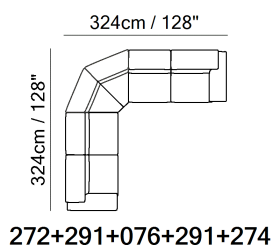
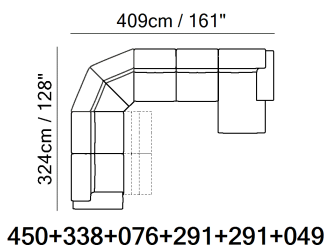

COMPOSITION EXAMPLES



TECHNICAL INFORMATION

	<b>COVERING</b>	Leather <input checked="" type="checkbox"/>	Soft Cover <input checked="" type="checkbox"/>				
	<b>FILLING</b>	Arms	<input type="checkbox"/> Fiber <input checked="" type="checkbox"/> Foam <input type="checkbox"/> Feather/Fiber Mix <input type="checkbox"/> Feather	Seat cushion	<input type="checkbox"/> Fiber <input checked="" type="checkbox"/> Foam <input type="checkbox"/> Feather/Fiber Mix <input type="checkbox"/> Feather	Back cushion	<input type="checkbox"/> Fiber <input checked="" type="checkbox"/> Foam <input type="checkbox"/> Feather/Fiber Mix <input type="checkbox"/> Feather
	<b>COMFORT</b>	Firm Comfort <input checked="" type="checkbox"/>	Standard Comfort <input checked="" type="checkbox"/>				
	<b>FUNCTION</b>	Bed <input type="checkbox"/>	Electric motion <input checked="" type="checkbox"/>	Motion <input checked="" type="checkbox"/>	Recliner <input checked="" type="checkbox"/>	Sliding <input type="checkbox"/>	
	<b>LEGS</b>	Metal <input type="checkbox"/>	Wood <input checked="" type="checkbox"/>	Castors <input type="checkbox"/>	Plastic <input type="checkbox"/>	Upholstered <input type="checkbox"/>	

NOTES

- Contrast stitching is available only with certain covers and option is managed directly in NARES.
- The model has internal soft touch buttons on the seat to activate the mechanism.
- Model has power combined headrest. ATTENTION! The headrest opens first followed by the footrest.
- Stationary versions have manually adjustable headrests.
- Tight Seat Cushion (the seat cushions of the models are fixed to the frame)
- Tight Back Cushion (the back cushions of the models are fixed to the frame)
- Internal wooden frame.
- Feet will be in a bag inside the package and requires assembling.
- The model will be wrapped in a plastic bag.
- Feet available in wood finishings 09 (Walnut) / 18 (Wengè)
- Feet height 3,5 cm

**NOTES**

---



■ Vers. 003



■ Vers. 003





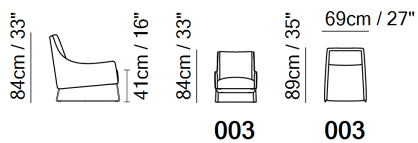

■ Vers. 003

SCHEMATICS

---



**TECHNICAL INFORMATION**

	<b>COVERING</b>	Mix <input checked="" type="checkbox"/>	Leather <input checked="" type="checkbox"/>	Soft Cover <input checked="" type="checkbox"/>		
	<b>FILLING</b>	Arms <input type="checkbox"/> Fiber <input checked="" type="checkbox"/> Foam <input type="checkbox"/> Feather/Fiber Mix <input type="checkbox"/> Feather	Seat cushion <input type="checkbox"/> Fiber <input checked="" type="checkbox"/> Foam <input type="checkbox"/> Feather/Fiber Mix <input type="checkbox"/> Feather	Back cushion <input type="checkbox"/> Fiber <input checked="" type="checkbox"/> Foam <input type="checkbox"/> Feather/Fiber Mix <input type="checkbox"/> Feather		
	<b>COMFORT</b>	Standard Comfort <input checked="" type="checkbox"/>	Firm Comfort <input type="checkbox"/>			
	<b>FUNCTION</b>	Bed <input type="checkbox"/>	Electric motion <input type="checkbox"/>	Motion <input type="checkbox"/>	Recliner <input type="checkbox"/>	Sliding <input type="checkbox"/>
	<b>LEGS</b>	Wood <input type="checkbox"/> Castors <input type="checkbox"/>	Metal <input checked="" type="checkbox"/>	Metal <input checked="" type="checkbox"/>	Upholstered <input type="checkbox"/>	Plastic <input type="checkbox"/>

**NOTES**

- LEATHER: Model available only in Top Grain leather
- Leather/Fabric MIX CATEGORIES are based on the STARTING PRICE CATEGORY OF LEATHER combined with fabric = 1B (cat.15 + fabric) - 2A (cat. 20 ...) - 2B (cat. 25 ...) - 3A (cat. 30 ...)
- Tight Seat Cushion (the seat cushions of the models are fixed to the frame)
- Tight Back Cushion (the back cushions of the models are fixed to the frame)
- Internal wooden frame.
- With Feet Assembled (the model will be loaded with feet already mounted on the sofa).
- Front feet are slightly higher in respect to rear.
- Feet available in metal finishings 77 (Glossy Chromed) / 79 (Matte Black)
- Feet height 22,5 cm
- TWO TONE COVERING OPTIONS:
  - 1° COV. = Frame and welt
  - 2° COV. = Seat and back cushions
- LEATHER-FABRIC MIX COVERING OPTIONS:
  - 1° COV. (Leather) = Frame and welt
  - 2° COV. (Fabric) = Seat and back cushions

NOTES

---



■ Vers. 003



■ Vers. 003



■ Vers. 004

SCHEMATICS

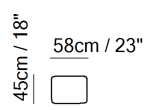
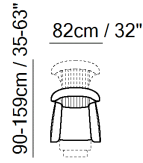
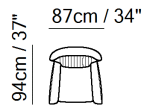

003

003





004

004

010

010

TECHNICAL INFORMATION

	<b>COVERING</b>	Leather <input checked="" type="checkbox"/>	Soft Cover <input checked="" type="checkbox"/>				
	<b>FILLING</b>	Arms	<input type="checkbox"/> Fiber <input checked="" type="checkbox"/> Foam <input type="checkbox"/> Feather/Fiber Mix <input type="checkbox"/> Feather	Seat cushion	<input type="checkbox"/> Fiber <input checked="" type="checkbox"/> Foam <input type="checkbox"/> Feather/Fiber Mix <input type="checkbox"/> Feather	Back cushion	<input type="checkbox"/> Fiber <input checked="" type="checkbox"/> Foam <input type="checkbox"/> Feather/Fiber Mix <input type="checkbox"/> Feather
	<b>COMFORT</b>	Firm Comfort <input checked="" type="checkbox"/>	Standard Comfort <input checked="" type="checkbox"/>				
	<b>FUNCTION</b>	Bed <input type="checkbox"/>	Electric motion <input type="checkbox"/>	Motion <input type="checkbox"/>	Recliner <input checked="" type="checkbox"/>	Sliding <input type="checkbox"/>	
	<b>LEGS</b>	Metal <input type="checkbox"/>	Wood <input checked="" type="checkbox"/>	Castors <input type="checkbox"/>	Plastic <input type="checkbox"/>	Upholstered <input type="checkbox"/>	

NOTES

- Tight Seat Cushion (the seat cushions of the models are fixed to the frame)
- Tight Back Cushion (the back cushions of the models are fixed to the frame)
- Internal wooden frame.
- Feet will be in a bag inside the package and requires assembling.
- The model will be wrapped in a plastic bag.
- Feet available in wood finishings 09 (Walnut) / 18 (Wengè)
- Feet height 17,0 cm

**NOTES**

---



■ Vers. 009



■ Vers. 009



■ Vers. 003



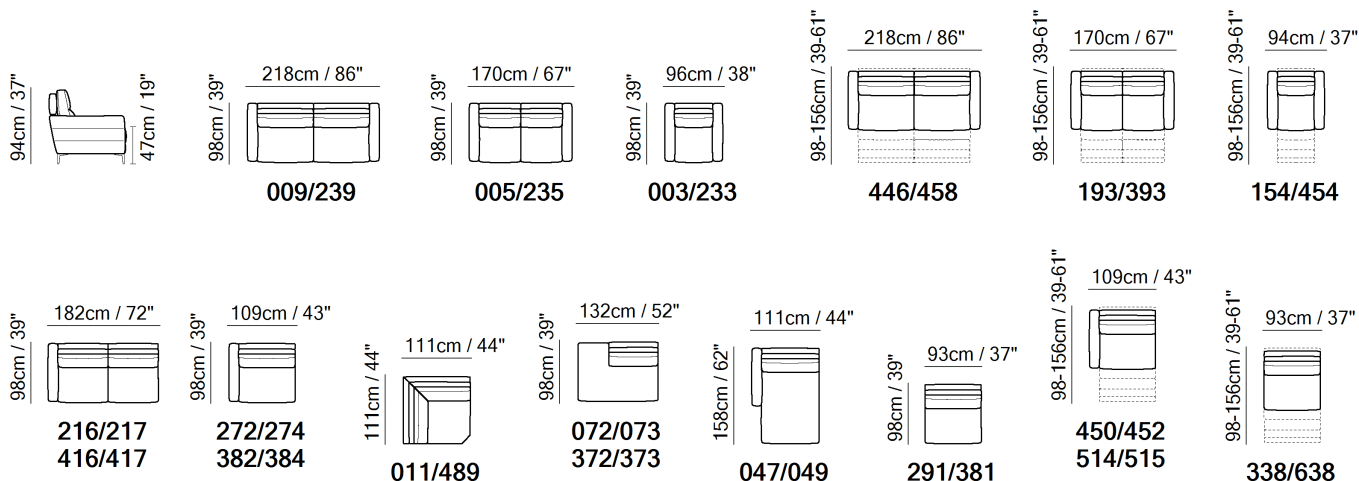

SCHEMATICS

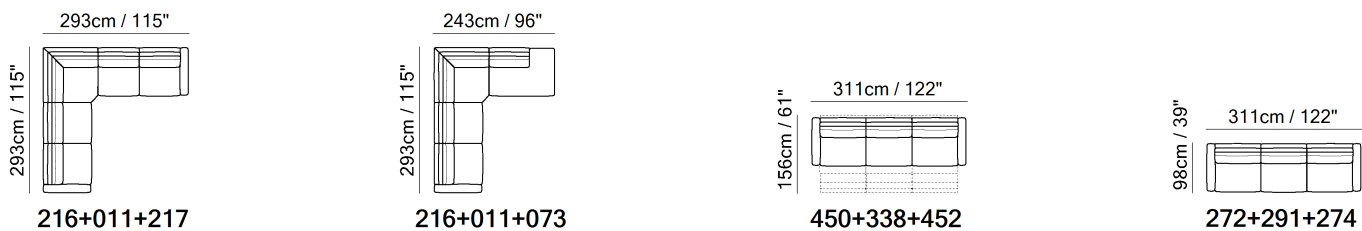

COMPOSITION EXAMPLES



TECHNICAL INFORMATION

	<b>COVERING</b>	Leather <input checked="" type="checkbox"/>	Soft Cover <input checked="" type="checkbox"/>			
	<b>FILLING</b>	Arms <input type="checkbox"/> Fiber <input checked="" type="checkbox"/> Foam <input type="checkbox"/> Feather/Fiber Mix <input type="checkbox"/> Feather	Seat cushion <input type="checkbox"/> Fiber <input checked="" type="checkbox"/> Foam <input type="checkbox"/> Feather/Fiber Mix <input type="checkbox"/> Feather	Back cushion <input type="checkbox"/> Fiber <input checked="" type="checkbox"/> Foam <input type="checkbox"/> Feather/Fiber Mix <input type="checkbox"/> Feather		
	<b>COMFORT</b>	Standard Comfort <input checked="" type="checkbox"/>	Firm Comfort <input checked="" type="checkbox"/>			
	<b>FUNCTION</b>	Bed <input type="checkbox"/>	Electric motion <input checked="" type="checkbox"/>	Motion <input checked="" type="checkbox"/>	Recliner <input checked="" type="checkbox"/>	Sliding <input type="checkbox"/>
	<b>LEGS</b>	Wood <input checked="" type="checkbox"/>	Metal <input checked="" type="checkbox"/>	Upholstered <input type="checkbox"/>	Plastic <input type="checkbox"/>	Castors <input type="checkbox"/>

NOTES

- Contrast stitching is available only with certain covers and option is managed directly in NARES.
- The model has external switch on the side panel to activate the mechanism.
- Tight Seat Cushion (the seat cushions of the models are fixed to the frame)
- Back Cushion Zippered (the back cushion is attached to the frame through a zipper)
- No Leather/Fabric Side (the sectional pieces have the side covered with lining and not leather nor fabric)
- Internal wooden frame.
- Feet will be in a bag inside the package and requires assembling.
- The model will be wrapped in a plastic bag.
- Feet available in metal finishings 77 (Glossy Chromed) / 79 (Matte Black)
- Second option versions have feet available in wood finishings 09 (Walnut) / 18 (Wengè)
- Feet height 13,0 cm

**NOTES**

---



■ Vers. 544



■ Vers. 544





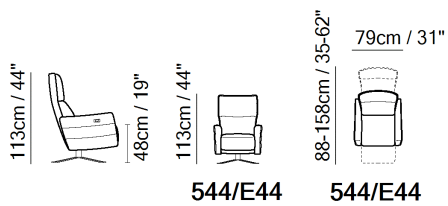

■ Vers. 544

SCHEMATICS

---



TECHNICAL INFORMATION

	<b>COVERING</b>	Leather <input checked="" type="checkbox"/>	Soft Cover <input checked="" type="checkbox"/>				
	<b>FILLING</b>	Arms	<input type="checkbox"/> Fiber <input checked="" type="checkbox"/> Foam <input type="checkbox"/> Feather/Fiber Mix <input type="checkbox"/> Feather	Seat cushion	<input type="checkbox"/> Fiber <input checked="" type="checkbox"/> Foam <input type="checkbox"/> Feather/Fiber Mix <input type="checkbox"/> Feather	Back cushion	<input type="checkbox"/> Fiber <input checked="" type="checkbox"/> Foam <input type="checkbox"/> Feather/Fiber Mix <input type="checkbox"/> Feather
	<b>COMFORT</b>	Firm Comfort <input type="checkbox"/>	Standard Comfort <input checked="" type="checkbox"/>				
	<b>FUNCTION</b>	Bed <input type="checkbox"/>	Electric motion <input type="checkbox"/>	Motion <input type="checkbox"/>	Recliner <input type="checkbox"/>	Sliding <input type="checkbox"/>	
	<b>LEGS</b>	Metal <input type="checkbox"/>	Wood <input type="checkbox"/>	Castors <input type="checkbox"/>	Plastic <input type="checkbox"/>	Upholstered <input type="checkbox"/>	

NOTES

- Available in leather or fabric.
- The model has external switch on the side panel to activate the mechanism.
- Versions Axx-Cxx-Dxx-Exx are available with rechargeable battery pack. There is a power cord outlet with a finish grommet on the lower back of the sofa rather than the bottom. This design is such to allow for easy plug and unplug action for charging.
- A battery pack can be ordered with its own version code 830. For order entry please use XX for category and XXX for cover code. In order to optimize the duration of the battery, it is suggested to order one per each motion seat.
- Tight Seat Cushion (the seat cushions of the models are fixed to the frame)
- Tight Back Cushion (the back cushions of the models are fixed to the frame)
- Internal wooden frame.
- With Feet Assembled (the model will be loaded with feet already mounted on the sofa).
- Packaging: Cardboard wrap.
- Metal base available only in anthracite finishing

NOTES

---



■ Vers. 064



■ Vers. 239



■ Vers. 100

SCHEMATICS

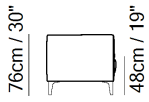

064/254

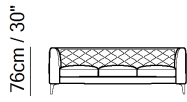

064/254

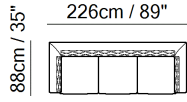

009/239

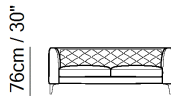

009/239

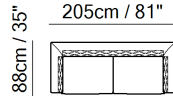

005/235



005/235

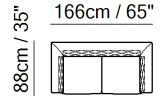





003/233

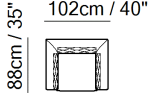

003/233



TECHNICAL INFORMATION

	<b>COVERING</b>	Leather <input checked="" type="checkbox"/>	Soft Cover <input checked="" type="checkbox"/>				
	<b>FILLING</b>	Arms	<input type="checkbox"/> Fiber <input checked="" type="checkbox"/> Foam <input type="checkbox"/> Feather/Fiber Mix <input type="checkbox"/> Feather	Seat cushion	<input type="checkbox"/> Fiber <input checked="" type="checkbox"/> Foam <input type="checkbox"/> Feather/Fiber Mix <input type="checkbox"/> Feather	Back cushion	<input type="checkbox"/> Fiber <input checked="" type="checkbox"/> Foam <input type="checkbox"/> Feather/Fiber Mix <input type="checkbox"/> Feather
	<b>COMFORT</b>	Standard Comfort <input checked="" type="checkbox"/>	Firm Comfort <input type="checkbox"/>				
	<b>FUNCTION</b>	Bed <input type="checkbox"/>	Electric motion <input type="checkbox"/>	Motion <input type="checkbox"/>	Recliner <input type="checkbox"/>	Sliding <input type="checkbox"/>	
	<b>LEGS</b>	Wood <input checked="" type="checkbox"/>	Metal <input checked="" type="checkbox"/>	Upholstered <input type="checkbox"/>	Plastic <input type="checkbox"/>	Castors <input type="checkbox"/>	

NOTES

- LEATHER: Model available only in Top Grain leather
- Loose Seat Cushion (the seat cushions of the model are not fixed to the frame)
- Tight Back Cushion (the back cushions of the models are fixed to the frame)
- Internal wooden frame.
- Feet will be in a bag inside the package and requires assembling.
- The model will be wrapped in a plastic bag.
- Feet available in wood finishings 09 (Walnut) / 18 (Wengè)
- Second option versions have feet available in lacquered metal 82 (camel), 83 (moka) and 70 (brushed brass)
- Feet height 17,0 cm

NOTES

---



■ Vers. 009



■ Vers. 239



■ Vers. 272+291+049



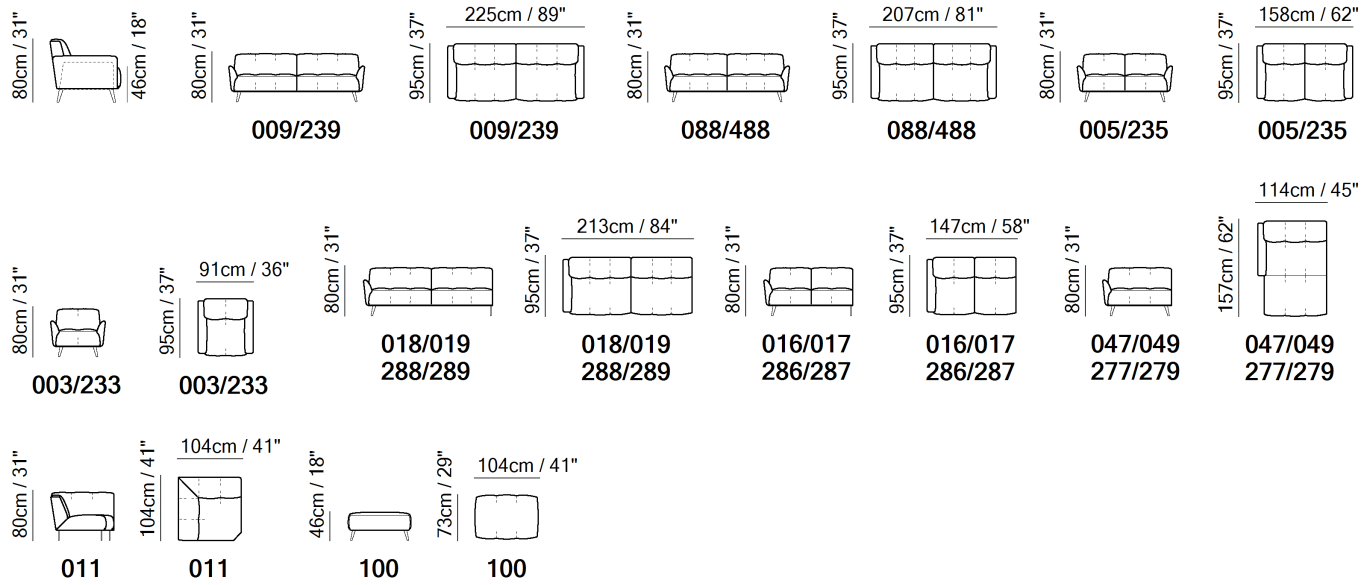

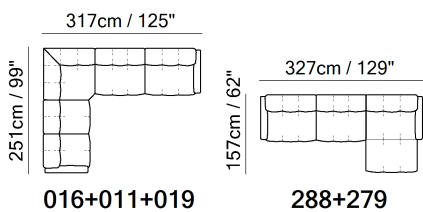

SCHEMATICS



COMPOSITION EXAMPLES



TECHNICAL INFORMATION

	<b>COVERING</b>	Leather <input checked="" type="checkbox"/>	Soft Cover <input checked="" type="checkbox"/>				
	<b>FILLING</b>	Arms	<input type="checkbox"/> Fiber <input checked="" type="checkbox"/> Foam <input type="checkbox"/> Feather/Fiber Mix <input type="checkbox"/> Feather	Seat cushion	<input type="checkbox"/> Fiber <input checked="" type="checkbox"/> Foam <input type="checkbox"/> Feather/Fiber Mix <input type="checkbox"/> Feather	Back cushion	<input type="checkbox"/> Fiber <input checked="" type="checkbox"/> Foam <input type="checkbox"/> Feather/Fiber Mix <input type="checkbox"/> Feather
	<b>COMFORT</b>	Firm Comfort <input type="checkbox"/>	Standard Comfort <input checked="" type="checkbox"/>				
	<b>FUNCTION</b>	Bed <input type="checkbox"/>	Electric motion <input type="checkbox"/>	Motion <input type="checkbox"/>	Recliner <input type="checkbox"/>	Sliding <input type="checkbox"/>	
	<b>VISUAL APPEARANCE*</b>	Low <input type="checkbox"/>	Medium <input checked="" type="checkbox"/>	High <input type="checkbox"/>			
	<b>LEGS</b>	Metal <input checked="" type="checkbox"/>	Wood <input type="checkbox"/>	Castors <input type="checkbox"/>	Plastic <input type="checkbox"/>	Upholstered <input type="checkbox"/>	

VISUAL APPEARANCE

The product may reveal various wrinkles due to the combination of Elasticity of the covering, characteristics of the interior construction and the design of the product.



Products with Visual Appearance listed as High or Medium would require higher degree of care, where seats and back cushions may require fluffing and plumping more often than Products with Visual Appearance listed as Low.

NOTES

- Available in leather (TG only) or fabric.
- In leather, model is available starting from cat. 15 (except chairs and ottoman)
- Contrast stitching is available only with certain covers and option is managed directly in NARES.
- All arms, back and seat surfaces are covered in Top Grain.
- Tight Seat Cushion (the seat cushions of the models are fixed to the frame)
- Tight Back Cushion (the back cushions of the models are fixed to the frame)
- No Leather/Fabric Side (the sectional pieces have the side covered with lining and not leather nor fabric)
- Internal wooden frame.
- Feet will be in a bag inside the package and requires assembling.
- Packaging: Cardboard wrap.
- Feet are always made of metal, the wooden effect is obtained by water transfer print.
- Standard versions are without wood panel on the external arm in three different metal feet finishings.
- Second option versions are available only with wooden panel on the arm in two different wood finishings as the feet in 09 (walnut) and 18 (wengè)

## NOTES

---

- Feet height 15,0 cm



■ Vers. 450+275+269



■ Vers. 450+275+269



■ Vers. 450+275+338+275+452



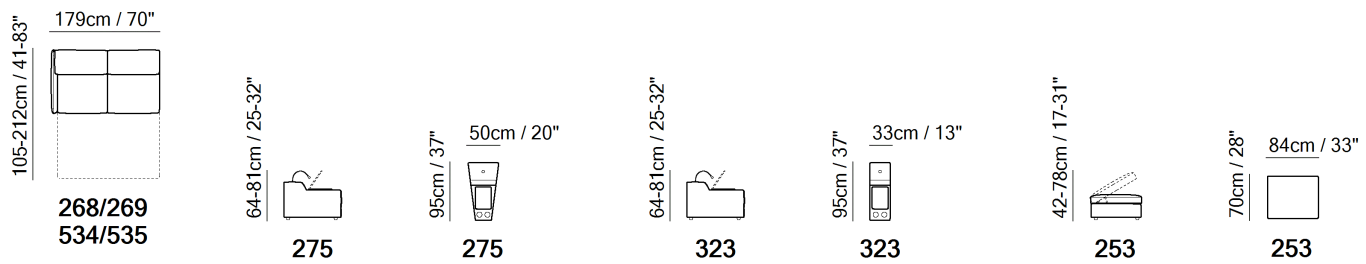
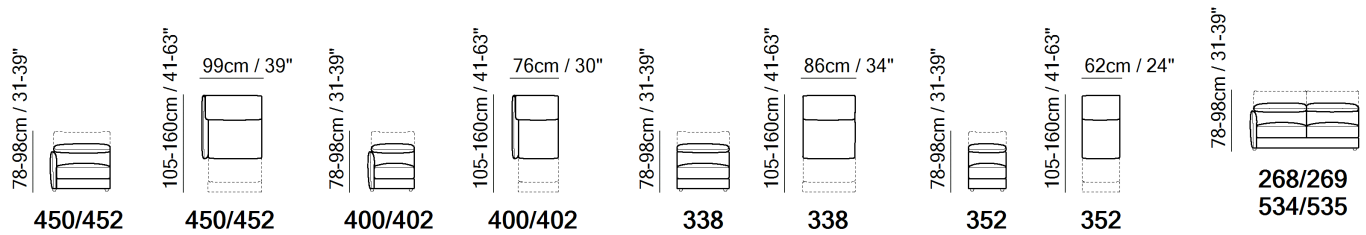
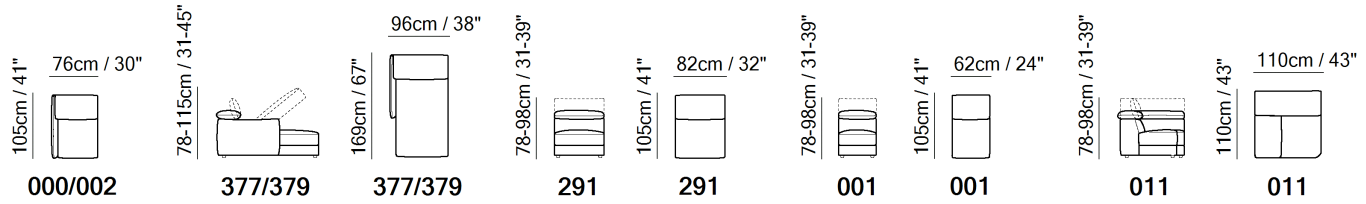
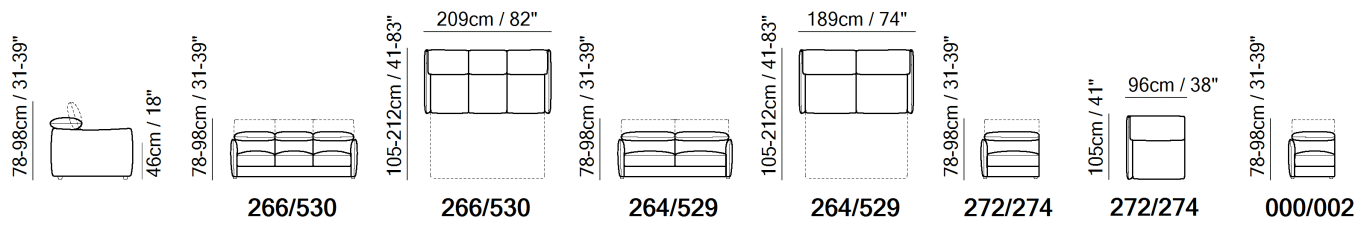

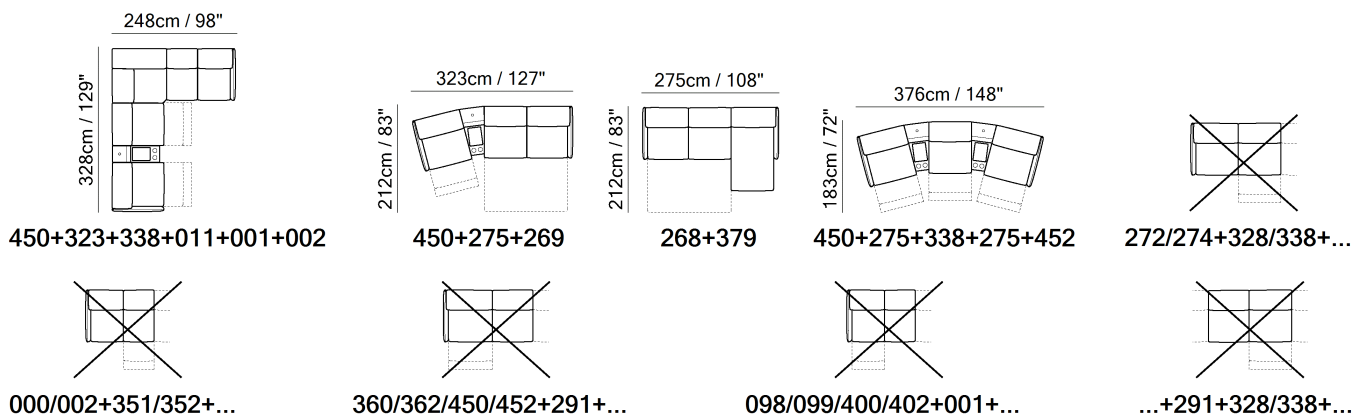

SCHEMATICS



COMPOSITION EXAMPLES



TECHNICAL INFORMATION

	<b>COVERING</b>	Leather <input checked="" type="checkbox"/>	Soft Cover <input checked="" type="checkbox"/>			
	<b>FILLING</b>	Arms <input type="checkbox"/> Fiber <input checked="" type="checkbox"/> Foam <input type="checkbox"/> Feather/Fiber Mix <input type="checkbox"/> Feather	Seat cushion <input type="checkbox"/> Fiber <input checked="" type="checkbox"/> Foam <input type="checkbox"/> Feather/Fiber Mix <input type="checkbox"/> Feather	Back cushion <input type="checkbox"/> Fiber <input checked="" type="checkbox"/> Foam <input type="checkbox"/> Feather/Fiber Mix <input type="checkbox"/> Feather		
	<b>COMFORT</b>	Standard Comfort <input checked="" type="checkbox"/>	Firm Comfort <input type="checkbox"/>			
	<b>FUNCTION</b>	Bed <input checked="" type="checkbox"/>	Electric motion <input checked="" type="checkbox"/>	Motion <input checked="" type="checkbox"/>	Recliner <input type="checkbox"/>	Sliding <input type="checkbox"/>
	<b>VISUAL APPEARANCE*</b>	Low <input checked="" type="checkbox"/>	Medium <input type="checkbox"/>	High <input type="checkbox"/>		
	<b>LEGS</b>	Wood <input type="checkbox"/>	Metal <input type="checkbox"/>	Upholstered <input type="checkbox"/>	Plastic <input checked="" type="checkbox"/>	Castors <input type="checkbox"/>

VISUAL APPEARANCE

The product may reveal various wrinkles due to the combination of Elasticity of the covering, characteristics of the interior construction and the design of the product.



Products with Visual Appearance listed as High or Medium would require higher degree of care, where seats and back cushions may require fluffing and plumping more often than Products with Visual Appearance listed as Low.

BED MECHANISM & MATTRESS

MECHANISM		MATTRESS		
VERSIONS	TYPE	VERSIONS	TYPE	DIMENSIONS
268,269,534,535	Ready-Bed electro-welded - Double folding	264,268,269	GREENPLUS	W L H 140 195 11
264,529	Ready-Bed electro-welded - Double folding	529,534,535	Memory	140 195 11
266,530	Ready-Bed electro-welded - Double folding	266	GREENPLUS	160 195 11
		530	Memory	160 195 11

**Ready-Bed electro-welded** The back cushion goes under the bed mechanism.  
**GREENPLUS** GREENPLUS mattress is a patented, innovative product. It is ecological, made up of microporous elastomers. It has a great adaptation capacity to the various body pressure which gives big support to the spine. It is antibacterial and no-allergic.  
**Memory** Non-allergic memory mattress available with zippered cover that can be easily taken off and washed.

NOTES

- Available in leather or fabric.
- Model is available with contrast welt (or any another decorative detail such as a band under arm cushion) to be entered as second covering in the same category.
- FABRIC: In fabric contrast welt (or any another decorative detail such as a band under arm cushion) can be made either in same category fabric or in leather with any color of Le Mans (only).
- Single power mechanism with internal switch on the seat cushion side that activates the recliner while the headrest is manually adjustable.
- Stationary versions have manually adjustable headrests.

NOTES

---

- A battery pack can be ordered with its own version code 830. For order entry please use XX for category and XXX for cover code. In order to optimize the duration of the battery, it is suggested to order one per each motion seat.
- Tight Seat Cushion (the seat cushions of the models are fixed to the frame)
- Tight Back Cushion (the back cushions of the models are fixed to the frame)
- No Leather/Fabric Side (the sectional pieces have the side covered with lining and not leather nor fabric)
- Internal wooden frame.
- Feet will be in a bag inside the package and requires assembling.
- Packaging: Cardboard wrap.
- Feet height 3,5 cm



■ Vers. 064



■ Vers. 009



■ Vers. 048



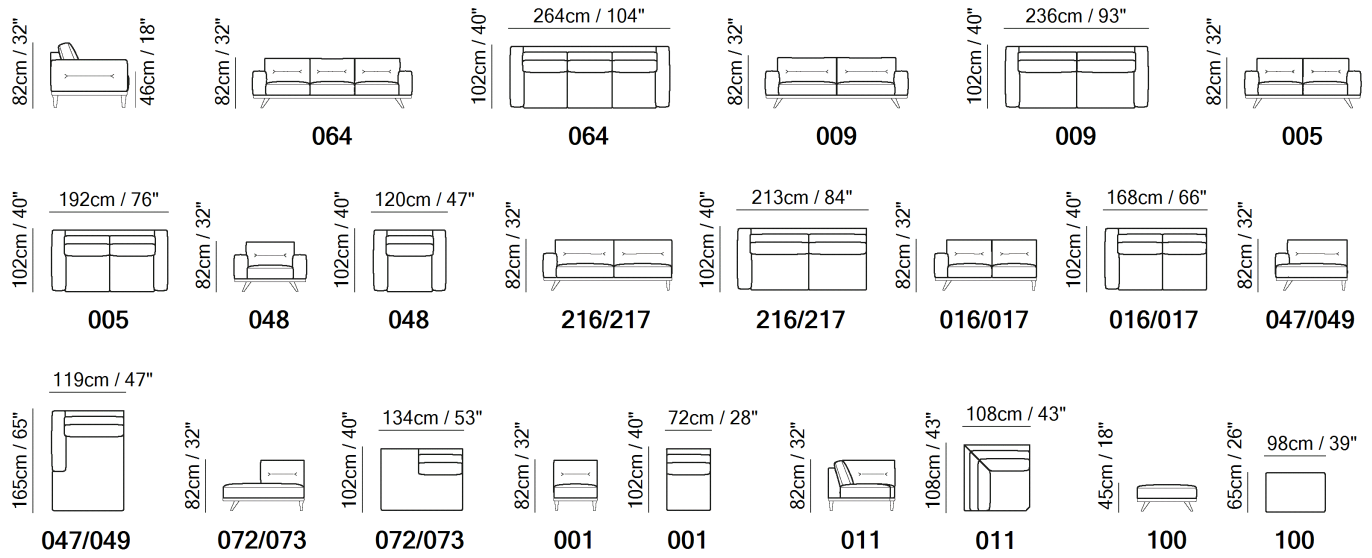

SCHEMATICS

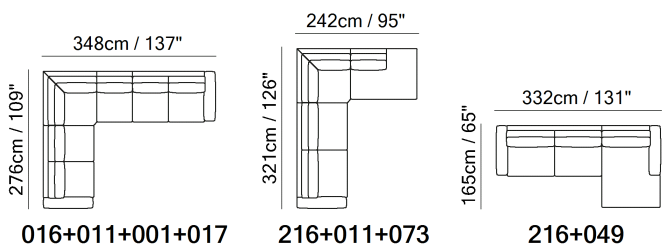

COMPOSITION EXAMPLES



TECHNICAL INFORMATION

	<b>COVERING</b>	Leather <input checked="" type="checkbox"/>	Soft Cover <input checked="" type="checkbox"/>				
	<b>FILLING</b>	Arms	<input type="checkbox"/> Fiber <input checked="" type="checkbox"/> Foam <input type="checkbox"/> Feather/Fiber Mix <input type="checkbox"/> Feather	Seat cushion	<input type="checkbox"/> Fiber <input checked="" type="checkbox"/> Foam <input type="checkbox"/> Feather/Fiber Mix <input type="checkbox"/> Feather	Back cushion	<input type="checkbox"/> Fiber <input checked="" type="checkbox"/> Foam <input type="checkbox"/> Feather/Fiber Mix <input type="checkbox"/> Feather
	<b>COMFORT</b>	Firm Comfort <input checked="" type="checkbox"/>	Standard Comfort <input checked="" type="checkbox"/>				
	<b>FUNCTION</b>	Bed <input type="checkbox"/>	Electric motion <input type="checkbox"/>	Motion <input type="checkbox"/>	Recliner <input type="checkbox"/>	Sliding <input type="checkbox"/>	
	<b>VISUAL APPEARANCE*</b>	Low <input checked="" type="checkbox"/>	Medium <input type="checkbox"/>	High <input type="checkbox"/>			
	<b>LEGS</b>	Metal <input type="checkbox"/>	Wood <input checked="" type="checkbox"/>	Castors <input type="checkbox"/>	Plastic <input type="checkbox"/>	Upholstered <input type="checkbox"/>	

VISUAL APPEARANCE

The product may reveal various wrinkles due to the combination of Elasticity of the covering, characteristics of the interior construction and the design of the product.



Products with Visual Appearance listed as High or Medium would require higher degree of care, where seats and back cushions may require fluffing and plumping more often than Products with Visual Appearance listed as Low.

NOTES

- Available in leather (TG only) or fabric.
- Tight Seat Cushion (the seat cushions of the models are fixed to the frame)
- Loose Back Cushion (the back cushions of the model are not fixed to the frame)
- No Leather/Fabric Side (the sectional pieces have the side covered with lining and not leather nor fabric)
- Internal wooden frame.
- Feet will be in a bag inside the package and requires assembling.
- Packaging: Cardboard wrap.
- Wooden base and legs available in finishing 09 (Walnut) / 18 (Wengè)
- Feet height 16,5 cm

## NOTES

---



■ Vers. 254



■ Vers. 027









■ Vers. 005

**SCHEMATICS**



**COMPOSITION EXAMPLES**

TECHNICAL INFORMATION

	<b>COVERING</b>	Leather <input checked="" type="checkbox"/>	Soft Cover <input checked="" type="checkbox"/>			
	<b>FILLING</b>	Arms <input type="checkbox"/> Fiber <input checked="" type="checkbox"/> Foam <input type="checkbox"/> Feather/Fiber Mix <input type="checkbox"/> Feather	Seat cushion <input type="checkbox"/> Fiber <input checked="" type="checkbox"/> Foam <input type="checkbox"/> Feather/Fiber Mix <input type="checkbox"/> Feather	Back cushion <input type="checkbox"/> Fiber <input checked="" type="checkbox"/> Foam <input type="checkbox"/> Feather/Fiber Mix <input type="checkbox"/> Feather		
	<b>COMFORT</b>	Standard Comfort <input checked="" type="checkbox"/>	Firm Comfort <input checked="" type="checkbox"/>			
	<b>FUNCTION</b>	Bed <input checked="" type="checkbox"/>	Electric motion <input type="checkbox"/>	Motion <input type="checkbox"/>	Recliner <input type="checkbox"/>	Sliding <input type="checkbox"/>
	<b>VISUAL APPEARANCE*</b>	Low <input checked="" type="checkbox"/>	Medium <input type="checkbox"/>	High <input type="checkbox"/>		
	<b>LEGS</b>	Wood <input checked="" type="checkbox"/>	Metal <input checked="" type="checkbox"/>	Upholstered <input type="checkbox"/>	Plastic <input type="checkbox"/>	Castors <input type="checkbox"/>

VISUAL APPEARANCE

The product may reveal various wrinkles due to the combination of Elasticity of the covering, characteristics of the interior construction and the design of the product.



Products with Visual Appearance listed as High or Medium would require higher degree of care, where seats and back cushions may require fluffing and plumping more often than Products with Visual Appearance listed as Low.

BED MECHANISM & MATTRESS

MECHANISM		MATTRESS		
VERSIONS	TYPE	VERSIONS	TYPE	DIMENSIONS
				W L H
264,527,529,548	Ready-Bed electro-welded - Double folding	264,527	GREENPLUS	140 195 11
266,530,550,666,668,669	Ready-Bed electro-welded - Double folding	529,548	Memory	140 195 11
		266,666,668,669	GREENPLUS	160 195 11
		530,550	Memory	160 195 11

**Ready-Bed electro-welded** The back cushion goes under the bed mechanism.  
**GREENPLUS** GREENPLUS mattress is a patented, innovative product. It is ecological, made up of microporous elastomers. It has a great adaptation capacity to the various body pressure which gives big support to the spine. It is antibacterial and no-allergic.  
**Memory** Non-allergic memory mattress available with zippered cover that can be easily taken off and washed.

NOTES

- Available in leather or fabric.
- This model is available with split leather exterior covering (Side, Rear and Front Panels)
- Tight Seat Cushion (the seat cushions of the models are fixed to the frame)
- Tight Back Cushion (the back cushions of the models are fixed to the frame)
- No Leather/Fabric Side (the sectional pieces have the side covered with lining and not leather nor fabric)
- Internal wooden frame.
- Feet will be in a bag inside the package and requires assembling.
- Packaging: plastic wrap for stationary versions and cardboard box for sofabed versions.
- Feet available in wood finishings 09 (Walnut) / 18 (Wengè)

## NOTES

---

- Second option versions have feet available in metal finishing 78 (Black Chrome)
- Feet height 12,0 cm



■ Vers. 064



■ Vers. 239



■ Vers. 100+001+011+019



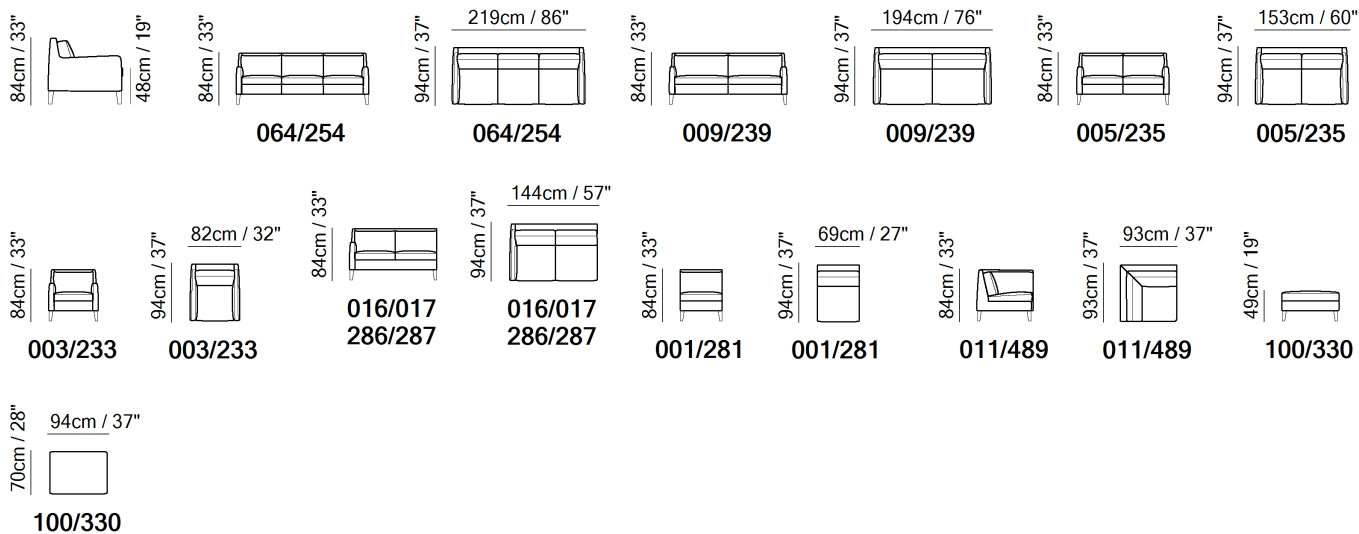

SCHEMATICS

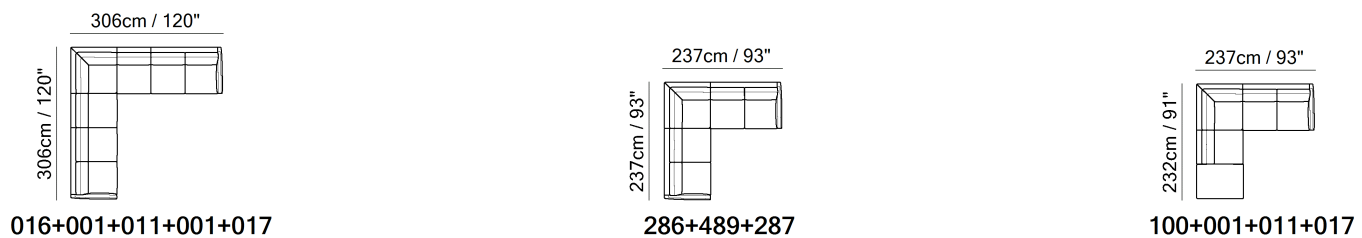

COMPOSITION EXAMPLES



TECHNICAL INFORMATION

	<b>COVERING</b>	Leather <input checked="" type="checkbox"/>	Soft Cover <input checked="" type="checkbox"/>				
	<b>FILLING</b>	Arms	<input type="checkbox"/> Fiber <input checked="" type="checkbox"/> Foam <input type="checkbox"/> Feather/Fiber Mix <input type="checkbox"/> Feather	Seat cushion	<input type="checkbox"/> Fiber <input checked="" type="checkbox"/> Foam <input type="checkbox"/> Feather/Fiber Mix <input type="checkbox"/> Feather	Back cushion	<input type="checkbox"/> Fiber <input checked="" type="checkbox"/> Foam <input type="checkbox"/> Feather/Fiber Mix <input type="checkbox"/> Feather
	<b>COMFORT</b>	Firm Comfort <input checked="" type="checkbox"/>	Standard Comfort <input checked="" type="checkbox"/>				
	<b>FUNCTION</b>	Bed <input type="checkbox"/>	Electric motion <input type="checkbox"/>	Motion <input type="checkbox"/>	Recliner <input type="checkbox"/>	Sliding <input type="checkbox"/>	
	<b>LEGS</b>	Metal <input checked="" type="checkbox"/>	Wood <input checked="" type="checkbox"/>	Castors <input type="checkbox"/>	Plastic <input type="checkbox"/>	Upholstered <input type="checkbox"/>	

NOTES

- All arms, back and seat surfaces are covered in Top Grain.
- This model is available with split leather exterior covering (Side, Rear and Front Panels)
- Versions 001 and 281 are finished on the sides to be used separately as armless chairs
- Tight Seat Cushion (the seat cushions of the models are fixed to the frame)
- Internal wooden frame.
- Feet will be in a bag inside the package and requires assembling.
- The model will be wrapped in a plastic bag.
- Feet available in wood finishings 09 (Walnut) / 18 (Wengè)
- Second option versions have feet available in metal finishing 75 (Glazed Nickel), lacquered metal 83 (moka) and brushed brass (70)
- Feet height 17,0 cm

**NOTES**

---



■ Vers. 530



■ Vers. 530





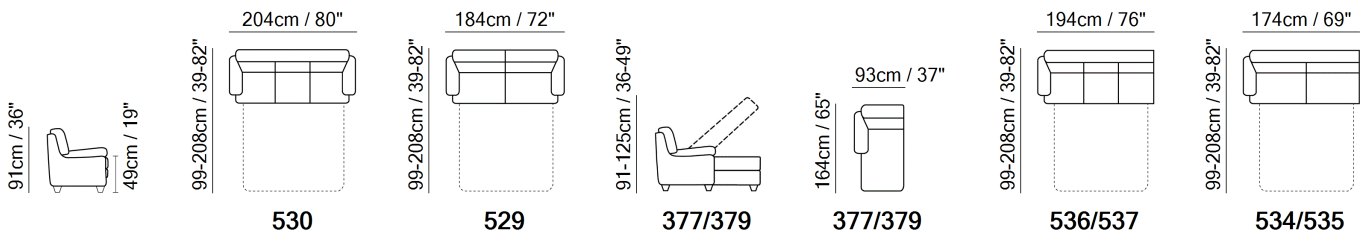

■ Vers. 377+535

**SCHEMATICS**



**COMPOSITION EXAMPLES**

TECHNICAL INFORMATION

	<b>COVERING</b>	Leather <input checked="" type="checkbox"/>	Soft Cover <input checked="" type="checkbox"/>				
	<b>FILLING</b>	Arms	<input type="checkbox"/> Fiber <input checked="" type="checkbox"/> Foam <input type="checkbox"/> Feather/Fiber Mix <input type="checkbox"/> Feather	Seat cushion	<input type="checkbox"/> Fiber <input checked="" type="checkbox"/> Foam <input type="checkbox"/> Feather/Fiber Mix <input type="checkbox"/> Feather	Back cushion	<input type="checkbox"/> Fiber <input checked="" type="checkbox"/> Foam <input type="checkbox"/> Feather/Fiber Mix <input type="checkbox"/> Feather
	<b>COMFORT</b>	Standard Comfort <input checked="" type="checkbox"/>	Firm Comfort <input type="checkbox"/>				
	<b>FUNCTION</b>	Bed <input type="checkbox"/>	Electric motion <input type="checkbox"/>	Motion <input type="checkbox"/>	Recliner <input type="checkbox"/>	Sliding <input type="checkbox"/>	
	<b>LEGS</b>	Wood <input checked="" type="checkbox"/>	Metal <input type="checkbox"/>	Upholstered <input type="checkbox"/>	Plastic <input type="checkbox"/>	Castors <input type="checkbox"/>	

BED MECHANISM & MATTRESS

MECHANISM		MATTRESS		
VERSIONS	TYPE	VERSIONS	TYPE	DIMENSIONS
529,534,535	Ready-Bed electro-welded - Double folding	529,534,535	Memory	W L H 140 195 17
530,536,537	Ready-Bed electro-welded - Double folding	530,536,537	Memory	160 195 17

**Ready-Bed electro-welded** The back cushion goes under the bed mechanism.  
**Memory** Non-allergic memory mattress available with zippered cover that can be easily taken off and washed.

NOTES

- All arms, back and seat surfaces are covered in Top Grain.
- This model is available with split leather exterior covering (Side, Rear and Front Panels)
- Tight Seat Cushion (the seat cushions of the models are fixed to the frame)
- Tight Back Cushion (the back cushions of the models are fixed to the frame)
- No Leather/Fabric Side (the sectional pieces have the side covered with lining and not leather nor fabric)
- Internal wooden frame.
- Feet will be in a bag inside the package and requires assembling.
- The model will be wrapped in a plastic bag.
- Feet available in wood finishings 09 (Walnut) / 18 (Wengè)
- Feet height 4,0 cm

NOTES

---



■ Vers. 003



■ Vers. 003



■ Vers. 233

SCHEMATICS

---



003

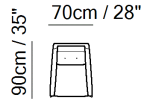

003

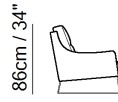

233





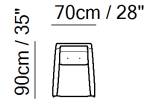

233



233

**TECHNICAL INFORMATION**

	<b>COVERING</b>	Leather <input checked="" type="checkbox"/>	Soft Cover <input checked="" type="checkbox"/>				
	<b>FILLING</b>	Arms	<input type="checkbox"/> Fiber <input checked="" type="checkbox"/> Foam <input type="checkbox"/> Feather/Fiber Mix <input type="checkbox"/> Feather	Seat cushion	<input type="checkbox"/> Fiber <input checked="" type="checkbox"/> Foam <input type="checkbox"/> Feather/Fiber Mix <input type="checkbox"/> Feather	Back cushion	<input type="checkbox"/> Fiber <input checked="" type="checkbox"/> Foam <input type="checkbox"/> Feather/Fiber Mix <input type="checkbox"/> Feather
	<b>COMFORT</b>	Firm Comfort <input type="checkbox"/>	Standard Comfort <input checked="" type="checkbox"/>				
	<b>FUNCTION</b>	Bed <input type="checkbox"/>	Electric motion <input type="checkbox"/>	Motion <input type="checkbox"/>	Recliner <input type="checkbox"/>	Sliding <input type="checkbox"/>	
	<b>LEGS</b>	Metal <input checked="" type="checkbox"/>	Wood <input checked="" type="checkbox"/>	Castors <input type="checkbox"/>	Plastic <input type="checkbox"/>	Upholstered <input type="checkbox"/>	

**NOTES**

- Available in leather or fabric.
- LEATHER: Model available only in Top Grain leather
- Model is available with contrast welt and button to be entered as second covering in the same category.
- FABRIC: In fabric contrast welt (as well as any another decorative detail such as a band under arm cushion or backrest or inserts) can be made with any color of art. Le Mans.
- Tight Seat Cushion (the seat cushions of the models are fixed to the frame)
- Tight Back Cushion (the back cushions of the models are fixed to the frame)
- Internal wooden frame.
- Feet will be in a bag inside the package and requires assembling.
- The model will be wrapped in a plastic bag.
- Front feet are slightly higher in respect to rear.
- Feet available in wood finishings 09 (Walnut) / 18 (Wengè)
- Second option versions have feet available in metal finishing 77 (Glossy Chromed)
- Feet height 22,0/16,0 cm

## NOTES

---



■ Vers. 064



■ Vers. 272+291+049



■ Vers. 272+076+N38+323+N52



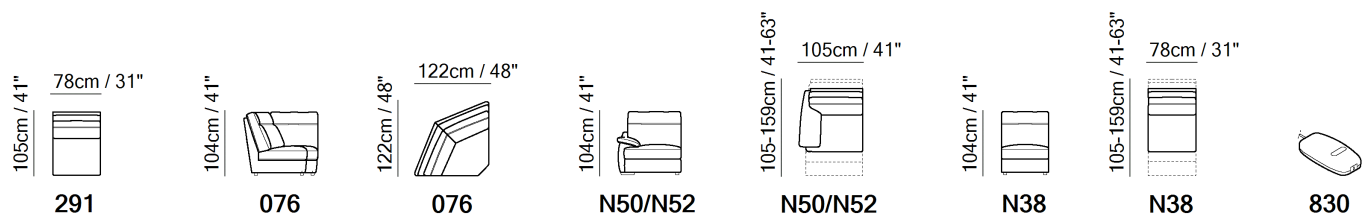
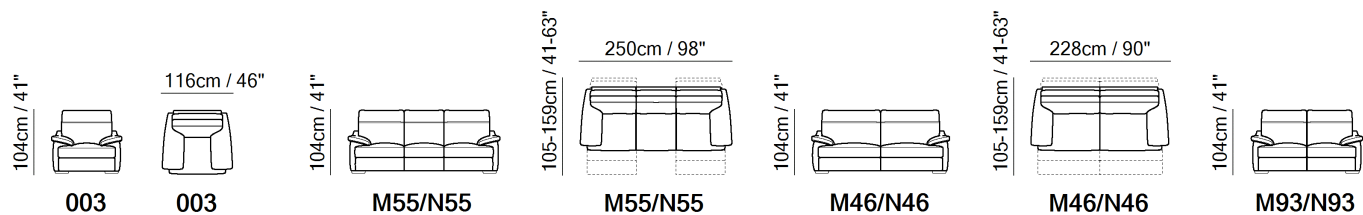
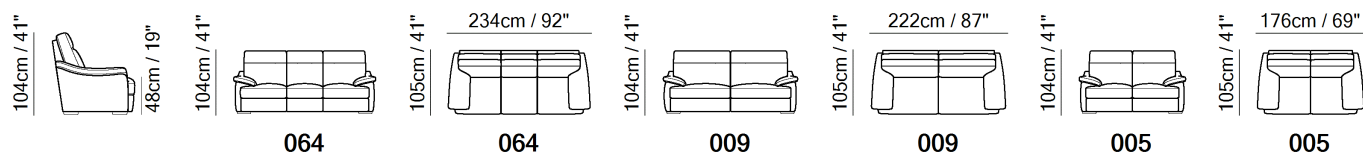

SCHEMATICS

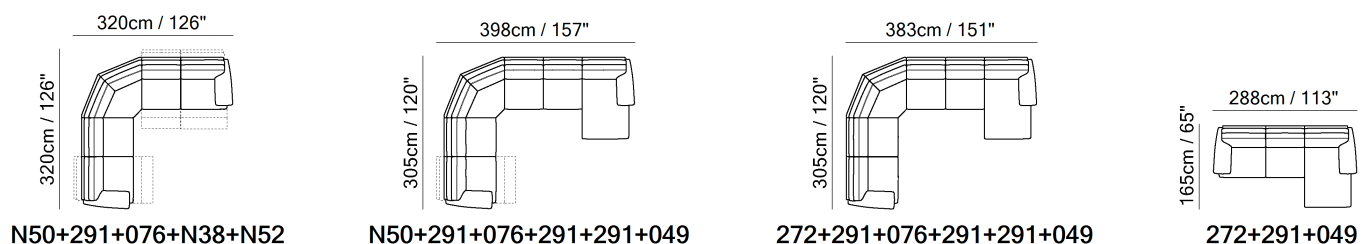

COMPOSITION EXAMPLES



TECHNICAL INFORMATION

	<b>COVERING</b>	Leather <input checked="" type="checkbox"/>					
	<b>FILLING</b>	Arms	<input type="checkbox"/> Fiber	Seat cushion	<input type="checkbox"/> Fiber	Back cushion	<input checked="" type="checkbox"/> Fiber
			<input checked="" type="checkbox"/> Foam		<input checked="" type="checkbox"/> Foam		<input type="checkbox"/> Foam
			<input type="checkbox"/> Feather/Fiber Mix		<input type="checkbox"/> Feather/Fiber Mix		<input type="checkbox"/> Feather/Fiber Mix
			<input type="checkbox"/> Feather		<input type="checkbox"/> Feather		<input type="checkbox"/> Feather
	<b>COMFORT</b>	Standard Comfort	Firm Comfort				
		<input checked="" type="checkbox"/>	<input checked="" type="checkbox"/>				
	<b>FUNCTION</b>	Bed	Electric motion	Motion	Recliner	Sliding	
		<input type="checkbox"/>	<input checked="" type="checkbox"/>	<input checked="" type="checkbox"/>	<input checked="" type="checkbox"/>	<input type="checkbox"/>	
	<b>LEGS</b>	Wood	Metal	Upholstered	Plastic	Castors	
		<input checked="" type="checkbox"/>	<input type="checkbox"/>	<input type="checkbox"/>	<input type="checkbox"/>	<input type="checkbox"/>	

NOTES

- Contrast stitching is available only with certain covers and option is managed directly in NARES.
- Model is available with contrast welt (or any another decorative detail such as a band under arm cushion) to be entered as second covering in the same category.
- When model is ordered in two-tone; stitching is the same color as second covering.
- Triple motion mechanism (vers. Nxx) activates footrest, headrest and lumbar support. The power mechanism switch is on the external side panel which also allocates a USB charging port.
- Models with triple motion mechanism have a "home" button that resets from the relax position to the original position all in one movement. The "home" button is the first of the three switches and is activated by continuous pressure.
- Versions V93 (2pc) - V55 (3pc) - V66 (2pc) are made and shipped in multiple packages.
- Versions M93 (2pc) - M55 (3pc) - M46 (2pc) are made and shipped in multiple packages.
- All arms, back and seat surfaces are covered in Top Grain.
- This model is available with split leather exterior covering (Side, Rear and Front Panels)
- Tight Seat Cushion (the seat cushions of the models are fixed to the frame)
- Tight Back Cushion (the back cushions of the models are fixed to the frame)
- No Leather/Fabric Side (the sectional pieces have the side covered with lining and not leather nor fabric)
- Internal wooden frame.
- Feet will be in a bag inside the package and requires assembling.
- The model will be wrapped in a plastic bag.
- Feet available in wood finishings 09 (Walnut) / 18 (Wengè)

## NOTES

---

- Feet height 4,0 cm



■ Vers. 233



■ Vers. 003





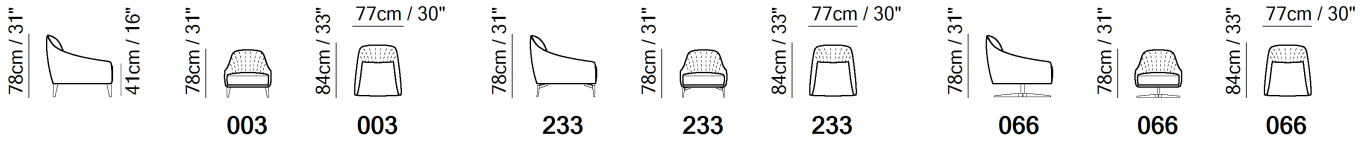

■ Vers. 066

SCHEMATICS



**TECHNICAL INFORMATION**

	<b>COVERING</b>	Leather <input checked="" type="checkbox"/>	Soft Cover <input checked="" type="checkbox"/>				
	<b>FILLING</b>	Arms	<input type="checkbox"/> Fiber <input checked="" type="checkbox"/> Foam <input type="checkbox"/> Feather/Fiber Mix <input type="checkbox"/> Feather	Seat cushion	<input type="checkbox"/> Fiber <input checked="" type="checkbox"/> Foam <input type="checkbox"/> Feather/Fiber Mix <input type="checkbox"/> Feather	Back cushion	<input type="checkbox"/> Fiber <input checked="" type="checkbox"/> Foam <input type="checkbox"/> Feather/Fiber Mix <input type="checkbox"/> Feather
	<b>COMFORT</b>	Firm Comfort <input type="checkbox"/>	Standard Comfort <input checked="" type="checkbox"/>				
	<b>FUNCTION</b>	Bed <input type="checkbox"/>	Electric motion <input type="checkbox"/>	Motion <input type="checkbox"/>	Recliner <input type="checkbox"/>	Sliding <input type="checkbox"/>	
	<b>LEGS</b>	Metal <input checked="" type="checkbox"/> Plastic <input type="checkbox"/>	Metal <input checked="" type="checkbox"/> Upholstered <input type="checkbox"/>	Metal <input checked="" type="checkbox"/>	Wood <input checked="" type="checkbox"/>	Castors <input type="checkbox"/>	

**NOTES**

- Available in leather (TG only) or fabric.
- Internal wooden frame.
- Feet will be in a bag inside the package and requires assembling.
- Packaging: Cardboard wrap.
- Feet available in wood finishings 09 (Walnut) / 18 (Wengè)
- Vers. 066: Metal base available in metal finishings 75 (Glazed Nickel) / 78 (Black Chrome)
- Second option versions have feet available in metal finishing 78 (Black Chrome) and 70 (brushed brass)
- Feet height 17,0 cm

NOTES

---



■ Vers. 009



■ Vers. 047+217



■ Vers. 018+011+073



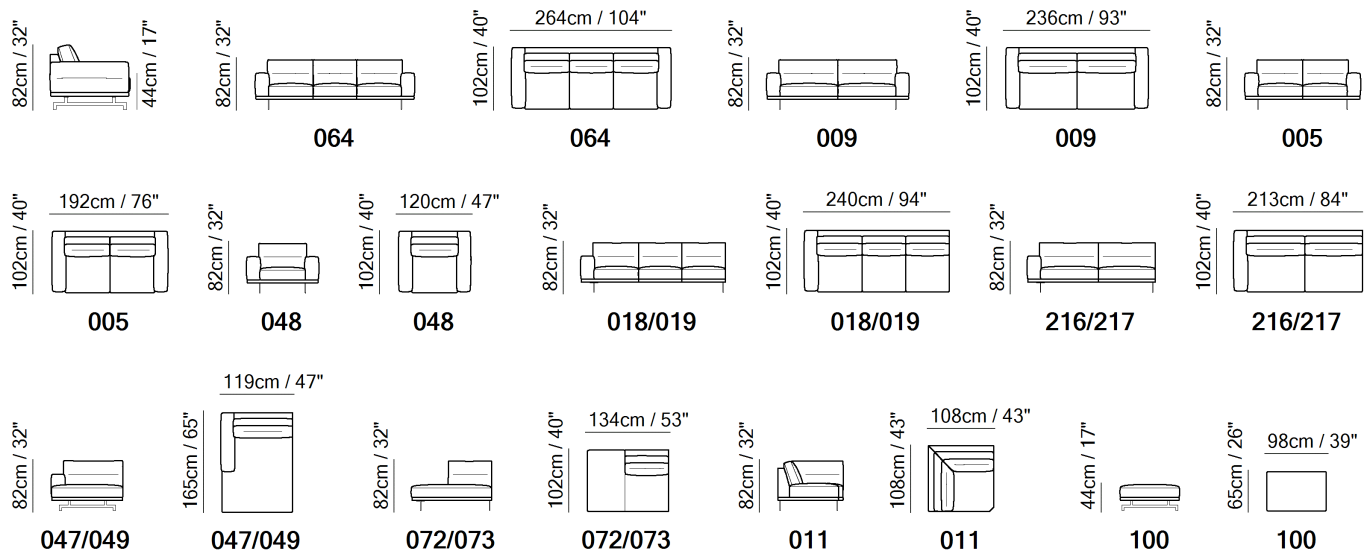

**SCHEMATICS**

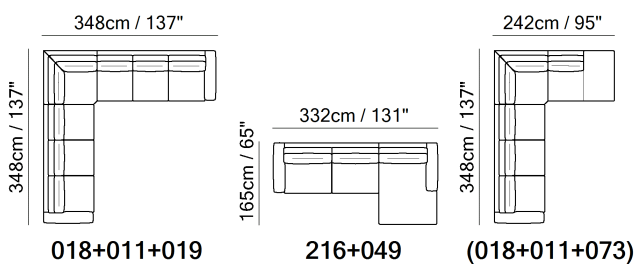

**COMPOSITION EXAMPLES**



**TECHNICAL INFORMATION**

	<b>COVERING</b>	Leather <input checked="" type="checkbox"/>	Soft Cover <input checked="" type="checkbox"/>			
	<b>FILLING</b>	Arms <input type="checkbox"/> Fiber <input checked="" type="checkbox"/> Foam <input type="checkbox"/> Feather/Fiber Mix <input type="checkbox"/> Feather	Seat cushion <input type="checkbox"/> Fiber <input checked="" type="checkbox"/> Foam <input type="checkbox"/> Feather/Fiber Mix <input type="checkbox"/> Feather	Back cushion <input type="checkbox"/> Fiber <input checked="" type="checkbox"/> Foam <input type="checkbox"/> Feather/Fiber Mix <input type="checkbox"/> Feather		
	<b>COMFORT</b>	Standard Comfort <input checked="" type="checkbox"/>	Firm Comfort <input checked="" type="checkbox"/>			
	<b>FUNCTION</b>	Bed <input type="checkbox"/>	Electric motion <input type="checkbox"/>	Motion <input type="checkbox"/>	Recliner <input type="checkbox"/>	Sliding <input type="checkbox"/>
	<b>LEGS</b>	Wood <input type="checkbox"/> Castors <input type="checkbox"/>	Metal <input checked="" type="checkbox"/>	Metal <input checked="" type="checkbox"/>	Upholstered <input type="checkbox"/>	Plastic <input type="checkbox"/>

**NOTES**

- Tight Seat Cushion (the seat cushions of the models are fixed to the frame)
- Loose Back Cushion (the back cushions of the model are not fixed to the frame)
- No Leather/Fabric Side (the sectional pieces have the side covered with lining and not leather nor fabric)
- Internal wooden frame.
- Feet will be in a bag inside the package and requires assembling.
- Packaging: Cardboard wrap.
- Feet available in metal finishings 75 (Glazed Nickel) / 78 (Black Chrome)
- Feet height 17,0 cm

NOTES

---



■ Vers. 450+452



■ Vers. 016+011+291+452



■ Vers. 003



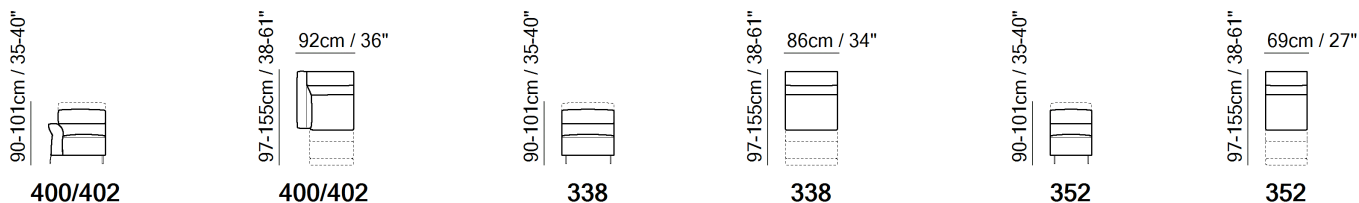
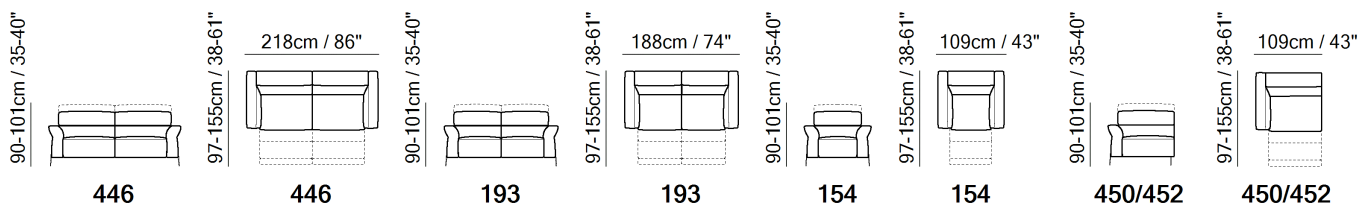
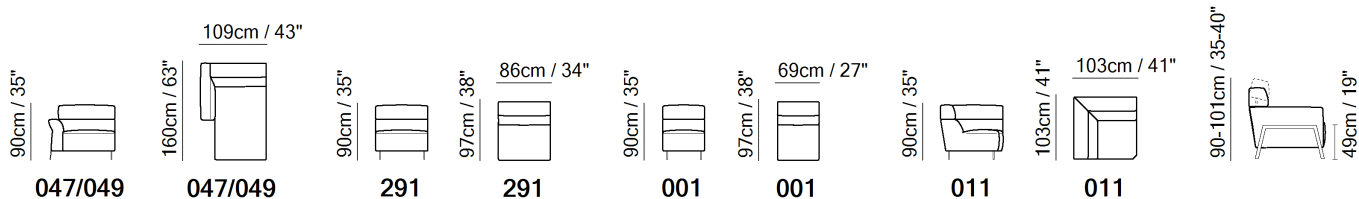
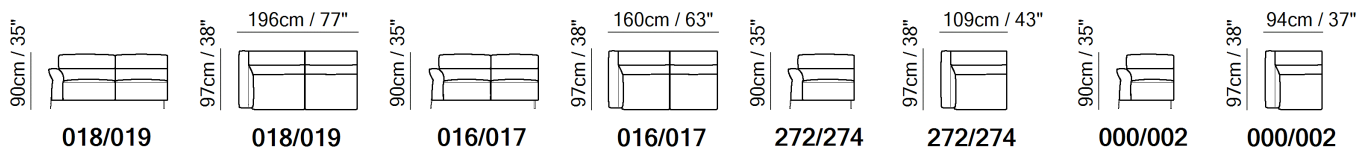
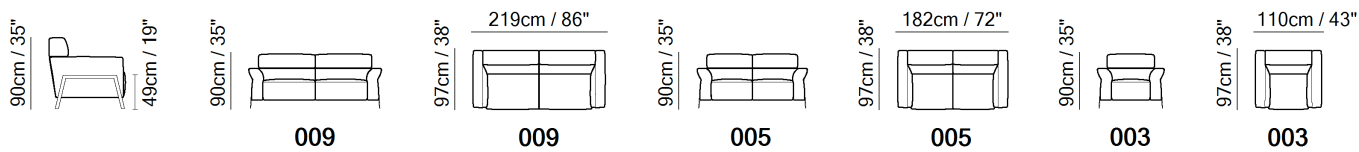

SCHEMATICS

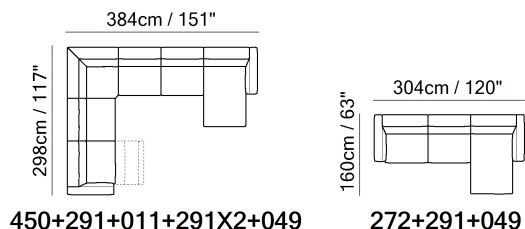
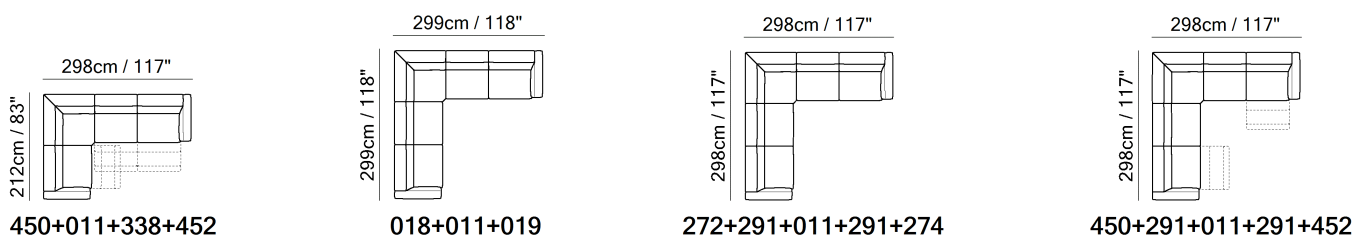

COMPOSITION EXAMPLES



## TECHNICAL INFORMATION

	<b>COVERING</b>	Leather <input checked="" type="checkbox"/>	Soft Cover <input checked="" type="checkbox"/>				
	<b>FILLING</b>	Arms	<input type="checkbox"/> Fiber <input checked="" type="checkbox"/> Foam <input type="checkbox"/> Feather/Fiber Mix <input type="checkbox"/> Feather	Seat cushion	<input type="checkbox"/> Fiber <input checked="" type="checkbox"/> Foam <input type="checkbox"/> Feather/Fiber Mix <input type="checkbox"/> Feather	Back cushion	<input type="checkbox"/> Fiber <input checked="" type="checkbox"/> Foam <input type="checkbox"/> Feather/Fiber Mix <input type="checkbox"/> Feather
	<b>COMFORT</b>	Firm Comfort <input type="checkbox"/>	Standard Comfort <input checked="" type="checkbox"/>				
	<b>FUNCTION</b>	Bed <input type="checkbox"/>	Electric motion <input checked="" type="checkbox"/>	Motion <input checked="" type="checkbox"/>	Recliner <input checked="" type="checkbox"/>	Sliding <input type="checkbox"/>	
	<b>LEGS</b>	Metal <input checked="" type="checkbox"/>	Wood <input type="checkbox"/>	Castors <input type="checkbox"/>	Plastic <input type="checkbox"/>	Upholstered <input type="checkbox"/>	

## NOTES

- LEATHER: Model available only in Top Grain leather
- Dual power mechanism with internal switch that activates recliner and headrest.
- The model has manual adjustable headrest.
- Tight Seat Cushion (the seat cushions of the models are fixed to the frame)
- Tight Back Cushion (the back cushions of the models are fixed to the frame)
- Internal wooden frame.
- Feet will be in a bag inside the package and requires assembling.
- The model will be wrapped in a plastic bag.
- Feet available in metal finishings 75 (Glazed Nickel) / 78 (Black Chrome)
- Feet height 14,0 cm

NOTES

---



■ Vers. 450+338+452



■ Vers. 047+291+452



■ Vers. 446



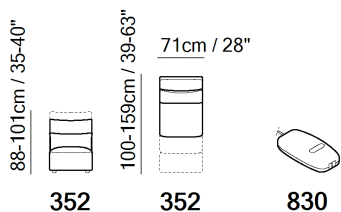
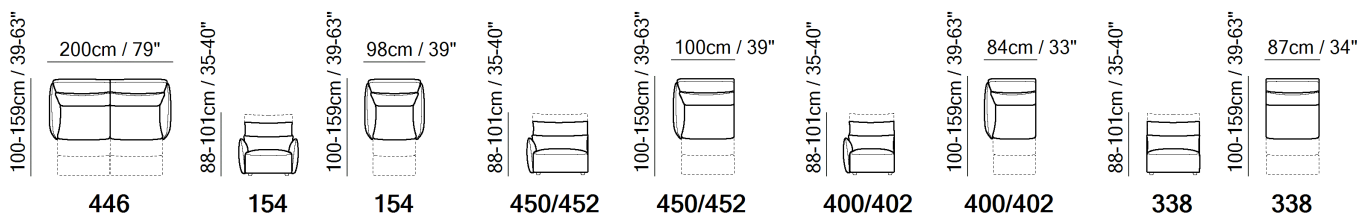
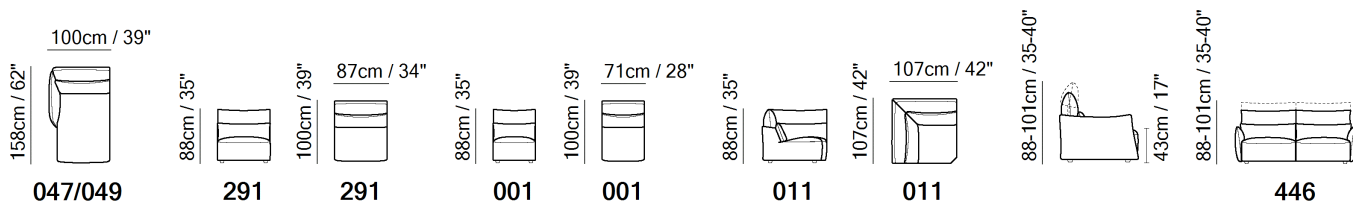
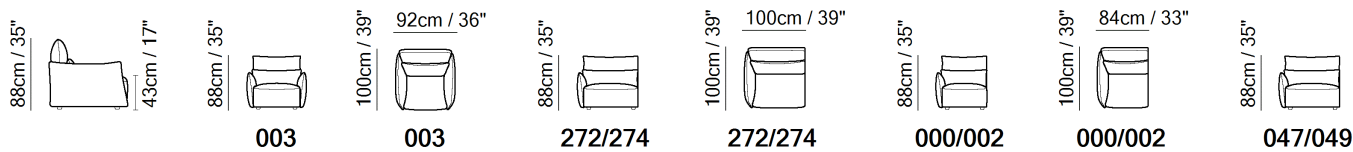

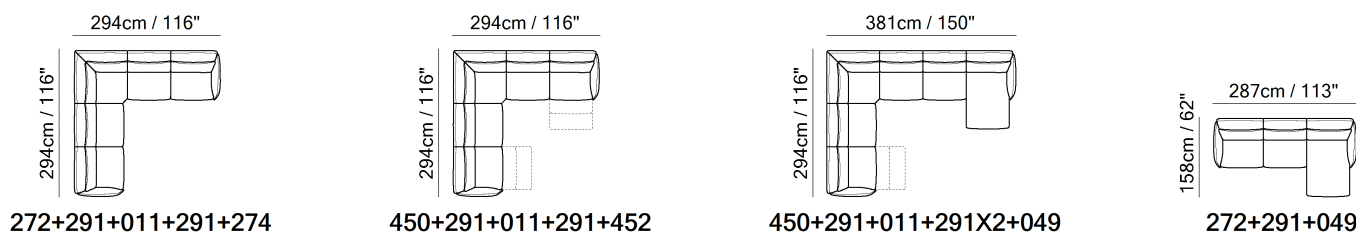

SCHEMATICS



COMPOSITION EXAMPLES



TECHNICAL INFORMATION

	<b>COVERING</b>	Leather <input checked="" type="checkbox"/>	Soft Cover <input checked="" type="checkbox"/>				
	<b>FILLING</b>	Arms	<input type="checkbox"/> Fiber <input checked="" type="checkbox"/> Foam <input type="checkbox"/> Feather/Fiber Mix <input type="checkbox"/> Feather	Seat cushion	<input type="checkbox"/> Fiber <input checked="" type="checkbox"/> Foam <input type="checkbox"/> Feather/Fiber Mix <input type="checkbox"/> Feather	Back cushion	<input type="checkbox"/> Fiber <input checked="" type="checkbox"/> Foam <input type="checkbox"/> Feather/Fiber Mix <input type="checkbox"/> Feather
	<b>COMFORT</b>	Standard Comfort <input checked="" type="checkbox"/>	Firm Comfort <input checked="" type="checkbox"/>				
	<b>FUNCTION</b>	Bed <input type="checkbox"/>	Electric motion <input checked="" type="checkbox"/>	Motion <input checked="" type="checkbox"/>	Recliner <input checked="" type="checkbox"/>	Sliding <input type="checkbox"/>	
	<b>VISUAL APPEARANCE*</b>	Low <input checked="" type="checkbox"/>	Medium <input type="checkbox"/>	High <input type="checkbox"/>			
	<b>LEGS</b>	Wood <input type="checkbox"/>	Metal <input type="checkbox"/>	Upholstered <input type="checkbox"/>	Plastic <input checked="" type="checkbox"/>	Castors <input type="checkbox"/>	

VISUAL APPEARANCE

The product may reveal various wrinkles due to the combination of Elasticity of the covering, characteristics of the interior construction and the design of the product.



Products with Visual Appearance listed as High or Medium would require higher degree of care, where seats and back cushions may require fluffing and plumping more often than Products with Visual Appearance listed as Low.

NOTES

- Available in leather (TG only) or fabric.
- Dual power mechanism with internal seat buttons (recliner and power headrest lift with manual adjustable tilt position)
- The model has manual adjustable headrest.
- A battery pack can be ordered with its own version code 830. For order entry please use XX for category and XXX for cover code. In order to optimize the duration of the battery, it is suggested to order one per each motion seat.
- Tight Seat Cushion (the seat cushions of the models are fixed to the frame)
- Tight Back Cushion (the back cushions of the models are fixed to the frame)
- Internal wooden frame.
- Feet will be in a bag inside the package and requires assembling.
- Packaging: Cardboard wrap.
- Feet height 4,0 cm

NOTES

---



■ Vers. 072+489+019



■ Vers. 072+489+019



■ Vers. 000+049



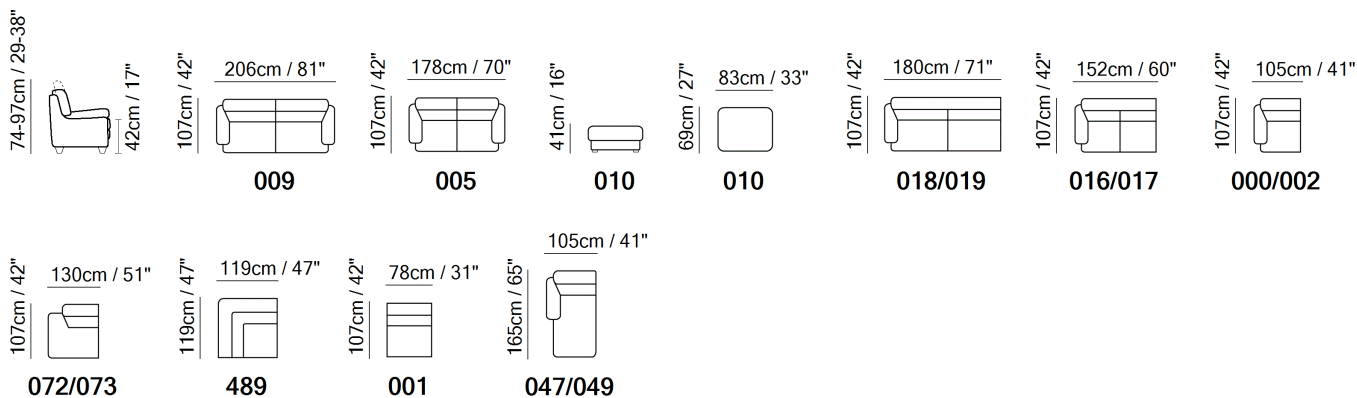

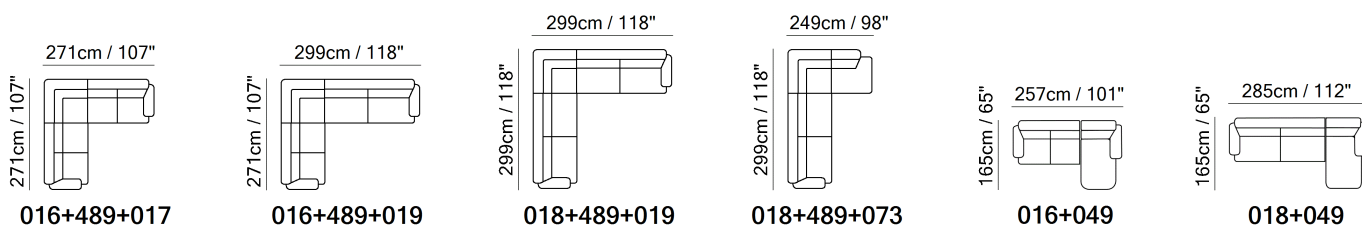

SCHEMATICS



COMPOSITION EXAMPLES



TECHNICAL INFORMATION

	<b>COVERING</b>	Leather <input checked="" type="checkbox"/>	Soft Cover <input checked="" type="checkbox"/>				
	<b>FILLING</b>	Arms	<input type="checkbox"/> Fiber <input checked="" type="checkbox"/> Foam <input type="checkbox"/> Feather/Fiber Mix <input type="checkbox"/> Feather	Seat cushion	<input type="checkbox"/> Fiber <input checked="" type="checkbox"/> Foam <input type="checkbox"/> Feather/Fiber Mix <input type="checkbox"/> Feather	Back cushion	<input type="checkbox"/> Fiber <input checked="" type="checkbox"/> Foam <input type="checkbox"/> Feather/Fiber Mix <input type="checkbox"/> Feather
	<b>COMFORT</b>	Firm Comfort <input checked="" type="checkbox"/>	Standard Comfort <input checked="" type="checkbox"/>				
	<b>FUNCTION</b>	Bed <input type="checkbox"/>	Electric motion <input type="checkbox"/>	Motion <input type="checkbox"/>	Recliner <input type="checkbox"/>	Sliding <input type="checkbox"/>	
	<b>VISUAL APPEARANCE*</b>	Low <input checked="" type="checkbox"/>	Medium <input type="checkbox"/>	High <input type="checkbox"/>			
	<b>LEGS</b>	Metal <input checked="" type="checkbox"/>	Wood <input type="checkbox"/>	Castors <input type="checkbox"/>	Plastic <input type="checkbox"/>	Upholstered <input type="checkbox"/>	

VISUAL APPEARANCE

The product may reveal various wrinkles due to the combination of Elasticity of the covering, characteristics of the interior construction and the design of the product.



Products with Visual Appearance listed as High or Medium would require higher degree of care, where seats and back cushions may require fluffing and plumping more often than Products with Visual Appearance listed as Low.

NOTES

- Available in leather or fabric.
- The model has manual adjustable arm and headrest.
- Tight Seat Cushion (the seat cushions of the models are fixed to the frame)
- Tight Back Cushion (the back cushions of the models are fixed to the frame)
- No Leather/Fabric Side (the sectional pieces have the side covered with lining and not leather nor fabric)
- Internal wooden frame.
- Feet will be in a bag inside the package and requires assembling.
- Packaging: plastic wrap for sectional versions and cardboard box for stationary versions.
- Feet available in metal finishings 77 (Glossy Chromed) / 78 (Black Chrome) / 79 (Matte Black)
- VERS 010: Feet available in metal finishings 77 (Glossy Chromed) / 79 (Matte Black)
- Feet height 12,0 cm; vers 010 ottoman 4,0 cm

NOTES

---



■ Vers. 066



■ Vers. 066





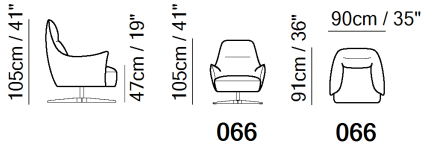

■ Vers. 066

SCHEMATICS

---



TECHNICAL INFORMATION

	<b>COVERING</b>	Leather <input checked="" type="checkbox"/>	Soft Cover <input checked="" type="checkbox"/>			
	<b>FILLING</b>	Arms <input type="checkbox"/> Fiber <input checked="" type="checkbox"/> Foam <input type="checkbox"/> Feather/Fiber Mix <input type="checkbox"/> Feather	Seat cushion <input type="checkbox"/> Fiber <input checked="" type="checkbox"/> Foam <input type="checkbox"/> Feather/Fiber Mix <input type="checkbox"/> Feather	Back cushion <input type="checkbox"/> Fiber <input checked="" type="checkbox"/> Foam <input type="checkbox"/> Feather/Fiber Mix <input type="checkbox"/> Feather		
	<b>COMFORT</b>	Standard Comfort <input checked="" type="checkbox"/>	Firm Comfort <input type="checkbox"/>			
	<b>FUNCTION</b>	Bed <input type="checkbox"/>	Electric motion <input type="checkbox"/>	Motion <input type="checkbox"/>	Recliner <input type="checkbox"/>	Sliding <input type="checkbox"/>
	<b>LEGS</b>	Wood <input type="checkbox"/> Castors <input type="checkbox"/>	Metal <input checked="" type="checkbox"/>	Metal <input checked="" type="checkbox"/>	Upholstered <input type="checkbox"/>	Plastic <input type="checkbox"/>

NOTES

- Available in leather (TG only) or fabric.
- Model is available with contrast welt (or any another decorative detail such as a band under arm cushion) to be entered as second covering in the same category.
- FABRIC: In fabric contrast welt (or any another decorative detail such as a band under arm cushion) can be made either in same category fabric or in leather with any color of Le Mans (only).
- Tight Seat Cushion (the seat cushions of the models are fixed to the frame)
- Tight Back Cushion (the back cushions of the models are fixed to the frame)
- Internal wooden frame.
- Feet will be in a bag inside the package and requires assembling.
- Packaging: Cardboard wrap.
- Metal base available in metal finishings 75 (Glazed Nickel) / 78 (Black Chrome)
- Feet height 20,0 cm

**NOTES**

---



■ Vers. N55



■ Vers. N55



■ Vers. 047+291+291+076+001+N02



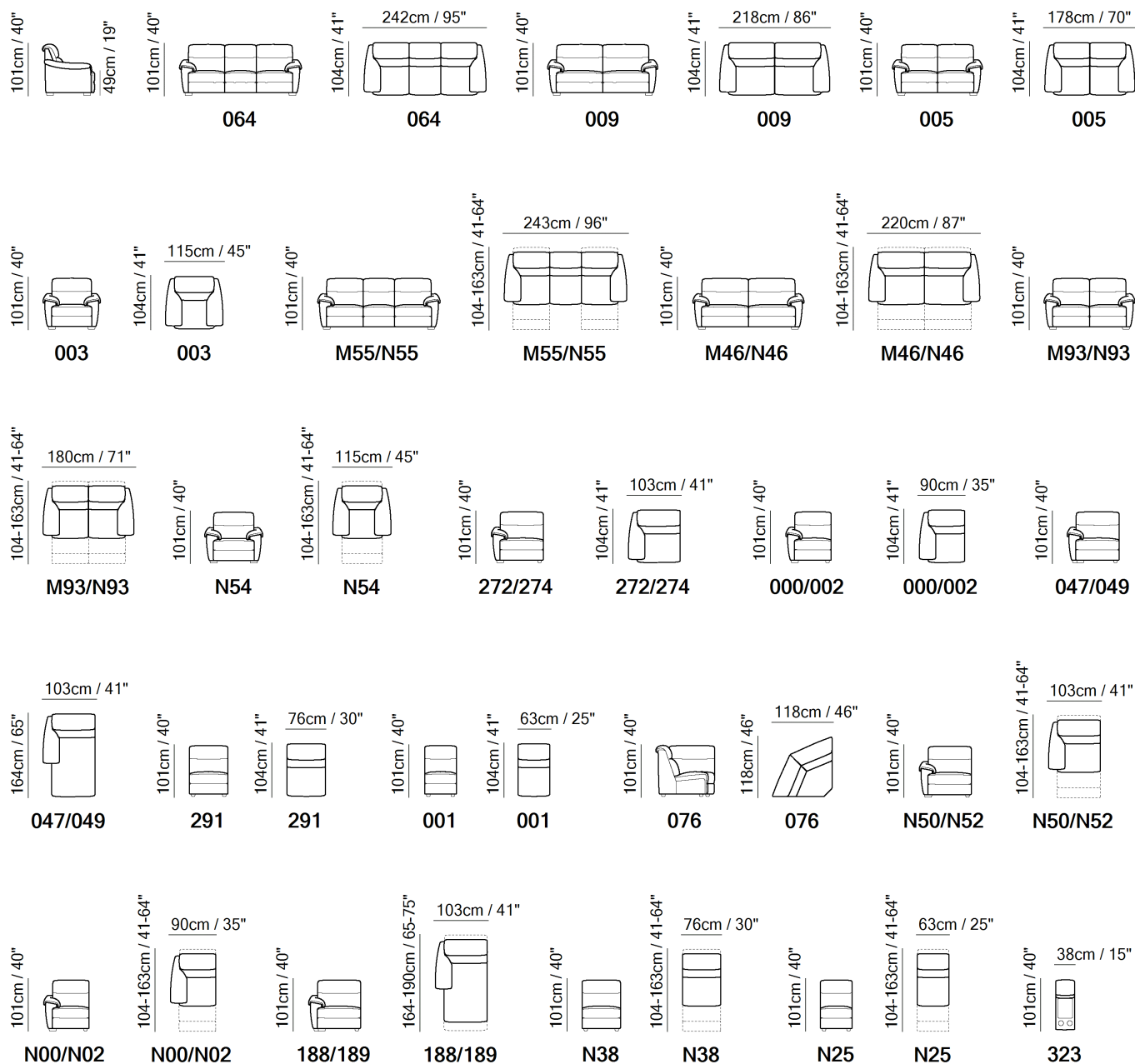

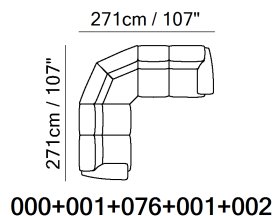
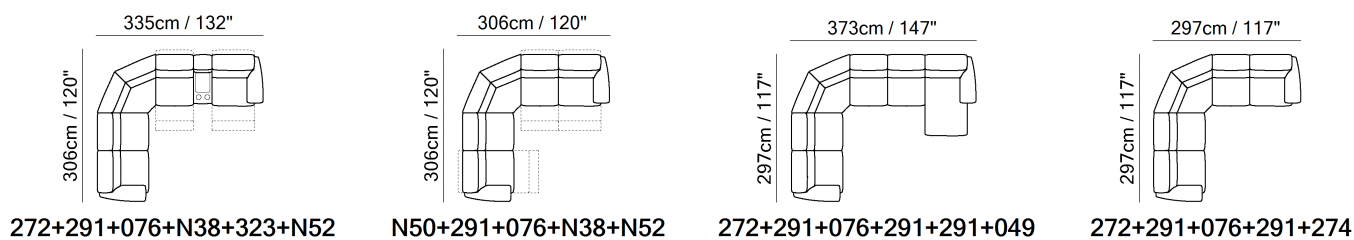

SCHEMATICS



COMPOSITION EXAMPLES



TECHNICAL INFORMATION

	<b>COVERING</b>	Leather <input checked="" type="checkbox"/>					
	<b>FILLING</b>	Arms	<input type="checkbox"/> Fiber	Seat cushion	<input type="checkbox"/> Fiber	Back cushion	<input type="checkbox"/> Fiber
			<input checked="" type="checkbox"/> Foam		<input checked="" type="checkbox"/> Foam		<input checked="" type="checkbox"/> Foam
			<input type="checkbox"/> Feather/Fiber Mix		<input type="checkbox"/> Feather/Fiber Mix		<input type="checkbox"/> Feather/Fiber Mix
			<input type="checkbox"/> Feather		<input type="checkbox"/> Feather		<input type="checkbox"/> Feather
	<b>COMFORT</b>	Firm Comfort <input checked="" type="checkbox"/>	Standard Comfort <input checked="" type="checkbox"/>				
	<b>FUNCTION</b>	Bed <input type="checkbox"/>	Electric motion <input checked="" type="checkbox"/>	Motion <input checked="" type="checkbox"/>	Recliner <input checked="" type="checkbox"/>	Sliding <input type="checkbox"/>	
	<b>VISUAL APPEARANCE*</b>	Low <input type="checkbox"/>	Medium <input checked="" type="checkbox"/>	High <input type="checkbox"/>			
	<b>LEGS</b>	Metal <input type="checkbox"/>	Wood <input checked="" type="checkbox"/>	Castors <input type="checkbox"/>	Plastic <input type="checkbox"/>	Upholstered <input type="checkbox"/>	

VISUAL APPEARANCE

The product may reveal various wrinkles due to the combination of Elasticity of the covering, characteristics of the interior construction and the design of the product.



Products with Visual Appearance listed as High or Medium would require higher degree of care, where seats and back cushions may require fluffing and plumping more often than Products with Visual Appearance listed as Low.

NOTES

- Model is available with contrast welt (or any another decorative detail such as a band under arm cushion) to be entered as second covering in the same category.
- Contrast stitching option is available only when the sofa is monocoloured meaning 1st and 2nd coverings are the same.
- The multifunctional console, with a full wooden finish, features a spacious tabletop, a storage drawer, a built-in USB port, and connectors for adding optional features—blending style, convenience, and versatility. The console can be ordered with its own version code 821 or 823. For order entry please use XXX for alias code and finishing code ST49 ash brown or ST50 ash blonde.
- CUBICOMFORT™ Triple-Motion Technology is a registered trademark. It denotes a set of independent motion systems that activate the various elements of the sofa (seat, backrest, headrest and footrest) allowing each person to adjust their position of absolute comfort to the millimeter.
- Triple motion mechanism (vers. Nxx) activates footrest, headrest and lumbar support. The power mechanism switch is on the external side panel which also allocates a USB charging port.
- Models with triple motion mechanism have a "home" button that resets from the relax position to the original position all in one movement. The "home" button is the first of the three switches and is activated by continuous pressure.

NOTES

---

- A battery pack can be ordered with its own version code 830. For order entry please use XX for category and XXX for cover code. In order to optimize the duration of the battery, it is suggested to order one per each motion seat.
- Versions M93 (2pc) - M55 (3pc) - M46 (2pc) are made and shipped in multiple packages.
- All arms, back and seat surfaces are covered in Top Grain.
- This model is available with split leather exterior covering (Side, Rear and Front Panels)
- Tight Seat Cushion (the seat cushions of the models are fixed to the frame)
- Tight Back Cushion (the back cushions of the models are fixed to the frame)
- With Leather Side (the sectional pieces come with leather sides)
- Internal wooden frame.
- Feet will be in a bag inside the package and requires assembling.
- Packaging: plastic wrap for stationary versions and cardboard box for motion/sofabed versions
- Feet available in wood finishings 09 (Walnut) / 18 (Wengè)
- Feet height 5,5 cm



■ Vers. 066



■ Vers. 066





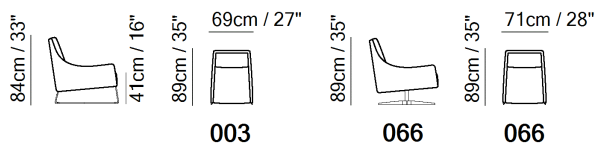

■ Vers. 003

SCHEMATICS

---



TECHNICAL INFORMATION

	<b>COVERING</b>	Leather <input checked="" type="checkbox"/>	Soft Cover <input checked="" type="checkbox"/>				
	<b>FILLING</b>	Arms	<input type="checkbox"/> Fiber <input checked="" type="checkbox"/> Foam <input type="checkbox"/> Feather/Fiber Mix <input type="checkbox"/> Feather	Seat cushion	<input type="checkbox"/> Fiber <input checked="" type="checkbox"/> Foam <input type="checkbox"/> Feather/Fiber Mix <input type="checkbox"/> Feather	Back cushion	<input type="checkbox"/> Fiber <input checked="" type="checkbox"/> Foam <input type="checkbox"/> Feather/Fiber Mix <input type="checkbox"/> Feather
	<b>COMFORT</b>	Standard Comfort <input checked="" type="checkbox"/>	Firm Comfort <input type="checkbox"/>				
	<b>FUNCTION</b>	Bed <input type="checkbox"/>	Electric motion <input type="checkbox"/>	Motion <input type="checkbox"/>	Recliner <input type="checkbox"/>	Sliding <input type="checkbox"/>	
	<b>LEGS</b>	Wood <input type="checkbox"/> Plastic <input type="checkbox"/>	Metal <input checked="" type="checkbox"/> Castors <input type="checkbox"/>	Metal <input checked="" type="checkbox"/>	Metal <input checked="" type="checkbox"/>	Upholstered <input type="checkbox"/>	

NOTES

- Available in leather (TG only) or fabric.
- Internal wooden frame.
- Packaging: Cardboard wrap.
- With Feet Assembled (the model will be loaded with feet already mounted on the sofa).
- Front feet are slightly higher in respect to rear.
- Feet available in metal finishings 77 (Glossy Chromed) / 79 (Matte Black)
- Metal base available in metal finishings 75 (Glazed Nickel) / 78 (Black Chrome)
- Feet height 23,0/17,0 cm

**NOTES**

---



■ Vers. N55



■ Vers. N46



■ Vers. N50+N38+076+001+002



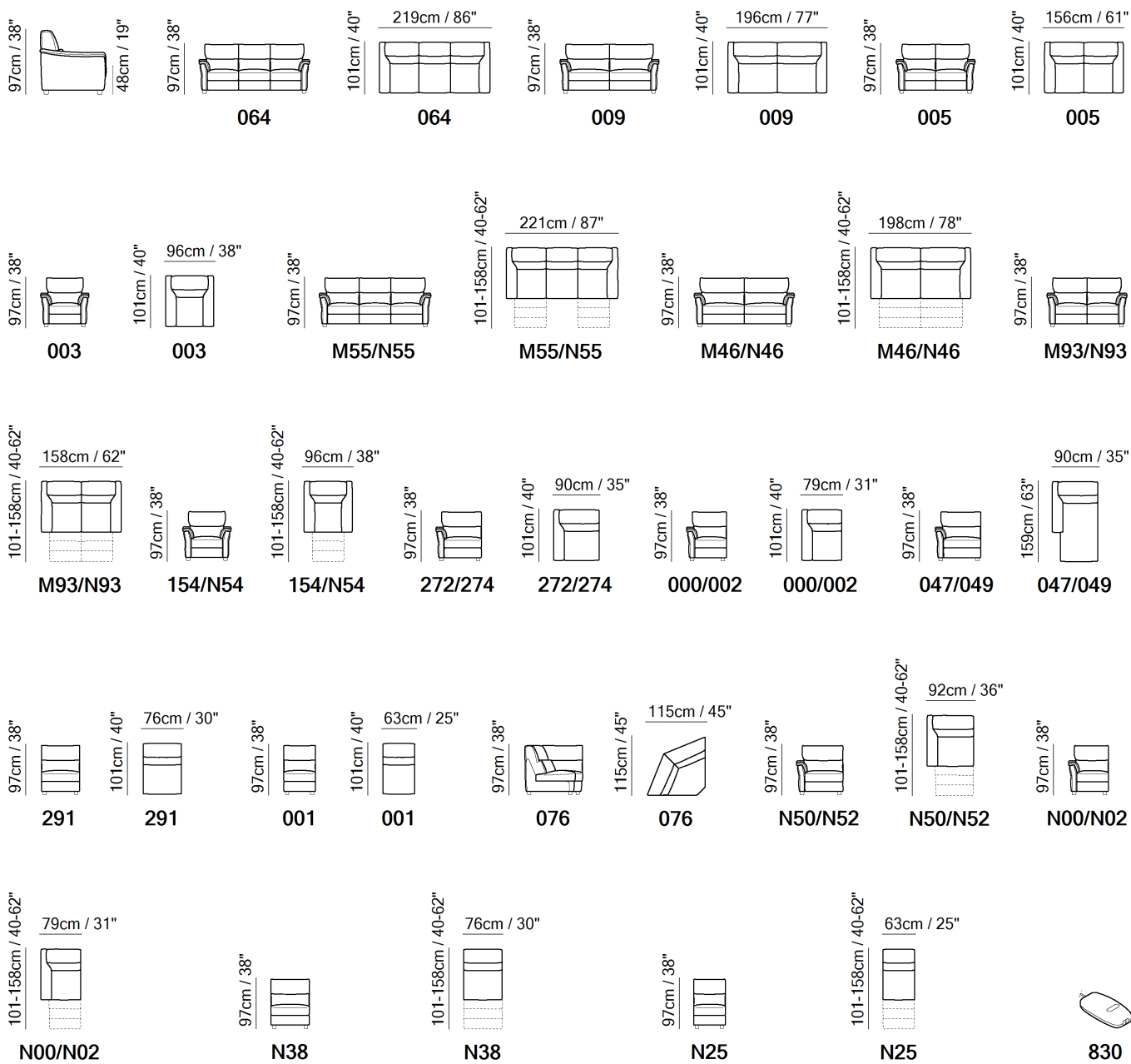

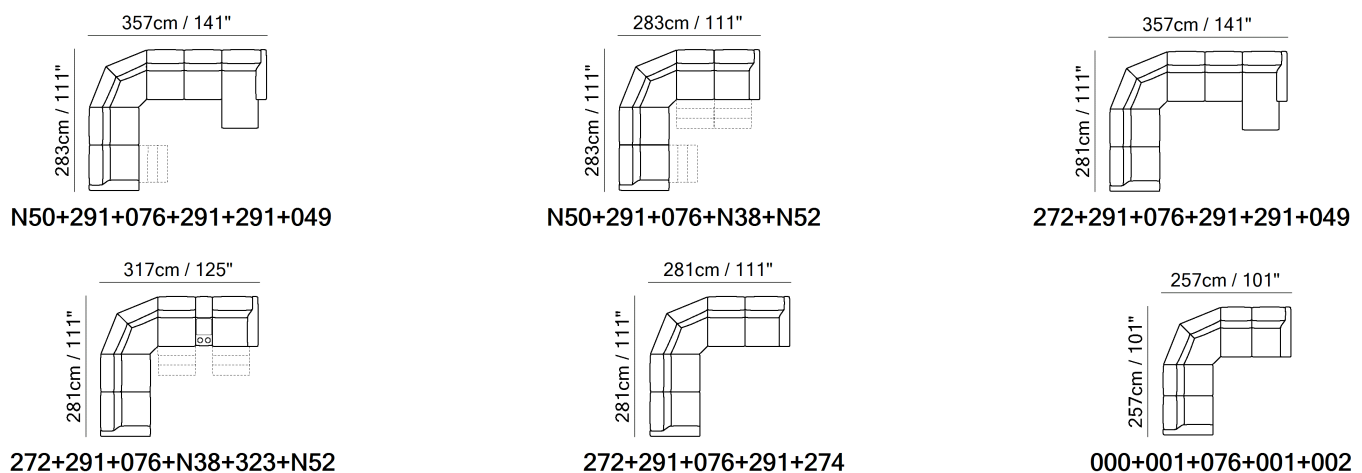

SCHEMATICS



COMPOSITION EXAMPLES



TECHNICAL INFORMATION

	<b>COVERING</b>	Leather <input checked="" type="checkbox"/>	Soft Cover <input checked="" type="checkbox"/>			
	<b>FILLING</b>	Arms <input type="checkbox"/> Fiber <input checked="" type="checkbox"/> Foam <input type="checkbox"/> Feather/Fiber Mix <input type="checkbox"/> Feather	Seat cushion <input type="checkbox"/> Fiber <input checked="" type="checkbox"/> Foam <input type="checkbox"/> Feather/Fiber Mix <input type="checkbox"/> Feather	Back cushion <input type="checkbox"/> Fiber <input checked="" type="checkbox"/> Foam <input type="checkbox"/> Feather/Fiber Mix <input type="checkbox"/> Feather		
	<b>COMFORT</b>	Firm Comfort <input checked="" type="checkbox"/>	Standard Comfort <input checked="" type="checkbox"/>			
	<b>FUNCTION</b>	Bed <input type="checkbox"/>	Electric motion <input checked="" type="checkbox"/>	Motion <input checked="" type="checkbox"/>	Recliner <input checked="" type="checkbox"/>	Sliding <input type="checkbox"/>
	<b>VISUAL APPEARANCE*</b>	Low <input checked="" type="checkbox"/>	Medium <input type="checkbox"/>	High <input type="checkbox"/>		
	<b>LEGS</b>	Metal <input type="checkbox"/>	Wood <input checked="" type="checkbox"/>	Castors <input type="checkbox"/>	Plastic <input type="checkbox"/>	Upholstered <input type="checkbox"/>

VISUAL APPEARANCE

The product may reveal various wrinkles due to the combination of Elasticity of the covering, characteristics of the interior construction and the design of the product.



Products with Visual Appearance listed as High or Medium would require higher degree of care, where seats and back cushions may require fluffing and plumping more often than Products with Visual Appearance listed as Low.

NOTES

- Available in leather or fabric.
- Contrast stitching is available only with certain covers and option is managed directly in NARES.
- CUBICOMFORT™ Triple-Motion Technology is a registered trademark. It denotes a set of independent motion systems that activate the various elements of the sofa (seat, backrest, headrest and footrest) allowing each person to adjust their position of absolute comfort to the millimeter.
- Triple motion mechanism (vers. Nxx) activates footrest, headrest and lumbar support. The power mechanism switch is on the external side panel which also allocates a USB charging port.
- Models with triple motion mechanism have a "home" button that resets from the relax position to the original position all in one movement. The "home" button is the first of the three switches and is activated by continuous pressure.
- A battery pack can be ordered with its own version code 830. For order entry please use XX for category and XXX for cover code. In order to optimize the duration of the battery, it is suggested to order one per each motion seat.
- Versions M93 (2pc) - M55 (3pc) - M46 (2pc) are made and shipped in multiple packages.
- All arms, back and seat surfaces are covered in Top Grain.
- This model is available with split leather exterior covering (Side, Rear and Front Panels)
- Tight Seat Cushion (the seat cushions of the models are fixed to the frame)

## NOTES

---

- Tight Back Cushion (the back cushions of the models are fixed to the frame)
- Internal wooden frame.
- Feet will be in a bag inside the package and requires assembling.
- Packaging: plastic wrap for stationary versions and cardboard box for motion/sofabed versions
- Feet available in wood finishings 09 (Walnut) / 18 (Wengè)
- Feet height 5,5 cm



■ Vers. 064



■ Vers. N46



■ Vers. 000+001+076+N38+N52



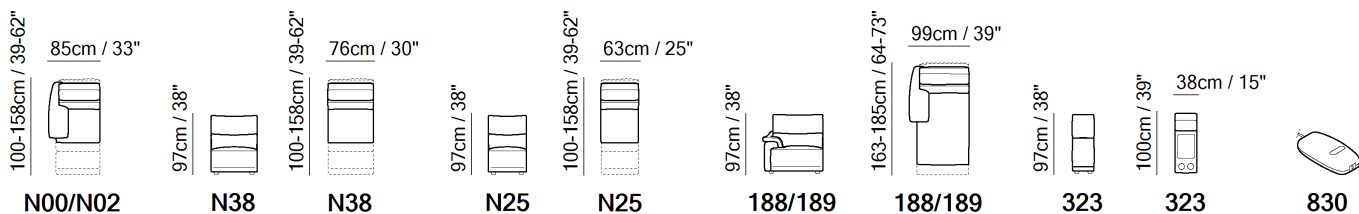
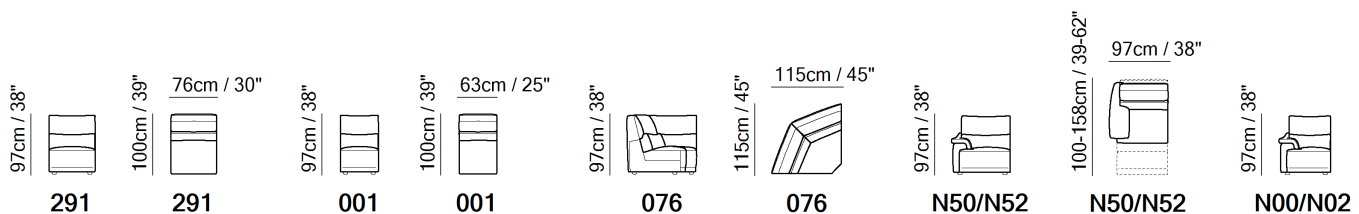
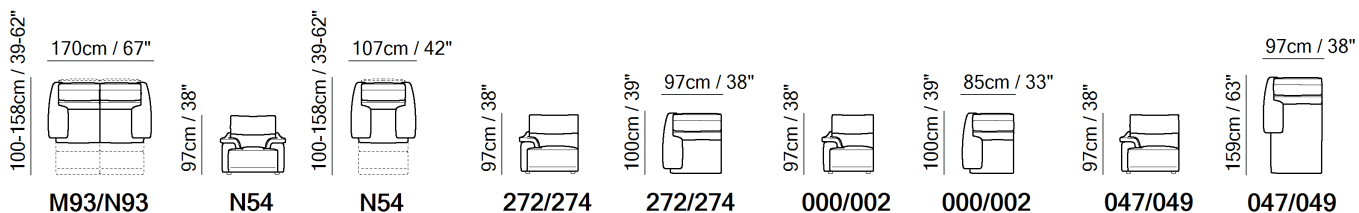
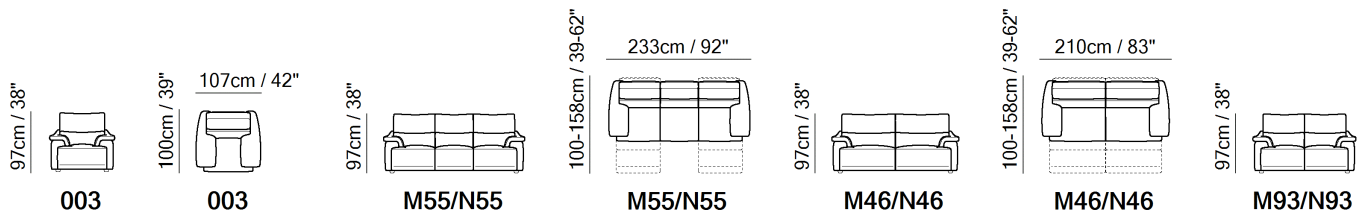
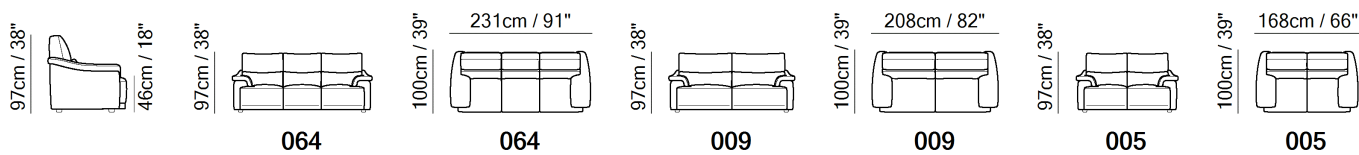

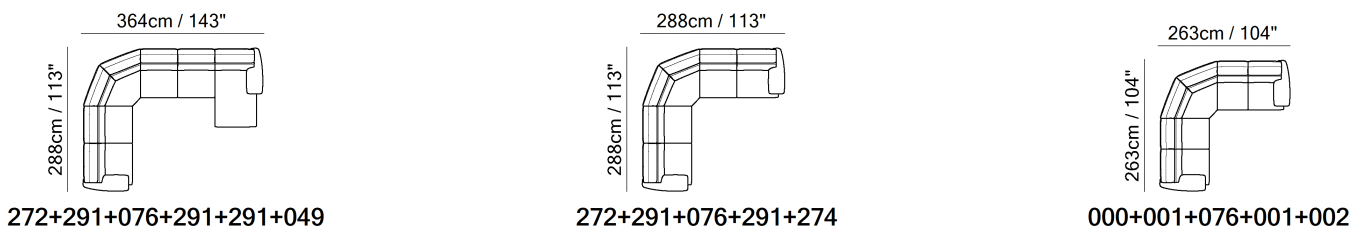
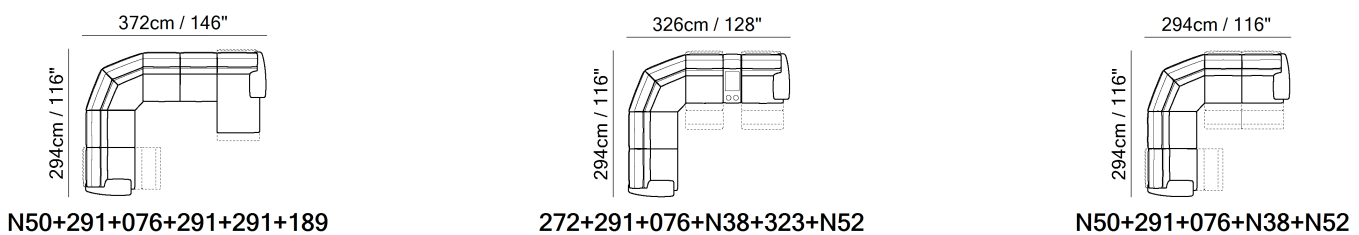

SCHEMATICS



COMPOSITION EXAMPLES



TECHNICAL INFORMATION

	<b>COVERING</b>	Leather <input checked="" type="checkbox"/>	Soft Cover <input checked="" type="checkbox"/>			
	<b>FILLING</b>	Arms <input type="checkbox"/> Fiber <input checked="" type="checkbox"/> Foam <input type="checkbox"/> Feather/Fiber Mix <input type="checkbox"/> Feather	Seat cushion <input type="checkbox"/> Fiber <input checked="" type="checkbox"/> Foam <input type="checkbox"/> Feather/Fiber Mix <input type="checkbox"/> Feather	Back cushion <input type="checkbox"/> Fiber <input checked="" type="checkbox"/> Foam <input type="checkbox"/> Feather/Fiber Mix <input type="checkbox"/> Feather		
	<b>COMFORT</b>	Standard Comfort <input checked="" type="checkbox"/>	Firm Comfort <input checked="" type="checkbox"/>			
	<b>FUNCTION</b>	Bed <input type="checkbox"/>	Electric motion <input checked="" type="checkbox"/>	Motion <input checked="" type="checkbox"/>	Recliner <input checked="" type="checkbox"/>	Sliding <input type="checkbox"/>
	<b>VISUAL APPEARANCE*</b>	Low <input checked="" type="checkbox"/>	Medium <input type="checkbox"/>	High <input type="checkbox"/>		
	<b>LEGS</b>	Wood <input type="checkbox"/>	Metal <input type="checkbox"/>	Upholstered <input type="checkbox"/>	Plastic <input checked="" type="checkbox"/>	Castors <input type="checkbox"/>

VISUAL APPEARANCE

The product may reveal various wrinkles due to the combination of Elasticity of the covering, characteristics of the interior construction and the design of the product.



Products with Visual Appearance listed as High or Medium would require higher degree of care, where seats and back cushions may require fluffing and plumping more often than Products with Visual Appearance listed as Low.

NOTES

- Available in leather or fabric.
- Contrast stitching is available only with certain covers and option is managed directly in NARES.
- CUBICOMFORT™ Triple-Motion Technology is a registered trademark. It denotes a set of independent motion systems that activate the various elements of the sofa (seat, backrest, headrest and footrest) allowing each person to adjust their position of absolute comfort to the millimeter.
- Triple motion mechanism (vers. Nxx) activates footrest, headrest and lumbar support. The power mechanism switch is on the external side panel which also allocates a USB charging port.
- Models with triple motion mechanism have a "home" button that resets from the relax position to the original position all in one movement. The "home" button is the first of the three switches and is activated by continuous pressure.
- A battery pack can be ordered with its own version code 830. For order entry please use XX for category and XXX for cover code. In order to optimize the duration of the battery, it is suggested to order one per each motion seat.
- Versions M93 (2pc) - M55 (3pc) - M46 (2pc) are made and shipped in multiple packages.
- All arms, back and seat surfaces are covered in Top Grain.
- This model is available with split leather exterior covering (Side, Rear and Front Panels)
- Tight Seat Cushion (the seat cushions of the models are fixed to the frame)

## NOTES

---

- Tight Back Cushion (the back cushions of the models are fixed to the frame)
- Internal wooden frame.
- Feet will be in a bag inside the package and requires assembling.
- Packaging: plastic wrap for stationary versions and cardboard box for motion/sofabled versions
- Feet height 4,0 cm



■ Vers. 009



■ Vers. 514+291+189



■ Vers. 514+323+638+399+291+049



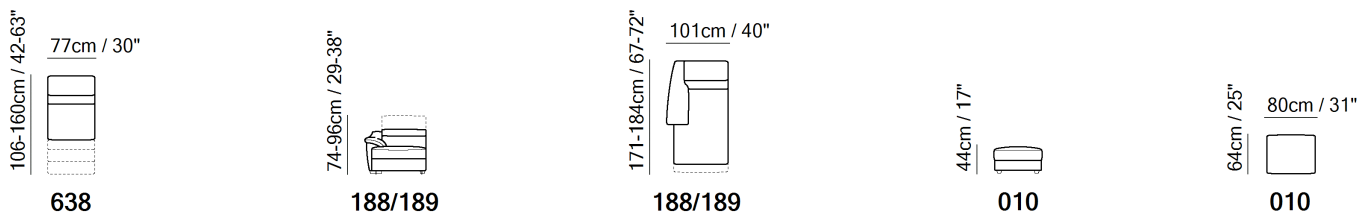
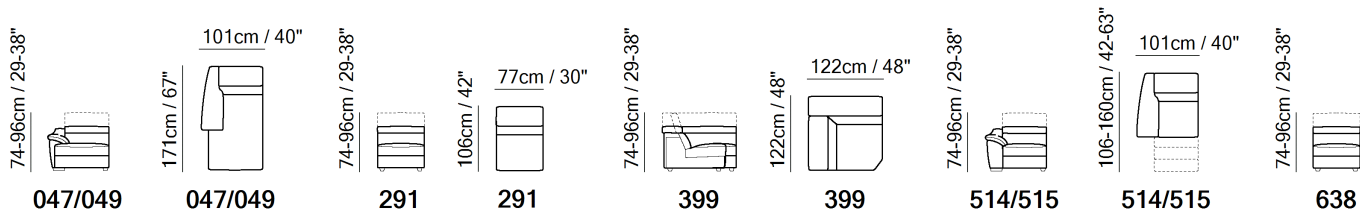
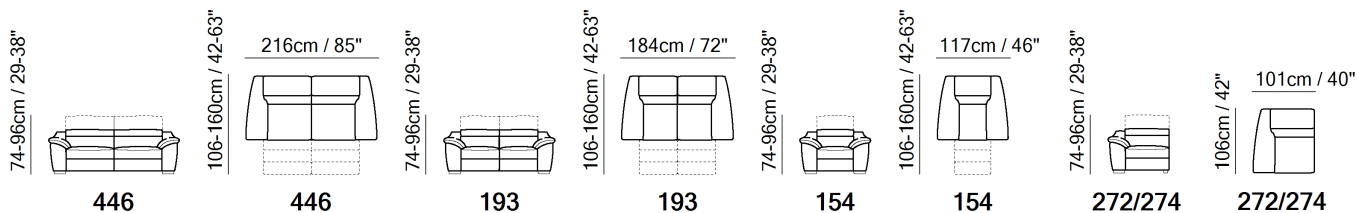
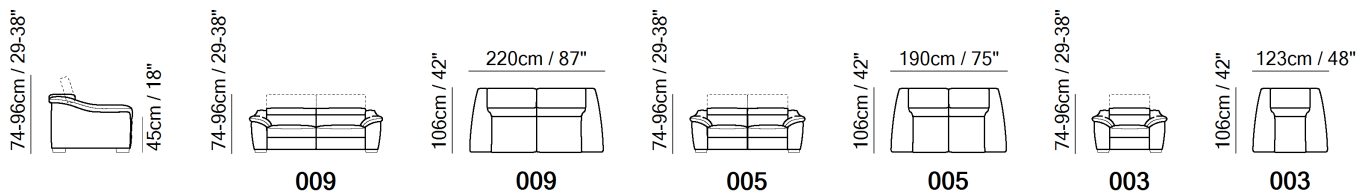

SCHEMATICS

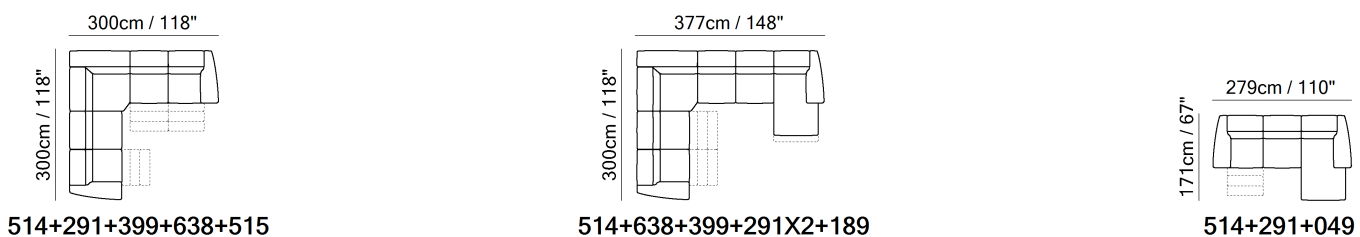

COMPOSITION EXAMPLES



TECHNICAL INFORMATION

	<b>COVERING</b>	Leather <input checked="" type="checkbox"/>					
	<b>FILLING</b>	Arms	<input type="checkbox"/> Fiber <input checked="" type="checkbox"/> Foam <input type="checkbox"/> Feather/Fiber Mix <input type="checkbox"/> Feather	Seat cushion	<input type="checkbox"/> Fiber <input checked="" type="checkbox"/> Foam <input type="checkbox"/> Feather/Fiber Mix <input type="checkbox"/> Feather	Back cushion	<input type="checkbox"/> Fiber <input checked="" type="checkbox"/> Foam <input type="checkbox"/> Feather/Fiber Mix <input type="checkbox"/> Feather
	<b>COMFORT</b>	Firm Comfort <input checked="" type="checkbox"/>	Standard Comfort <input checked="" type="checkbox"/>				
	<b>FUNCTION</b>	Bed <input type="checkbox"/>	Electric motion <input checked="" type="checkbox"/>	Motion <input checked="" type="checkbox"/>	Recliner <input checked="" type="checkbox"/>	Sliding <input type="checkbox"/>	
	<b>LEGS</b>	Metal <input type="checkbox"/>	Wood <input checked="" type="checkbox"/>	Castors <input type="checkbox"/>	Plastic <input type="checkbox"/>	Upholstered <input type="checkbox"/>	

NOTES

- Contrast stitching is available only with certain covers and option is managed directly in NARES.
- Model is characterized by decorative "mocassin" stitching.
- All arms, back and seat surfaces are covered in Top Grain.
- This model is available with split leather exterior covering (Side, Rear and Front Panels)
- Tight Seat Cushion (the seat cushions of the models are fixed to the frame)
- Tight Back Cushion (the back cushions of the models are fixed to the frame)
- No Leather/Fabric Side (the sectional pieces have the side covered with lining and not leather nor fabric)
- Feet will be in a bag inside the package and requires assembling.
- The model will be wrapped in a plastic bag.
- Feet available in wood finishings 09 (Walnut) / 18 (Wengè)
- Feet height 5,0 cm

NOTES

---



■ Vers. N46



■ Vers. N46



■ Vers. 072+489+001+N02



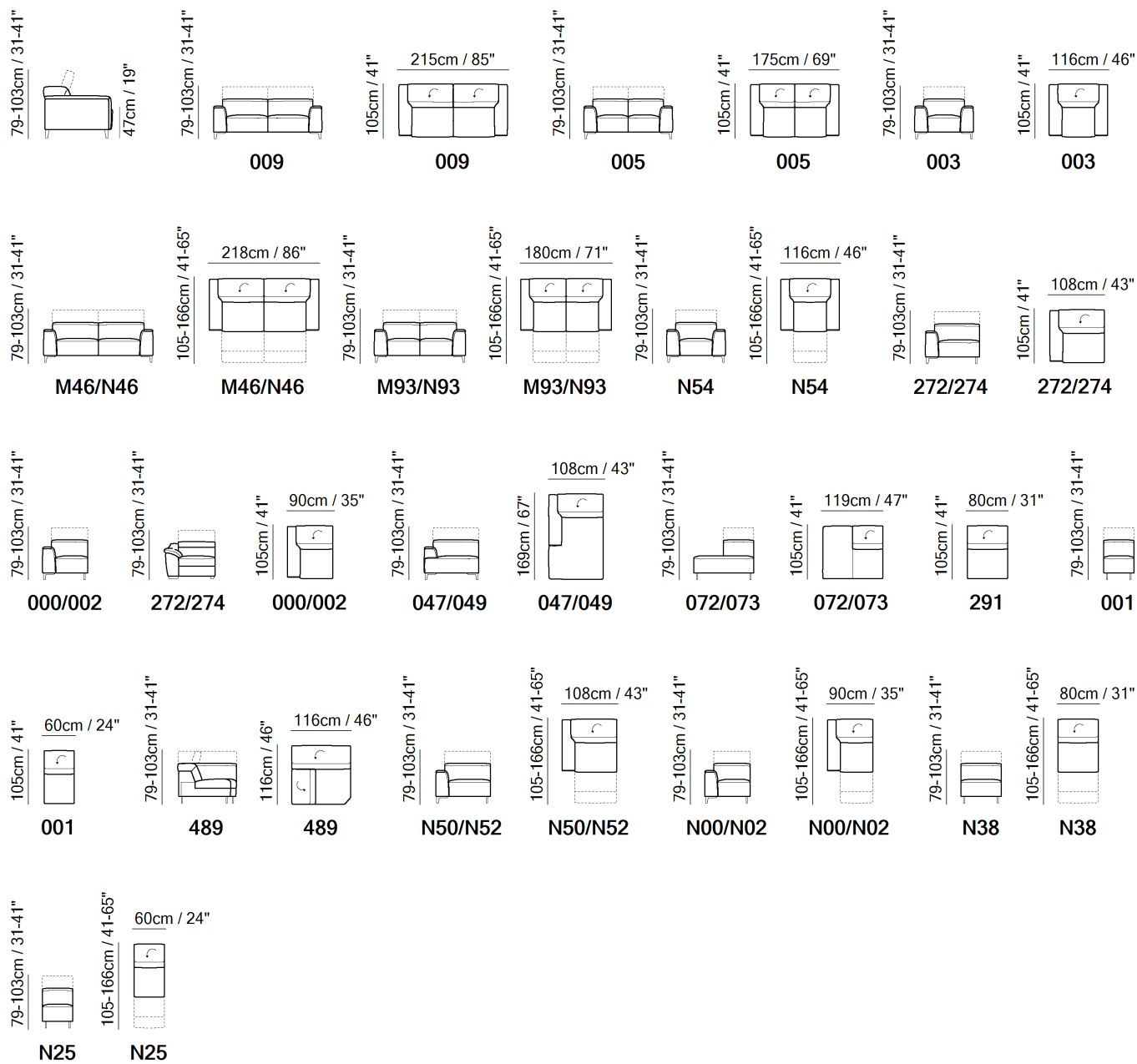

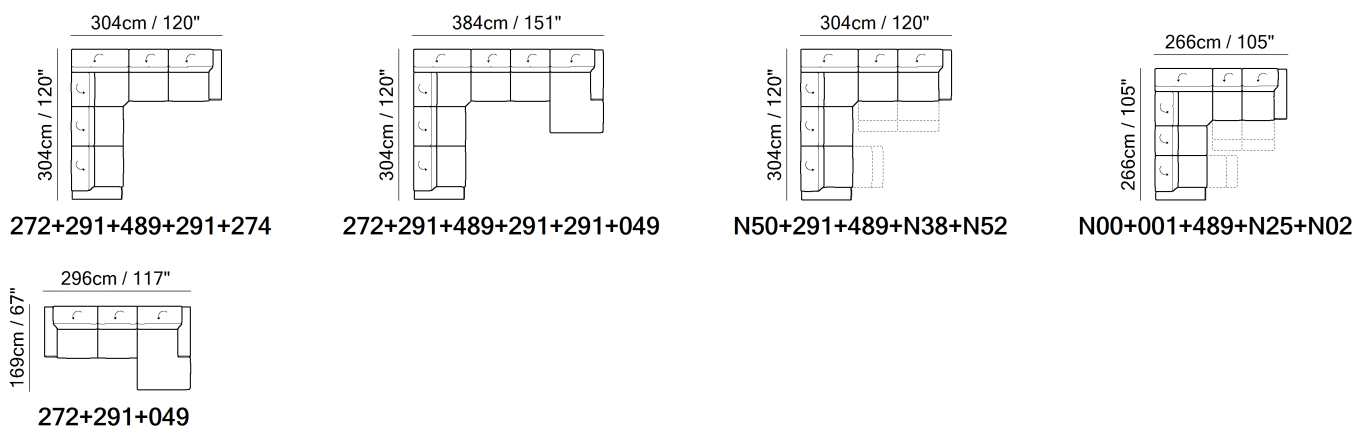

SCHEMATICS



COMPOSITION EXAMPLES



TECHNICAL INFORMATION

	<b>COVERING</b>	Leather <input checked="" type="checkbox"/>					
	<b>FILLING</b>	Arms	<input type="checkbox"/> Fiber <input checked="" type="checkbox"/> Foam <input type="checkbox"/> Feather/Fiber Mix <input type="checkbox"/> Feather	Seat cushion	<input type="checkbox"/> Fiber <input checked="" type="checkbox"/> Foam <input type="checkbox"/> Feather/Fiber Mix <input type="checkbox"/> Feather	Back cushion	<input type="checkbox"/> Fiber <input checked="" type="checkbox"/> Foam <input type="checkbox"/> Feather/Fiber Mix <input type="checkbox"/> Feather
	<b>COMFORT</b>	Standard Comfort <input checked="" type="checkbox"/>	Firm Comfort <input checked="" type="checkbox"/>				
	<b>FUNCTION</b>	Bed <input type="checkbox"/>	Electric motion <input checked="" type="checkbox"/>	Motion <input checked="" type="checkbox"/>	Recliner <input checked="" type="checkbox"/>	Sliding <input type="checkbox"/>	
	<b>VISUAL APPEARANCE*</b>	Low <input checked="" type="checkbox"/>	Medium <input type="checkbox"/>	High <input type="checkbox"/>			
	<b>LEGS</b>	Wood <input type="checkbox"/>	Metal <input checked="" type="checkbox"/>	Metal <input checked="" type="checkbox"/>	Upholstered <input type="checkbox"/>	Plastic <input type="checkbox"/>	
		Castors <input type="checkbox"/>					

VISUAL APPEARANCE

The product may reveal various wrinkles due to the combination of Elasticity of the covering, characteristics of the interior construction and the design of the product.



Products with Visual Appearance listed as High or Medium would require higher degree of care, where seats and back cushions may require fluffing and plumping more often than Products with Visual Appearance listed as Low.

NOTES

- LEATHER: Model available only in Top Grain leather
- Contrast stitching is available only with certain covers and option is managed directly in NARES.
- Model is characterized by decorative "mocassin" stitching.
- CUBICOMFORT™ Triple-Motion Technology is a registered trademark. It denotes a set of independent motion systems that activate the various elements of the sofa (seat, backrest, headrest and footrest) allowing each person to adjust their position of absolute comfort to the millimeter.
- The model has internal buttons between the arm and the seat cushion to activate the mechanism.
- Triple motion mechanism (vers. Nxx) activates footrest, headrest and lumbar support. The power mechanism switch is on the external side panel which also allocates a USB charging port.
- Models with triple motion mechanism have a "home" button that resets from the relax position to the original position all in one movement. The "home" button is the first of the three switches and is activated by continuous pressure.
- A battery pack can be ordered with its own version code 830. For order entry please use XX for category and XXX for cover code. In order to optimize the duration of the battery, it is suggested to order one per each motion seat.

## NOTES

---

- Versions M93 (2pc) - M55 (3pc) - M46 (2pc) are made and shipped in multiple packages.
- Tight Seat Cushion (the seat cushions of the models are fixed to the frame)
- Tight Back Cushion (the back cushions of the models are fixed to the frame)
- No Leather/Fabric Side (the sectional pieces have the side covered with lining and not leather nor fabric)
- Internal wooden frame.
- Feet will be in a bag inside the package and requires assembling.
- Packaging: Cardboard wrap.
- Feet available in metal finishings 77 (Glossy Chromed) / 78 (Black Chrome)
- Feet height 13,0 cm



■ Vers. 008



■ Vers. 008





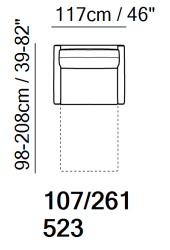
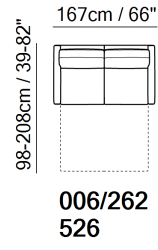
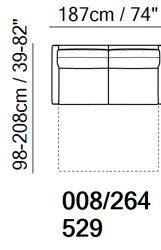
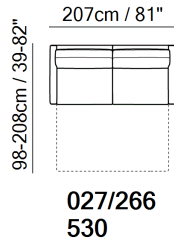
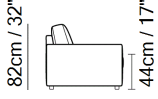

■ Vers. 008

**SCHEMATICS**



TECHNICAL INFORMATION

	<b>COVERING</b>	Leather <input checked="" type="checkbox"/>	Soft Cover <input checked="" type="checkbox"/>				
	<b>FILLING</b>	Arms	<input type="checkbox"/> Fiber <input checked="" type="checkbox"/> Foam <input type="checkbox"/> Feather/Fiber Mix <input type="checkbox"/> Feather	Seat cushion	<input type="checkbox"/> Fiber <input checked="" type="checkbox"/> Foam <input type="checkbox"/> Feather/Fiber Mix <input type="checkbox"/> Feather	Back cushion	<input type="checkbox"/> Fiber <input checked="" type="checkbox"/> Foam <input type="checkbox"/> Feather/Fiber Mix <input type="checkbox"/> Feather
	<b>COMFORT</b>	Firm Comfort <input type="checkbox"/>	Standard Comfort <input checked="" type="checkbox"/>				
	<b>FUNCTION</b>	Bed <input checked="" type="checkbox"/>	Electric motion <input type="checkbox"/>	Motion <input type="checkbox"/>	Recliner <input type="checkbox"/>	Sliding <input type="checkbox"/>	
	<b>LEGS</b>	Metal <input type="checkbox"/>	Wood <input type="checkbox"/>	Castors <input type="checkbox"/>	Plastic <input checked="" type="checkbox"/>	Upholstered <input type="checkbox"/>	

BED MECHANISM & MATTRESS

MECHANISM		MATTRESS		
VERSIONS	TYPE	VERSIONS	TYPE	DIMENSIONS
				W L H
107,261,523	Ready-Bed electro-welded - Double folding	523	Memory	70 185 11
006,262,526	Ready-Bed electro-welded - Double folding	107	Polyurethane foam	70 190 13
008,264,529	Ready-Bed electro-welded - Double folding	261	GREENPLUS	70 195 11
027,266,530	Ready-Bed electro-welded - Double folding	006	Polyurethane foam	120 190 13
		262	GREENPLUS	120 195 11
		526	Memory	120 195 11
		008	Polyurethane foam	140 190 13
		264	GREENPLUS	140 195 11
		529	Memory	140 195 11
		027	Polyurethane foam	160 190 13
		266	GREENPLUS	160 195 11
		530	Memory	160 195 11

<b>Ready-Bed electro-welded</b>	The back cushion goes under the bed mechanism.
<b>Memory</b>	Non-allergic memory mattress available with zippered cover that can be easily taken off and washed.
<b>GREENPLUS</b>	GREENPLUS mattress is a patented, innovative product. It is ecological, made up of microporous elastomers. It has a great adaptation capacity to the various body pressure which gives big support to the spine. It is antibacterial and no-allergic.

NOTES

- Available in leather or fabric.
- All arms, back and seat surfaces are covered in Top Grain.
- This model is available with split leather exterior covering (Side, Rear and Front Panels)
- Tight Seat Cushion (the seat cushions of the models are fixed to the frame)
- Tight Back Cushion (the back cushions of the models are fixed to the frame)
- Internal wooden frame.
- Feet will be in a bag inside the package and requires assembling.
- The model will be wrapped in a plastic bag.

**NOTES**

---



■ Vers. 009



■ Vers. 009





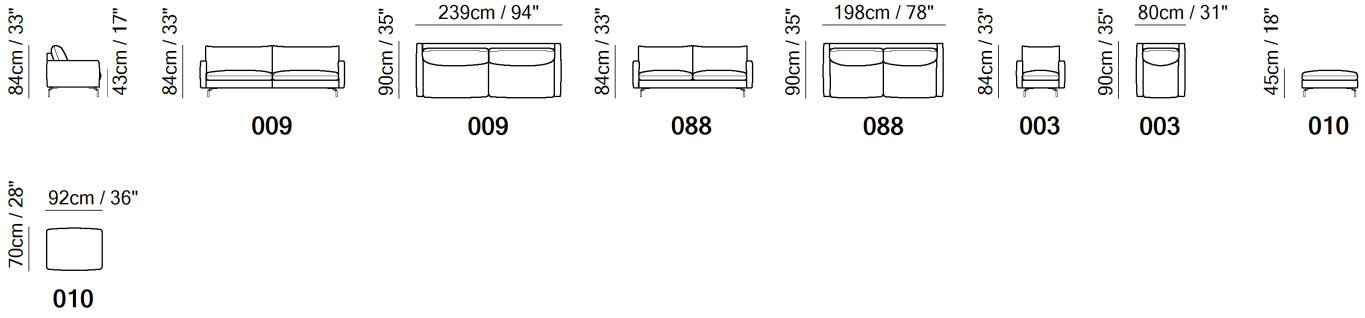

■ Vers. 009

SCHEMATICS



TECHNICAL INFORMATION

	<b>COVERING</b>	Leather <input checked="" type="checkbox"/>	Soft Cover <input checked="" type="checkbox"/>				
	<b>FILLING</b>	Arms	<input type="checkbox"/> Fiber <input checked="" type="checkbox"/> Foam <input type="checkbox"/> Feather/Fiber Mix <input type="checkbox"/> Feather	Seat cushion	<input type="checkbox"/> Fiber <input checked="" type="checkbox"/> Foam <input type="checkbox"/> Feather/Fiber Mix <input type="checkbox"/> Feather	Back cushion	<input type="checkbox"/> Fiber <input checked="" type="checkbox"/> Foam <input type="checkbox"/> Feather/Fiber Mix <input type="checkbox"/> Feather
	<b>COMFORT</b>	Standard Comfort <input checked="" type="checkbox"/>	Firm Comfort <input type="checkbox"/>				
	<b>FUNCTION</b>	Bed <input type="checkbox"/>	Electric motion <input type="checkbox"/>	Motion <input type="checkbox"/>	Recliner <input type="checkbox"/>	Sliding <input type="checkbox"/>	
	<b>LEGS</b>	Wood <input type="checkbox"/>	Metal <input checked="" type="checkbox"/>	Upholstered <input type="checkbox"/>	Plastic <input type="checkbox"/>	Castors <input type="checkbox"/>	

NOTES

- Available in leather (TG only) or fabric.
- Contrast stitching is available only with certain covers and option is managed directly in NARES.
- Tight Seat Cushion (the seat cushions of the models are fixed to the frame)
- Loose Back Cushion (the back cushions of the model are not fixed to the frame)
- Internal wooden frame.
- Feet will be in a bag inside the package and requires assembling.
- The model will be wrapped in a plastic bag.
- Feet available in metal finishings 77 (Glossy Chromed) / 79 (Matte Black)
- Feet height 15,5 cm

NOTES

---



■ Vers. 064



■ Vers. 047+217



■ Vers. 084+217



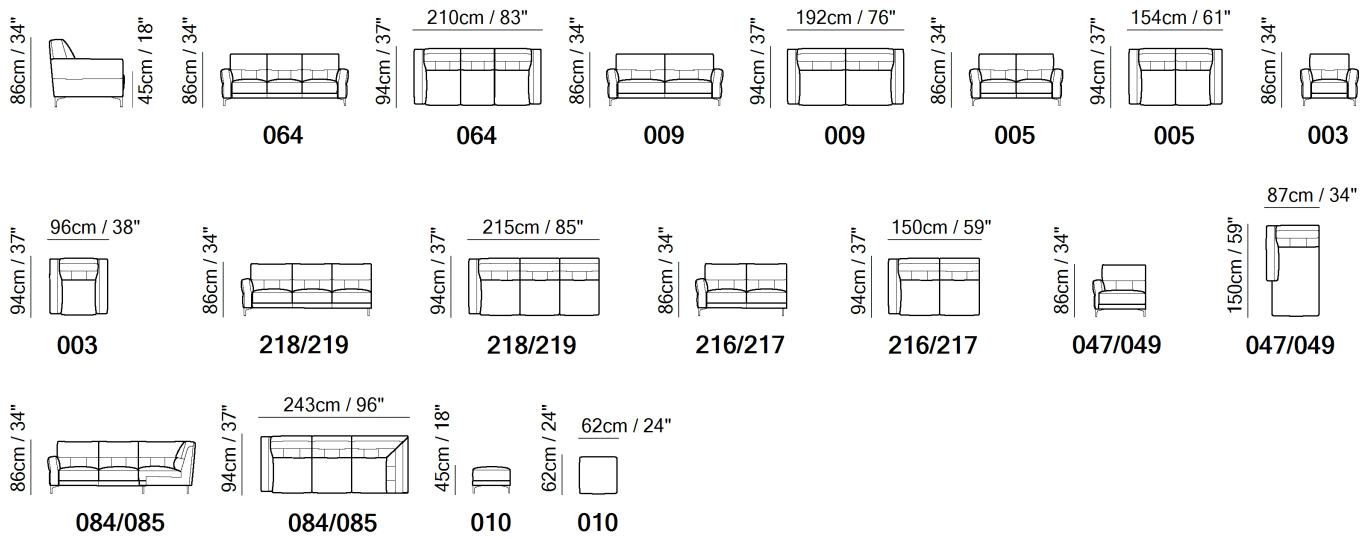

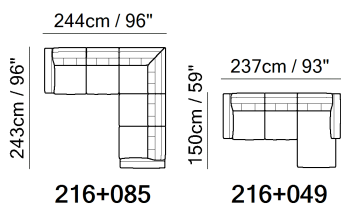

SCHEMATICS



COMPOSITION EXAMPLES



TECHNICAL INFORMATION

	<b>COVERING</b>	Leather <input checked="" type="checkbox"/>	Soft Cover <input checked="" type="checkbox"/>			
	<b>FILLING</b>	Arms <input type="checkbox"/> Fiber <input checked="" type="checkbox"/> Foam <input type="checkbox"/> Feather/Fiber Mix <input type="checkbox"/> Feather	Seat cushion <input type="checkbox"/> Fiber <input checked="" type="checkbox"/> Foam <input type="checkbox"/> Feather/Fiber Mix <input type="checkbox"/> Feather	Back cushion <input type="checkbox"/> Fiber <input checked="" type="checkbox"/> Foam <input type="checkbox"/> Feather/Fiber Mix <input type="checkbox"/> Feather		
	<b>COMFORT</b>	Firm Comfort <input type="checkbox"/>	Standard Comfort <input checked="" type="checkbox"/>			
	<b>FUNCTION</b>	Bed <input type="checkbox"/>	Electric motion <input type="checkbox"/>	Motion <input type="checkbox"/>	Recliner <input type="checkbox"/>	Sliding <input type="checkbox"/>
	<b>VISUAL APPEARANCE*</b>	Low <input checked="" type="checkbox"/>	Medium <input type="checkbox"/>	High <input type="checkbox"/>		
	<b>LEGS</b>	Metal <input checked="" type="checkbox"/>	Wood <input type="checkbox"/>	Castors <input type="checkbox"/>	Plastic <input type="checkbox"/>	Upholstered <input type="checkbox"/>

VISUAL APPEARANCE

The product may reveal various wrinkles due to the combination of Elasticity of the covering, characteristics of the interior construction and the design of the product.



Products with Visual Appearance listed as High or Medium would require higher degree of care, where seats and back cushions may require fluffing and plumping more often than Products with Visual Appearance listed as Low.

NOTES

- All arms, back and seat surfaces are covered in Top Grain.
- Available in leather or fabric.
- This model is available with split leather exterior covering (Side, Rear and Front Panels)
- Tight Seat Cushion (the seat cushions of the models are fixed to the frame)
- Tight Back Cushion (the back cushions of the models are fixed to the frame)
- Internal wooden frame.
- Feet will be in a bag inside the package and requires assembling.
- The model will be wrapped in a plastic bag.
- Feet available in metal finishings 77 (Glossy Chromed) / 79 (Matte Black)
- Feet height 13,0 cm

NOTES

---



■ Vers. T66



■ Vers. 182+049



■ Vers. 072+076+001+402



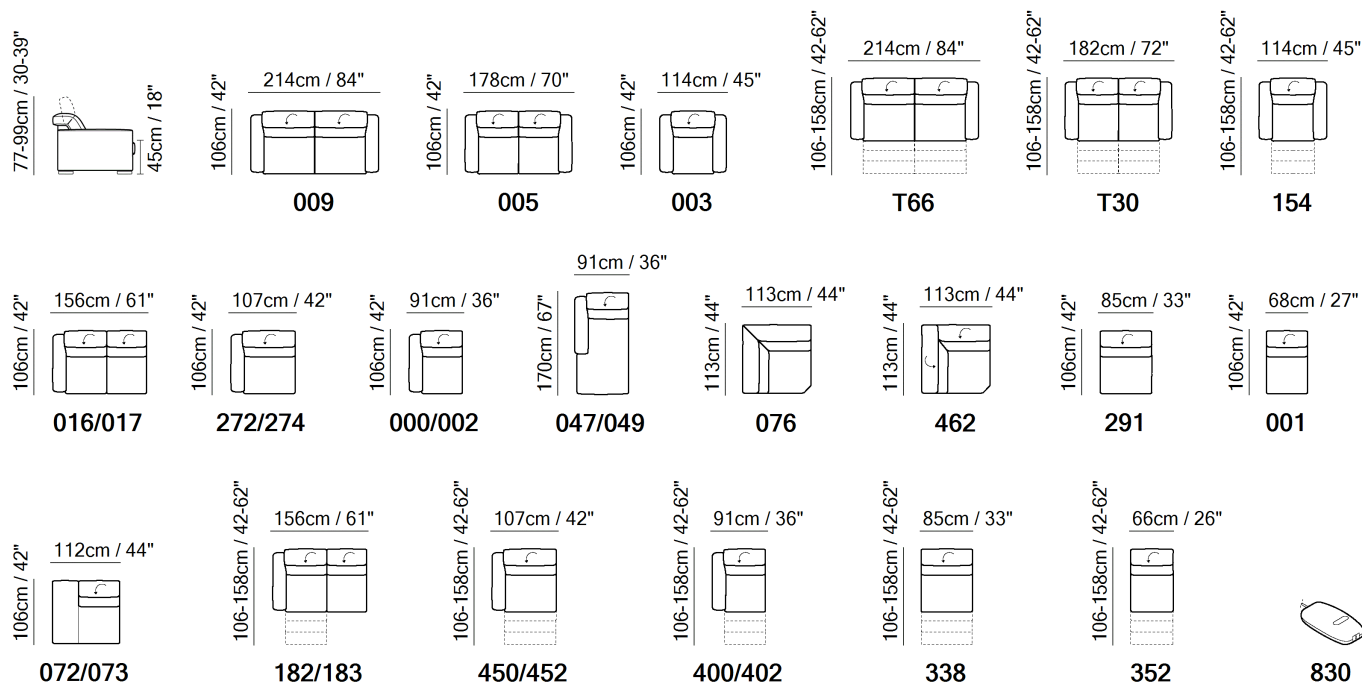

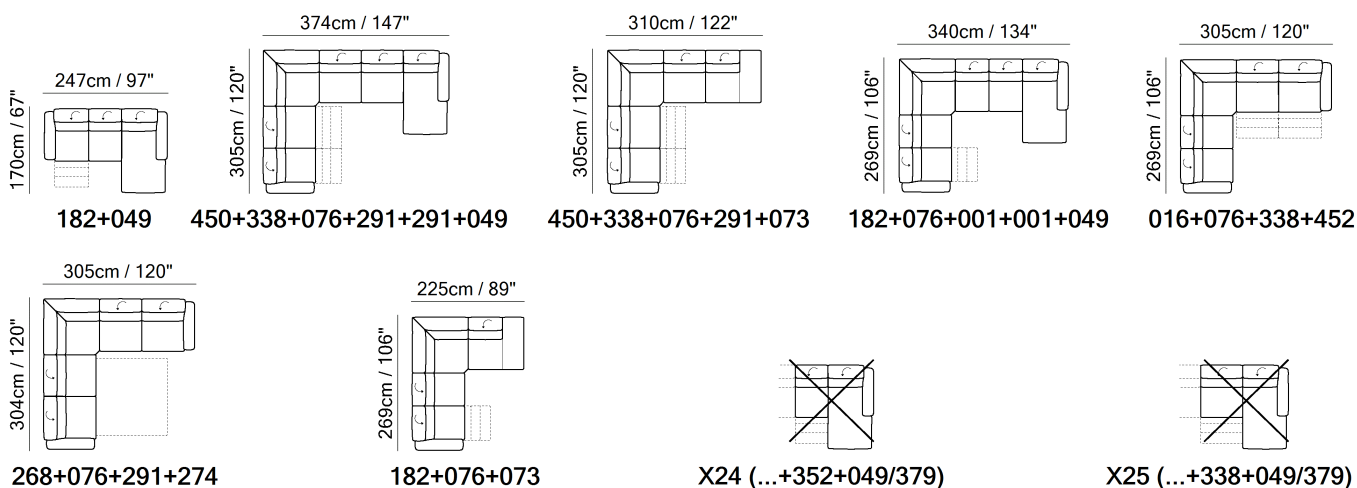

SCHEMATICS



COMPOSITION EXAMPLES



TECHNICAL INFORMATION

	<b>COVERING</b>	Leather <input checked="" type="checkbox"/>	Soft Cover <input checked="" type="checkbox"/>				
	<b>FILLING</b>	Arms	<input type="checkbox"/> Fiber <input checked="" type="checkbox"/> Foam <input type="checkbox"/> Feather/Fiber Mix <input type="checkbox"/> Feather	Seat cushion	<input type="checkbox"/> Fiber <input checked="" type="checkbox"/> Foam <input type="checkbox"/> Feather/Fiber Mix <input type="checkbox"/> Feather	Back cushion	<input type="checkbox"/> Fiber <input checked="" type="checkbox"/> Foam <input type="checkbox"/> Feather/Fiber Mix <input type="checkbox"/> Feather
	<b>COMFORT</b>	Standard Comfort <input checked="" type="checkbox"/>	Firm Comfort <input checked="" type="checkbox"/>				
	<b>FUNCTION</b>	Bed <input type="checkbox"/>	Electric motion <input checked="" type="checkbox"/>	Motion <input checked="" type="checkbox"/>	Recliner <input checked="" type="checkbox"/>	Sliding <input type="checkbox"/>	
	<b>VISUAL APPEARANCE*</b>	Low <input checked="" type="checkbox"/>	Medium <input type="checkbox"/>	High <input type="checkbox"/>			
	<b>LEGS</b>	Wood <input type="checkbox"/>	Metal <input type="checkbox"/>	Upholstered <input type="checkbox"/>	Plastic <input checked="" type="checkbox"/>	Castors <input type="checkbox"/>	

VISUAL APPEARANCE

The product may reveal various wrinkles due to the combination of Elasticity of the covering, characteristics of the interior construction and the design of the product.



Products with Visual Appearance listed as High or Medium would require higher degree of care, where seats and back cushions may require fluffing and plumping more often than Products with Visual Appearance listed as Low.

NOTES

- Available in leather (TG only) or fabric.
- Model is available with contrast welt (or any another decorative detail such as a band under arm cushion) to be entered as second covering in the same category.
- FABRIC: In fabric contrast welt (or any another decorative detail such as a band under arm cushion) can be made either in same category fabric or in leather with any color of Le Mans (only).
- The power switch is located on the external side panel which also allocates a USB charging port.
- A battery pack can be ordered with its own version code 830. For order entry please use XX for category and XXX for cover code. In order to optimize the duration of the battery, it is suggested to order one per each motion seat.
- Tight Seat Cushion (the seat cushions of the models are fixed to the frame)
- Tight Back Cushion (the back cushions of the models are fixed to the frame)
- No Leather/Fabric Side (the sectional pieces have the side covered with lining and not leather nor fabric)
- Internal wooden frame.
- Feet will be in a bag inside the package and requires assembling.
- The model will be wrapped in a plastic bag.

## NOTES

---

- Feet height 5,0 cm



■ Vers. 003



■ Vers. 003



■ Vers. 003



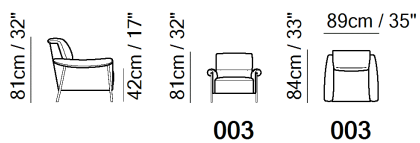

SCHEMATICS

---



## TECHNICAL INFORMATION

---

	<b>COVERING</b>	Leather <input checked="" type="checkbox"/>	Soft Cover <input checked="" type="checkbox"/>				
	<b>FILLING</b>	Arms	<input type="checkbox"/> Fiber <input checked="" type="checkbox"/> Foam <input type="checkbox"/> Feather/Fiber Mix <input type="checkbox"/> Feather	Seat cushion	<input type="checkbox"/> Fiber <input checked="" type="checkbox"/> Foam <input type="checkbox"/> Feather/Fiber Mix <input type="checkbox"/> Feather	Back cushion	<input type="checkbox"/> Fiber <input checked="" type="checkbox"/> Foam <input type="checkbox"/> Feather/Fiber Mix <input type="checkbox"/> Feather
	<b>COMFORT</b>	Firm Comfort <input type="checkbox"/>	Standard Comfort <input checked="" type="checkbox"/>				
	<b>FUNCTION</b>	Bed <input type="checkbox"/>	Electric motion <input type="checkbox"/>	Motion <input type="checkbox"/>	Recliner <input type="checkbox"/>	Sliding <input type="checkbox"/>	
	<b>LEGS</b>	Metal <input checked="" type="checkbox"/>	Wood <input type="checkbox"/>	Castors <input type="checkbox"/>	Plastic <input type="checkbox"/>	Upholstered <input type="checkbox"/>	

## NOTES

---

- Available in leather (TG only) or fabric.
- Tight Seat Cushion (the seat cushions of the models are fixed to the frame)
- Tight Back Cushion (the back cushions of the models are fixed to the frame)
- Internal wooden frame.
- Feet will be in a bag inside the package and requires assembling.
- The model will be wrapped in a plastic bag.
- Feet available in metal finishing 78 (Black Chrome)
- Feet height 15,0 cm

**NOTES**

---



■ Vers. 066



■ Vers. 066





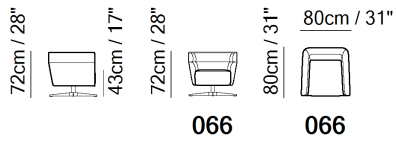

■ Vers. 066

## SCHEMATICS

---



TECHNICAL INFORMATION

	<b>COVERING</b>	Leather <input checked="" type="checkbox"/>	Soft Cover <input checked="" type="checkbox"/>				
	<b>FILLING</b>	Arms	<input type="checkbox"/> Fiber <input checked="" type="checkbox"/> Foam <input type="checkbox"/> Feather/Fiber Mix <input type="checkbox"/> Feather	Seat cushion	<input type="checkbox"/> Fiber <input checked="" type="checkbox"/> Foam <input type="checkbox"/> Feather/Fiber Mix <input type="checkbox"/> Feather	Back cushion	<input type="checkbox"/> Fiber <input checked="" type="checkbox"/> Foam <input type="checkbox"/> Feather/Fiber Mix <input type="checkbox"/> Feather
	<b>COMFORT</b>	Standard Comfort <input checked="" type="checkbox"/>	Firm Comfort <input type="checkbox"/>				
	<b>FUNCTION</b>	Bed <input type="checkbox"/>	Electric motion <input type="checkbox"/>	Motion <input type="checkbox"/>	Recliner <input type="checkbox"/>	Sliding <input type="checkbox"/>	
	<b>LEGS</b>	Wood <input type="checkbox"/>	Metal <input checked="" type="checkbox"/>	Upholstered <input type="checkbox"/>	Plastic <input type="checkbox"/>	Castors <input type="checkbox"/>	

NOTES

- Available in leather (TG only) or fabric.
- Model is available with contrast welt (or any another decorative detail such as a band under arm cushion) to be entered as second covering in the same category.
- FABRIC: In fabric contrast welt (as well as any another decorative detail such as a band under arm cushion or backrest or inserts) can be made with any color of art. Le Mans.
- Tight Seat Cushion (the seat cushions of the models are fixed to the frame)
- Tight Back Cushion (the back cushions of the models are fixed to the frame)
- Internal wooden frame.
- Feet will be in a bag inside the package and requires assembling.
- Packaging: Cardboard wrap.
- Metal base available in metal finishings 75 (Glazed Nickel) / 78 (Black Chrome)
- Feet height 17,0 cm

## NOTES

---



■ Vers. 355



■ Vers. 458



■ Vers. 514+638+029+291+291+049

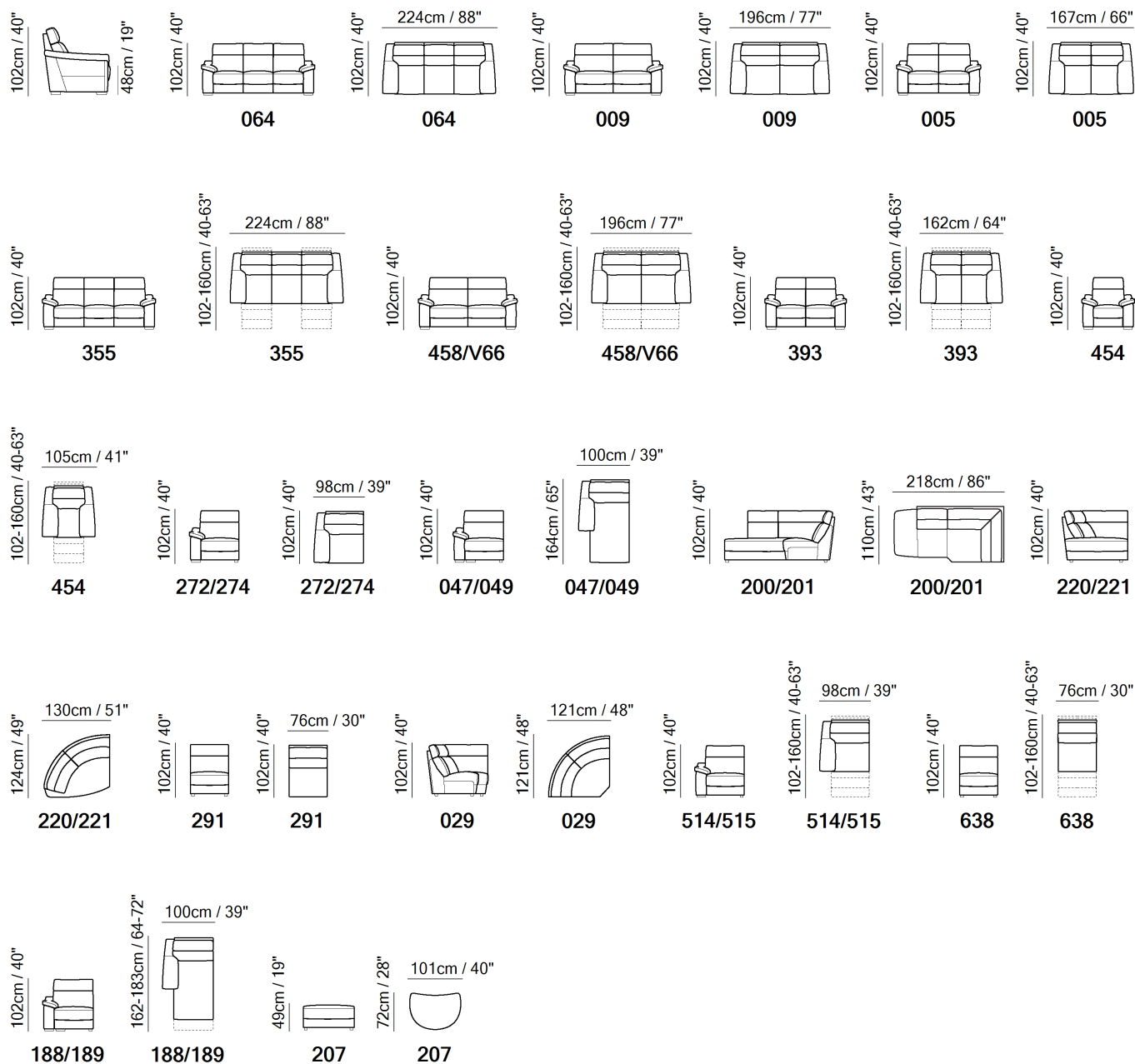

SCHEMATICS

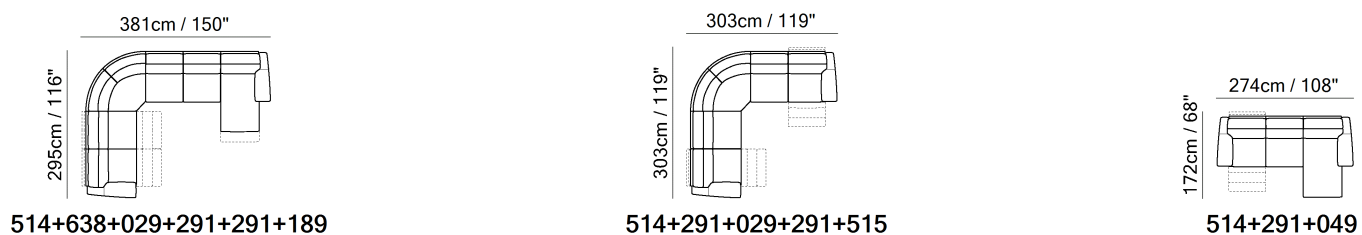

COMPOSITION EXAMPLES



TECHNICAL INFORMATION

	<b>COVERING</b>	Leather <input checked="" type="checkbox"/>	Soft Cover <input checked="" type="checkbox"/>				
	<b>FILLING</b>	Arms	<input checked="" type="checkbox"/> Fiber <input type="checkbox"/> Foam <input type="checkbox"/> Feather/Fiber Mix <input type="checkbox"/> Feather	Seat cushion	<input type="checkbox"/> Fiber <input checked="" type="checkbox"/> Foam <input type="checkbox"/> Feather/Fiber Mix <input type="checkbox"/> Feather	Back cushion	<input checked="" type="checkbox"/> Fiber <input type="checkbox"/> Foam <input type="checkbox"/> Feather/Fiber Mix <input type="checkbox"/> Feather
	<b>COMFORT</b>	Firm Comfort <input checked="" type="checkbox"/>	Standard Comfort <input checked="" type="checkbox"/>				
	<b>FUNCTION</b>	Bed <input type="checkbox"/>	Electric motion <input checked="" type="checkbox"/>	Motion <input checked="" type="checkbox"/>	Recliner <input checked="" type="checkbox"/>	Sliding <input type="checkbox"/>	
	<b>VISUAL APPEARANCE*</b>	Low <input checked="" type="checkbox"/>	Medium <input type="checkbox"/>	High <input type="checkbox"/>			
	<b>LEGS</b>	Metal <input type="checkbox"/>	Wood <input type="checkbox"/>	Castors <input type="checkbox"/>	Plastic <input checked="" type="checkbox"/>	Upholstered <input type="checkbox"/>	

VISUAL APPEARANCE

The product may reveal various wrinkles due to the combination of Elasticity of the covering, characteristics of the interior construction and the design of the product.



Products with Visual Appearance listed as High or Medium would require higher degree of care, where seats and back cushions may require fluffing and plumping more often than Products with Visual Appearance listed as Low.

NOTES

- Available in leather or fabric.
- Contrast stitching is available only with certain covers and option is managed directly in NARES.
- All arms, back and seat surfaces are covered in Top Grain.
- This model is available with split leather exterior covering (Side, Rear and Front Panels)
- Dual power mechanism with external switch on the side panel that activates recliner and headrest and includes an USB charging port
- A battery pack can be ordered with its own version code 830. For order entry please use XX for category and XXX for cover code. In order to optimize the duration of the battery, it is suggested to order one per each motion seat.
- Tight Seat Cushion (the seat cushions of the models are fixed to the frame)
- Tight Back Cushion (the back cushions of the models are fixed to the frame)
- Internal wooden frame.
- Feet will be in a bag inside the package and requires assembling.
- The model will be wrapped in a plastic bag.
- The leg is plastic with finishing 18 (wengè wood effect)
- Feet height 4,5 cm

NOTES

---



■ Vers. 064



■ Vers. 480+289



■ Vers. 154



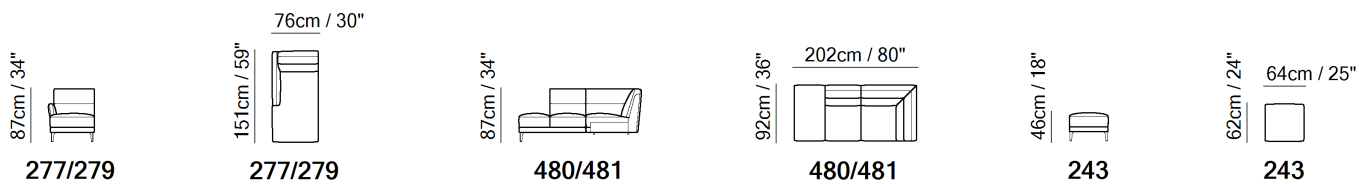
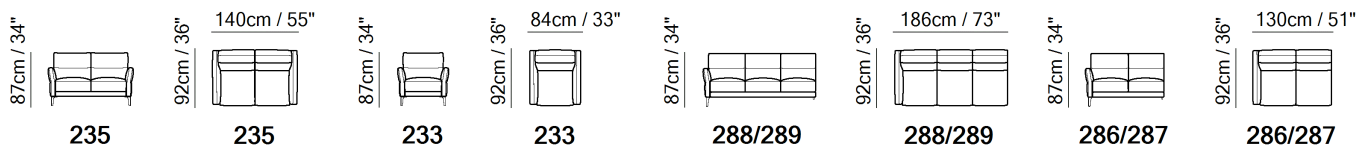
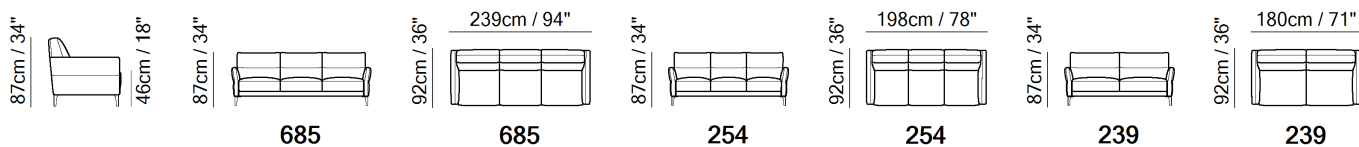
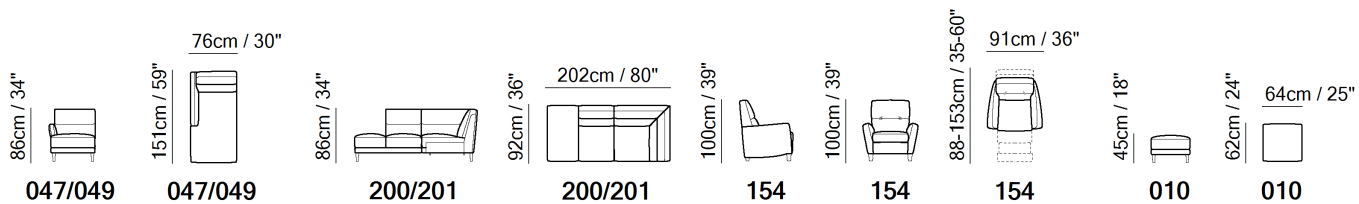
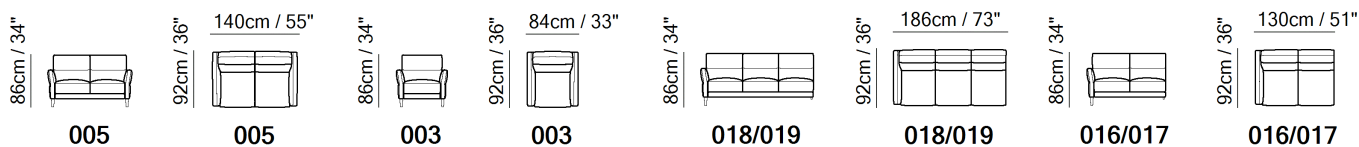
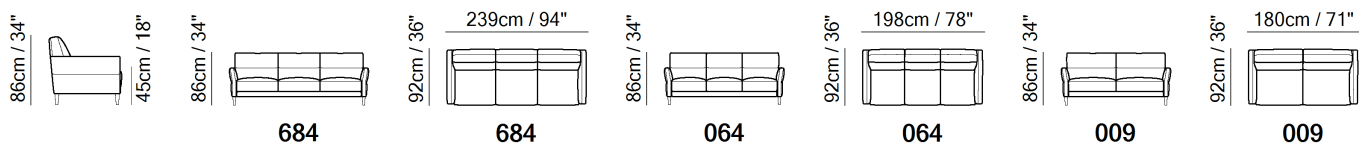

SCHEMATICS

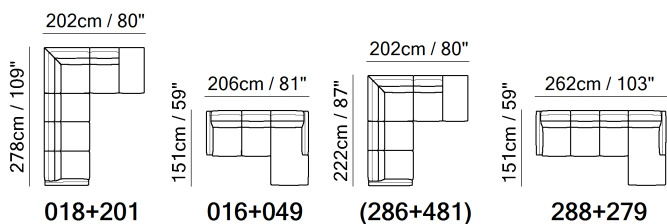

COMPOSITION EXAMPLES



**TECHNICAL INFORMATION**

	<b>COVERING</b>	Leather <input checked="" type="checkbox"/>	Soft Cover <input checked="" type="checkbox"/>				
	<b>FILLING</b>	Arms	<input type="checkbox"/> Fiber <input checked="" type="checkbox"/> Foam <input type="checkbox"/> Feather/Fiber Mix <input type="checkbox"/> Feather	Seat cushion	<input type="checkbox"/> Fiber <input checked="" type="checkbox"/> Foam <input type="checkbox"/> Feather/Fiber Mix <input type="checkbox"/> Feather	Back cushion	<input type="checkbox"/> Fiber <input checked="" type="checkbox"/> Foam <input type="checkbox"/> Feather/Fiber Mix <input type="checkbox"/> Feather
	<b>COMFORT</b>	Standard Comfort <input checked="" type="checkbox"/>	Firm Comfort <input type="checkbox"/>				
	<b>FUNCTION</b>	Bed <input type="checkbox"/>	Electric motion <input checked="" type="checkbox"/>	Motion <input type="checkbox"/>	Recliner <input checked="" type="checkbox"/>	Sliding <input type="checkbox"/>	
	<b>LEGS</b>	Wood <input type="checkbox"/>	Metal <input checked="" type="checkbox"/>	Upholstered <input type="checkbox"/>	Plastic <input checked="" type="checkbox"/>	Castors <input type="checkbox"/>	

**NOTES**

- Available in leather or fabric.
- Contrast stitching is available only with certain covers and option is managed directly in NARES.
- All arms, back and seat surfaces are covered in Top Grain.
- This model is available with split leather exterior covering (Side, Rear and Front Panels)
- Tight Seat Cushion (the seat cushions of the models are fixed to the frame)
- Tight Back Cushion (the back cushions of the models are fixed to the frame)
- Internal wooden frame.
- Feet will be in a bag inside the package and requires assembling.
- The model will be wrapped in a plastic bag.
- The leg is plastic with finishing 18 (wengè wood effect)
- Second option versions have metal legs available with matt black (79) or metal gold (90) finishings
- Feet height 14,0 cm

NOTES

---



■ Vers. 009



■ Vers. 009



■ Vers. 018+201



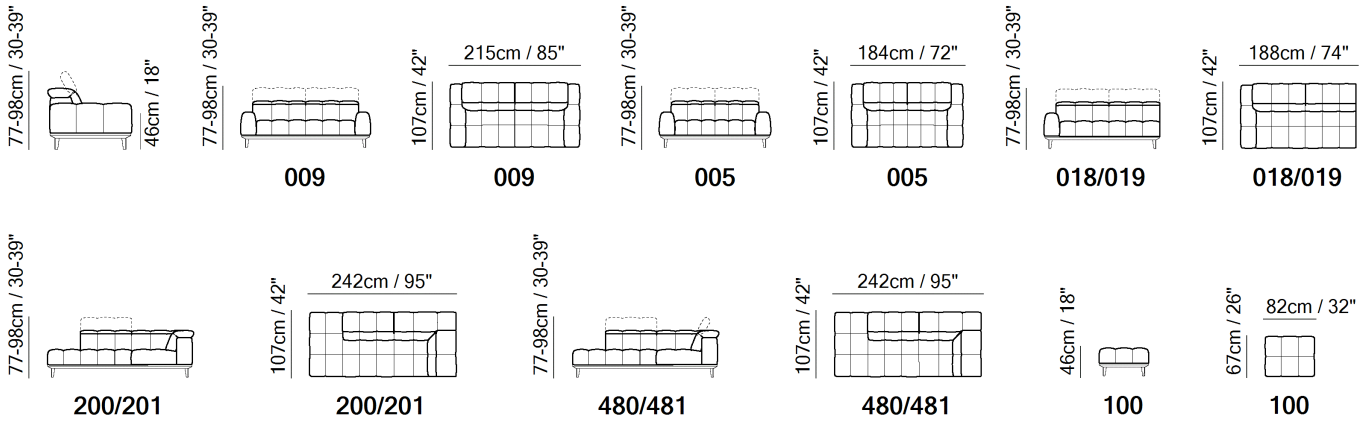

SCHEMATICS

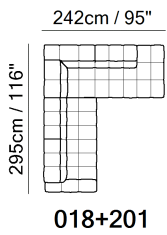

COMPOSITION EXAMPLES



## TECHNICAL INFORMATION

	<b>COVERING</b>	Leather <input checked="" type="checkbox"/>	Soft Cover <input checked="" type="checkbox"/>				
	<b>FILLING</b>	Arms	<input type="checkbox"/> Fiber <input checked="" type="checkbox"/> Foam <input type="checkbox"/> Feather/Fiber Mix <input type="checkbox"/> Feather	Seat cushion	<input type="checkbox"/> Fiber <input checked="" type="checkbox"/> Foam <input type="checkbox"/> Feather/Fiber Mix <input type="checkbox"/> Feather	Back cushion	<input type="checkbox"/> Fiber <input checked="" type="checkbox"/> Foam <input type="checkbox"/> Feather/Fiber Mix <input type="checkbox"/> Feather
	<b>COMFORT</b>	Firm Comfort <input type="checkbox"/>	Standard Comfort <input checked="" type="checkbox"/>				
	<b>FUNCTION</b>	Bed <input type="checkbox"/>	Electric motion <input type="checkbox"/>	Motion <input type="checkbox"/>	Recliner <input type="checkbox"/>	Sliding <input type="checkbox"/>	
	<b>LEGS</b>	Metal <input type="checkbox"/>	Wood <input checked="" type="checkbox"/>	Castors <input type="checkbox"/>	Plastic <input type="checkbox"/>	Upholstered <input type="checkbox"/>	

## NOTES

- Available in leather (TG only) or fabric.
- Tight Seat Cushion (the seat cushions of the models are fixed to the frame)
- Tight Back Cushion (the back cushions of the models are fixed to the frame)
- No Leather/Fabric Side (the sectional pieces have the side covered with lining and not leather nor fabric)
- Internal wooden frame.
- Feet will be in a bag inside the package and requires assembling.
- Packaging: Cardboard wrap.
- Wooden base and legs available in finishing 09 (Walnut) / 18 (Wengè)
- Feet height 20,0 cm

**NOTES**

---



■ Vers. 009



■ Vers. T66



■ Vers. 072+489+483



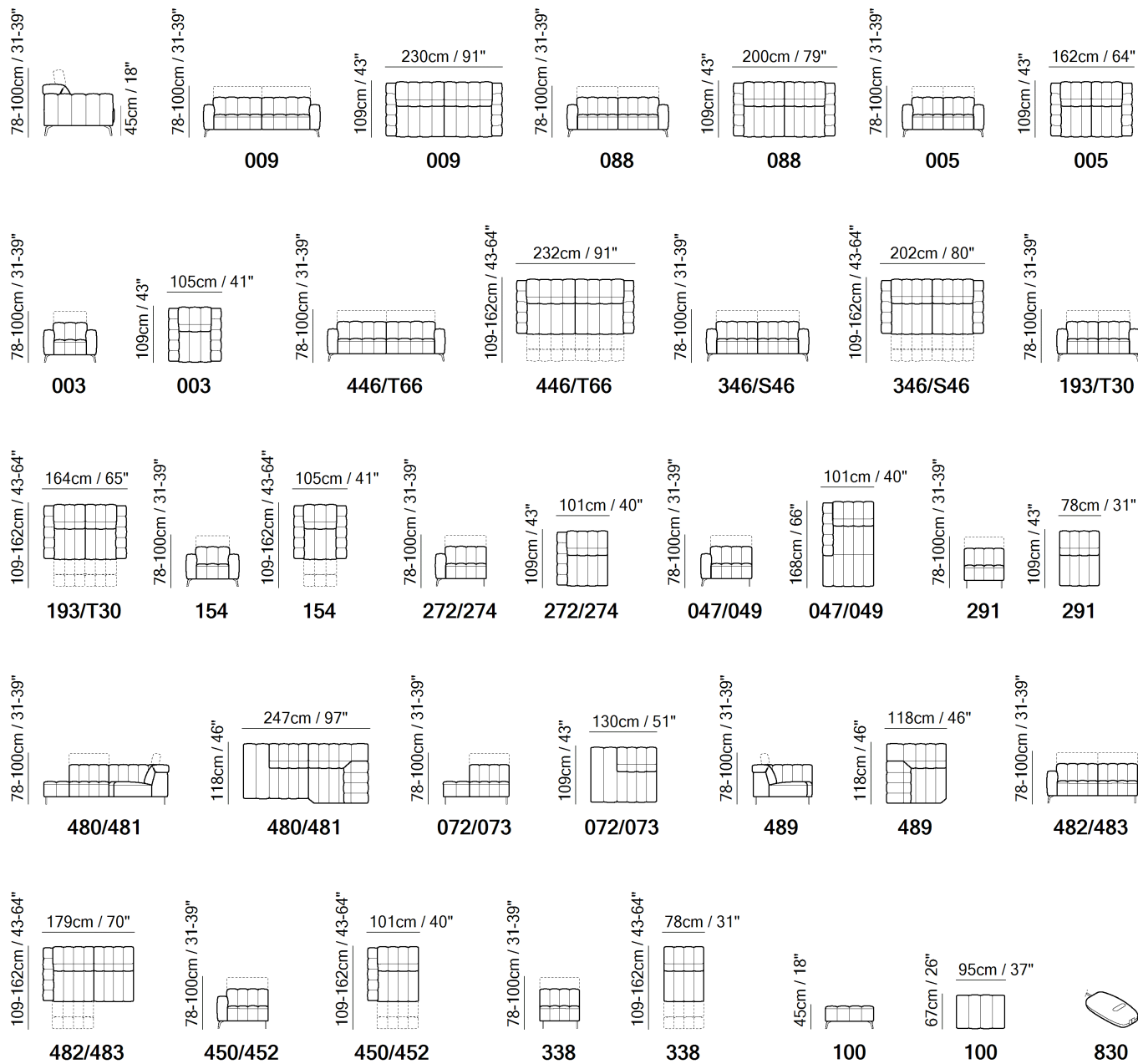

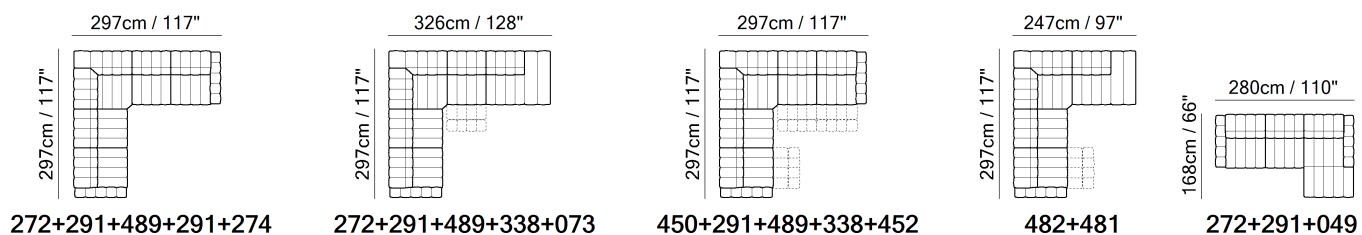

SCHEMATICS



COMPOSITION EXAMPLES



TECHNICAL INFORMATION

	<b>COVERING</b>	Leather <input checked="" type="checkbox"/>	Soft Cover <input checked="" type="checkbox"/>				
	<b>FILLING</b>	Arms	<input type="checkbox"/> Fiber <input checked="" type="checkbox"/> Foam <input type="checkbox"/> Feather/Fiber Mix <input type="checkbox"/> Feather	Seat cushion	<input type="checkbox"/> Fiber <input checked="" type="checkbox"/> Foam <input type="checkbox"/> Feather/Fiber Mix <input type="checkbox"/> Feather	Back cushion	<input type="checkbox"/> Fiber <input checked="" type="checkbox"/> Foam <input type="checkbox"/> Feather/Fiber Mix <input type="checkbox"/> Feather
	<b>COMFORT</b>	Standard Comfort <input checked="" type="checkbox"/>	Firm Comfort <input checked="" type="checkbox"/>				
	<b>FUNCTION</b>	Bed <input type="checkbox"/>	Electric motion <input checked="" type="checkbox"/>	Motion <input checked="" type="checkbox"/>	Recliner <input checked="" type="checkbox"/>	Sliding <input type="checkbox"/>	
	<b>VISUAL APPEARANCE*</b>	Low <input checked="" type="checkbox"/>	Medium <input type="checkbox"/>	High <input type="checkbox"/>			
	<b>LEGS</b>	Wood <input type="checkbox"/>	Metal <input checked="" type="checkbox"/>	Metal <input checked="" type="checkbox"/>	Upholstered <input type="checkbox"/>	Plastic <input type="checkbox"/>	
		Castors <input type="checkbox"/>					

VISUAL APPEARANCE

The product may reveal various wrinkles due to the combination of Elasticity of the covering, characteristics of the interior construction and the design of the product.



Products with Visual Appearance listed as High or Medium would require higher degree of care, where seats and back cushions may require fluffing and plumping more often than Products with Visual Appearance listed as Low.

NOTES

- Available in leather (TG only) or fabric.
- Ergocert Certified. Human-Centered Design certification by Ergocert, is the first European ergonomics certification body. This certification guarantees that the entire design and production process has been completed by listening to the needs of the end user to create and offer an effective and unique comfort experience.
- Dual power mechanism with external switch on the side panel that activates recliner and headrest and includes an USB charging port
- A battery pack can be ordered with its own version code 830. For order entry please use XX for category and XXX for cover code. In order to optimize the duration of the battery, it is suggested to order one per each motion seat.
- Tight Seat Cushion (the seat cushions of the models are fixed to the frame)
- Tight Back Cushion (the back cushions of the models are fixed to the frame)
- Internal wooden frame.
- Feet will be in a bag inside the package and requires assembling.
- Packaging: Cardboard wrap.
- Feet available in metal finishings 77 (Glossy Chromed) / 79 (Matte Black)
- Feet height 15,5 cm

NOTES

---



■ Vers. T66



■ Vers. 482+481



■ Vers. 482+489+291+274



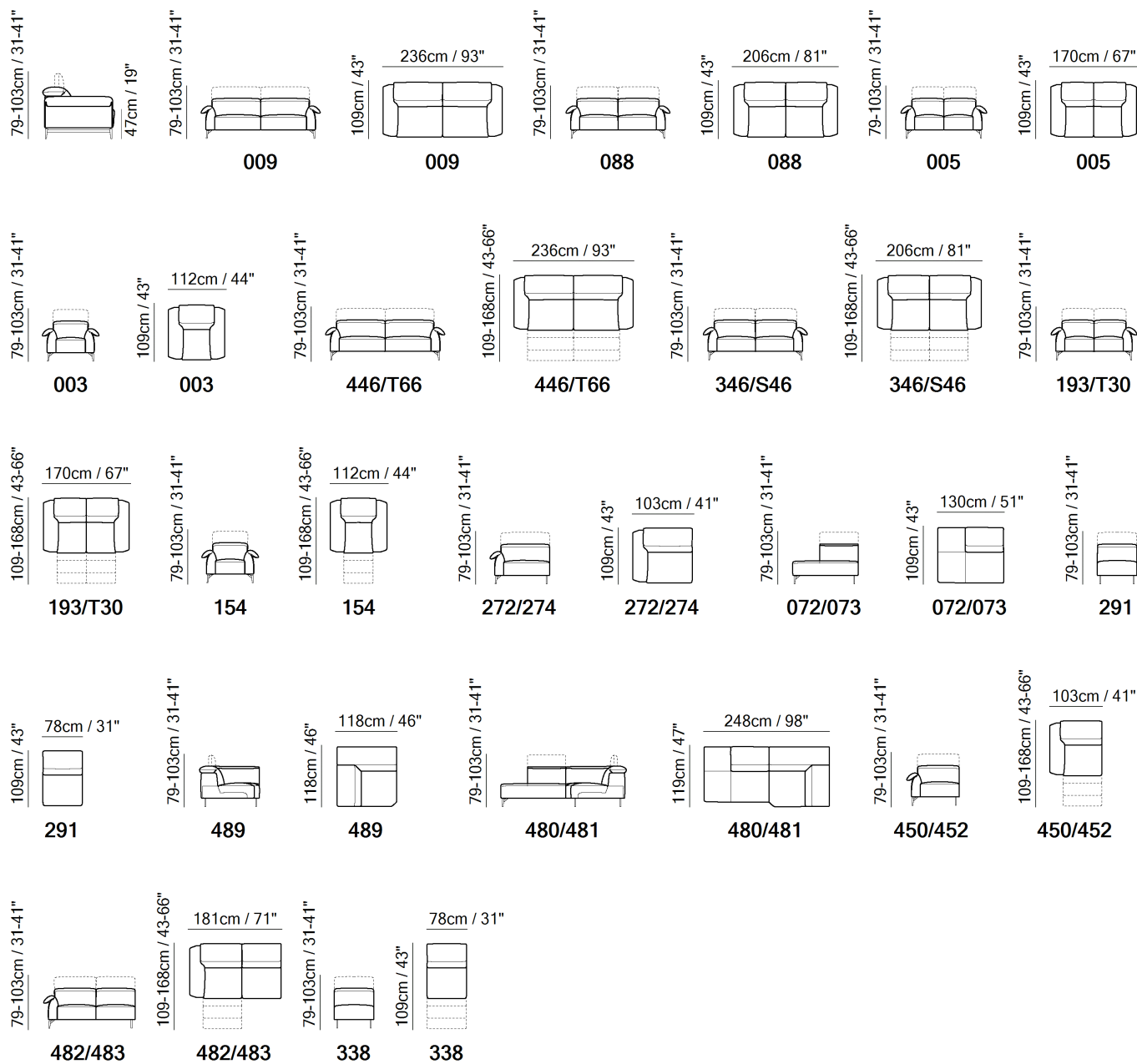

SCHEMATICS

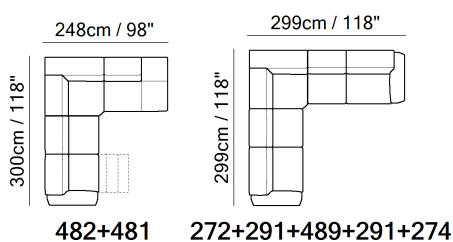

COMPOSITION EXAMPLES



TECHNICAL INFORMATION

	<b>COVERING</b>	Leather <input checked="" type="checkbox"/>	Soft Cover <input checked="" type="checkbox"/>			
	<b>FILLING</b>	Arms <input type="checkbox"/> Fiber <input checked="" type="checkbox"/> Foam <input type="checkbox"/> Feather/Fiber Mix <input type="checkbox"/> Feather	Seat cushion <input type="checkbox"/> Fiber <input checked="" type="checkbox"/> Foam <input type="checkbox"/> Feather/Fiber Mix <input type="checkbox"/> Feather	Back cushion <input type="checkbox"/> Fiber <input checked="" type="checkbox"/> Foam <input type="checkbox"/> Feather/Fiber Mix <input type="checkbox"/> Feather		
	<b>COMFORT</b>	Firm Comfort <input checked="" type="checkbox"/>	Standard Comfort <input checked="" type="checkbox"/>			
	<b>FUNCTION</b>	Bed <input type="checkbox"/>	Electric motion <input checked="" type="checkbox"/>	Motion <input checked="" type="checkbox"/>	Recliner <input checked="" type="checkbox"/>	Sliding <input type="checkbox"/>
	<b>VISUAL APPEARANCE*</b>	Low <input checked="" type="checkbox"/>	Medium <input type="checkbox"/>	High <input type="checkbox"/>		
	<b>LEGS</b>	Metal <input checked="" type="checkbox"/>	Wood <input type="checkbox"/>	Castors <input type="checkbox"/>	Plastic <input type="checkbox"/>	Upholstered <input type="checkbox"/>

VISUAL APPEARANCE

The product may reveal various wrinkles due to the combination of Elasticity of the covering, characteristics of the interior construction and the design of the product.



Products with Visual Appearance listed as High or Medium would require higher degree of care, where seats and back cushions may require fluffing and plumping more often than Products with Visual Appearance listed as Low.

NOTES

- Available in leather (TG only) or fabric.
- FABRIC: In fabric contrast welt (as well as any another decorative detail such as a band under arm cushion or backrest or inserts) can be made with any color of art. Le Mans.
- Ergocert Certified. Human-Centered Design certification by Ergocert, is the first European ergonomics certification body. This certification guarantees that the entire design and production process has been completed by listening to the needs of the end user to create and offer an effective and unique comfort experience.
- Dual power mechanism with external switch on the side panel that activates recliner and headrest and includes an USB charging port
- A battery pack can be ordered with its own version code 830. For order entry please use XX for category and XXX for cover code. In order to optimize the duration of the battery, it is suggested to order one per each motion seat.
- Tight Seat Cushion (the seat cushions of the models are fixed to the frame)
- Tight Back Cushion (the back cushions of the models are fixed to the frame)
- No Leather/Fabric Side (the sectional pieces have the side covered with lining and not leather nor fabric)
- Internal wooden frame.
- Feet will be in a bag inside the package and requires assembling.
- Packaging: Cardboard wrap.

## NOTES

---

- Feet available in metal finishing 79 (Matte Black)
- Feet height 17,0 cm



■ Vers. 450+338+452



■ Vers. 450+338+452



■ Vers. 450+338+291+011+291+049



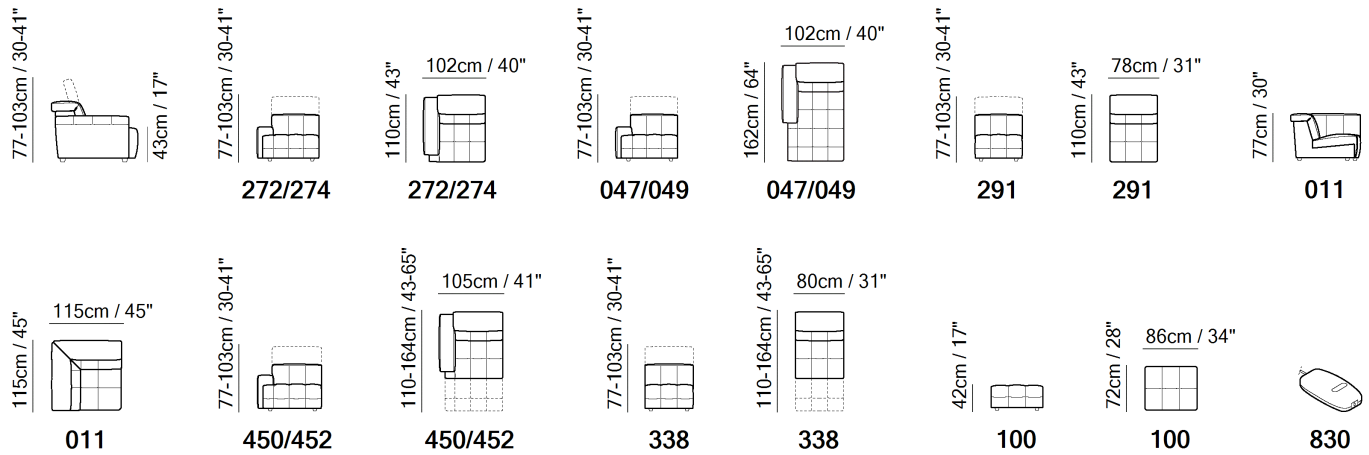

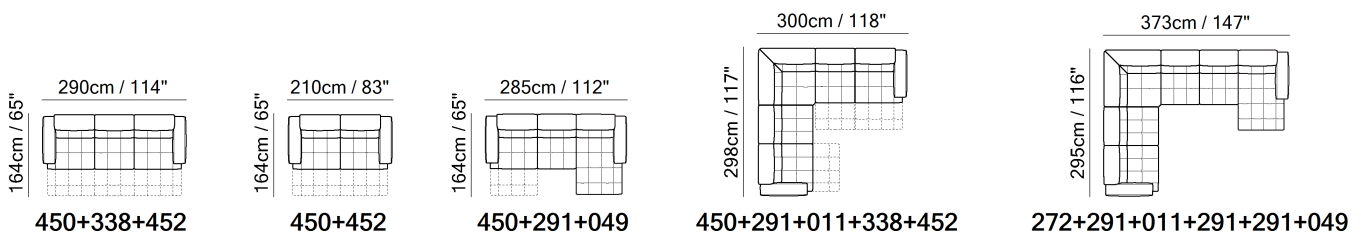

SCHEMATICS



COMPOSITION EXAMPLES



TECHNICAL INFORMATION

	<b>COVERING</b>	Leather <input checked="" type="checkbox"/>	Soft Cover <input checked="" type="checkbox"/>			
	<b>FILLING</b>	Arms <input type="checkbox"/> Fiber <input checked="" type="checkbox"/> Foam <input type="checkbox"/> Feather/Fiber Mix <input type="checkbox"/> Feather	Seat cushion <input type="checkbox"/> Fiber <input checked="" type="checkbox"/> Foam <input type="checkbox"/> Feather/Fiber Mix <input type="checkbox"/> Feather	Back cushion <input type="checkbox"/> Fiber <input checked="" type="checkbox"/> Foam <input type="checkbox"/> Feather/Fiber Mix <input type="checkbox"/> Feather		
	<b>COMFORT</b>	Standard Comfort <input checked="" type="checkbox"/>	Firm Comfort <input checked="" type="checkbox"/>			
	<b>FUNCTION</b>	Bed <input type="checkbox"/>	Electric motion <input checked="" type="checkbox"/>	Motion <input type="checkbox"/>	Recliner <input type="checkbox"/>	Sliding <input type="checkbox"/>
	<b>VISUAL APPEARANCE*</b>	Low <input checked="" type="checkbox"/>	Medium <input type="checkbox"/>	High <input type="checkbox"/>		
	<b>LEGS</b>	Wood <input type="checkbox"/>	Metal <input type="checkbox"/>	Upholstered <input type="checkbox"/>	Plastic <input checked="" type="checkbox"/>	Castors <input type="checkbox"/>

VISUAL APPEARANCE

The product may reveal various wrinkles due to the combination of Elasticity of the covering, characteristics of the interior construction and the design of the product.



Products with Visual Appearance listed as High or Medium would require higher degree of care, where seats and back cushions may require fluffing and plumping more often than Products with Visual Appearance listed as Low.

NOTES

- Contrast stitching is available only with certain covers and option is managed directly in NARES.
- Dual power mechanism with external switch on the side panel that activates recliner and headrest and includes an USB charging port
- Stationary versions have manually adjustable headrests.
- A battery pack can be ordered with its own version code 830. For order entry please use XX for category and XXX for cover code. In order to optimize the duration of the battery, it is suggested to order one per each motion seat.
- All arms, back and seat surfaces are covered in Top Grain.
- This model is available with split leather exterior covering (Side, Rear and Front Panels)
- Tight Seat Cushion (the seat cushions of the models are fixed to the frame)
- Tight Back Cushion (the back cushions of the models are fixed to the frame)
- No Leather/Fabric Side (the sectional pieces have the side covered with lining and not leather nor fabric)
- Internal wooden frame.
- Feet will be in a bag inside the package and requires assembling.
- Packaging: plastic wrap for stationary versions and cardboard box for motion/sofabed versions

## NOTES

---

- Feet height 5,0 cm



■ Vers. 200+183



■ Vers. 200+183



■ Vers. 018+011+291+452



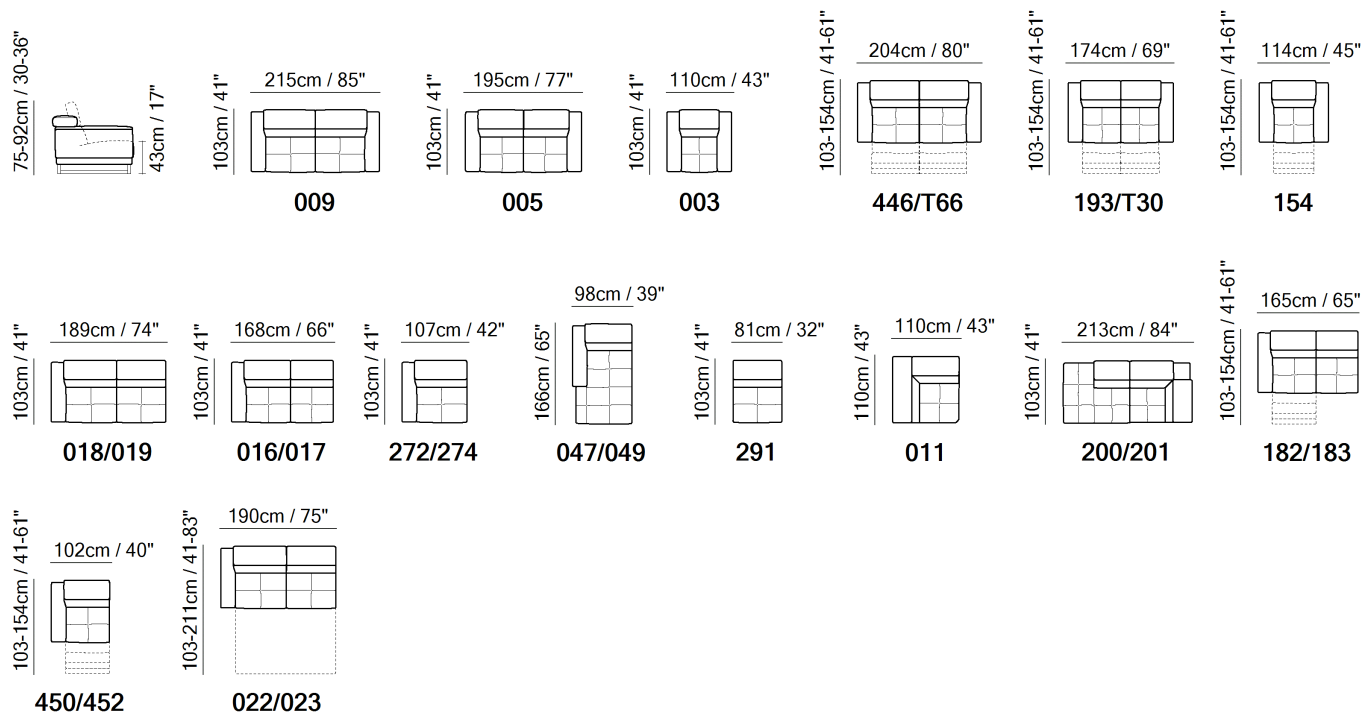

SCHEMATICS

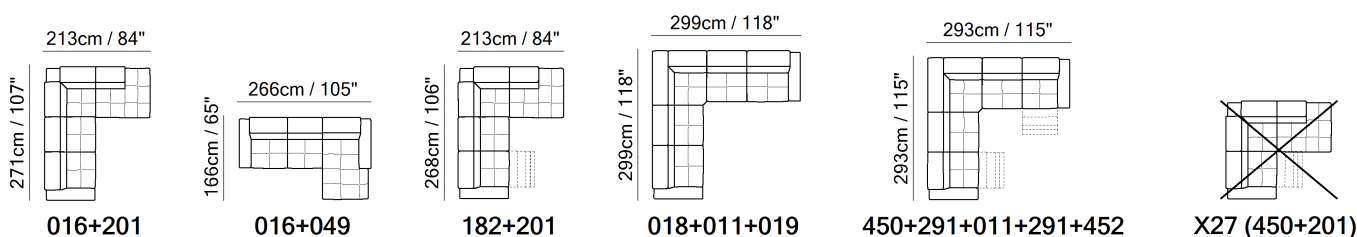

COMPOSITION EXAMPLES



TECHNICAL INFORMATION

	<b>COVERING</b>	Leather <input checked="" type="checkbox"/>	Soft Cover <input checked="" type="checkbox"/>				
	<b>FILLING</b>	Arms	<input type="checkbox"/> Fiber <input checked="" type="checkbox"/> Foam <input type="checkbox"/> Feather/Fiber Mix <input type="checkbox"/> Feather	Seat cushion	<input type="checkbox"/> Fiber <input checked="" type="checkbox"/> Foam <input type="checkbox"/> Feather/Fiber Mix <input type="checkbox"/> Feather	Back cushion	<input type="checkbox"/> Fiber <input checked="" type="checkbox"/> Foam <input type="checkbox"/> Feather/Fiber Mix <input type="checkbox"/> Feather
	<b>COMFORT</b>	Firm Comfort <input checked="" type="checkbox"/>	Standard Comfort <input checked="" type="checkbox"/>				
	<b>FUNCTION</b>	Bed <input checked="" type="checkbox"/>	Electric motion <input checked="" type="checkbox"/>	Motion <input checked="" type="checkbox"/>	Recliner <input checked="" type="checkbox"/>	Sliding <input type="checkbox"/>	
	<b>LEGS</b>	Metal <input checked="" type="checkbox"/>	Wood <input type="checkbox"/>	Castors <input type="checkbox"/>	Plastic <input type="checkbox"/>	Upholstered <input type="checkbox"/>	

BED MECHANISM & MATTRESS

MECHANISM		MATTRESS		
VERSIONS	TYPE	VERSIONS	TYPE	DIMENSIONS
022,023	Ready-Bed electro-welded - Double folding	022,023	Polyurethane foam	W L H 140 190 13

Ready-Bed electro-welded      The back cushion goes under the bed mechanism.

NOTES

- Contrast stitching is available only with certain covers and option is managed directly in NARES.
- The model has manual adjustable headrest.
- Model is available with contrast welt (or any another decorative detail such as a band under arm cushion) to be entered as second covering in the same category.
- The model has external switch on the side panel to activate the mechanism.
- A battery pack can be ordered with its own version code 830. For order entry please use XX for category and XXX for cover code. In order to optimize the duration of the battery, it is suggested to order one per each motion seat.
- All arms, back and seat surfaces are covered in Top Grain.
- This model is available with split leather exterior covering (Side, Rear and Front Panels)
- Tight Seat Cushion (the seat cushions of the models are fixed to the frame)
- Tight Back Cushion (the back cushions of the models are fixed to the frame)
- No Leather/Fabric Side (the sectional pieces have the side covered with lining and not leather nor fabric)
- Internal wooden frame.
- Feet will be in a bag inside the package and requires assembling.

## NOTES

---

- The model will be wrapped in a plastic bag.
- Feet available in metal finishings 77 (Glossy Chromed) / 79 (Matte Black)
- Feet height 12,0 cm



■ Vers. 216+379



■ Vers. 216+379



■ Vers. 216+379



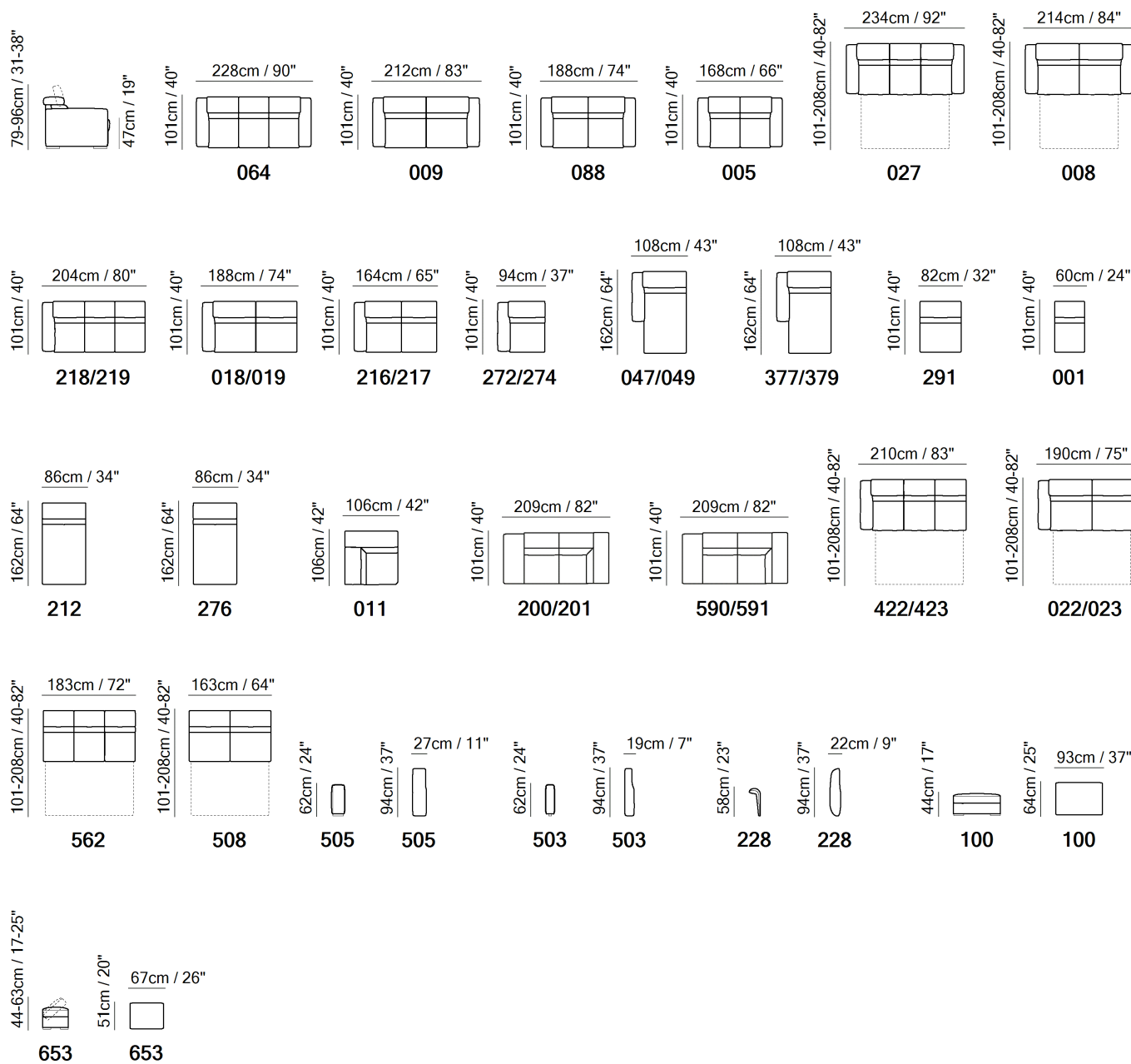

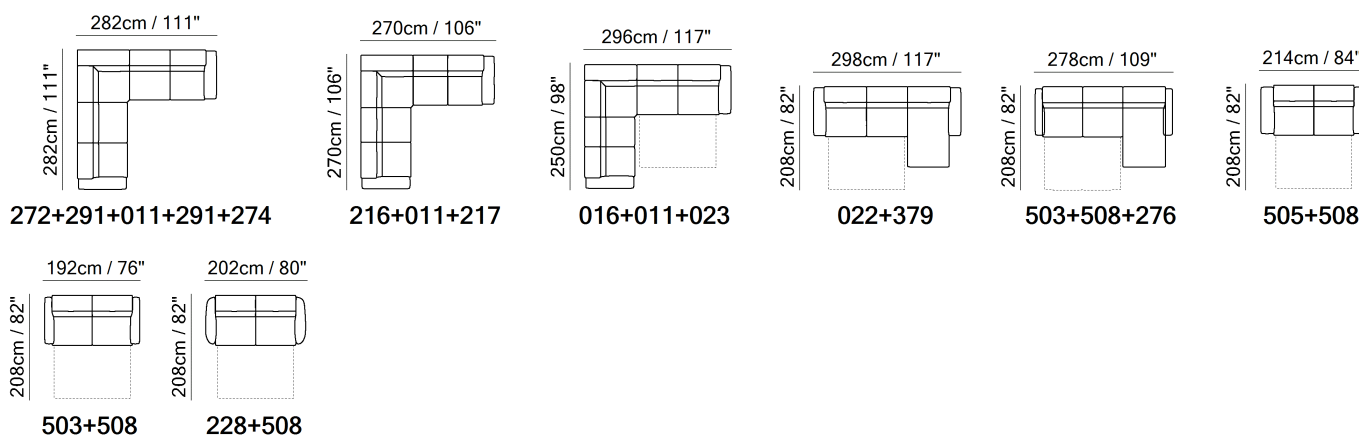

SCHEMATICS



COMPOSITION EXAMPLES



TECHNICAL INFORMATION

	<b>COVERING</b>	Leather <input checked="" type="checkbox"/>	Soft Cover <input checked="" type="checkbox"/>			
	<b>FILLING</b>	Arms <input type="checkbox"/> Fiber <input checked="" type="checkbox"/> Foam <input type="checkbox"/> Feather/Fiber Mix <input type="checkbox"/> Feather	Seat cushion <input type="checkbox"/> Fiber <input checked="" type="checkbox"/> Foam <input type="checkbox"/> Feather/Fiber Mix <input type="checkbox"/> Feather	Back cushion <input type="checkbox"/> Fiber <input checked="" type="checkbox"/> Foam <input type="checkbox"/> Feather/Fiber Mix <input type="checkbox"/> Feather		
	<b>COMFORT</b>	Standard Comfort <input checked="" type="checkbox"/>	Firm Comfort <input checked="" type="checkbox"/>			
	<b>FUNCTION</b>	Bed <input checked="" type="checkbox"/>	Electric motion <input type="checkbox"/>	Motion <input type="checkbox"/>	Recliner <input type="checkbox"/>	Sliding <input type="checkbox"/>
	<b>VISUAL APPEARANCE*</b>	Low <input checked="" type="checkbox"/>	Medium <input type="checkbox"/>	High <input type="checkbox"/>		
	<b>LEGS</b>	Wood <input checked="" type="checkbox"/>	Metal <input type="checkbox"/>	Upholstered <input type="checkbox"/>	Plastic <input type="checkbox"/>	Castors <input type="checkbox"/>

VISUAL APPEARANCE

The product may reveal various wrinkles due to the combination of Elasticity of the covering, characteristics of the interior construction and the design of the product.



Products with Visual Appearance listed as High or Medium would require higher degree of care, where seats and back cushions may require fluffing and plumping more often than Products with Visual Appearance listed as Low.

BED MECHANISM & MATTRESS

MECHANISM		MATTRESS		
VERSIONS	TYPE	VERSIONS	TYPE	DIMENSIONS
008,022,023,508	Ready-Bed electro-welded - Double folding	008,022,023,508	Polyurethane foam	W L H 140 190 13
027,422,423,562	Ready-Bed electro-welded - Double folding	027,422,423,562	Polyurethane foam	160 190 13

**Ready-Bed electro-welded** The back cushion goes under the bed mechanism.

NOTES

- Available in leather (TG only) or fabric.
- Contrast stitching is available only with certain covers and option is managed directly in NARES.
- For technical reasons, versions that provide fixed wide arm ( stationary, sofabed and chaise) can be combined only with versions: 218/219, 018/019, 216/217, 272/274, 047/049, 377/379, 292, 001, 011, 422/423, 022/023 as well as versions that provide the choice of the arm can be combined only among them: 562, 508, 212, 276, 228, 503, 505.
- All versions, except 011, have adjustable headrests in multiple positions.
- The levers are positioned on both sides: when you pull them forward two wheels under the lever lower and lift the front part of the sofabed to easily move it.
- Versions 508 and 562 are available with the lift lever option to be selected during the order entry phase with an upcharge available for all pricelists. By selecting the lift lever option, the metal legs of the bed mesh are replaced by small wheels.

## NOTES

- EMEA ONLY - Armless 3-seater sofas versions 508 (with double bed) and version 562 (with large double bed) can be ordered with new arm options:
  - 503 couple of square arms (right + left arms)
  - 505 couple of large square arms (right + left arms)
  - 228 couple of curved arms (right + left arms)Can be assembled only with versions 562-508-212-276
- Chaise longue dimensions without arms:
  - 212+503 (arm set) = 115 cm / 45,27"
  - 212+228 (arm set) = 125 cm / 49,21"
  - 212+505 (arm set) = 137 cm / 53,93"
- Corner Terminal can be ordered with or without storage:
  - Vers.200/201 corner terminal without storage
  - Vers.590/591 corner terminal with storage, they feature a storage compartment in the central seat cushion, with a handle for easy opening. A second storage compartment is located on the end element.
- Seat cushion zippered (the seat cushion is attached to the frame through a zipper)
- Tight Back Cushion (the back cushions of the models are fixed to the frame)
- No Leather/Fabric Side (the sectional pieces have the side covered with lining and not leather nor fabric)
- Internal wooden frame.
- Packaging: plastic wrap for stationary versions and cardboard box for sofa-bed versions.
- Feet available in wood finishings 09 (Walnut) / 18 (Wengè)
- Feet height 4,0 cm



■ Vers. 129



■ Vers. 129





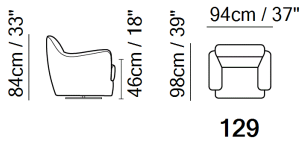

■ Vers. 129

## SCHEMATICS

---



## TECHNICAL INFORMATION

	<b>COVERING</b>	Leather <input checked="" type="checkbox"/>	Soft Cover <input checked="" type="checkbox"/>				
	<b>FILLING</b>	Arms	<input type="checkbox"/> Fiber <input checked="" type="checkbox"/> Foam <input type="checkbox"/> Feather/Fiber Mix <input type="checkbox"/> Feather	Seat cushion	<input type="checkbox"/> Fiber <input checked="" type="checkbox"/> Foam <input type="checkbox"/> Feather/Fiber Mix <input type="checkbox"/> Feather	Back cushion	<input type="checkbox"/> Fiber <input checked="" type="checkbox"/> Foam <input type="checkbox"/> Feather/Fiber Mix <input type="checkbox"/> Feather
	<b>COMFORT</b>	Firm Comfort <input type="checkbox"/>	Standard Comfort <input checked="" type="checkbox"/>				
	<b>FUNCTION</b>	Bed <input type="checkbox"/>	Electric motion <input type="checkbox"/>	Motion <input type="checkbox"/>	Recliner <input type="checkbox"/>	Sliding <input type="checkbox"/>	
	<b>LEGS</b>	Metal <input checked="" type="checkbox"/>	Wood <input type="checkbox"/>	Castors <input type="checkbox"/>	Plastic <input type="checkbox"/>	Upholstered <input type="checkbox"/>	

## NOTES

- Contrast stitching is available only with certain covers and option is managed directly in NARES.
- All arms, back and seat surfaces are covered in Top Grain.
- This model is available with split leather exterior covering (Side, Rear and Front Panels)
- Tight Seat Cushion (the seat cushions of the models are fixed to the frame)
- Tight Back Cushion (the back cushions of the models are fixed to the frame)
- Internal wooden frame.
- With Feet Assembled (the model will be loaded with feet already mounted on the sofa).
- The model will be wrapped in a plastic bag.
- Chair is available with metal swivel base

NOTES

---



■ Vers. N46



■ Vers. N50+N38+076+291+291+049



■ Vers. N54



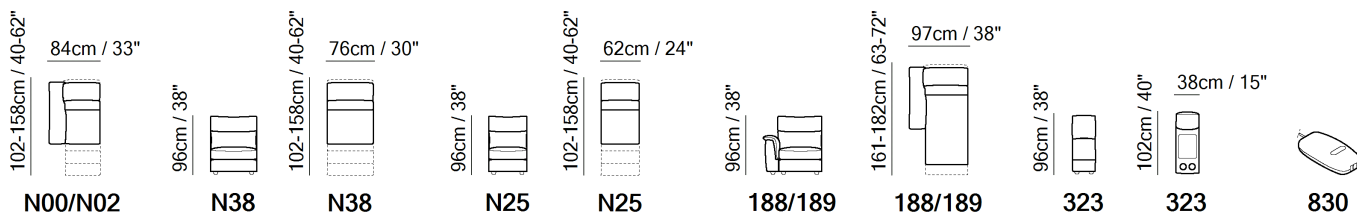
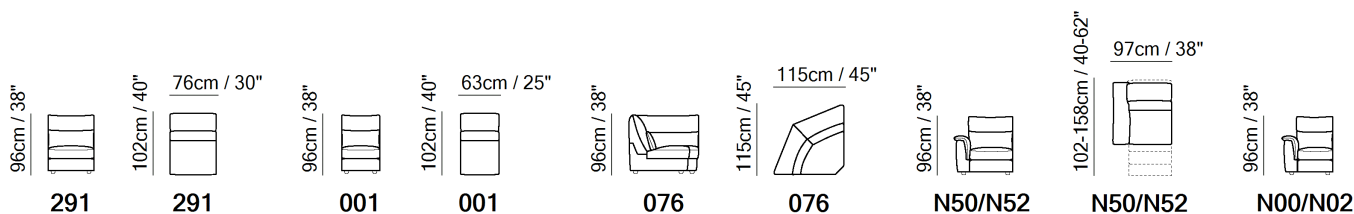
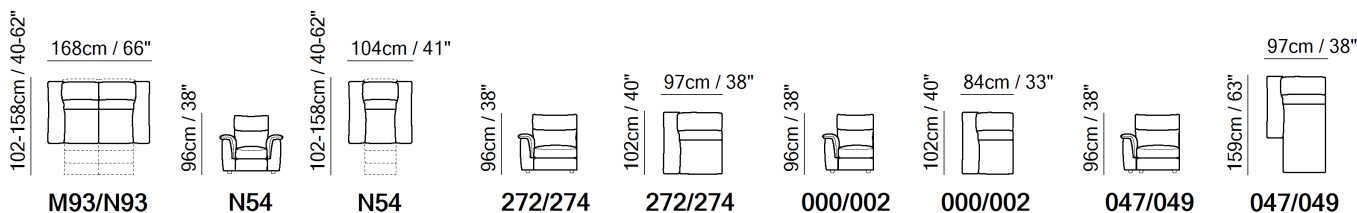
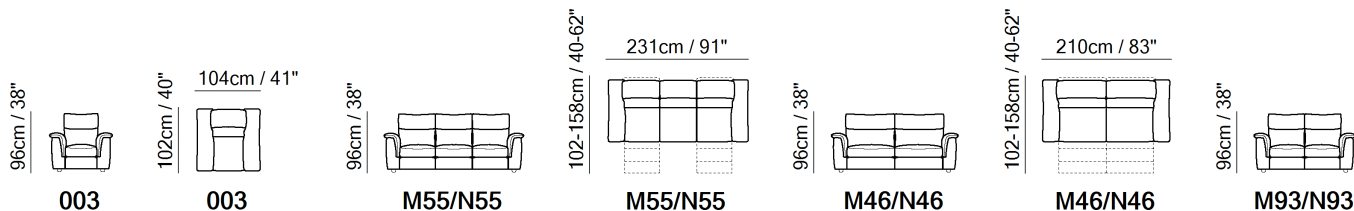
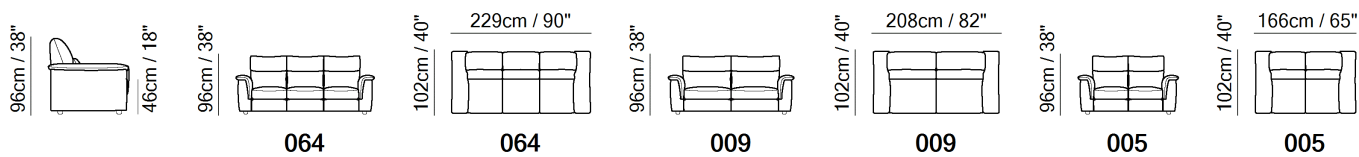

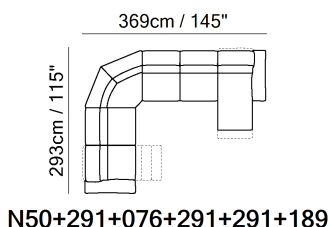

SCHEMATICS



COMPOSITION EXAMPLES



TECHNICAL INFORMATION

	<b>COVERING</b>	Leather <input checked="" type="checkbox"/>	Soft Cover <input checked="" type="checkbox"/>			
	<b>FILLING</b>	Arms <input type="checkbox"/> Fiber <input checked="" type="checkbox"/> Foam <input type="checkbox"/> Feather/Fiber Mix <input type="checkbox"/> Feather	Seat cushion <input type="checkbox"/> Fiber <input checked="" type="checkbox"/> Foam <input type="checkbox"/> Feather/Fiber Mix <input type="checkbox"/> Feather	Back cushion <input type="checkbox"/> Fiber <input checked="" type="checkbox"/> Foam <input type="checkbox"/> Feather/Fiber Mix <input type="checkbox"/> Feather		
	<b>COMFORT</b>	Standard Comfort <input checked="" type="checkbox"/>	Firm Comfort <input checked="" type="checkbox"/>			
	<b>FUNCTION</b>	Bed <input type="checkbox"/>	Electric motion <input checked="" type="checkbox"/>	Motion <input checked="" type="checkbox"/>	Recliner <input checked="" type="checkbox"/>	Sliding <input type="checkbox"/>
	<b>VISUAL APPEARANCE*</b>	Low <input checked="" type="checkbox"/>	Medium <input type="checkbox"/>	High <input type="checkbox"/>		
	<b>LEGS</b>	Wood <input type="checkbox"/>	Metal <input type="checkbox"/>	Upholstered <input type="checkbox"/>	Plastic <input checked="" type="checkbox"/>	Castors <input type="checkbox"/>

VISUAL APPEARANCE

The product may reveal various wrinkles due to the combination of Elasticity of the covering, characteristics of the interior construction and the design of the product.



Products with Visual Appearance listed as High or Medium would require higher degree of care, where seats and back cushions may require fluffing and plumping more often than Products with Visual Appearance listed as Low.

NOTES

- Available in leather (TG only) or fabric.
- CUBICOMFORT™ Triple-Motion Technology is a registered trademark. It denotes a set of independent motion systems that activate the various elements of the sofa (seat, backrest, headrest and footrest) allowing each person to adjust their position of absolute comfort to the millimeter.
- A battery pack can be ordered with its own version code 830. For order entry please use XX for category and XXX for cover code. In order to optimize the duration of the battery, it is suggested to order one per each motion seat.
- All arms, back and seat surfaces are covered in Top Grain.
- This model is available with split leather exterior covering (Side, Rear and Front Panels)
- Tight Seat Cushion (the seat cushions of the models are fixed to the frame)
- Tight Back Cushion (the back cushions of the models are fixed to the frame)
- Internal wooden frame.
- Feet will be in a bag inside the package and requires assembling.
- Packaging: plastic wrap for stationary versions and cardboard box for motion/sofabed versions
- Feet height 4,0 cm

NOTES

---



■ Vers. 009



■ Vers. 400+352+489+001+073



■ Vers. 000+001+049



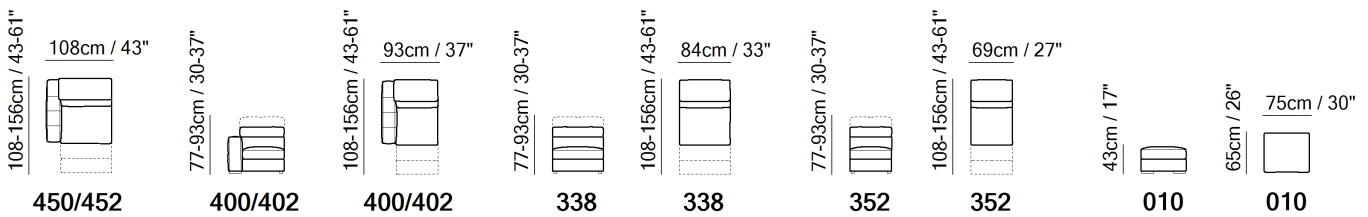
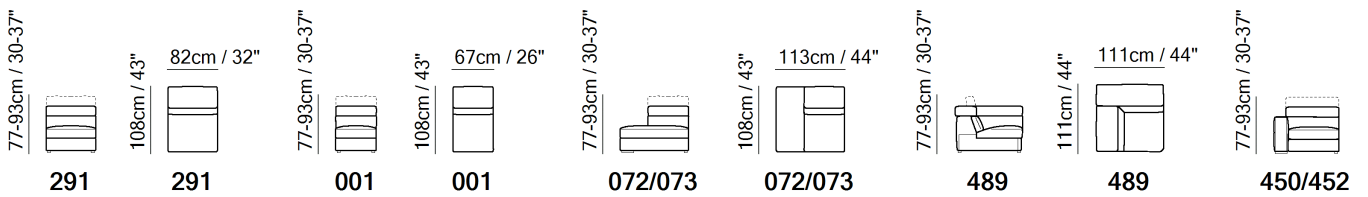
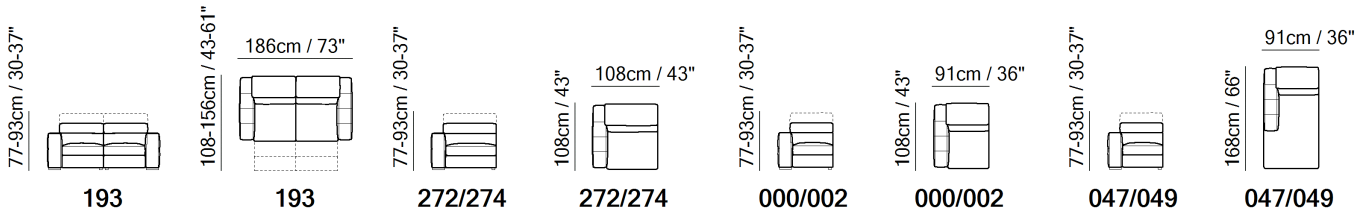
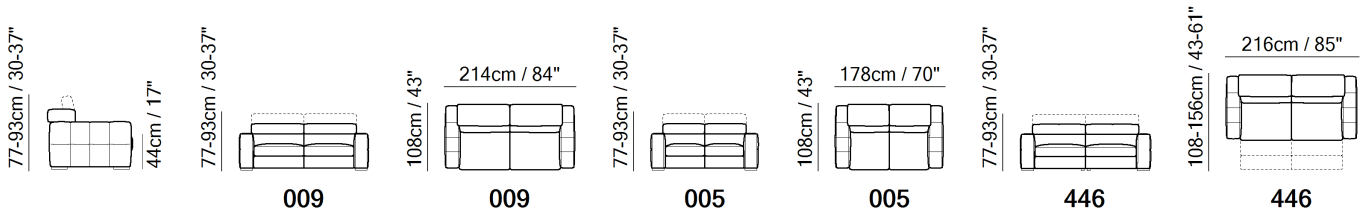

SCHEMATICS

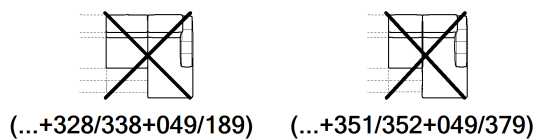
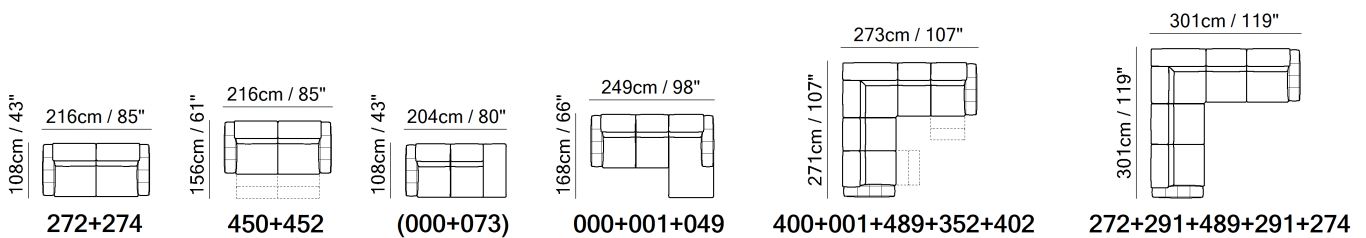

COMPOSITION EXAMPLES



TECHNICAL INFORMATION

	<b>COVERING</b>	Leather <input checked="" type="checkbox"/>	Soft Cover <input checked="" type="checkbox"/>			
	<b>FILLING</b>	Arms <input type="checkbox"/> Fiber <input checked="" type="checkbox"/> Foam <input type="checkbox"/> Feather/Fiber Mix <input type="checkbox"/> Feather	Seat cushion <input type="checkbox"/> Fiber <input checked="" type="checkbox"/> Foam <input type="checkbox"/> Feather/Fiber Mix <input type="checkbox"/> Feather	Back cushion <input type="checkbox"/> Fiber <input checked="" type="checkbox"/> Foam <input type="checkbox"/> Feather/Fiber Mix <input type="checkbox"/> Feather		
	<b>COMFORT</b>	Firm Comfort <input checked="" type="checkbox"/>	Standard Comfort <input checked="" type="checkbox"/>			
	<b>FUNCTION</b>	Bed <input type="checkbox"/>	Electric motion <input checked="" type="checkbox"/>	Motion <input checked="" type="checkbox"/>	Recliner <input type="checkbox"/>	Sliding <input type="checkbox"/>
	<b>LEGS</b>	Metal <input type="checkbox"/>	Wood <input checked="" type="checkbox"/>	Castors <input type="checkbox"/>	Plastic <input type="checkbox"/>	Upholstered <input type="checkbox"/>

NOTES

- LEATHER: Model available only in Top Grain leather
- Power mechanism with switch on the external side panel (power recliner and manual adjustable headrests)
- Tight Seat Cushion (the seat cushions of the models are fixed to the frame)
- Tight Back Cushion (the back cushions of the models are fixed to the frame)
- No Leather/Fabric Side (the sectional pieces have the side covered with lining and not leather nor fabric)
- Internal wooden frame.
- Feet will be in a bag inside the package and requires assembling.
- The model will be wrapped in a plastic bag.
- Feet available in wood finishings 09 (Walnut) / 18 (Wengè)
- Feet height 4,0 cm

**NOTES**

---



■ Vers. 009



■ Vers. 249





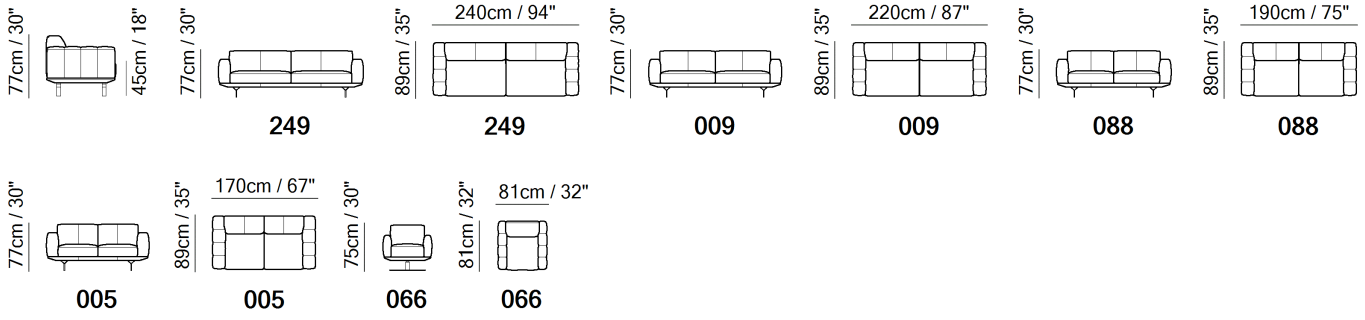

■ Vers. 066

**SCHEMATICS**



TECHNICAL INFORMATION

	<b>COVERING</b>	Leather <input checked="" type="checkbox"/>	Soft Cover <input checked="" type="checkbox"/>				
	<b>FILLING</b>	Arms	<input type="checkbox"/> Fiber <input checked="" type="checkbox"/> Foam <input type="checkbox"/> Feather/Fiber Mix <input type="checkbox"/> Feather	Seat cushion	<input type="checkbox"/> Fiber <input checked="" type="checkbox"/> Foam <input type="checkbox"/> Feather/Fiber Mix <input type="checkbox"/> Feather	Back cushion	<input type="checkbox"/> Fiber <input checked="" type="checkbox"/> Foam <input type="checkbox"/> Feather/Fiber Mix <input type="checkbox"/> Feather
	<b>COMFORT</b>	Standard Comfort <input checked="" type="checkbox"/>	Firm Comfort <input checked="" type="checkbox"/>				
	<b>FUNCTION</b>	Bed <input type="checkbox"/>	Electric motion <input type="checkbox"/>	Motion <input type="checkbox"/>	Recliner <input type="checkbox"/>	Sliding <input type="checkbox"/>	
	<b>LEGS</b>	Wood <input type="checkbox"/> Castors <input type="checkbox"/>	Metal <input checked="" type="checkbox"/>	Metal <input checked="" type="checkbox"/>	Upholstered <input type="checkbox"/>	Plastic <input type="checkbox"/>	

NOTES

- LEATHER: Model available only in Top Grain leather
- Tight Seat Cushion (the seat cushions of the models are fixed to the frame)
- Tight Back Cushion (the back cushions of the models are fixed to the frame)
- Internal wooden frame.
- Feet will be in a bag inside the package and requires assembling.
- The model will be wrapped in a plastic bag.
- Chair (version 066) is available with black mat base only
- Feet available in metal finishing 79 (Matte Black)
- Feet height 17,0 cm

**NOTES**

---



■ Vers. 003



■ Vers. 003







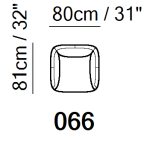
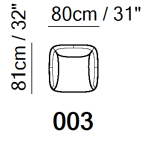
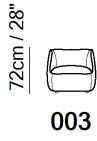
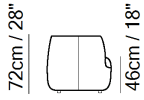

■ Vers. 066

SCHEMATICS

---



TECHNICAL INFORMATION

	<b>COVERING</b>	Leather <input checked="" type="checkbox"/>	Soft Cover <input checked="" type="checkbox"/>				
	<b>FILLING</b>	Arms	<input type="checkbox"/> Fiber <input checked="" type="checkbox"/> Foam <input type="checkbox"/> Feather/Fiber Mix <input type="checkbox"/> Feather	Seat cushion	<input type="checkbox"/> Fiber <input checked="" type="checkbox"/> Foam <input type="checkbox"/> Feather/Fiber Mix <input type="checkbox"/> Feather	Back cushion	<input type="checkbox"/> Fiber <input checked="" type="checkbox"/> Foam <input type="checkbox"/> Feather/Fiber Mix <input type="checkbox"/> Feather
	<b>COMFORT</b>	Firm Comfort <input type="checkbox"/>	Standard Comfort <input checked="" type="checkbox"/>				
	<b>FUNCTION</b>	Bed <input type="checkbox"/>	Electric motion <input type="checkbox"/>	Motion <input type="checkbox"/>	Recliner <input type="checkbox"/>	Sliding <input type="checkbox"/>	
	<b>VISUAL APPEARANCE*</b>	Low <input type="checkbox"/>	Medium <input type="checkbox"/>	High <input checked="" type="checkbox"/>			
	<b>LEGS</b>	Metal <input checked="" type="checkbox"/>	Wood <input type="checkbox"/>	Castors <input type="checkbox"/>	Plastic <input type="checkbox"/>	Upholstered <input type="checkbox"/>	

VISUAL APPEARANCE

The product may reveal various wrinkles due to the combination of Elasticity of the covering, characteristics of the interior construction and the design of the product.



Products with Visual Appearance listed as High or Medium would require higher degree of care, where seats and back cushions may require fluffing and plumping more often than Products with Visual Appearance listed as Low.

NOTES

- Available in leather (TG only) or fabric.
- When the model is in two tones (leather or fabric), 1st and 2nd covering are always the same category.
- Internal wooden frame.
- Feet will be in a bag inside the package and requires assembling.
- Packaging: Cardboard wrap.
- Feet available in metal finishing 79 (Matte Black)

NOTES

---



■ Vers. 003



■ Vers. 003





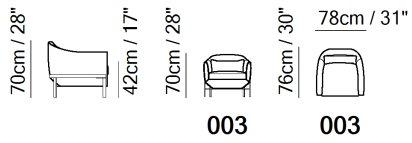

■ Vers. 003

SCHEMATICS

---



**TECHNICAL INFORMATION**

	<b>COVERING</b>	Leather <input checked="" type="checkbox"/>	Soft Cover <input checked="" type="checkbox"/>			
	<b>FILLING</b>	Arms <input type="checkbox"/> Fiber <input checked="" type="checkbox"/> Foam <input type="checkbox"/> Feather/Fiber Mix <input type="checkbox"/> Feather	Seat cushion <input type="checkbox"/> Fiber <input checked="" type="checkbox"/> Foam <input type="checkbox"/> Feather/Fiber Mix <input type="checkbox"/> Feather	Back cushion <input type="checkbox"/> Fiber <input checked="" type="checkbox"/> Foam <input type="checkbox"/> Feather/Fiber Mix <input type="checkbox"/> Feather		
	<b>COMFORT</b>	Standard Comfort <input checked="" type="checkbox"/>	Firm Comfort <input type="checkbox"/>			
	<b>FUNCTION</b>	Bed <input type="checkbox"/>	Electric motion <input type="checkbox"/>	Motion <input type="checkbox"/>	Recliner <input type="checkbox"/>	Sliding <input type="checkbox"/>
	<b>LEGS</b>	Wood <input type="checkbox"/>	Metal <input checked="" type="checkbox"/>	Upholstered <input type="checkbox"/>	Plastic <input type="checkbox"/>	Castors <input type="checkbox"/>

**NOTES**

- Available in leather (TG only) or fabric.
- Internal wooden frame.
- With Feet Assembled (the model will be loaded with feet already mounted on the sofa).
- Packaging: Cardboard wrap.
- Feet available in metal finishing 79 (Matte Black)
- Feet height 14,0 cm

NOTES

---



■ Vers. 009



■ Vers. F46



■ Vers. 272+291+489+291+F52



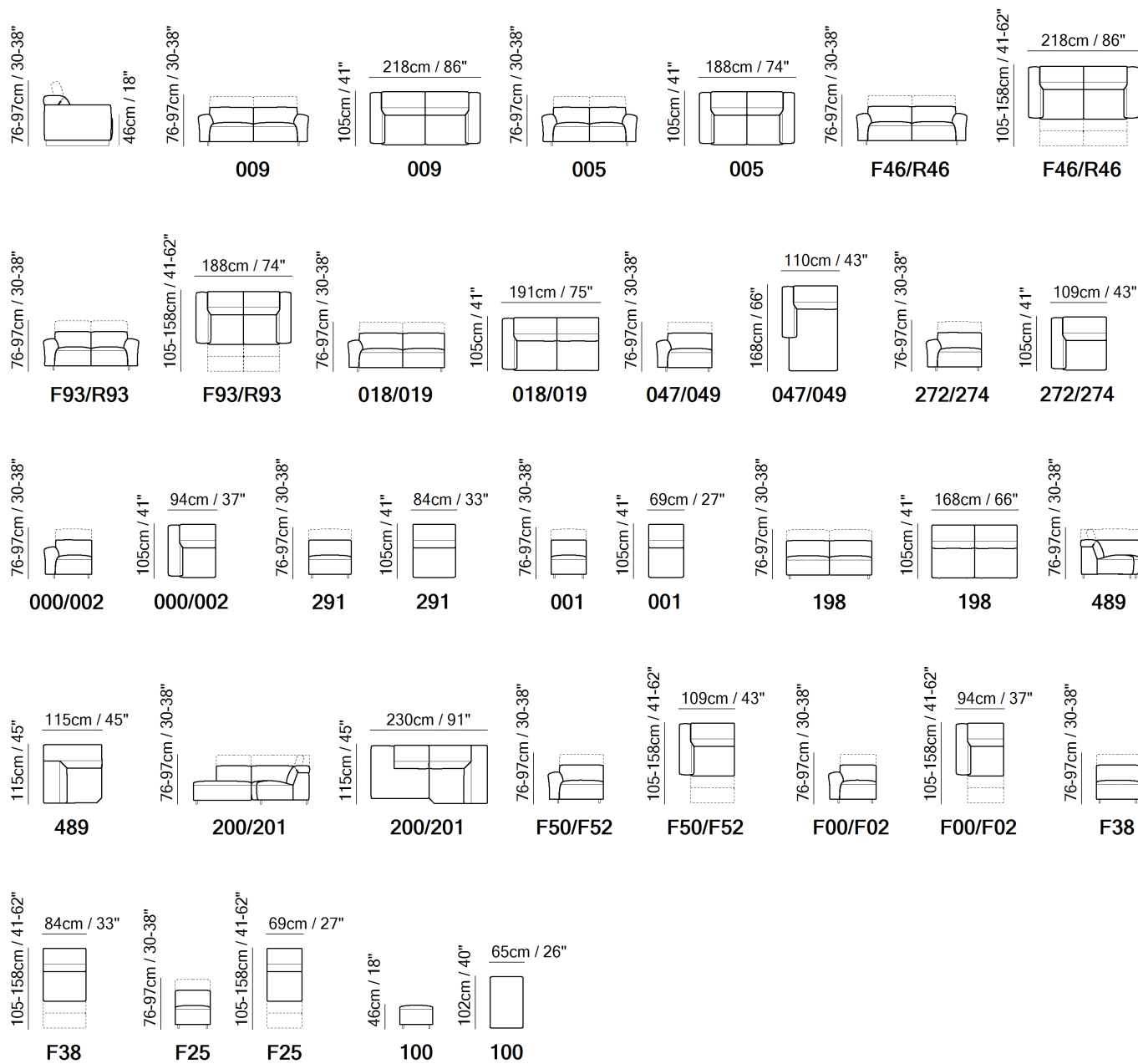

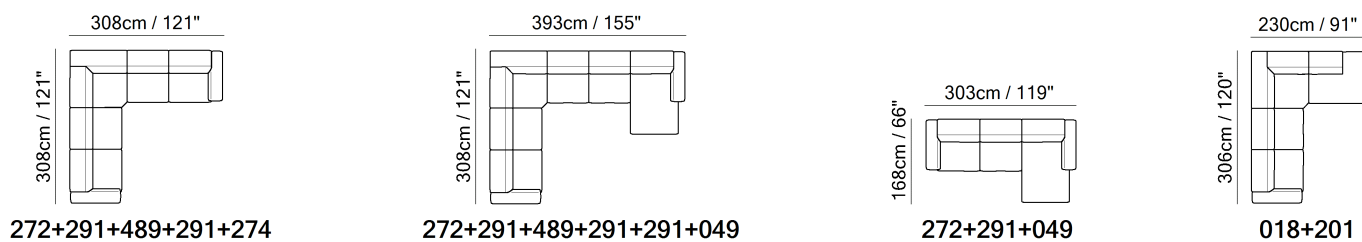

SCHEMATICS



COMPOSITION EXAMPLES



TECHNICAL INFORMATION

	<b>COVERING</b>	Leather <input checked="" type="checkbox"/>	Soft Cover <input checked="" type="checkbox"/>			
	<b>FILLING</b>	Arms	<input type="checkbox"/> Fiber <input checked="" type="checkbox"/> Foam <input type="checkbox"/> Feather/Fiber Mix <input type="checkbox"/> Feather	Seat cushion	<input type="checkbox"/> Fiber <input checked="" type="checkbox"/> Foam <input type="checkbox"/> Feather/Fiber Mix <input type="checkbox"/> Feather	Back cushion <input type="checkbox"/> Fiber <input checked="" type="checkbox"/> Foam <input type="checkbox"/> Feather/Fiber Mix <input type="checkbox"/> Feather
	<b>COMFORT</b>	Firm Comfort <input checked="" type="checkbox"/>	Standard Comfort <input checked="" type="checkbox"/>			
	<b>FUNCTION</b>	Bed <input type="checkbox"/>	Electric motion <input type="checkbox"/>	Motion <input checked="" type="checkbox"/>	Recliner <input checked="" type="checkbox"/>	Sliding <input type="checkbox"/>
	<b>VISUAL APPEARANCE*</b>	Low <input checked="" type="checkbox"/>	Medium <input type="checkbox"/>	High <input type="checkbox"/>		
	<b>LEGS</b>	Metal <input type="checkbox"/>	Wood <input checked="" type="checkbox"/>	Castors <input type="checkbox"/>	Plastic <input type="checkbox"/>	Upholstered <input type="checkbox"/>

VISUAL APPEARANCE

The product may reveal various wrinkles due to the combination of Elasticity of the covering, characteristics of the interior construction and the design of the product.



Products with Visual Appearance listed as High or Medium would require higher degree of care, where seats and back cushions may require fluffing and plumping more often than Products with Visual Appearance listed as Low.

NOTES

- Available in leather (TG only) or fabric.
- Dual power mechanism with power switch on inside panel of the arm that activates recliner and headrest and includes an USB charging port.
- Stationary versions have manually adjustable headrests.
- A battery pack can be ordered with its own version code 830. For order entry please use XX for category and XXX for cover code. In order to optimize the duration of the battery, it is suggested to order one per each motion seat.
- Tight Seat Cushion (the seat cushions of the models are fixed to the frame)
- Tight Back Cushion (the back cushions of the models are fixed to the frame)
- No Leather/Fabric Side (the sectional pieces have the side covered with lining and not leather nor fabric)
- Internal wooden frame.
- Feet will be in a bag inside the package and requires assembling.
- Packaging: plastic wrap for stationary versions and cardboard box for motion/sofabed versions
- Wooden legs available with coffee lacquered 52 or iron grey 53 finishings.
- Feet height 8,0 cm

**NOTES**

---



■ Vers. 064



■ Vers. 239



■ Vers. 200+019



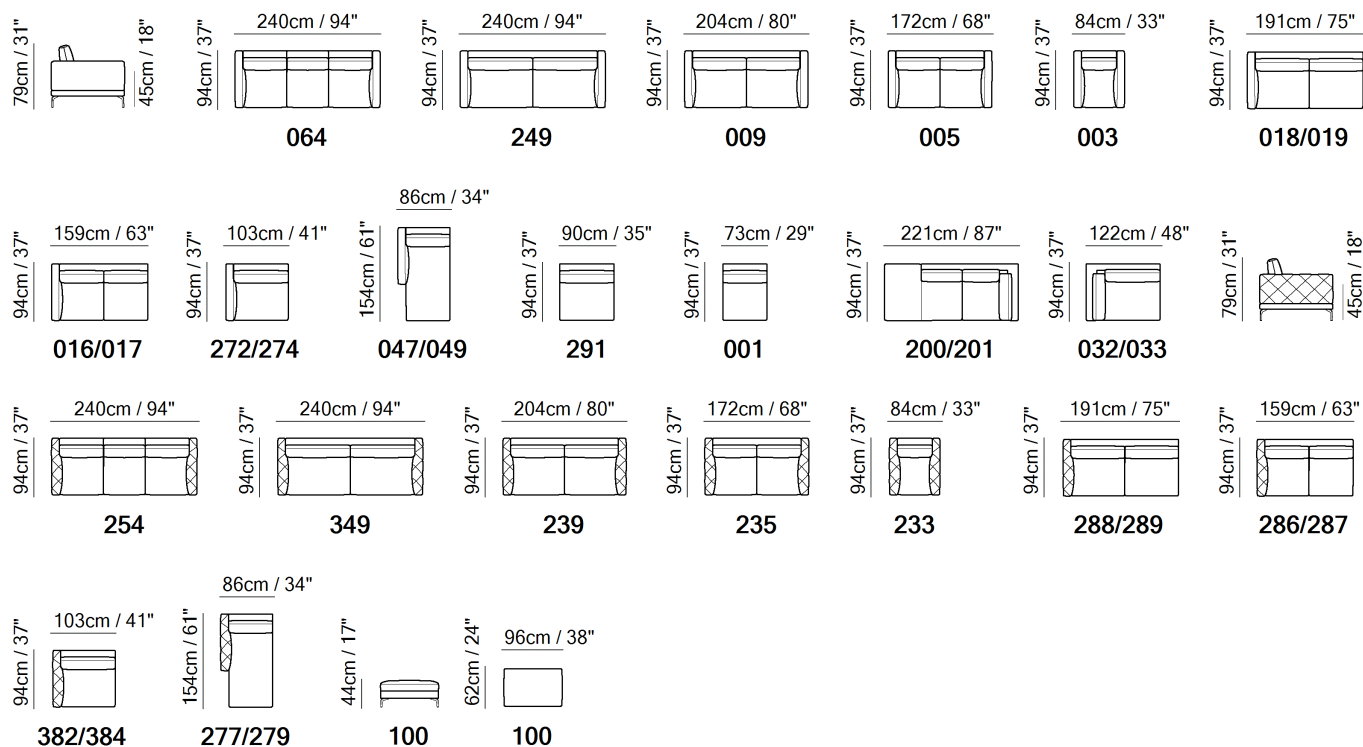

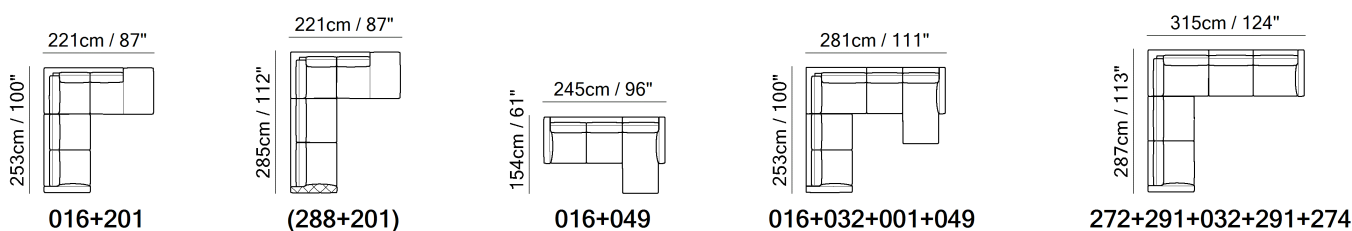

SCHEMATICS



COMPOSITION EXAMPLES



TECHNICAL INFORMATION

	<b>COVERING</b>	Leather <input checked="" type="checkbox"/>	Soft Cover <input checked="" type="checkbox"/>				
	<b>FILLING</b>	Arms	<input type="checkbox"/> Fiber <input checked="" type="checkbox"/> Foam <input type="checkbox"/> Feather/Fiber Mix <input type="checkbox"/> Feather	Seat cushion	<input type="checkbox"/> Fiber <input checked="" type="checkbox"/> Foam <input type="checkbox"/> Feather/Fiber Mix <input type="checkbox"/> Feather	Back cushion	<input type="checkbox"/> Fiber <input checked="" type="checkbox"/> Foam <input type="checkbox"/> Feather/Fiber Mix <input type="checkbox"/> Feather
	<b>COMFORT</b>	Standard Comfort <input checked="" type="checkbox"/>	Firm Comfort <input checked="" type="checkbox"/>				
	<b>FUNCTION</b>	Bed <input type="checkbox"/>	Electric motion <input type="checkbox"/>	Motion <input type="checkbox"/>	Recliner <input type="checkbox"/>	Sliding <input type="checkbox"/>	
	<b>VISUAL APPEARANCE*</b>	Low <input checked="" type="checkbox"/>	Medium <input type="checkbox"/>	High <input type="checkbox"/>			
	<b>LEGS</b>	Wood <input type="checkbox"/>	Metal <input checked="" type="checkbox"/>	Upholstered <input type="checkbox"/>	Plastic <input type="checkbox"/>	Castors <input type="checkbox"/>	

VISUAL APPEARANCE

The product may reveal various wrinkles due to the combination of Elasticity of the covering, characteristics of the interior construction and the design of the product.



Products with Visual Appearance listed as High or Medium would require higher degree of care, where seats and back cushions may require fluffing and plumping more often than Products with Visual Appearance listed as Low.

NOTES

- Available in leather (TG only) or fabric.
- Second option versions of this model are available with quilted arm.
- Tight Seat Cushion (the seat cushions of the models are fixed to the frame)
- Back Cushion Zippered (the back cushion is attached to the frame through a zipper)
- Internal wooden frame.
- Feet will be in a bag inside the package and requires assembling.
- Packaging: Cardboard box. Only ottomans are wrapped in plastic bag.
- Feet available in metal finishing 79 (Matte Black)
- Feet height 15,5 cm

**NOTES**

---



■ Vers. 231



■ Vers. 231





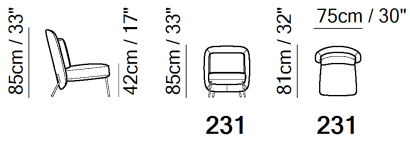

■ Vers. 231

SCHEMATICS

---



TECHNICAL INFORMATION

	<b>COVERING</b>	Leather <input checked="" type="checkbox"/>	Soft Cover <input checked="" type="checkbox"/>				
	<b>FILLING</b>	Arms	<input type="checkbox"/> Fiber <input checked="" type="checkbox"/> Foam <input type="checkbox"/> Feather/Fiber Mix <input type="checkbox"/> Feather	Seat cushion	<input type="checkbox"/> Fiber <input checked="" type="checkbox"/> Foam <input type="checkbox"/> Feather/Fiber Mix <input type="checkbox"/> Feather	Back cushion	<input type="checkbox"/> Fiber <input checked="" type="checkbox"/> Foam <input type="checkbox"/> Feather/Fiber Mix <input type="checkbox"/> Feather
	<b>COMFORT</b>	Firm Comfort <input checked="" type="checkbox"/>	Standard Comfort <input checked="" type="checkbox"/>				
	<b>FUNCTION</b>	Bed <input type="checkbox"/>	Electric motion <input type="checkbox"/>	Motion <input type="checkbox"/>	Recliner <input type="checkbox"/>	Sliding <input type="checkbox"/>	
	<b>LEGS</b>	Metal <input checked="" type="checkbox"/>	Wood <input type="checkbox"/>	Castors <input type="checkbox"/>	Plastic <input type="checkbox"/>	Upholstered <input type="checkbox"/>	

NOTES

- Tight Seat Cushion (the seat cushions of the models are fixed to the frame)
- Tight Back Cushion (the back cushions of the models are fixed to the frame)
- Internal wooden frame.
- Feet will be in a bag inside the package and requires assembling.
- The model will be wrapped in a plastic bag.
- Feet height 26,0 cm

NOTES

---



■ Vers. 009



■ Vers. F50+F38+011+019



■ Vers. 003



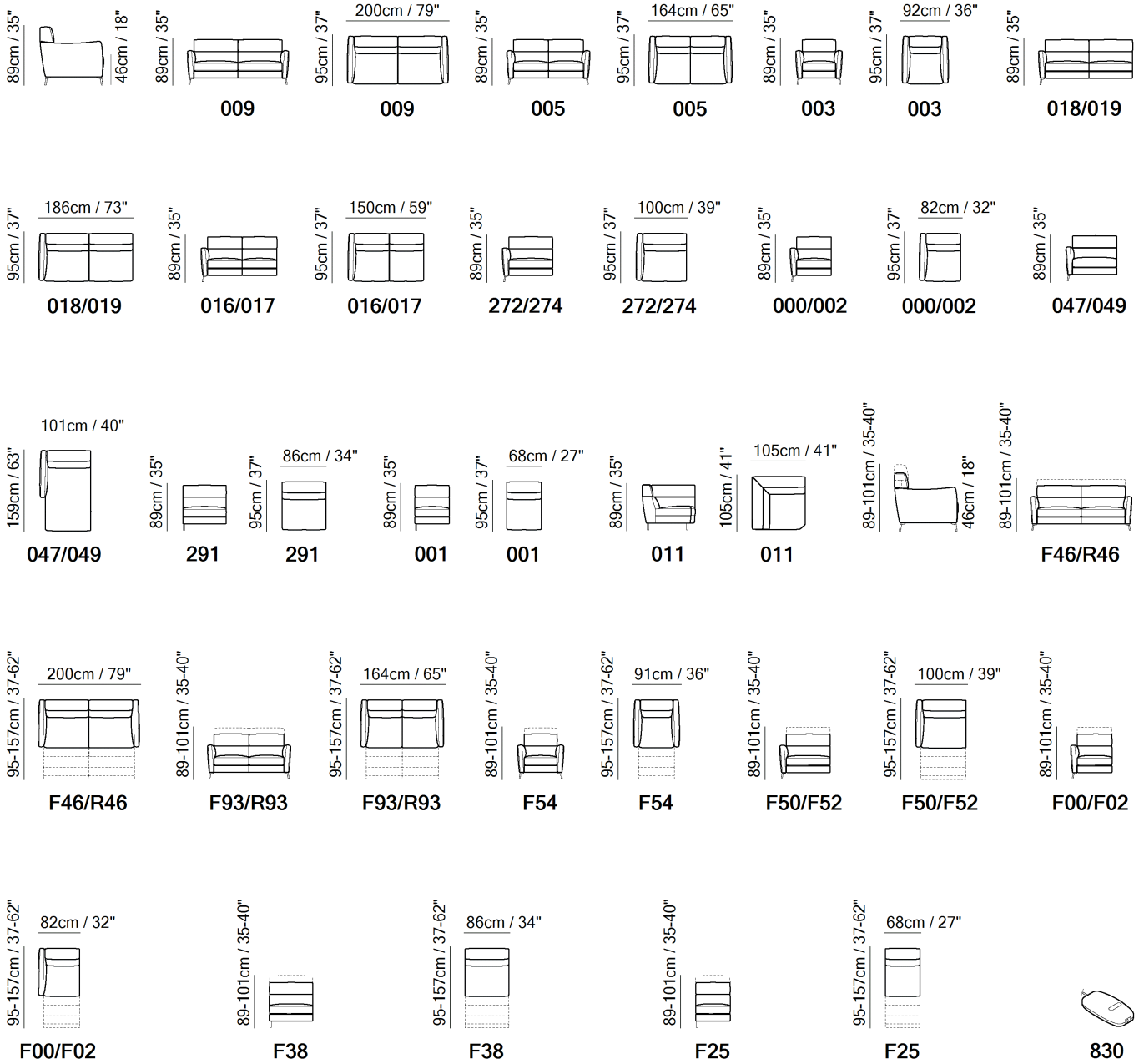

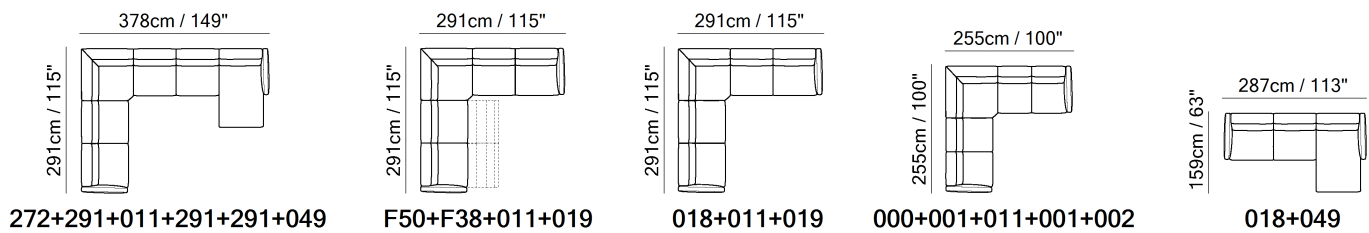

SCHEMATICS



COMPOSITION EXAMPLES



TECHNICAL INFORMATION

	<b>COVERING</b>	Leather <input checked="" type="checkbox"/>	Soft Cover <input checked="" type="checkbox"/>				
	<b>FILLING</b>	Arms	<input type="checkbox"/> Fiber <input checked="" type="checkbox"/> Foam <input type="checkbox"/> Feather/Fiber Mix <input type="checkbox"/> Feather	Seat cushion	<input type="checkbox"/> Fiber <input checked="" type="checkbox"/> Foam <input type="checkbox"/> Feather/Fiber Mix <input type="checkbox"/> Feather	Back cushion	<input type="checkbox"/> Fiber <input checked="" type="checkbox"/> Foam <input type="checkbox"/> Feather/Fiber Mix <input type="checkbox"/> Feather
	<b>COMFORT</b>	Standard Comfort <input checked="" type="checkbox"/>	Firm Comfort <input checked="" type="checkbox"/>				
	<b>FUNCTION</b>	Bed <input type="checkbox"/>	Electric motion <input type="checkbox"/>	Motion <input checked="" type="checkbox"/>	Recliner <input checked="" type="checkbox"/>	Sliding <input type="checkbox"/>	
	<b>VISUAL APPEARANCE*</b>	Low <input checked="" type="checkbox"/>	Medium <input type="checkbox"/>	High <input type="checkbox"/>			
	<b>LEGS</b>	Wood <input type="checkbox"/>	Metal <input checked="" type="checkbox"/>	Upholstered <input type="checkbox"/>	Plastic <input type="checkbox"/>	Castors <input type="checkbox"/>	

VISUAL APPEARANCE

The product may reveal various wrinkles due to the combination of Elasticity of the covering, characteristics of the interior construction and the design of the product.



Products with Visual Appearance listed as High or Medium would require higher degree of care, where seats and back cushions may require fluffing and plumping more often than Products with Visual Appearance listed as Low.

NOTES

- Available in leather (TG only) or fabric.
- Dual power mechanism with external switch on the side panel that activates recliner and power headrest lift with manual adjustable tilt position and includes an USB charging port.
- A battery pack can be ordered with its own version code 830. For order entry please use XX for category and XXX for cover code. In order to optimize the duration of the battery, it is suggested to order one per each motion seat.
- Tight Seat Cushion (the seat cushions of the models are fixed to the frame)
- Tight Back Cushion (the back cushions of the models are fixed to the frame)
- Internal wooden frame.
- Feet will be in a bag inside the package and requires assembling.
- Packaging: Cardboard wrap.
- Metal legs available with matt black (79) or metal gold (90) finishings
- Feet height 13,0 cm

NOTES

---



■ Vers. 480+F83



■ Vers. 480+F83



■ Vers. 480+F83



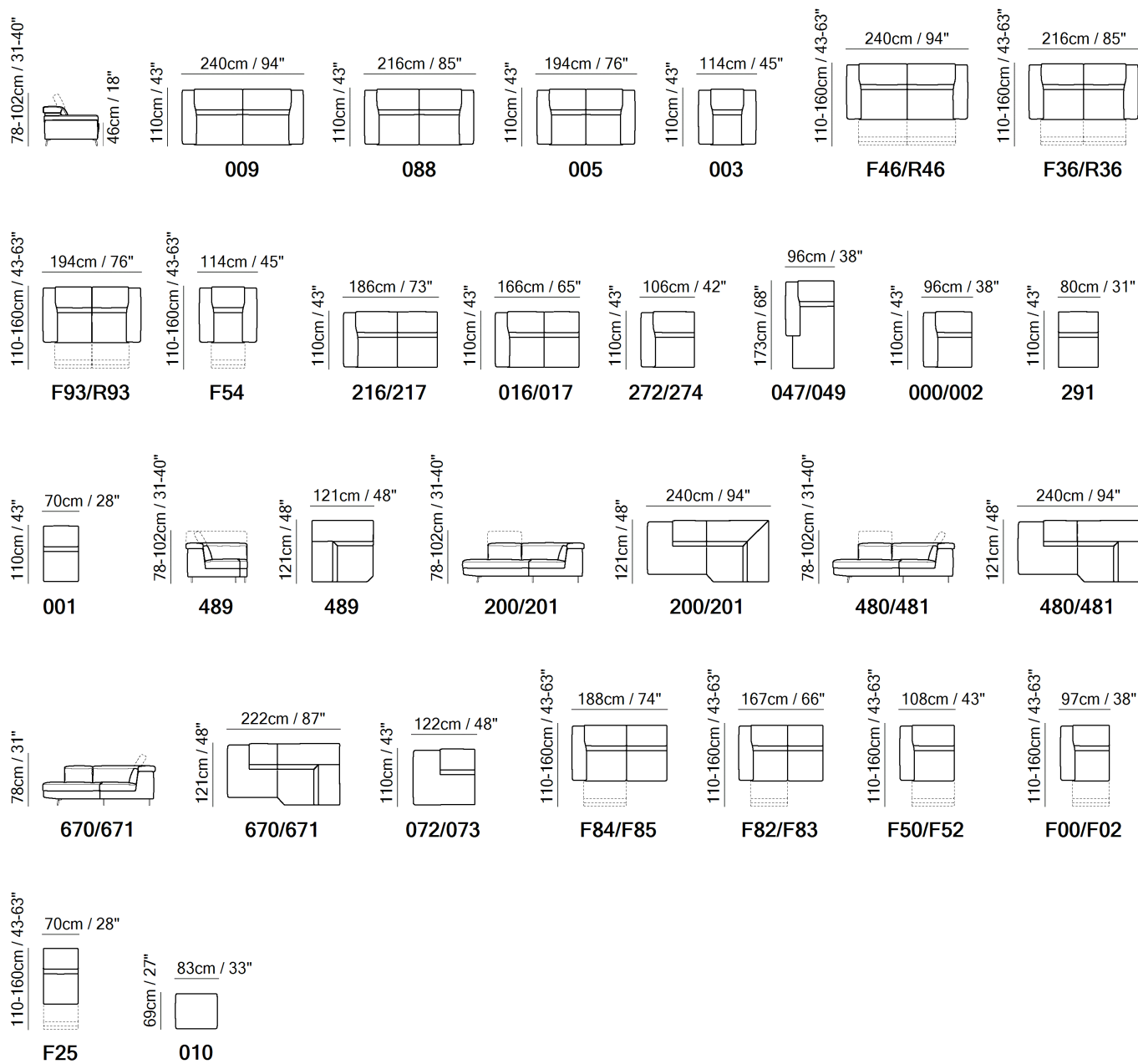

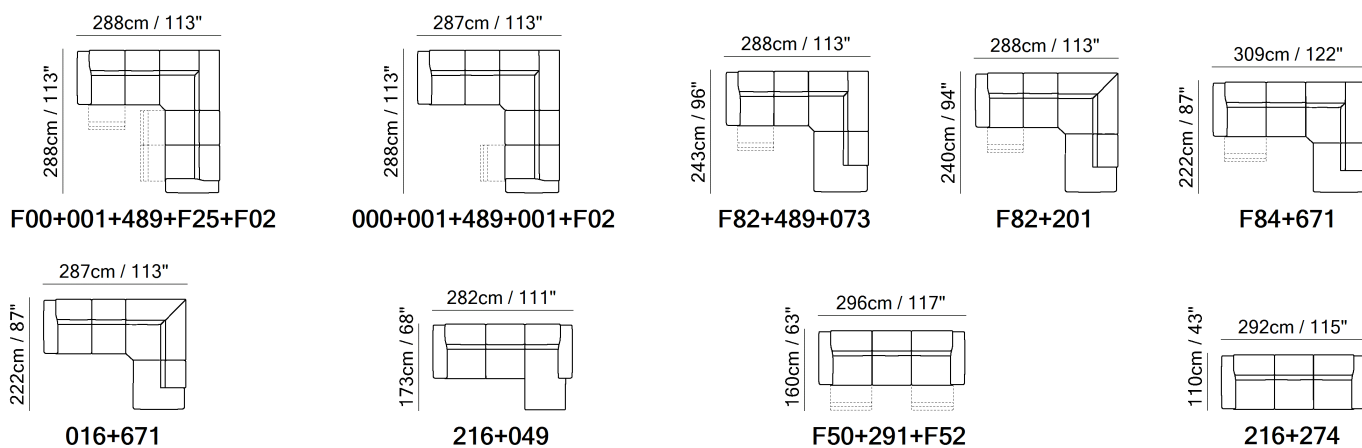

SCHEMATICS



COMPOSITION EXAMPLES



TECHNICAL INFORMATION

	<b>COVERING</b>	Leather <input checked="" type="checkbox"/>	Soft Cover <input checked="" type="checkbox"/>			
	<b>FILLING</b>	Arms <input type="checkbox"/> Fiber <input checked="" type="checkbox"/> Foam <input type="checkbox"/> Feather/Fiber Mix <input type="checkbox"/> Feather	Seat cushion <input type="checkbox"/> Fiber <input checked="" type="checkbox"/> Foam <input type="checkbox"/> Feather/Fiber Mix <input type="checkbox"/> Feather	Back cushion <input type="checkbox"/> Fiber <input checked="" type="checkbox"/> Foam <input type="checkbox"/> Feather/Fiber Mix <input type="checkbox"/> Feather		
	<b>COMFORT</b>	Firm Comfort <input checked="" type="checkbox"/>	Standard Comfort <input checked="" type="checkbox"/>			
	<b>FUNCTION</b>	Bed <input type="checkbox"/>	Electric motion <input type="checkbox"/>	Motion <input checked="" type="checkbox"/>	Recliner <input checked="" type="checkbox"/>	Sliding <input type="checkbox"/>
	<b>VISUAL APPEARANCE*</b>	Low <input checked="" type="checkbox"/>	Medium <input type="checkbox"/>	High <input type="checkbox"/>		
	<b>LEGS</b>	Metal <input checked="" type="checkbox"/>	Wood <input type="checkbox"/>	Castors <input type="checkbox"/>	Plastic <input type="checkbox"/>	Upholstered <input type="checkbox"/>

VISUAL APPEARANCE

The product may reveal various wrinkles due to the combination of Elasticity of the covering, characteristics of the interior construction and the design of the product.



Products with Visual Appearance listed as High or Medium would require higher degree of care, where seats and back cushions may require fluffing and plumping more often than Products with Visual Appearance listed as Low.

NOTES

- Available in leather (TG only) or fabric.
- Dual power mechanism with external switch on the side panel that activates recliner and headrest and includes an USB charging port
- A battery pack can be ordered with its own version code 830. For order entry please use XX for category and XXX for cover code. In order to optimize the duration of the battery, it is suggested to order one per each motion seat.
- Tight Seat Cushion (the seat cushions of the models are fixed to the frame)
- Tight Back Cushion (the back cushions of the models are fixed to the frame)
- No Leather/Fabric Side (the sectional pieces have the side covered with lining and not leather nor fabric)
- Internal wooden frame.
- Feet will be in a bag inside the package and requires assembling.
- Packaging: plastic wrap for stationary versions and cardboard box for motion/sofabed versions
- Metal legs available with matt black (79) or metal gold (90) finishings
- Feet height 12,5 cm

NOTES

---



■ Vers. 003



■ Vers. 003



■ Vers. 003

SCHEMATICS

---

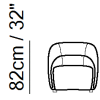
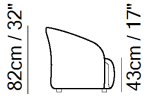

003

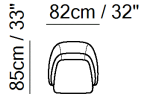

003

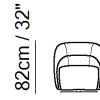



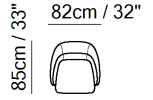



066



066

TECHNICAL INFORMATION

	<b>COVERING</b>	Leather <input checked="" type="checkbox"/>	Soft Cover <input checked="" type="checkbox"/>				
	<b>FILLING</b>	Arms	<input type="checkbox"/> Fiber <input checked="" type="checkbox"/> Foam <input type="checkbox"/> Feather/Fiber Mix <input type="checkbox"/> Feather	Seat cushion	<input type="checkbox"/> Fiber <input checked="" type="checkbox"/> Foam <input type="checkbox"/> Feather/Fiber Mix <input type="checkbox"/> Feather	Back cushion	<input type="checkbox"/> Fiber <input checked="" type="checkbox"/> Foam <input type="checkbox"/> Feather/Fiber Mix <input type="checkbox"/> Feather
	<b>COMFORT</b>	Standard Comfort <input checked="" type="checkbox"/>	Firm Comfort <input type="checkbox"/>				
	<b>FUNCTION</b>	Bed <input type="checkbox"/>	Electric motion <input type="checkbox"/>	Motion <input type="checkbox"/>	Recliner <input type="checkbox"/>	Sliding <input type="checkbox"/>	
	<b>VISUAL APPEARANCE*</b>	Low <input checked="" type="checkbox"/>	Medium <input type="checkbox"/>	High <input type="checkbox"/>			
	<b>LEGS</b>	Wood <input type="checkbox"/>	Metal <input type="checkbox"/>	Upholstered <input type="checkbox"/>	Plastic <input checked="" type="checkbox"/>	Castors <input type="checkbox"/>	

VISUAL APPEARANCE

The product may reveal various wrinkles due to the combination of Elasticity of the covering, characteristics of the interior construction and the design of the product.



Products with Visual Appearance listed as High or Medium would require higher degree of care, where seats and back cushions may require fluffing and plumping more often than Products with Visual Appearance listed as Low.

NOTES

- Available in leather (TG only) or fabric.
- Occasional chair available with swivel function (vers. 066) or stationary (vers. 003 or 233)
- Tight Seat Cushion (the seat cushions of the models are fixed to the frame)
- Tight Back Cushion (the back cushions of the models are fixed to the frame)
- Internal wooden frame.
- Feet will be in a bag inside the package and requires assembling.
- The model will be wrapped in a plastic bag.
- Feet height 4,0 cm

NOTES

---



■ Vers. 233



■ Vers. 233



■ Vers. 066

SCHEMATICS

---

74cm / 29"  
  
42cm / 17"

74cm / 29"  
  
**233**







83cm / 33"    79cm / 31"  
  
**233**

74cm / 29"  
  
**066**

74cm / 29"  
  
**066**

83cm / 33"    79cm / 31"  
  
**066**

TECHNICAL INFORMATION

	<b>COVERING</b>	Leather <input checked="" type="checkbox"/>	Soft Cover <input checked="" type="checkbox"/>				
	<b>FILLING</b>	Arms	<input type="checkbox"/> Fiber <input checked="" type="checkbox"/> Foam <input type="checkbox"/> Feather/Fiber Mix <input type="checkbox"/> Feather	Seat cushion	<input type="checkbox"/> Fiber <input checked="" type="checkbox"/> Foam <input type="checkbox"/> Feather/Fiber Mix <input type="checkbox"/> Feather	Back cushion	<input type="checkbox"/> Fiber <input checked="" type="checkbox"/> Foam <input type="checkbox"/> Feather/Fiber Mix <input type="checkbox"/> Feather
	<b>COMFORT</b>	Firm Comfort <input type="checkbox"/>	Standard Comfort <input checked="" type="checkbox"/>				
	<b>FUNCTION</b>	Bed <input type="checkbox"/>	Electric motion <input type="checkbox"/>	Motion <input type="checkbox"/>	Recliner <input type="checkbox"/>	Sliding <input type="checkbox"/>	
	<b>VISUAL APPEARANCE*</b>	Low <input checked="" type="checkbox"/>	Medium <input type="checkbox"/>	High <input type="checkbox"/>			
	<b>LEGS</b>	Wood <input type="checkbox"/>	Metal <input checked="" type="checkbox"/>	Castors <input type="checkbox"/>	Plastic <input type="checkbox"/>	Upholstered <input type="checkbox"/>	

VISUAL APPEARANCE

The product may reveal various wrinkles due to the combination of Elasticity of the covering, characteristics of the interior construction and the design of the product.



Products with Visual Appearance listed as High or Medium would require higher degree of care, where seats and back cushions may require fluffing and plumping more often than Products with Visual Appearance listed as Low.

NOTES

- Available in leather (TG only) or fabric.
- Model is available with contrast welt (or any another decorative detail such as a band under arm cushion) to be entered as second covering in the same category.
- FABRIC: In fabric contrast welt (as well as any another decorative detail such as a band under arm cushion or backrest or inserts) can be made with any color of art. Le Mans.
- Occasional chair available with swivel function (vers. 066) or stationary (vers. 003 or 233)
- Tight Seat Cushion (the seat cushions of the models are fixed to the frame)
- Tight Back Cushion (the back cushions of the models are fixed to the frame)
- Internal wooden frame.
- Feet will be in a bag inside the package and requires assembling.
- Packaging: Cardboard wrap.
- Front feet are slightly higher in respect to rear.
- Feet available in metal finishing 79 (Matte Black)
- Feet height 17,3 - 14,3 cm

**NOTES**

---



■ Vers. F44



■ Vers. F44



■ Vers. F45

SCHEMATICS



F45

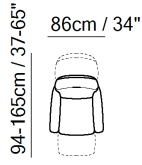

F45



F44

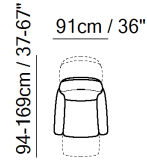







F44



830

TECHNICAL INFORMATION

	<b>COVERING</b>	Leather <input checked="" type="checkbox"/>	Soft Cover <input checked="" type="checkbox"/>			
	<b>FILLING</b>	Arms <input type="checkbox"/> Fiber <input checked="" type="checkbox"/> Foam <input type="checkbox"/> Feather/Fiber Mix <input type="checkbox"/> Feather	Seat cushion <input type="checkbox"/> Fiber <input checked="" type="checkbox"/> Foam <input type="checkbox"/> Feather/Fiber Mix <input type="checkbox"/> Feather	Back cushion <input type="checkbox"/> Fiber <input checked="" type="checkbox"/> Foam <input type="checkbox"/> Feather/Fiber Mix <input type="checkbox"/> Feather		
	<b>COMFORT</b>	Standard Comfort <input checked="" type="checkbox"/>	Firm Comfort <input type="checkbox"/>			
	<b>FUNCTION</b>	Bed <input type="checkbox"/>	Electric motion <input type="checkbox"/>	Motion <input type="checkbox"/>	Recliner <input type="checkbox"/>	Sliding <input type="checkbox"/>
	<b>VISUAL APPEARANCE*</b>	Low <input checked="" type="checkbox"/>	Medium <input type="checkbox"/>	High <input type="checkbox"/>		
	<b>LEGS</b>	Wood <input type="checkbox"/>	Metal <input checked="" type="checkbox"/>	Upholstered <input type="checkbox"/>	Plastic <input type="checkbox"/>	Castors <input type="checkbox"/>

VISUAL APPEARANCE

The product may reveal various wrinkles due to the combination of Elasticity of the covering, characteristics of the interior construction and the design of the product.



Products with Visual Appearance listed as High or Medium would require higher degree of care, where seats and back cushions may require fluffing and plumping more often than Products with Visual Appearance listed as Low.

NOTES

- Available in leather (TG only) or fabric.
- Ergocert Certified. Human-Centered Design certification by Ergocert, is the first European ergonomics certification body. This certification guarantees that the entire design and production process has been completed by listening to the needs of the end user to create and offer an effective and unique comfort experience.
- Available in two different sizes: King size (version F44) and Queen size (F45). Compared to the queen version, the king version is taller and wider.
- The model has external switch on the side panel to activate the mechanism.
- A battery pack can be ordered with its own version code 830. For order entry please use XX for category and XXX for cover code. In order to optimize the duration of the battery, it is suggested to order one per each motion seat.
- Internal wooden frame.
- Packaging: Cardboard wrap.
- Base available in metal plate one finishing only (chromed).

NOTES

---



■ Vers. 272+291+011+291+221



■ Vers. 220+291+100+291+274



■ Vers. 272+291+221



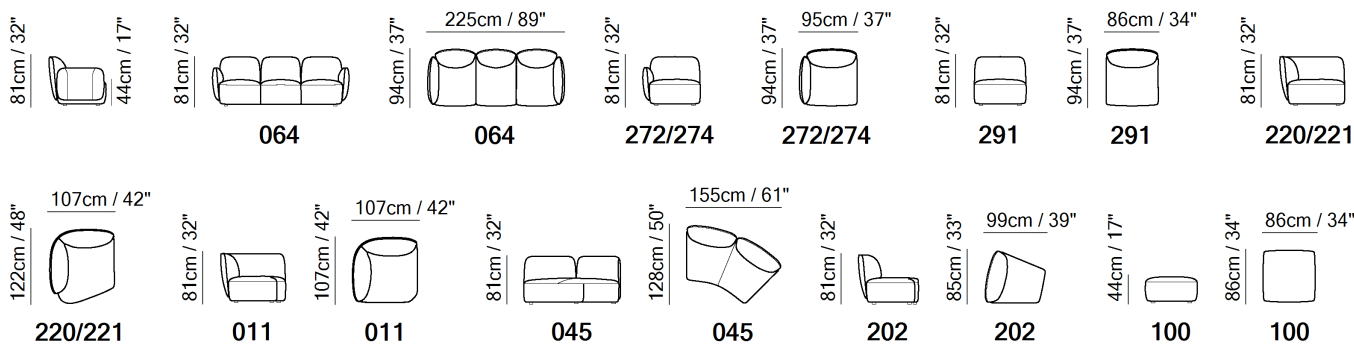

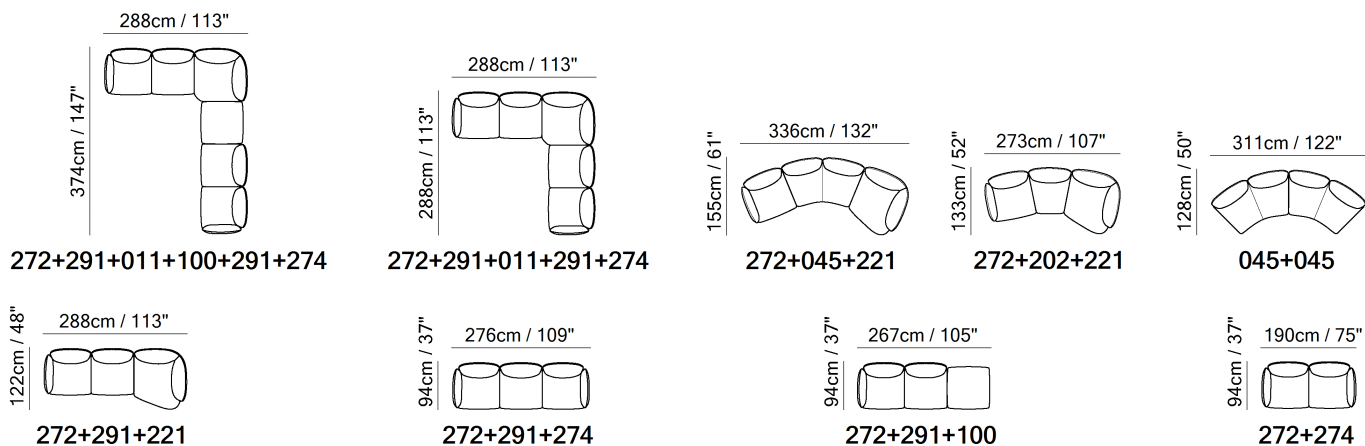

SCHEMATICS



COMPOSITION EXAMPLES



TECHNICAL INFORMATION

	<b>COVERING</b>	Leather <input checked="" type="checkbox"/>	Soft Cover <input checked="" type="checkbox"/>			
	<b>FILLING</b>	Arms <input type="checkbox"/> Fiber <input checked="" type="checkbox"/> Foam <input type="checkbox"/> Feather/Fiber Mix <input type="checkbox"/> Feather	Seat cushion <input type="checkbox"/> Fiber <input checked="" type="checkbox"/> Foam <input type="checkbox"/> Feather/Fiber Mix <input type="checkbox"/> Feather	Back cushion <input type="checkbox"/> Fiber <input checked="" type="checkbox"/> Foam <input type="checkbox"/> Feather/Fiber Mix <input type="checkbox"/> Feather		
	<b>COMFORT</b>	Firm Comfort <input checked="" type="checkbox"/>	Standard Comfort <input checked="" type="checkbox"/>			
	<b>FUNCTION</b>	Bed <input type="checkbox"/>	Electric motion <input type="checkbox"/>	Motion <input type="checkbox"/>	Recliner <input type="checkbox"/>	Sliding <input type="checkbox"/>
	<b>VISUAL APPEARANCE*</b>	Low <input type="checkbox"/>	Medium <input checked="" type="checkbox"/>	High <input type="checkbox"/>		
	<b>LEGS</b>	Wood <input type="checkbox"/>	Metal <input type="checkbox"/>	Castors <input type="checkbox"/>	Plastic <input checked="" type="checkbox"/>	Upholstered <input type="checkbox"/>

VISUAL APPEARANCE

The product may reveal various wrinkles due to the combination of Elasticity of the covering, characteristics of the interior construction and the design of the product.



Products with Visual Appearance listed as High or Medium would require higher degree of care, where seats and back cushions may require fluffing and plumping more often than Products with Visual Appearance listed as Low.

NOTES

- Available in leather (TG only) or fabric.
- Tight Seat Cushion (the seat cushions of the models are fixed to the frame)
- Tight Back Cushion (the back cushions of the models are fixed to the frame)
- All versions are finished on the sides and come without connectors to be used as single elements.
- Internal wooden frame.
- Feet will be in a bag inside the package and requires assembling.
- Packaging: Cardboard wrap.
- Feet height 3,0 cm

NOTES

---



■ Vers. F44



■ Vers. F44



■ Vers. F45

SCHEMATICS



F44

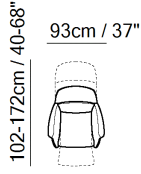

F44



F45

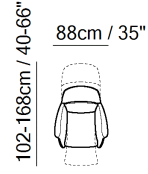







F45



830

TECHNICAL INFORMATION

	<b>COVERING</b>	Leather <input checked="" type="checkbox"/>	Soft Cover <input checked="" type="checkbox"/>			
	<b>FILLING</b>	Arms <input type="checkbox"/> Fiber <input checked="" type="checkbox"/> Foam <input type="checkbox"/> Feather/Fiber Mix <input type="checkbox"/> Feather	Seat cushion <input type="checkbox"/> Fiber <input checked="" type="checkbox"/> Foam <input type="checkbox"/> Feather/Fiber Mix <input type="checkbox"/> Feather	Back cushion <input type="checkbox"/> Fiber <input checked="" type="checkbox"/> Foam <input type="checkbox"/> Feather/Fiber Mix <input type="checkbox"/> Feather		
	<b>COMFORT</b>	Standard Comfort <input checked="" type="checkbox"/>	Firm Comfort <input type="checkbox"/>			
	<b>FUNCTION</b>	Bed <input type="checkbox"/>	Electric motion <input type="checkbox"/>	Motion <input type="checkbox"/>	Recliner <input type="checkbox"/>	Sliding <input type="checkbox"/>
	<b>VISUAL APPEARANCE*</b>	Low <input checked="" type="checkbox"/>	Medium <input type="checkbox"/>	High <input type="checkbox"/>		
	<b>LEGS</b>	Wood <input type="checkbox"/>	Metal <input checked="" type="checkbox"/>	Upholstered <input type="checkbox"/>	Plastic <input type="checkbox"/>	Castors <input type="checkbox"/>

VISUAL APPEARANCE

The product may reveal various wrinkles due to the combination of Elasticity of the covering, characteristics of the interior construction and the design of the product.



Products with Visual Appearance listed as High or Medium would require higher degree of care, where seats and back cushions may require fluffing and plumping more often than Products with Visual Appearance listed as Low.

NOTES

- Available in leather (TG only) or fabric.
- Ergocert Certified. Human-Centered Design certification by Ergocert, is the first European ergonomics certification body. This certification guarantees that the entire design and production process has been completed by listening to the needs of the end user to create and offer an effective and unique comfort experience.
- Available in two different sizes: King size (version F44) and Queen size (F45). Compared to the queen version, the king version is taller and wider.
- A battery pack can be ordered with its own version code 830. For order entry please use XX for category and XXX for cover code. In order to optimize the duration of the battery, it is suggested to order one per each motion seat.
- Wood/Metal Frame
- Packaging: Cardboard wrap.
- Metal base in one finishing (anthracite)

NOTES

---



■ Vers. F44



■ Vers. F44







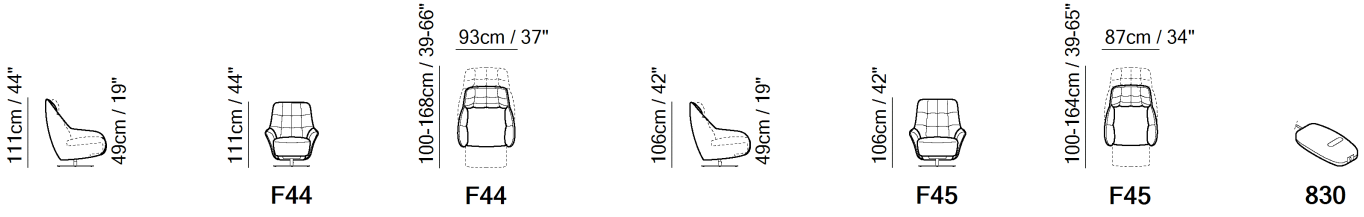

■ Vers. F45

SCHEMATICS



TECHNICAL INFORMATION

	<b>COVERING</b>	Leather <input checked="" type="checkbox"/>	Soft Cover <input checked="" type="checkbox"/>			
	<b>FILLING</b>	Arms <input type="checkbox"/> Fiber <input checked="" type="checkbox"/> Foam <input type="checkbox"/> Feather/Fiber Mix <input type="checkbox"/> Feather	Seat cushion <input type="checkbox"/> Fiber <input checked="" type="checkbox"/> Foam <input type="checkbox"/> Feather/Fiber Mix <input type="checkbox"/> Feather	Back cushion <input type="checkbox"/> Fiber <input checked="" type="checkbox"/> Foam <input type="checkbox"/> Feather/Fiber Mix <input type="checkbox"/> Feather		
	<b>COMFORT</b>	Firm Comfort <input type="checkbox"/>	Standard Comfort <input checked="" type="checkbox"/>			
	<b>FUNCTION</b>	Bed <input type="checkbox"/>	Electric motion <input type="checkbox"/>	Motion <input type="checkbox"/>	Recliner <input type="checkbox"/>	Sliding <input type="checkbox"/>
	<b>VISUAL APPEARANCE*</b>	Low <input type="checkbox"/>	Medium <input checked="" type="checkbox"/>	High <input type="checkbox"/>		
	<b>LEGS</b>	Wood <input type="checkbox"/>	Metal <input checked="" type="checkbox"/>	Castors <input type="checkbox"/>	Plastic <input type="checkbox"/>	Upholstered <input type="checkbox"/>

VISUAL APPEARANCE

The product may reveal various wrinkles due to the combination of Elasticity of the covering, characteristics of the interior construction and the design of the product.



Products with Visual Appearance listed as High or Medium would require higher degree of care, where seats and back cushions may require fluffing and plumping more often than Products with Visual Appearance listed as Low.

NOTES

- Available in leather (TG only) or fabric.
- Ergocert Certified. Human-Centered Design certification by Ergocert, is the first European ergonomics certification body. This certification guarantees that the entire design and production process has been completed by listening to the needs of the end user to create and offer an effective and unique comfort experience.
- Available in two different sizes: King size (version F44) and Queen size (F45). Compared to the queen version, the king version is taller and wider.
- A battery pack can be ordered with its own version code 830. For order entry please use XX for category and XXX for cover code. In order to optimize the duration of the battery, it is suggested to order one per each motion seat.
- Smart touch buttons to activate power reclining functions positioned on the side of the seating
- The Home button is available on the switch that close the footrest and it is identified with a black triangle symbol.
- While in seating position: buttons on the right side activate the recliner/footrest and buttons on the left side activate the backrest.
- Packaging: Cardboard wrap.
- Metal plate in one finishing only (matte black).
- Feet height 10,0 cm

NOTES

---



■ Vers. 066



■ Vers. 066



■ Vers. 066



SCHEMATICS

---



003

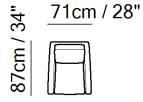

003

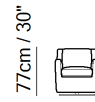



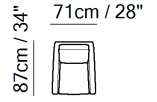



066



066

TECHNICAL INFORMATION

	<b>COVERING</b>	Leather <input checked="" type="checkbox"/>	Soft Cover <input checked="" type="checkbox"/>				
	<b>FILLING</b>	Arms	<input type="checkbox"/> Fiber <input checked="" type="checkbox"/> Foam <input type="checkbox"/> Feather/Fiber Mix <input type="checkbox"/> Feather	Seat cushion	<input type="checkbox"/> Fiber <input checked="" type="checkbox"/> Foam <input type="checkbox"/> Feather/Fiber Mix <input type="checkbox"/> Feather	Back cushion	<input type="checkbox"/> Fiber <input checked="" type="checkbox"/> Foam <input type="checkbox"/> Feather/Fiber Mix <input type="checkbox"/> Feather
	<b>COMFORT</b>	Standard Comfort <input checked="" type="checkbox"/>	Firm Comfort <input type="checkbox"/>				
	<b>FUNCTION</b>	Bed <input type="checkbox"/>	Electric motion <input type="checkbox"/>	Motion <input type="checkbox"/>	Recliner <input type="checkbox"/>	Sliding <input type="checkbox"/>	
	<b>VISUAL APPEARANCE*</b>	Low <input checked="" type="checkbox"/>	Medium <input type="checkbox"/>	High <input type="checkbox"/>			
	<b>LEGS</b>	Wood <input checked="" type="checkbox"/>	Metal <input checked="" type="checkbox"/>	Upholstered <input type="checkbox"/>	Plastic <input type="checkbox"/>	Castors <input type="checkbox"/>	

VISUAL APPEARANCE

The product may reveal various wrinkles due to the combination of Elasticity of the covering, characteristics of the interior construction and the design of the product.



Products with Visual Appearance listed as High or Medium would require higher degree of care, where seats and back cushions may require fluffing and plumping more often than Products with Visual Appearance listed as Low.

NOTES

- Available in leather (TG only) or fabric.
- Occasional chair available with swivel function (vers. 066) or stationary (vers. 003 or 233)
- Packaging: Cardboard wrap.
- Chair (version 066) is available with metal plate.
- Feet available in wood finishings 09 (Walnut) / 18 (Wengè)

NOTES

---



■ Vers. 031+127



■ Vers. 031+127







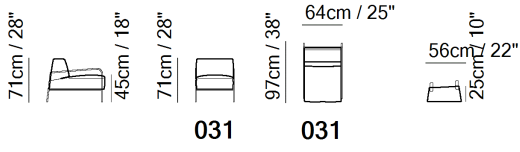

■ Vers. 031+127

SCHEMATICS

---



TECHNICAL INFORMATION

	<b>COVERING</b>	Mix <input checked="" type="checkbox"/>	Leather <input checked="" type="checkbox"/>	Soft Cover <input checked="" type="checkbox"/>		
	<b>FILLING</b>	Arms	<input type="checkbox"/> Fiber <input checked="" type="checkbox"/> Foam <input type="checkbox"/> Feather/Fiber Mix <input type="checkbox"/> Feather	Seat cushion	<input type="checkbox"/> Fiber <input checked="" type="checkbox"/> Foam <input type="checkbox"/> Feather/Fiber Mix <input type="checkbox"/> Feather	Back cushion <input type="checkbox"/> Fiber <input checked="" type="checkbox"/> Foam <input type="checkbox"/> Feather/Fiber Mix <input type="checkbox"/> Feather
	<b>COMFORT</b>	Firm Comfort <input type="checkbox"/>	Standard Comfort <input checked="" type="checkbox"/>			
	<b>FUNCTION</b>	Bed <input type="checkbox"/>	Electric motion <input type="checkbox"/>	Motion <input type="checkbox"/>	Recliner <input type="checkbox"/>	Sliding <input type="checkbox"/>
	<b>VISUAL APPEARANCE*</b>	Low <input checked="" type="checkbox"/>	Medium <input type="checkbox"/>	High <input type="checkbox"/>		
	<b>LEGS</b>	Wood <input type="checkbox"/>	Metal <input checked="" type="checkbox"/>	Castors <input type="checkbox"/>	Plastic <input type="checkbox"/>	Upholstered <input type="checkbox"/>

VISUAL APPEARANCE

The product may reveal various wrinkles due to the combination of Elasticity of the covering, characteristics of the interior construction and the design of the product.



Products with Visual Appearance listed as High or Medium would require higher degree of care, where seats and back cushions may require fluffing and plumping more often than Products with Visual Appearance listed as Low.

NOTES

- Available in leather (TG only) or fabric.
- Leather/Fabric MIX CATEGORIES are based on the STARTING PRICE CATEGORY OF LEATHER combined with fabric = 1B (cat. 15 + fabric) - 2A (cat. 20 ...) - 2B (cat. 25 ...) - 3A (cat. 30 ...)
- Optional side bags to be ordered with version 127 in both leather or fabric.
- Packaging: Cardboard wrap.
- Metal base available in finishing 79 (Matte Black)
- When in mix to be ordered in 2 coverings  
1st covering: leather (side)  
2nd covering: fabric (seat and back cushions)

NOTES

---



■ Vers. 009



■ Vers. 018+827+110



■ Vers. 072+033+019



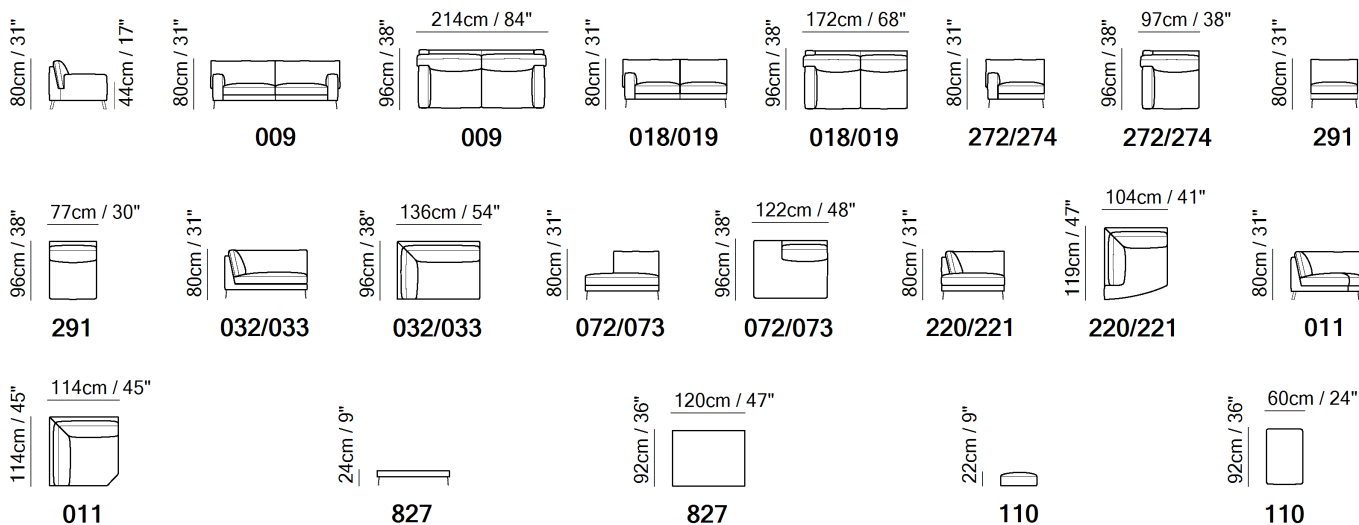

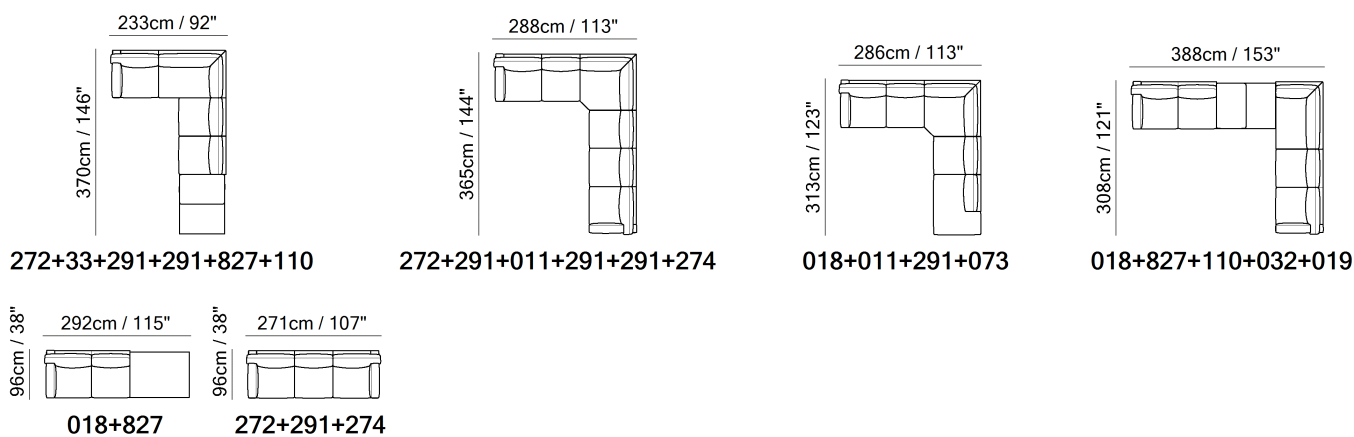

SCHEMATICS



COMPOSITION EXAMPLES



TECHNICAL INFORMATION

	<b>COVERING</b>	Leather <input checked="" type="checkbox"/>	Soft Cover <input checked="" type="checkbox"/>				
	<b>FILLING</b>	Arms	<input type="checkbox"/> Fiber <input checked="" type="checkbox"/> Foam <input type="checkbox"/> Feather/Fiber Mix <input type="checkbox"/> Feather	Seat cushion	<input type="checkbox"/> Fiber <input checked="" type="checkbox"/> Foam <input type="checkbox"/> Feather/Fiber Mix <input type="checkbox"/> Feather	Back cushion	<input type="checkbox"/> Fiber <input checked="" type="checkbox"/> Foam <input type="checkbox"/> Feather/Fiber Mix <input type="checkbox"/> Feather
	<b>COMFORT</b>	Standard Comfort <input checked="" type="checkbox"/>	Firm Comfort <input checked="" type="checkbox"/>				
	<b>FUNCTION</b>	Bed <input type="checkbox"/>	Electric motion <input type="checkbox"/>	Motion <input type="checkbox"/>	Recliner <input type="checkbox"/>	Sliding <input type="checkbox"/>	
	<b>VISUAL APPEARANCE*</b>	Low <input checked="" type="checkbox"/>	Medium <input type="checkbox"/>	High <input type="checkbox"/>			
	<b>LEGS</b>	Wood <input type="checkbox"/>	Metal <input checked="" type="checkbox"/>	Upholstered <input type="checkbox"/>	Plastic <input type="checkbox"/>	Castors <input type="checkbox"/>	

VISUAL APPEARANCE

The product may reveal various wrinkles due to the combination of Elasticity of the covering, characteristics of the interior construction and the design of the product.



Products with Visual Appearance listed as High or Medium would require higher degree of care, where seats and back cushions may require fluffing and plumping more often than Products with Visual Appearance listed as Low.

NOTES

- Available in leather (TG only) or fabric.
- All versions are finished on the sides and come without connectors to be used as single elements.
- Version 827: Finishing table top finishing in Tobacco Tanganyika
- Regarding the order entry of vers. 827, use XX for category and the XXX for cover code.
- Packaging: Cardboard wrap.
- Feet available in metal finishing 79 (Matte Black)

NOTES

---



■ Vers. 064



■ Vers. 003







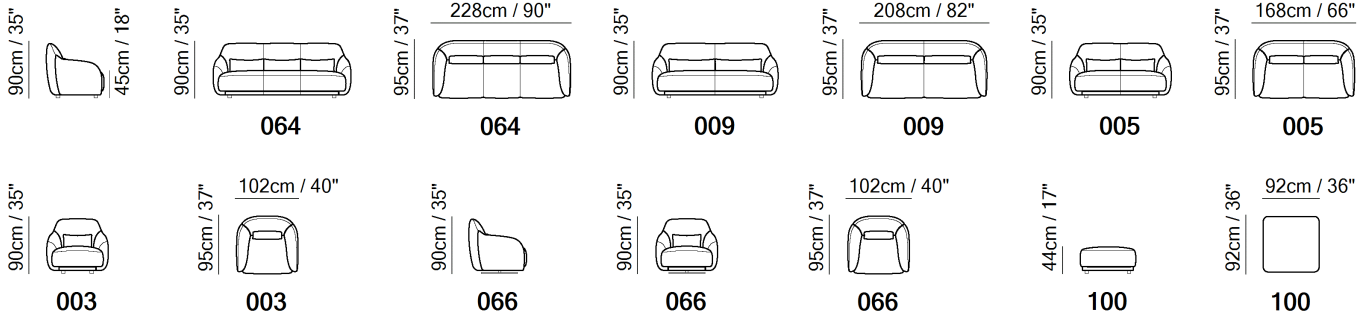

■ Vers. 100

SCHEMATICS



TECHNICAL INFORMATION

	<b>COVERING</b>	Soft Cover <input checked="" type="checkbox"/>	Mix <input checked="" type="checkbox"/>	Leather <input checked="" type="checkbox"/>		
	<b>FILLING</b>	Arms <input type="checkbox"/> Fiber <input checked="" type="checkbox"/> Foam <input type="checkbox"/> Feather/Fiber Mix <input type="checkbox"/> Feather	Seat cushion <input type="checkbox"/> Fiber <input checked="" type="checkbox"/> Foam <input type="checkbox"/> Feather/Fiber Mix <input type="checkbox"/> Feather	Back cushion <input type="checkbox"/> Fiber <input checked="" type="checkbox"/> Foam <input type="checkbox"/> Feather/Fiber Mix <input type="checkbox"/> Feather		
	<b>COMFORT</b>	Firm Comfort <input checked="" type="checkbox"/>	Standard Comfort <input checked="" type="checkbox"/>			
	<b>FUNCTION</b>	Bed <input type="checkbox"/>	Electric motion <input type="checkbox"/>	Motion <input type="checkbox"/>	Recliner <input type="checkbox"/>	Sliding <input type="checkbox"/>
	<b>VISUAL APPEARANCE*</b>	Low <input checked="" type="checkbox"/>	Medium <input type="checkbox"/>	High <input type="checkbox"/>		
	<b>LEGS</b>	Metal <input type="checkbox"/>	Wood <input type="checkbox"/>	Upholstered <input type="checkbox"/>	Castors <input type="checkbox"/>	Plastic <input checked="" type="checkbox"/>

VISUAL APPEARANCE

The product may reveal various wrinkles due to the combination of Elasticity of the covering, characteristics of the interior construction and the design of the product.



Products with Visual Appearance listed as High or Medium would require higher degree of care, where seats and back cushions may require fluffing and plumping more often than Products with Visual Appearance listed as Low.

NOTES

- Available in leather (TG only), fabric and mix
- Leather/Fabric MIX CATEGORIES are based on the STARTING PRICE CATEGORY OF LEATHER combined with fabric = 1B (cat. 15 + fabric) - 2A (cat. 20 ...) - 2B (cat. 25 ...) - 3A (cat. 30 ...)
- Packaging: Cardboard wrap.
- LEATHER-FABRIC MIX:
- 1° Cov. (Leather): outside body
- 2° Cov. (Fabric): seat, lumbar and back cushion in fabric

NOTES

---



■ Vers. 009



■ Vers. 847+389



■ Vers. 389



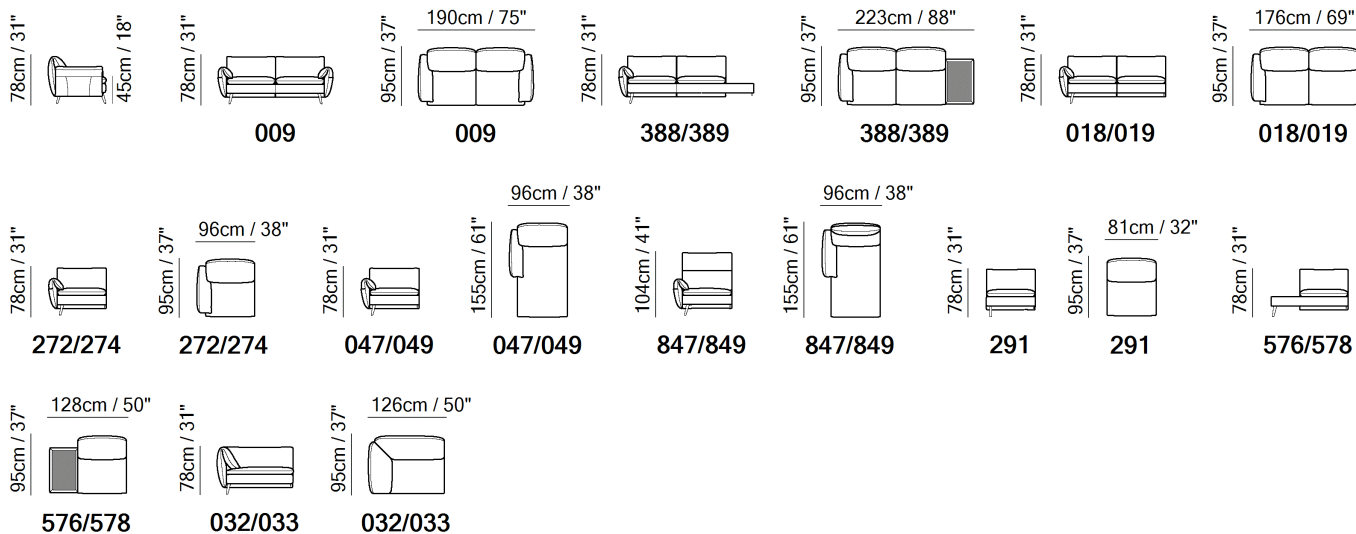

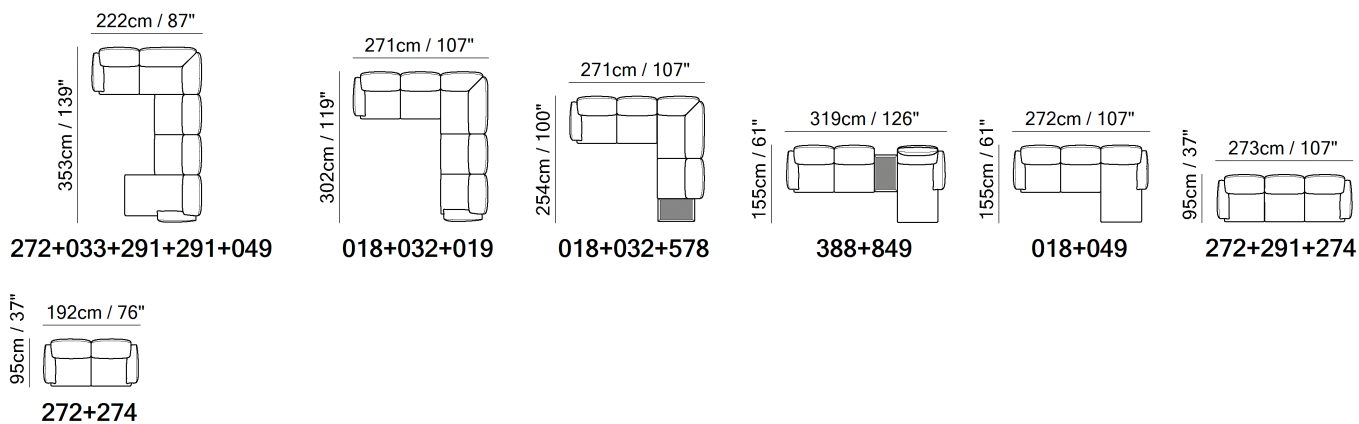

SCHEMATICS



COMPOSITION EXAMPLES



TECHNICAL INFORMATION

	<b>COVERING</b>	Leather <input checked="" type="checkbox"/>	Soft Cover <input checked="" type="checkbox"/>				
	<b>FILLING</b>	Arms	<input type="checkbox"/> Fiber <input checked="" type="checkbox"/> Foam <input type="checkbox"/> Feather/Fiber Mix <input type="checkbox"/> Feather	Seat cushion	<input type="checkbox"/> Fiber <input checked="" type="checkbox"/> Foam <input type="checkbox"/> Feather/Fiber Mix <input type="checkbox"/> Feather	Back cushion	<input type="checkbox"/> Fiber <input checked="" type="checkbox"/> Foam <input type="checkbox"/> Feather/Fiber Mix <input type="checkbox"/> Feather
	<b>COMFORT</b>	Standard Comfort <input checked="" type="checkbox"/>	Firm Comfort <input checked="" type="checkbox"/>				
	<b>FUNCTION</b>	Bed <input type="checkbox"/>	Electric motion <input type="checkbox"/>	Motion <input type="checkbox"/>	Recliner <input type="checkbox"/>	Sliding <input type="checkbox"/>	
	<b>VISUAL APPEARANCE*</b>	Low <input type="checkbox"/>	Medium <input checked="" type="checkbox"/>	High <input type="checkbox"/>			
	<b>LEGS</b>	Wood <input type="checkbox"/>	Metal <input checked="" type="checkbox"/>	Upholstered <input type="checkbox"/>	Plastic <input type="checkbox"/>	Castors <input type="checkbox"/>	

VISUAL APPEARANCE

The product may reveal various wrinkles due to the combination of Elasticity of the covering, characteristics of the interior construction and the design of the product.



Products with Visual Appearance listed as High or Medium would require higher degree of care, where seats and back cushions may require fluffing and plumping more often than Products with Visual Appearance listed as Low.

NOTES

- Available in leather (TG only) or fabric.
- Versions 388/389 (3 seater sofa with one arm left/right and table top on the opposite side) include a wooden side table in ash brown finishing only.
- The versions 388/389 - 047/049 and 847-849 can be displayed as a “stand-alone” element or “connecting” version. For this reason they are provided with both:
  - aesthetic legs (to be used when the versions live as stand-alone)
  - connecting legs (to be used when these versions are connected with other versions).
- The chaise longue version of the model is available with low back (standard version 047/049) or with high back (new versions 847/849). It’s strongly recommended to display the high back chaise longue together with versions 388/389.
- Packaging: Cardboard wrap.
- Feet available in metal finishing 79 (Matte Black)

NOTES

---



■ Vers. F50+291+F52



■ Vers. F50+291+F52



■ Vers. 272+011+291+323+F52



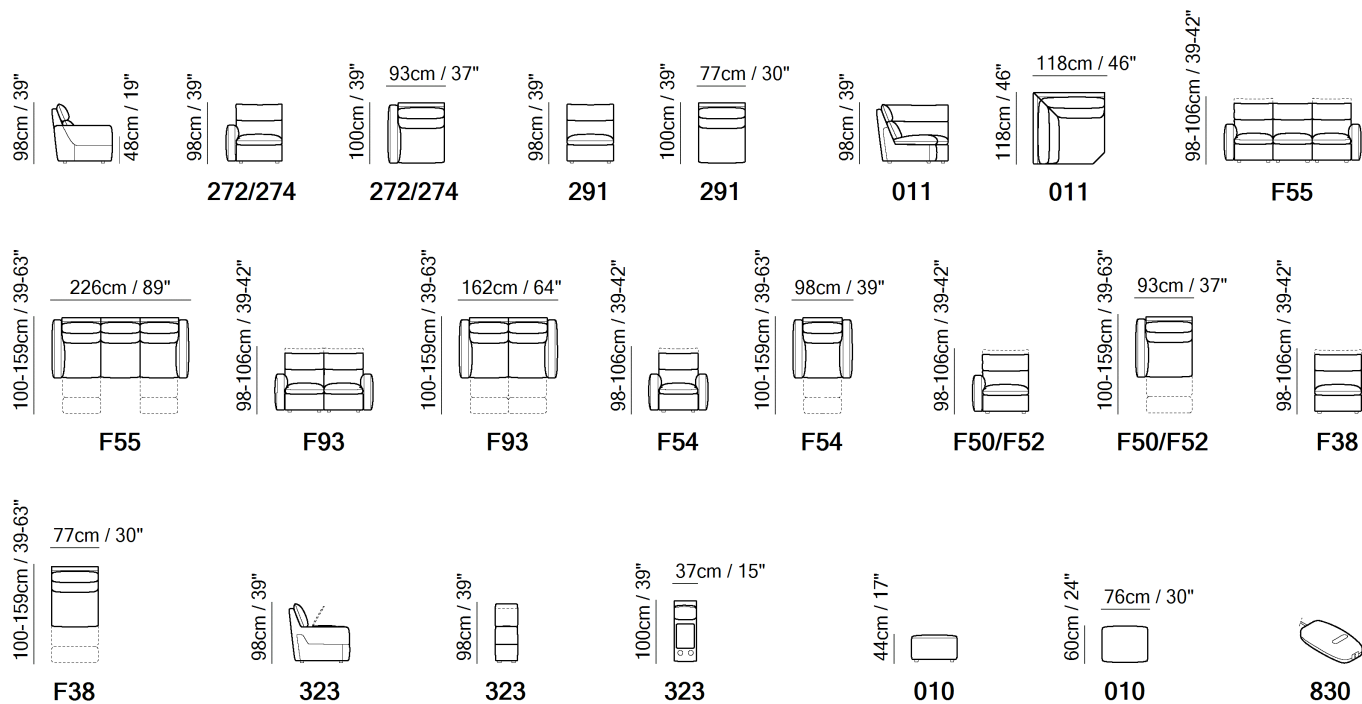

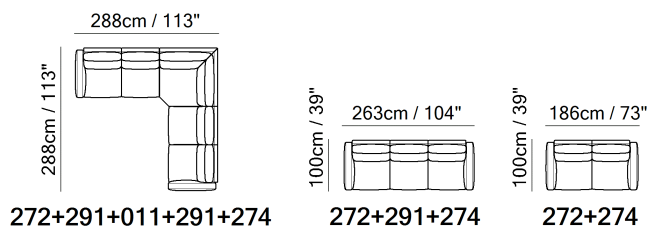

SCHEMATICS



COMPOSITION EXAMPLES



TECHNICAL INFORMATION

	<b>COVERING</b>	Leather <input checked="" type="checkbox"/>	Soft Cover <input checked="" type="checkbox"/>				
	<b>FILLING</b>	Arms	<input type="checkbox"/> Fiber <input checked="" type="checkbox"/> Foam <input type="checkbox"/> Feather/Fiber Mix <input type="checkbox"/> Feather	Seat cushion	<input type="checkbox"/> Fiber <input checked="" type="checkbox"/> Foam <input type="checkbox"/> Feather/Fiber Mix <input type="checkbox"/> Feather	Back cushion	<input type="checkbox"/> Fiber <input checked="" type="checkbox"/> Foam <input type="checkbox"/> Feather/Fiber Mix <input type="checkbox"/> Feather
	<b>COMFORT</b>	Firm Comfort <input checked="" type="checkbox"/>	Standard Comfort <input checked="" type="checkbox"/>				
	<b>FUNCTION</b>	Bed <input type="checkbox"/>	Electric motion <input type="checkbox"/>	Motion <input checked="" type="checkbox"/>	Recliner <input checked="" type="checkbox"/>	Sliding <input type="checkbox"/>	
	<b>VISUAL APPEARANCE*</b>	Low <input checked="" type="checkbox"/>	Medium <input type="checkbox"/>	High <input type="checkbox"/>			
	<b>LEGS</b>	Metal <input type="checkbox"/>	Wood <input type="checkbox"/>	Upholstered <input type="checkbox"/>	Castors <input type="checkbox"/>	Plastic <input checked="" type="checkbox"/>	

VISUAL APPEARANCE

The product may reveal various wrinkles due to the combination of Elasticity of the covering, characteristics of the interior construction and the design of the product.



Products with Visual Appearance listed as High or Medium would require higher degree of care, where seats and back cushions may require fluffing and plumping more often than Products with Visual Appearance listed as Low.

NOTES

- Available in leather or fabric.
- New generation dual power motion recliner: lift/gliding headrest and footrest recliner. Functions operated by power switch located on outside panel of the arm which also allocates a USB charging port.
- The armless relax seats have an upholstered switch flap on the side that can be easily hidden between the seats to activate the mechanism.
- The switch for version chair without arms with mechanism (versions 338/F38/F25), is on the left hand side of the seat (front view)
- A battery pack can be ordered with its own version code 830. For order entry please use XX for category and XXX for cover code. In order to optimize the duration of the battery, it is suggested to order one per each motion seat.
- Packaging: Cardboard wrap.

NOTES

---

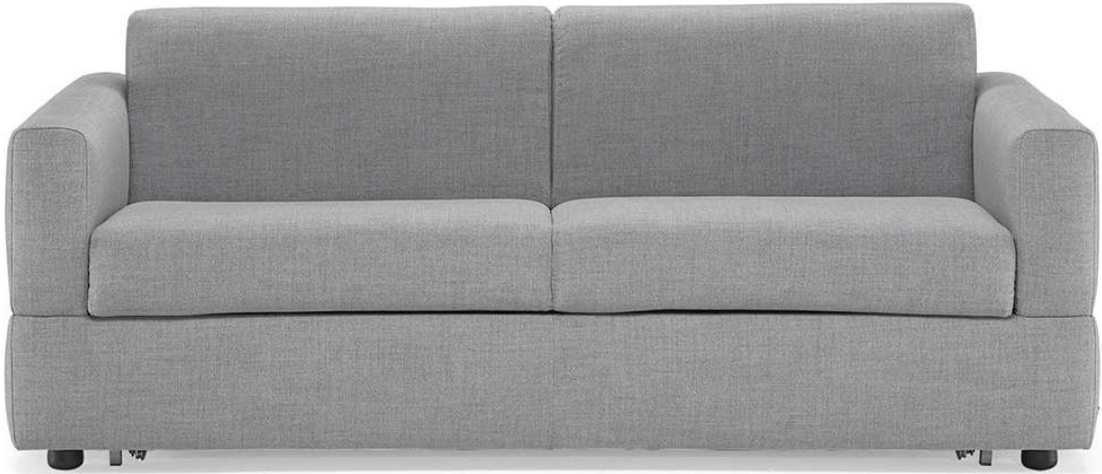

■ Vers. 008



■ Vers. 008







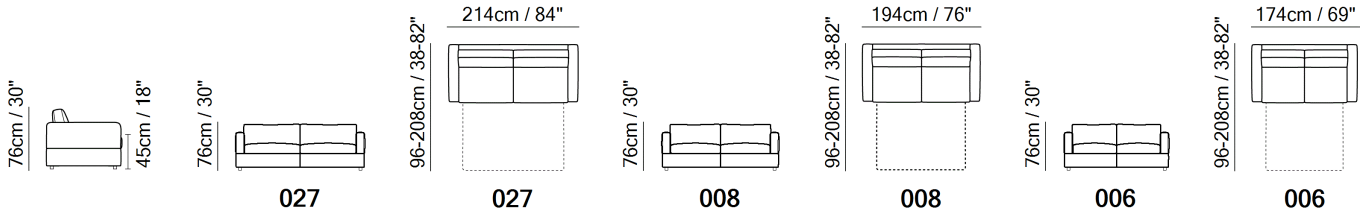

■ Vers. 008

SCHEMATICS



TECHNICAL INFORMATION

	<b>COVERING</b>	Leather <input checked="" type="checkbox"/>	Soft Cover <input checked="" type="checkbox"/>				
	<b>FILLING</b>	Arms	<input type="checkbox"/> Fiber <input checked="" type="checkbox"/> Foam <input type="checkbox"/> Feather/Fiber Mix <input type="checkbox"/> Feather	Seat cushion	<input type="checkbox"/> Fiber <input checked="" type="checkbox"/> Foam <input type="checkbox"/> Feather/Fiber Mix <input type="checkbox"/> Feather	Back cushion	<input type="checkbox"/> Fiber <input checked="" type="checkbox"/> Foam <input type="checkbox"/> Feather/Fiber Mix <input type="checkbox"/> Feather
	<b>COMFORT</b>	Standard Comfort <input checked="" type="checkbox"/>	Firm Comfort <input type="checkbox"/>				
	<b>FUNCTION</b>	Bed <input checked="" type="checkbox"/>	Electric motion <input type="checkbox"/>	Motion <input type="checkbox"/>	Recliner <input type="checkbox"/>	Sliding <input type="checkbox"/>	
	<b>VISUAL APPEARANCE*</b>	Low <input checked="" type="checkbox"/>	Medium <input type="checkbox"/>	High <input type="checkbox"/>			
	<b>LEGS</b>	Wood <input type="checkbox"/>	Metal <input type="checkbox"/>	Upholstered <input type="checkbox"/>	Plastic <input checked="" type="checkbox"/>	Castors <input type="checkbox"/>	

VISUAL APPEARANCE

The product may reveal various wrinkles due to the combination of Elasticity of the covering, characteristics of the interior construction and the design of the product.



Products with Visual Appearance listed as High or Medium would require higher degree of care, where seats and back cushions may require fluffing and plumping more often than Products with Visual Appearance listed as Low.

BED MECHANISM & MATTRESS

MECHANISM		MATTRESS		
VERSIONS	TYPE	VERSIONS	TYPE	DIMENSIONS
006	Ready-Bed electro-welded - Double folding	006	Polyurethane foam	W L H 120 190 13
008	Ready-Bed electro-welded - Double folding	008	Polyurethane foam	140 190 13
		027	Polyurethane foam	160 190 13

**Ready-Bed electro-welded** The back cushion goes under the bed mechanism.

NOTES

- Available in leather (TG only) or fabric.
- All arms, back and seat surfaces are covered in Top Grain.
- This model is available with split leather exterior covering (Side, Rear and Front Panels)
- Tight Seat Cushion (the seat cushions of the models are fixed to the frame)
- Tight Back Cushion (the back cushions of the models are fixed to the frame)
- Internal wooden frame.
- The model will be wrapped in a plastic bag.

NOTES

---



■ Vers. 450+338+452



■ Vers. 446



■ Vers.



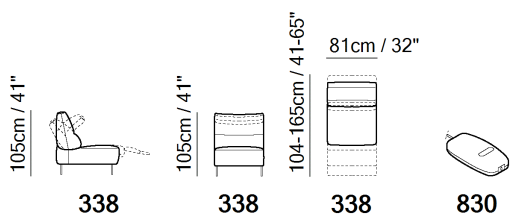
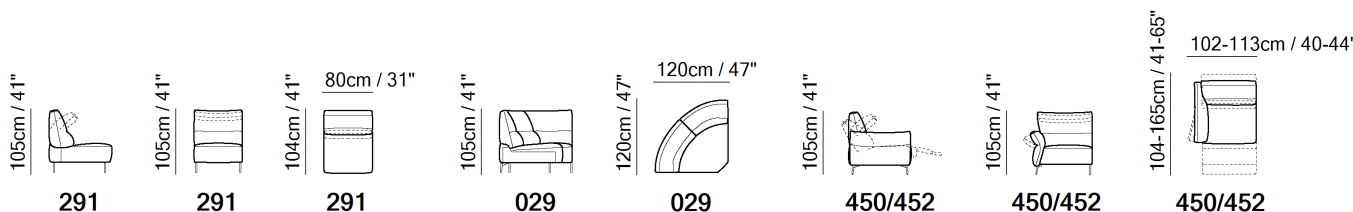
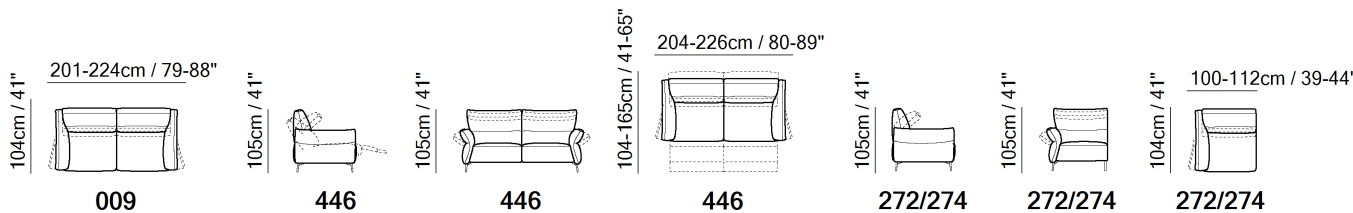
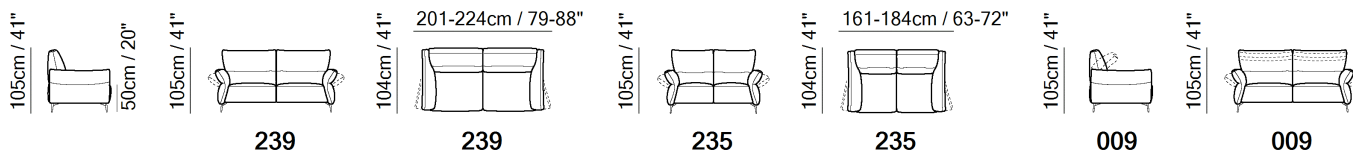

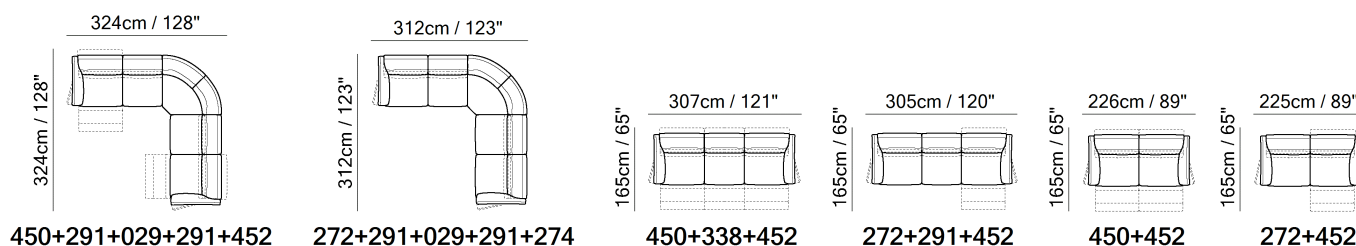

SCHEMATICS



COMPOSITION EXAMPLES



TECHNICAL INFORMATION

	<b>COVERING</b>	Leather <input checked="" type="checkbox"/>	Soft Cover <input checked="" type="checkbox"/>				
	<b>FILLING</b>	Arms	<input type="checkbox"/> Fiber <input checked="" type="checkbox"/> Foam <input type="checkbox"/> Feather/Fiber Mix <input type="checkbox"/> Feather	Seat cushion	<input type="checkbox"/> Fiber <input checked="" type="checkbox"/> Foam <input type="checkbox"/> Feather/Fiber Mix <input type="checkbox"/> Feather	Back cushion	<input type="checkbox"/> Fiber <input checked="" type="checkbox"/> Foam <input type="checkbox"/> Feather/Fiber Mix <input type="checkbox"/> Feather
	<b>COMFORT</b>	Firm Comfort <input checked="" type="checkbox"/>	Standard Comfort <input checked="" type="checkbox"/>				
	<b>FUNCTION</b>	Bed <input type="checkbox"/>	Electric motion <input checked="" type="checkbox"/>	Motion <input checked="" type="checkbox"/>	Recliner <input type="checkbox"/>	Sliding <input type="checkbox"/>	
	<b>VISUAL APPEARANCE*</b>	Low <input type="checkbox"/>	Medium <input type="checkbox"/>	High <input checked="" type="checkbox"/>			
	<b>LEGS</b>	Metal <input checked="" type="checkbox"/>	Wood <input checked="" type="checkbox"/>	Castors <input type="checkbox"/>	Plastic <input type="checkbox"/>	Upholstered <input type="checkbox"/>	

VISUAL APPEARANCE

The product may reveal various wrinkles due to the combination of Elasticity of the covering, characteristics of the interior construction and the design of the product.



Products with Visual Appearance listed as High or Medium would require higher degree of care, where seats and back cushions may require fluffing and plumping more often than Products with Visual Appearance listed as Low.

NOTES

- Available in leather (TG only) or fabric.
- Ergocert Certified. Human-Centered Design certification by Ergocert, is the first European ergonomics certification body. This certification guarantees that the entire design and production process has been completed by listening to the needs of the end user to create and offer an effective and unique comfort experience.
- Version 239 (sofa 3 seater with 2 cushions) has the friction mechanism available for the arms only while version 009 has friction mechanism available for both arms and back cushion.
- Soft arm and high backrest equipped with friction mechanisms to provide unparalleled comfort.
- Soft touch sensors, positioned on the inside of the arm, operate a fluid motion footrest recliner.
- Headrest should be moved always forward and never backwards because it may ruin the front part of the covering.
- The armless relax seats have an upholstered switch flap on the side that can be easily hidden between the seats to activate the mechanism.
- The switch for version chair without arms with mechanism (versions 338/F38/F25), is on the left hand side of the seat (front view)

## NOTES

---

- A battery pack can be ordered with its own version code 830. For order entry please use XX for category and XXX for cover code. In order to optimize the duration of the battery, it is suggested to order one per each motion seat.
- Legs available in both metal or wood; finishing to be selected as an option in nares, the version remains the same.
- Feet available in wood finishings 09 (Walnut) / 18 (Wengè)
- Feet available in metal finishing 78 (Black Chrome)
- Packaging: Cardboard wrap.



■ Vers. 765+436+769



■ Vers. 765+436+769



■ Vers. 763+753+673+755



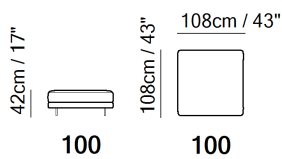
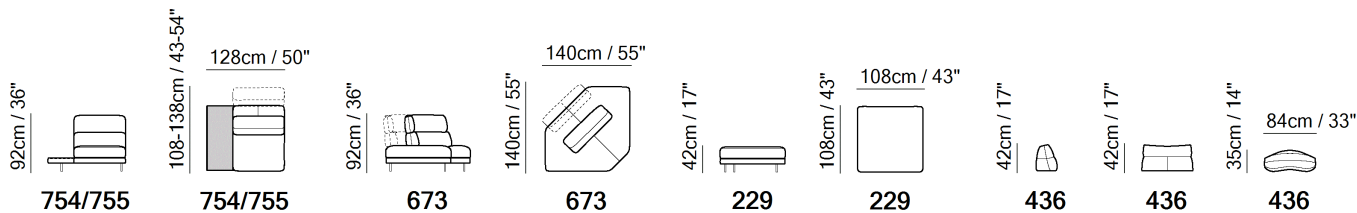
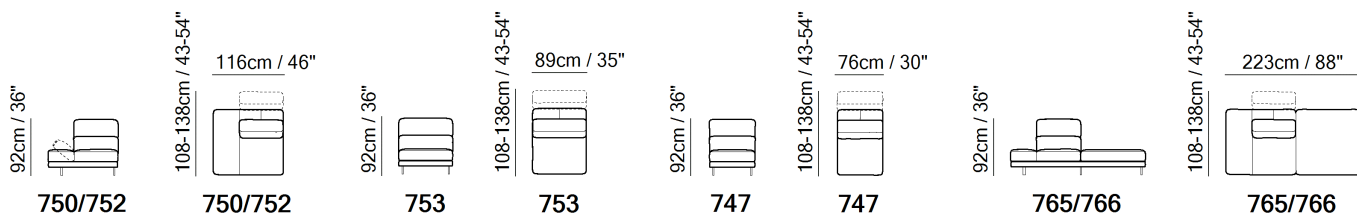
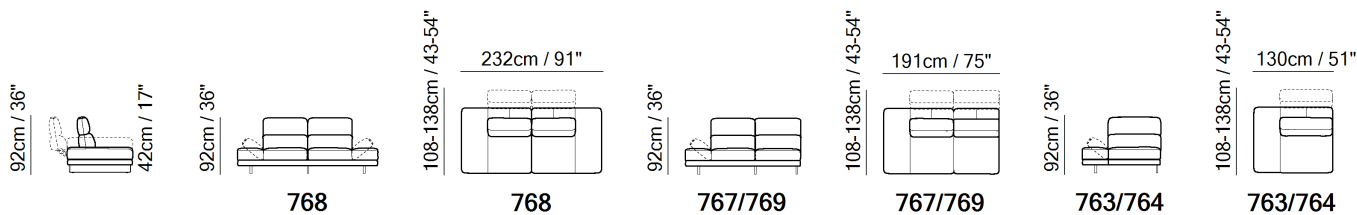

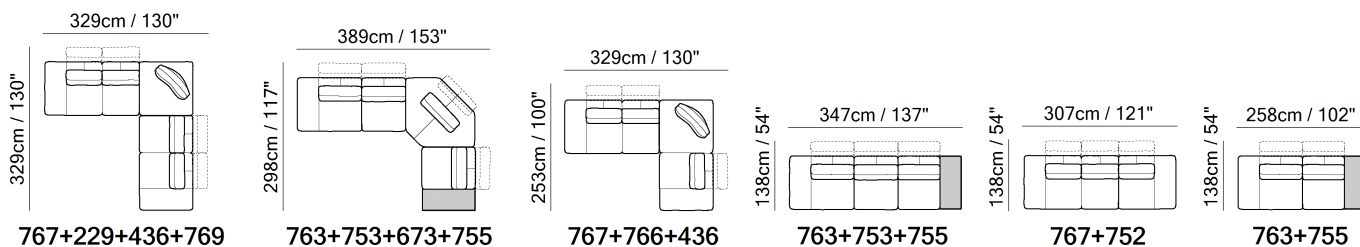

SCHEMATICS



COMPOSITION EXAMPLES



TECHNICAL INFORMATION

	<b>COVERING</b>	Soft Cover <input checked="" type="checkbox"/>				
	<b>FILLING</b>	<b>Arms</b> <input type="checkbox"/> Fiber <input checked="" type="checkbox"/> Foam <input type="checkbox"/> Feather/Fiber Mix <input type="checkbox"/> Feather	<b>Seat cushion</b> <input type="checkbox"/> Fiber <input checked="" type="checkbox"/> Foam <input type="checkbox"/> Feather/Fiber Mix <input type="checkbox"/> Feather	<b>Back cushion</b> <input type="checkbox"/> Fiber <input checked="" type="checkbox"/> Foam <input type="checkbox"/> Feather/Fiber Mix <input type="checkbox"/> Feather		
	<b>COMFORT</b>	Standard Comfort <input checked="" type="checkbox"/>	Firm Comfort <input checked="" type="checkbox"/>			
	<b>FUNCTION</b>	Bed <input type="checkbox"/>	Electric motion <input type="checkbox"/>	Motion <input type="checkbox"/>	Recliner <input type="checkbox"/>	Sliding <input type="checkbox"/>
	<b>VISUAL APPEARANCE*</b>	Low <input type="checkbox"/>	Medium <input checked="" type="checkbox"/>	High <input type="checkbox"/>		
	<b>LEGS</b>	Wood <input type="checkbox"/>	Metal <input checked="" type="checkbox"/>	Upholstered <input type="checkbox"/>	Plastic <input type="checkbox"/>	Castors <input type="checkbox"/>

VISUAL APPEARANCE

The product may reveal various wrinkles due to the combination of Elasticity of the covering, characteristics of the interior construction and the design of the product.



Products with Visual Appearance listed as High or Medium would require higher degree of care, where seats and back cushions may require fluffing and plumping more often than Products with Visual Appearance listed as Low.

NOTES

- Model is available in fabric only.
- Model Roma is available in fabric with code C257 and in leather with code X257. The versions of the models can be combined with each other.
- Manually adjustable backrest through a tilting mechanism: 2 positions, back and forth.
- Manually adjustable arm with ratchet mechanism.
- Versions 754/755 (large armless chair with left/right terminal and adj. backrest) include a ceramic side top on the terminal in jazz white finishing only.
- New modular sectional versions that allow compact configuration solutions by also combining new additional elements such as the “self-standing backrest”. This version has a carefully studied weight placed internally in its base. You can feel free to move it around and place it as needed on the seating surface to easily provide back support.
- 229 version to be used only as a corner while the 100 as a loose ottoman. These versions have same dimensions and look similar, but they differ from each other by the legs positioning.
- To facilitate delivery operations, the backrests will be disassembled and no longer attached to the structure. In the feet box, along with the feet assembly instructions, the backrest assembly instructions will also be included.
- Packaging: Cardboard wrap.
- Feet available in metal finishings 77 (Glossy Chromed) / 79 (Matte Black)

NOTES

---



■ Vers. F45



■ Vers. F45





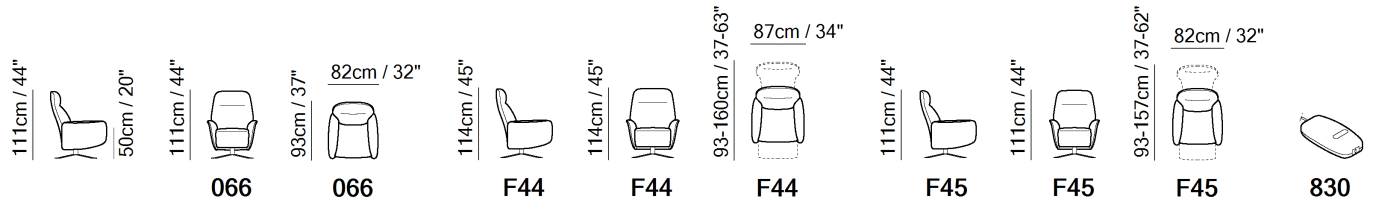

■ Vers. 066

**SCHEMATICS**



TECHNICAL INFORMATION

	<b>COVERING</b>	Leather <input checked="" type="checkbox"/>	Soft Cover <input checked="" type="checkbox"/>				
	<b>FILLING</b>	Arms	<input type="checkbox"/> Fiber <input checked="" type="checkbox"/> Foam <input type="checkbox"/> Feather/Fiber Mix <input type="checkbox"/> Feather	Seat cushion	<input type="checkbox"/> Fiber <input checked="" type="checkbox"/> Foam <input type="checkbox"/> Feather/Fiber Mix <input type="checkbox"/> Feather	Back cushion	<input type="checkbox"/> Fiber <input checked="" type="checkbox"/> Foam <input type="checkbox"/> Feather/Fiber Mix <input type="checkbox"/> Feather
	<b>COMFORT</b>	Firm Comfort <input type="checkbox"/>	Standard Comfort <input checked="" type="checkbox"/>				
	<b>FUNCTION</b>	Bed <input type="checkbox"/>	Electric motion <input type="checkbox"/>	Motion <input type="checkbox"/>	Recliner <input type="checkbox"/>	Sliding <input type="checkbox"/>	
	<b>VISUAL APPEARANCE*</b>	Low <input checked="" type="checkbox"/>	Medium <input type="checkbox"/>	High <input type="checkbox"/>			
	<b>LEGS</b>	Metal <input checked="" type="checkbox"/>	Wood <input type="checkbox"/>	Castors <input type="checkbox"/>	Plastic <input type="checkbox"/>	Upholstered <input type="checkbox"/>	

VISUAL APPEARANCE

The product may reveal various wrinkles due to the combination of Elasticity of the covering, characteristics of the interior construction and the design of the product.



Products with Visual Appearance listed as High or Medium would require higher degree of care, where seats and back cushions may require fluffing and plumping more often than Products with Visual Appearance listed as Low.

NOTES

- Available in leather (TG only) or fabric.
- Dual power motion recliner: headrest and footrest
- Available in two different sizes: King size (version F44) and Queen size (F45). Compared to the queen version, the king version is taller and wider.
- The chair is also available as a swivel (version 066) in one dimension only (same as the queen version)
- A battery pack can be ordered with its own version code 830. For order entry please use XX for category and XXX for cover code. In order to optimize the duration of the battery, it is suggested to order one per each motion seat.
- The model has external switch on the side panel to activate the mechanism.
- Metal base available in unique metal finishing anthracite.
- Packaging: Cardboard wrap.

NOTES

---



■ Vers. 064



■ Vers. 216+291+011+217



■ Vers. 066



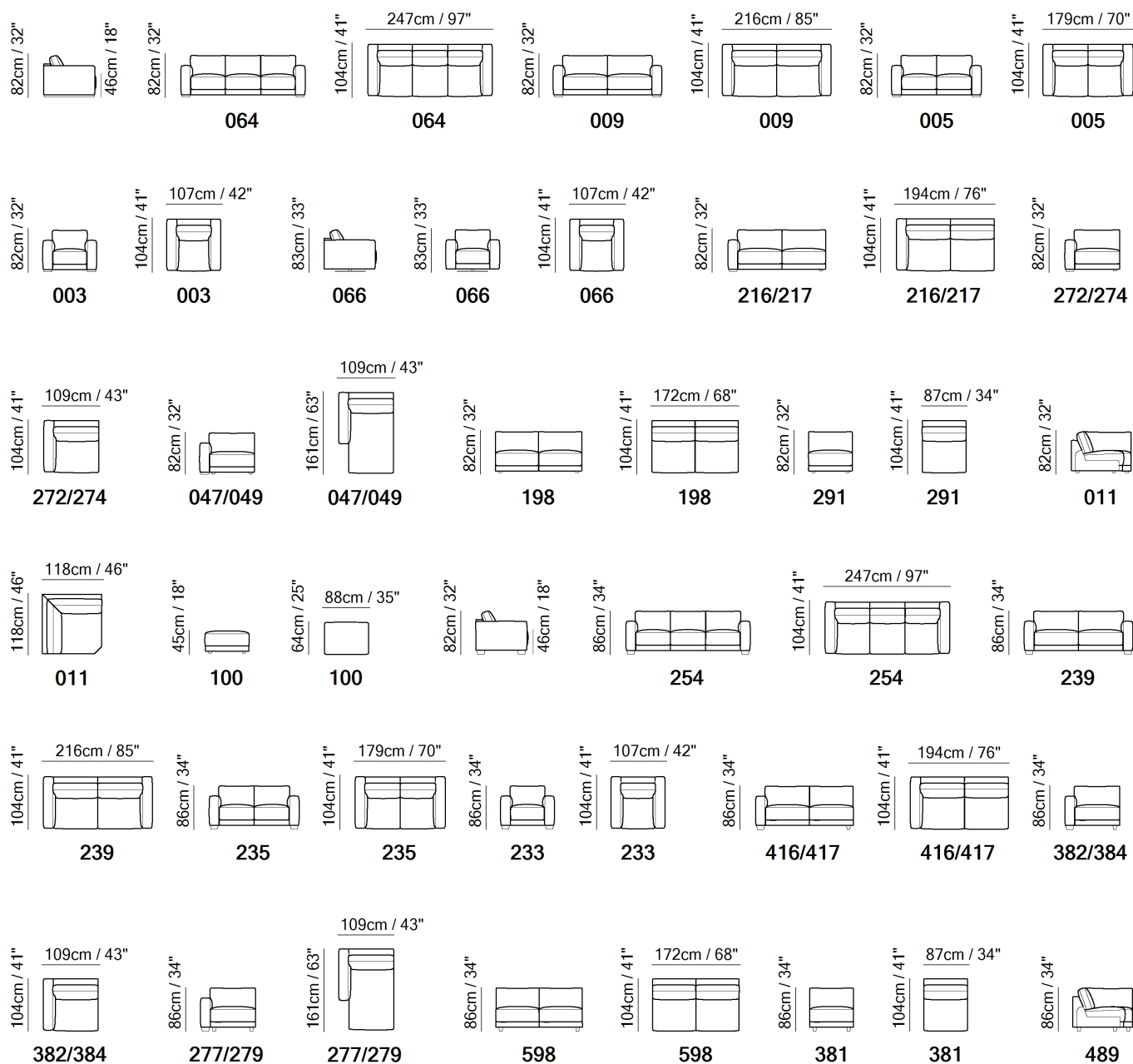

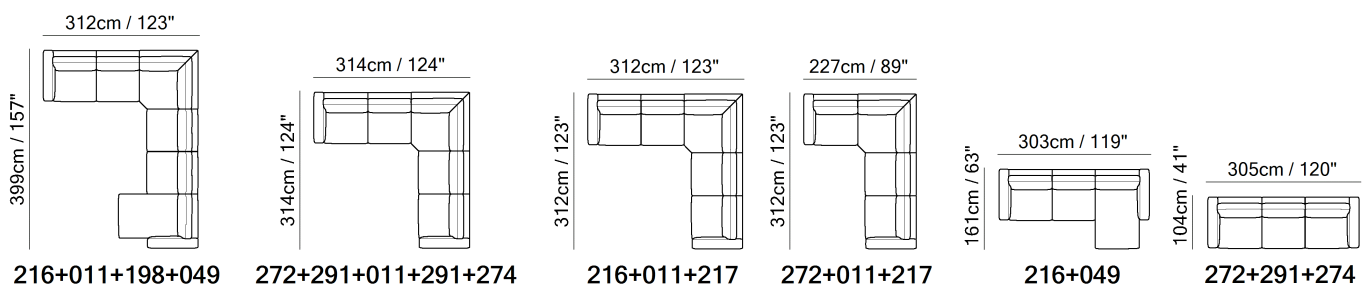

SCHEMATICS



COMPOSITION EXAMPLES



TECHNICAL INFORMATION

	<b>COVERING</b>	Leather <input checked="" type="checkbox"/>	Soft Cover <input checked="" type="checkbox"/>				
	<b>FILLING</b>	Arms	<input type="checkbox"/> Fiber <input checked="" type="checkbox"/> Foam <input type="checkbox"/> Feather/Fiber Mix <input type="checkbox"/> Feather	Seat cushion	<input type="checkbox"/> Fiber <input checked="" type="checkbox"/> Foam <input type="checkbox"/> Feather/Fiber Mix <input type="checkbox"/> Feather	Back cushion	<input type="checkbox"/> Fiber <input checked="" type="checkbox"/> Foam <input type="checkbox"/> Feather/Fiber Mix <input type="checkbox"/> Feather
	<b>COMFORT</b>	Standard Comfort <input checked="" type="checkbox"/>	Firm Comfort <input checked="" type="checkbox"/>				
	<b>FUNCTION</b>	Bed <input type="checkbox"/>	Electric motion <input type="checkbox"/>	Motion <input type="checkbox"/>	Recliner <input type="checkbox"/>	Sliding <input type="checkbox"/>	
	<b>VISUAL APPEARANCE*</b>	Low <input type="checkbox"/>	Medium <input checked="" type="checkbox"/>	High <input type="checkbox"/>			
	<b>LEGS</b>	Wood <input checked="" type="checkbox"/>	Metal <input type="checkbox"/>	Upholstered <input type="checkbox"/>	Plastic <input type="checkbox"/>	Castors <input type="checkbox"/>	

VISUAL APPEARANCE

The product may reveal various wrinkles due to the combination of Elasticity of the covering, characteristics of the interior construction and the design of the product.



Products with Visual Appearance listed as High or Medium would require higher degree of care, where seats and back cushions may require fluffing and plumping more often than Products with Visual Appearance listed as Low.

NOTES

- Available in leather (TG only) or fabric.
- Second option versions have a different (simplified) wood leg with a taller height compared to the original (std versions). The different legs lead to a different seat height you can select as an option.  
Important Note! In selecting a sectional configuration, make sure you use the either std versions only or 2nd option versions only, in order to get the same overall height on the sectional.
- Packaging: Cardboard wrap.
- Feet available in wood finishings 09 (Walnut) / 18 (Wengè)

**NOTES**

---



■ Vers. F50+F38+F52



■ Vers. F46



■ Vers. F00+001+489+F25+F02



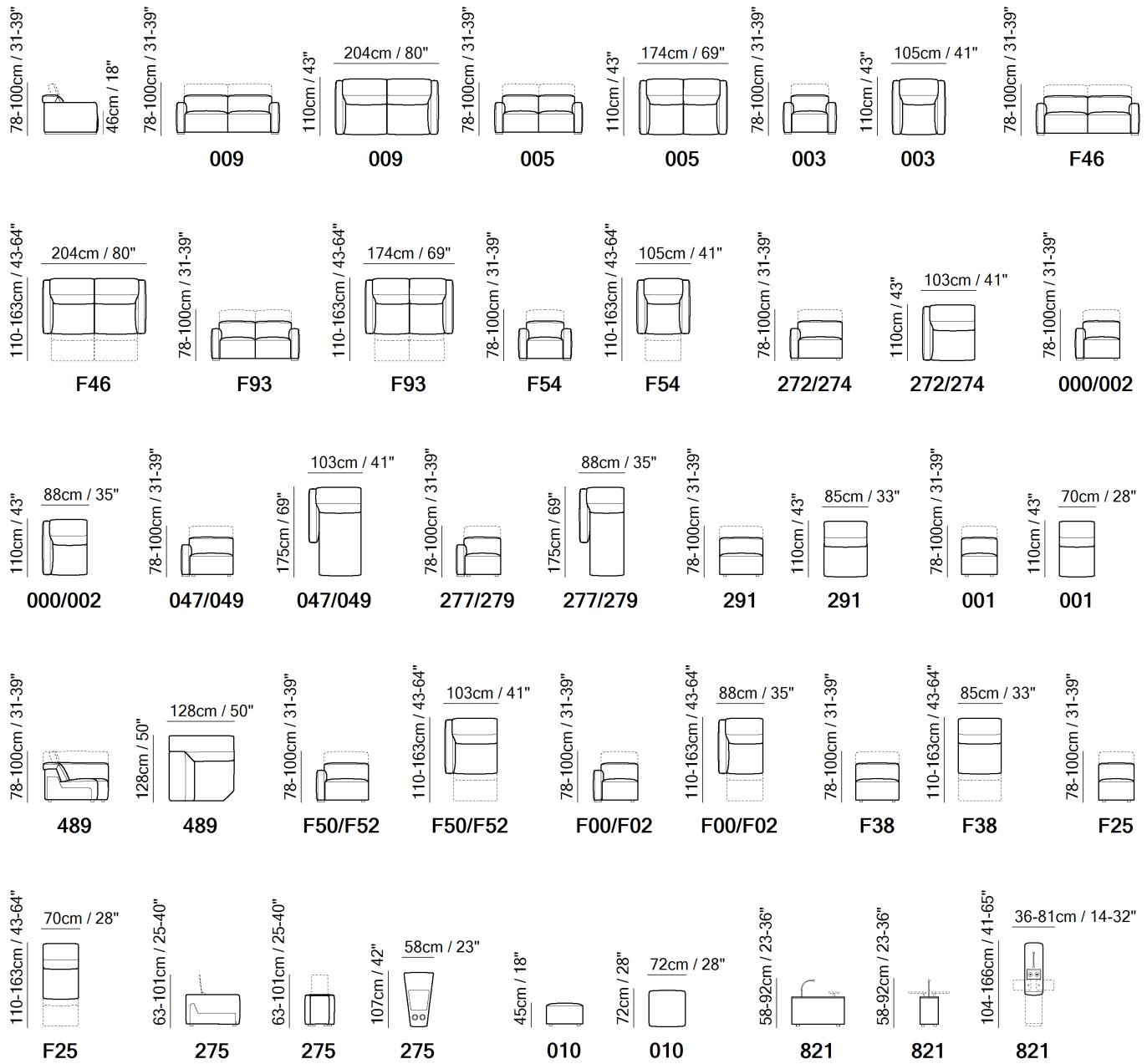

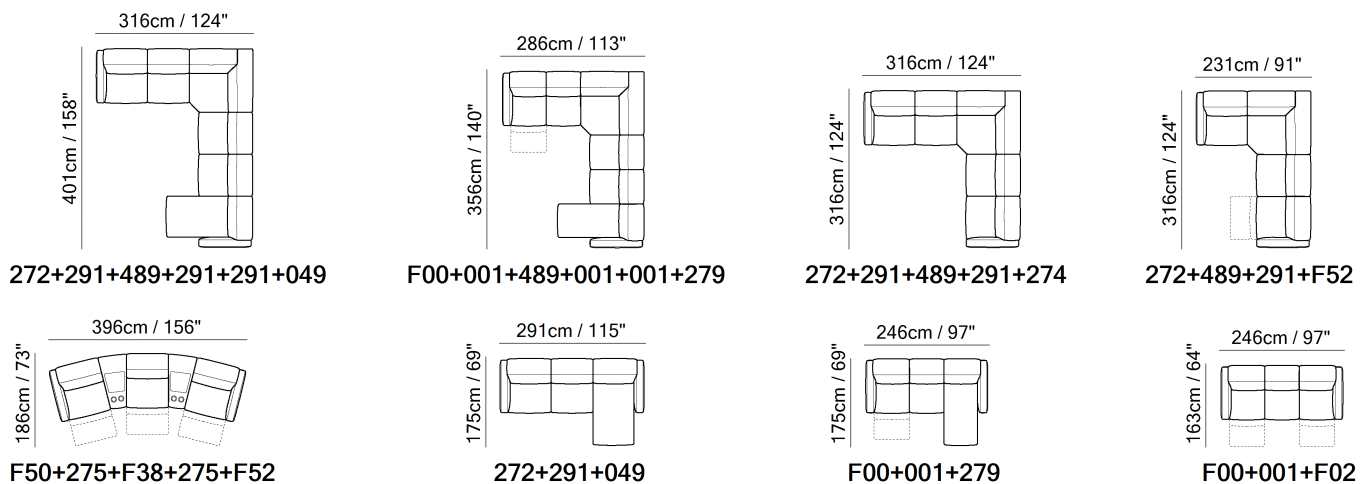

SCHEMATICS



COMPOSITION EXAMPLES



TECHNICAL INFORMATION

	<b>COVERING</b>	Leather <input checked="" type="checkbox"/>	Soft Cover <input checked="" type="checkbox"/>				
	<b>FILLING</b>	Arms	<input type="checkbox"/> Fiber <input checked="" type="checkbox"/> Foam <input type="checkbox"/> Feather/Fiber Mix <input type="checkbox"/> Feather	Seat cushion	<input type="checkbox"/> Fiber <input checked="" type="checkbox"/> Foam <input type="checkbox"/> Feather/Fiber Mix <input type="checkbox"/> Feather	Back cushion	<input type="checkbox"/> Fiber <input checked="" type="checkbox"/> Foam <input type="checkbox"/> Feather/Fiber Mix <input type="checkbox"/> Feather
	<b>COMFORT</b>	Firm Comfort <input checked="" type="checkbox"/>	Standard Comfort <input checked="" type="checkbox"/>				
	<b>FUNCTION</b>	Bed <input type="checkbox"/>	Electric motion <input type="checkbox"/>	Motion <input checked="" type="checkbox"/>	Recliner <input checked="" type="checkbox"/>	Sliding <input type="checkbox"/>	
	<b>VISUAL APPEARANCE*</b>	Low <input type="checkbox"/>	Medium <input checked="" type="checkbox"/>	High <input type="checkbox"/>			
	<b>LEGS</b>	Metal <input type="checkbox"/>	Wood <input checked="" type="checkbox"/>	Castors <input type="checkbox"/>	Plastic <input type="checkbox"/>	Upholstered <input type="checkbox"/>	

VISUAL APPEARANCE

The product may reveal various wrinkles due to the combination of Elasticity of the covering, characteristics of the interior construction and the design of the product.



Products with Visual Appearance listed as High or Medium would require higher degree of care, where seats and back cushions may require fluffing and plumping more often than Products with Visual Appearance listed as Low.

NOTES

- Available in leather (TG only) or fabric.
- Model Baltimora can be ordered with quilted back cushions using model code X260 or with plain back cushions with model code C260.
- The multifunctional console, with a full wooden finish, features a spacious tabletop, a storage drawer, a built-in USB port, and connectors for adding optional features—blending style, convenience, and versatility. The console can be ordered with its own version code 821 or 823. For order entry please use XXX for alias code and finishing code ST49 ash brown or ST50 ash blonde.
- Dual power motion recliner: headrest and footrest
- Functions are operated by the power switch located on outside panel of the arm which also allocates a USB charging port.
- The armless relax seats have an upholstered switch flap on the side that can be easily hidden between the seats to activate the mechanism.
- The switch for version chair without arms with mechanism (versions 338/F38/F25), is on the left hand side of the seat (front view)
- A battery pack can be ordered with its own version code 830. For order entry please use XX for category and XXX for cover code. In order to optimize the duration of the battery, it is suggested to order one per each motion seat.
- Packaging: plastic wrap for stationary versions and cardboard box for motion/sofabed versions

## NOTES

---

- Feet available in wood finishings 09 (Walnut) / 18 (Wengè)



■ Vers. 450+338+452



■ Vers. 450+338+452



■ Vers. 009



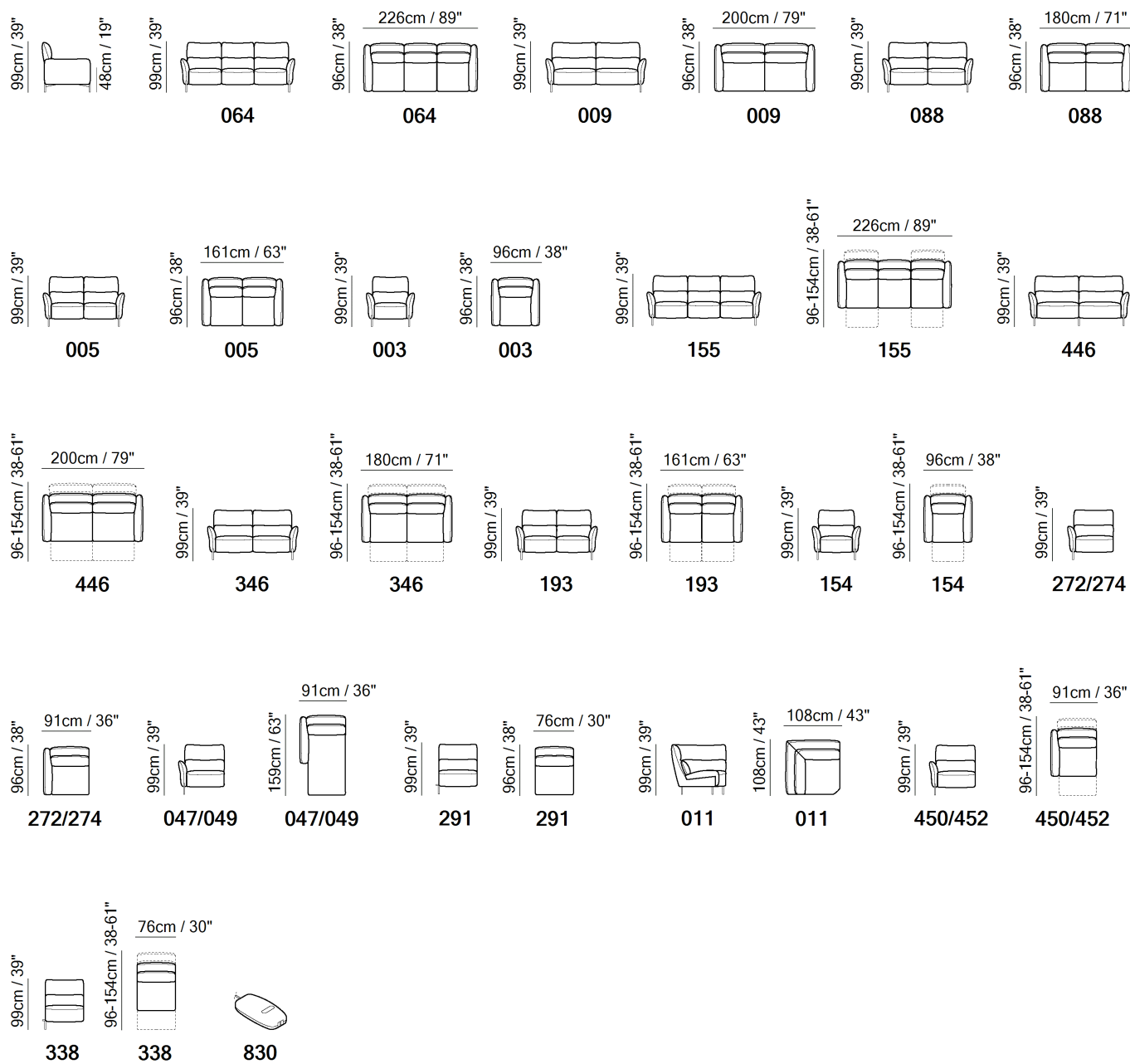

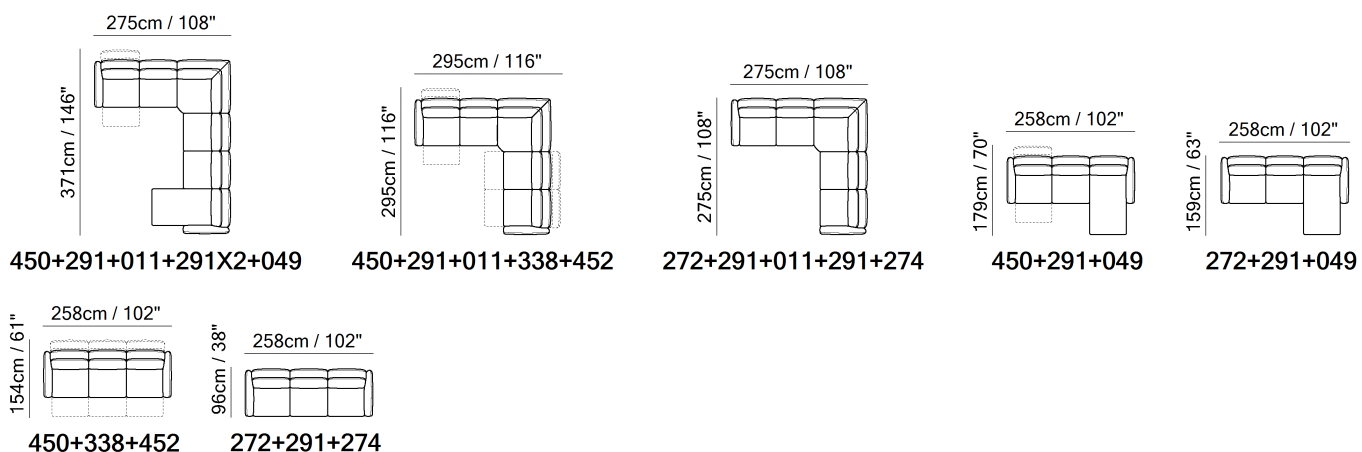

SCHEMATICS



COMPOSITION EXAMPLES



TECHNICAL INFORMATION

	<b>COVERING</b>	Leather <input checked="" type="checkbox"/>	Soft Cover <input checked="" type="checkbox"/>				
	<b>FILLING</b>	Arms	<input type="checkbox"/> Fiber <input checked="" type="checkbox"/> Foam <input type="checkbox"/> Feather/Fiber Mix <input type="checkbox"/> Feather	Seat cushion	<input type="checkbox"/> Fiber <input checked="" type="checkbox"/> Foam <input type="checkbox"/> Feather/Fiber Mix <input type="checkbox"/> Feather	Back cushion	<input type="checkbox"/> Fiber <input checked="" type="checkbox"/> Foam <input type="checkbox"/> Feather/Fiber Mix <input type="checkbox"/> Feather
	<b>COMFORT</b>	Standard Comfort <input checked="" type="checkbox"/>	Firm Comfort <input checked="" type="checkbox"/>				
	<b>FUNCTION</b>	Bed <input type="checkbox"/>	Electric motion <input checked="" type="checkbox"/>	Motion <input checked="" type="checkbox"/>	Recliner <input checked="" type="checkbox"/>	Sliding <input type="checkbox"/>	
	<b>VISUAL APPEARANCE*</b>	Low <input checked="" type="checkbox"/>	Medium <input type="checkbox"/>	High <input type="checkbox"/>			
	<b>LEGS</b>	Wood <input type="checkbox"/>	Metal <input checked="" type="checkbox"/>	Upholstered <input type="checkbox"/>	Plastic <input type="checkbox"/>	Castors <input type="checkbox"/>	

VISUAL APPEARANCE

The product may reveal various wrinkles due to the combination of Elasticity of the covering, characteristics of the interior construction and the design of the product.



Products with Visual Appearance listed as High or Medium would require higher degree of care, where seats and back cushions may require fluffing and plumping more often than Products with Visual Appearance listed as Low.

NOTES

- Available in leather (TG only) or fabric.
- Compared to the open base motion models already in collection, this model features a new mechanism that allows to keep clean the sofa bottom, without the wooden shell that usually hide the mechanism under the sofa.
- SINGLE POWER MOTION: Power mechanism that activates a smooth system reclining seat, backrest and footrest for maximum relaxation
- Unique features of its Power Reclining system:
  - allow the headrest to slightly tilt forward simultaneously while reclining to full extent, thanks to a leverage mechanism, delivering optimum support and comfort.
  - allow its off-the-floor underpart to be completely “clear” with no interference, to facilitate “robot vacuum cleaning”.
- Smart touch buttons to activate power reclining functions positioned on the side of the seating
- The armless relax seats have an upholstered switch flap on the side that can be easily hidden between the seats to activate the mechanism.
- The switch for version chair without arms with mechanism (versions 338/F38/F25), is on the left hand side of the seat (front view)
- A battery pack can be ordered with its own version code 830. For order entry please use XX for category and XXX for cover code. In order to optimize the duration of the battery, it is suggested to order one per each motion seat.

## NOTES

---

- Feet available in metal finishing 79 (Matte Black)



■ Vers. F46



■ Vers. F46



■ Vers. 272+291+481



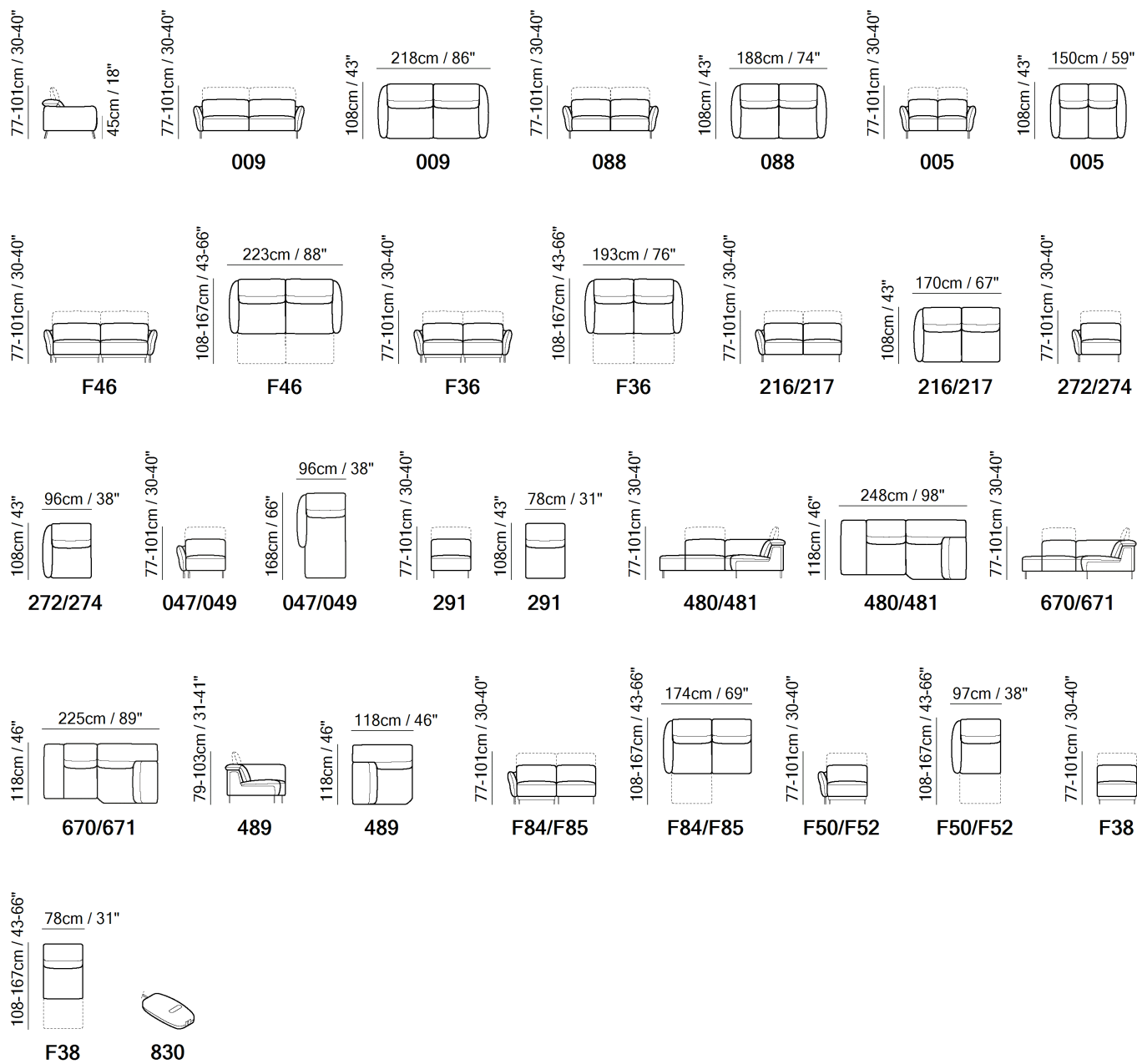

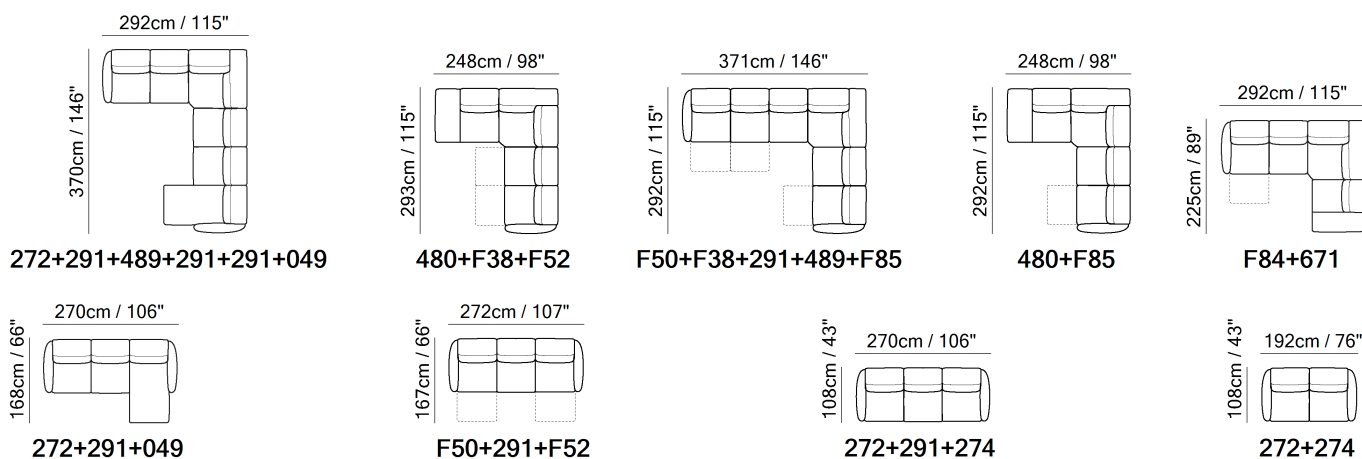

SCHEMATICS



COMPOSITION EXAMPLES



TECHNICAL INFORMATION

	<b>COVERING</b>	Leather <input checked="" type="checkbox"/>	Soft Cover <input checked="" type="checkbox"/>			
	<b>FILLING</b>	Arms <input type="checkbox"/> Fiber <input checked="" type="checkbox"/> Foam <input type="checkbox"/> Feather/Fiber Mix <input type="checkbox"/> Feather	Seat cushion <input type="checkbox"/> Fiber <input checked="" type="checkbox"/> Foam <input type="checkbox"/> Feather/Fiber Mix <input type="checkbox"/> Feather	Back cushion <input type="checkbox"/> Fiber <input checked="" type="checkbox"/> Foam <input type="checkbox"/> Feather/Fiber Mix <input type="checkbox"/> Feather		
	<b>COMFORT</b>	Firm Comfort <input checked="" type="checkbox"/>	Standard Comfort <input checked="" type="checkbox"/>			
	<b>FUNCTION</b>	Bed <input type="checkbox"/>	Electric motion <input type="checkbox"/>	Motion <input checked="" type="checkbox"/>	Recliner <input type="checkbox"/>	Sliding <input type="checkbox"/>
	<b>VISUAL APPEARANCE*</b>	Low <input checked="" type="checkbox"/>	Medium <input type="checkbox"/>	High <input type="checkbox"/>		
	<b>LEGS</b>	Metal <input checked="" type="checkbox"/>	Wood <input type="checkbox"/>	Castors <input type="checkbox"/>	Plastic <input type="checkbox"/>	Upholstered <input type="checkbox"/>

VISUAL APPEARANCE

The product may reveal various wrinkles due to the combination of Elasticity of the covering, characteristics of the interior construction and the design of the product.



Products with Visual Appearance listed as High or Medium would require higher degree of care, where seats and back cushions may require fluffing and plumping more often than Products with Visual Appearance listed as Low.

NOTES

- Available in leather (TG only) or fabric.
- Ergocert Certified. Human-Centered Design certification by Ergocert, is the first European ergonomics certification body. This certification guarantees that the entire design and production process has been completed by listening to the needs of the end user to create and offer an effective and unique comfort experience.
- Dual power motion recliner: headrest and footrest
- Dual power mechanism with external switch on the side panel that activates recliner and headrest and includes an USB charging port
- The armless recliner seats are equipped with a satin label on the seat cushion side that indicate the position of the internal power switch and can be easily hidden between the seats.
- Stationary versions have manually adjustable headrests.
- A battery pack can be ordered with its own version code 830. For order entry please use XX for category and XXX for cover code. In order to optimize the duration of the battery, it is suggested to order one per each motion seat.
- Feet available in metal finishing 79 (Matte Black)

NOTES

---



■ Vers. N55



■ Vers. N50+291+189



■ Vers. 009



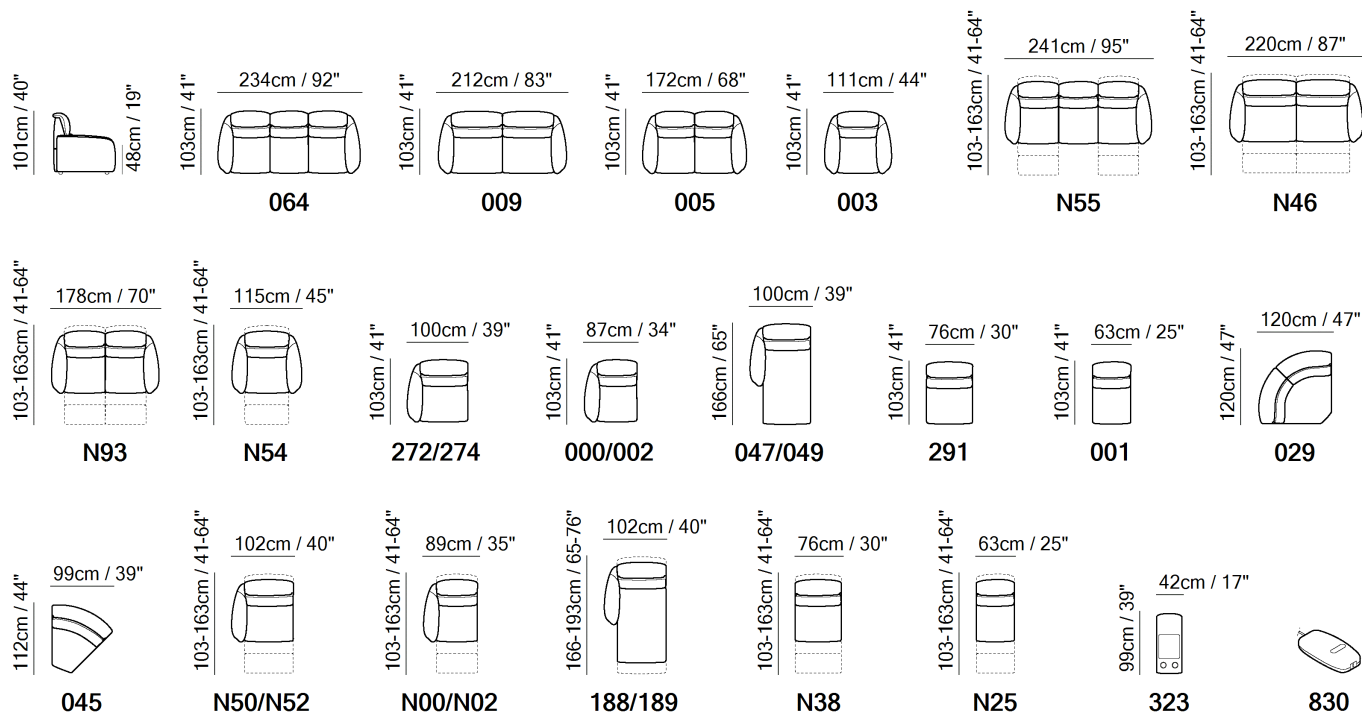

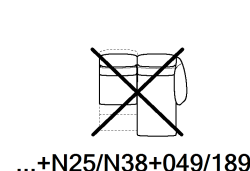
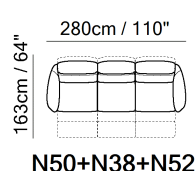
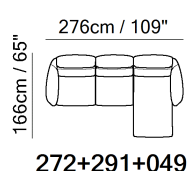
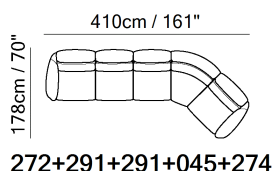
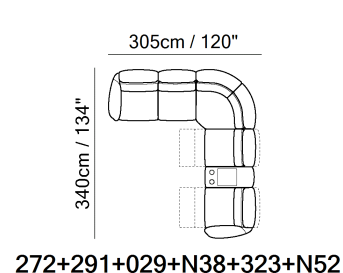
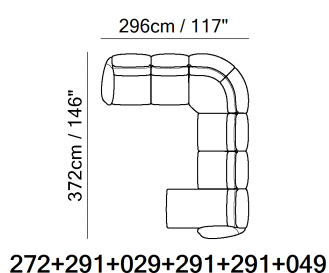
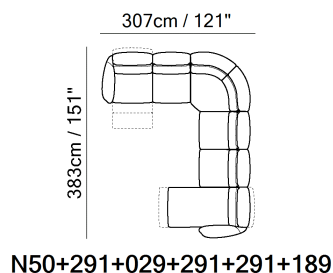

SCHEMATICS



COMPOSITION EXAMPLES



TECHNICAL INFORMATION

	<b>COVERING</b>	Leather <input checked="" type="checkbox"/>	Soft Cover <input checked="" type="checkbox"/>			
	<b>FILLING</b>	Arms <input type="checkbox"/> Fiber <input checked="" type="checkbox"/> Foam <input type="checkbox"/> Feather/Fiber Mix <input type="checkbox"/> Feather	Seat cushion <input type="checkbox"/> Fiber <input checked="" type="checkbox"/> Foam <input type="checkbox"/> Feather/Fiber Mix <input type="checkbox"/> Feather	Back cushion <input type="checkbox"/> Fiber <input checked="" type="checkbox"/> Foam <input type="checkbox"/> Feather/Fiber Mix <input type="checkbox"/> Feather		
	<b>COMFORT</b>	Standard Comfort <input checked="" type="checkbox"/>	Firm Comfort <input checked="" type="checkbox"/>			
	<b>FUNCTION</b>	Bed <input type="checkbox"/>	Electric motion <input checked="" type="checkbox"/>	Motion <input checked="" type="checkbox"/>	Recliner <input checked="" type="checkbox"/>	Sliding <input type="checkbox"/>
	<b>VISUAL APPEARANCE*</b>	Low <input checked="" type="checkbox"/>	Medium <input type="checkbox"/>	High <input type="checkbox"/>		
	<b>LEGS</b>	Wood <input type="checkbox"/>	Metal <input type="checkbox"/>	Upholstered <input type="checkbox"/>	Plastic <input type="checkbox"/>	Castors <input type="checkbox"/>

VISUAL APPEARANCE

The product may reveal various wrinkles due to the combination of Elasticity of the covering, characteristics of the interior construction and the design of the product.



Products with Visual Appearance listed as High or Medium would require higher degree of care, where seats and back cushions may require fluffing and plumping more often than Products with Visual Appearance listed as Low.

NOTES

- Available in leather (TG only) or fabric.
- FABRIC: In fabric contrast welt (or any another decorative detail such as a band under arm cushion) can be made either in same category fabric or in leather with any color of Le Mans (only).
- CUBICOMFORT™ Triple-Motion Technology is a registered trademark. It denotes a set of independent motion systems that activate the various elements of the sofa (seat, backrest, headrest and footrest) allowing each person to adjust their position of absolute comfort to the millimeter.
- Mech. 1: All in One Power Reclining mechanism simultaneously reclines the back and seat and footrest that allows you to reach a horizontal position for unlimited relaxation.
- Mech. 2: Power Lumbar Support allows you to adjust the lower part of the backrest by increasing or decreasing the pressure for a better back support.
- Mech. 3: Power Adjustable Headrest which allows you to recline the headrest forward with millimetric precision and reach a perfect relaxation position for great comfort.
- Equipped with satin label that is intended to indicate the position of the control panel.
- Functions are operated by a three-button power switch located hidden on the seat cushion side.
- A battery pack can be ordered with its own version code 830. For order entry please use XX for category and XXX for cover code. In order to optimize the duration of the battery, it is suggested to order one per each motion seat.

**NOTES**

---



■ Vers. 064



■ Vers. 064





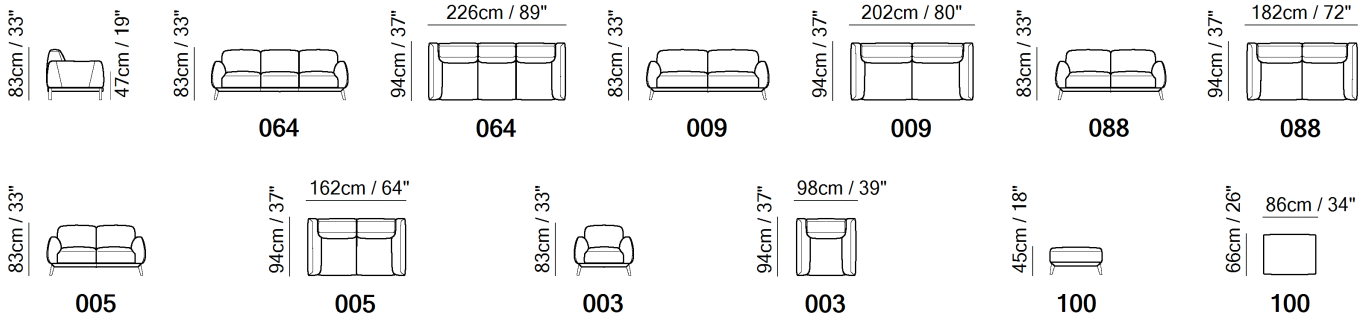

■ Vers. 003

SCHEMATICS



TECHNICAL INFORMATION

	<b>COVERING</b>	Leather <input checked="" type="checkbox"/>	Soft Cover <input checked="" type="checkbox"/>				
	<b>FILLING</b>	Arms	<input type="checkbox"/> Fiber <input checked="" type="checkbox"/> Foam <input type="checkbox"/> Feather/Fiber Mix <input type="checkbox"/> Feather	Seat cushion	<input type="checkbox"/> Fiber <input checked="" type="checkbox"/> Foam <input type="checkbox"/> Feather/Fiber Mix <input type="checkbox"/> Feather	Back cushion	<input type="checkbox"/> Fiber <input checked="" type="checkbox"/> Foam <input type="checkbox"/> Feather/Fiber Mix <input type="checkbox"/> Feather
	<b>COMFORT</b>	Firm Comfort <input checked="" type="checkbox"/>	Standard Comfort <input checked="" type="checkbox"/>				
	<b>FUNCTION</b>	Bed <input type="checkbox"/>	Electric motion <input type="checkbox"/>	Motion <input type="checkbox"/>	Recliner <input type="checkbox"/>	Sliding <input type="checkbox"/>	
	<b>VISUAL APPEARANCE*</b>	Low <input checked="" type="checkbox"/>	Medium <input type="checkbox"/>	High <input type="checkbox"/>			
	<b>LEGS</b>	Metal <input type="checkbox"/>	Wood <input checked="" type="checkbox"/>	Castors <input type="checkbox"/>	Plastic <input type="checkbox"/>	Upholstered <input type="checkbox"/>	

VISUAL APPEARANCE

The product may reveal various wrinkles due to the combination of Elasticity of the covering, characteristics of the interior construction and the design of the product.



Products with Visual Appearance listed as High or Medium would require higher degree of care, where seats and back cushions may require fluffing and plumping more often than Products with Visual Appearance listed as Low.

NOTES

- Available in leather (TG only) or fabric.
- Feet available in wood finishings 09 (Walnut) / 18 (Wengè)

NOTES

---



■ Vers. 064



■ Vers. 217+047



■ Vers. 003



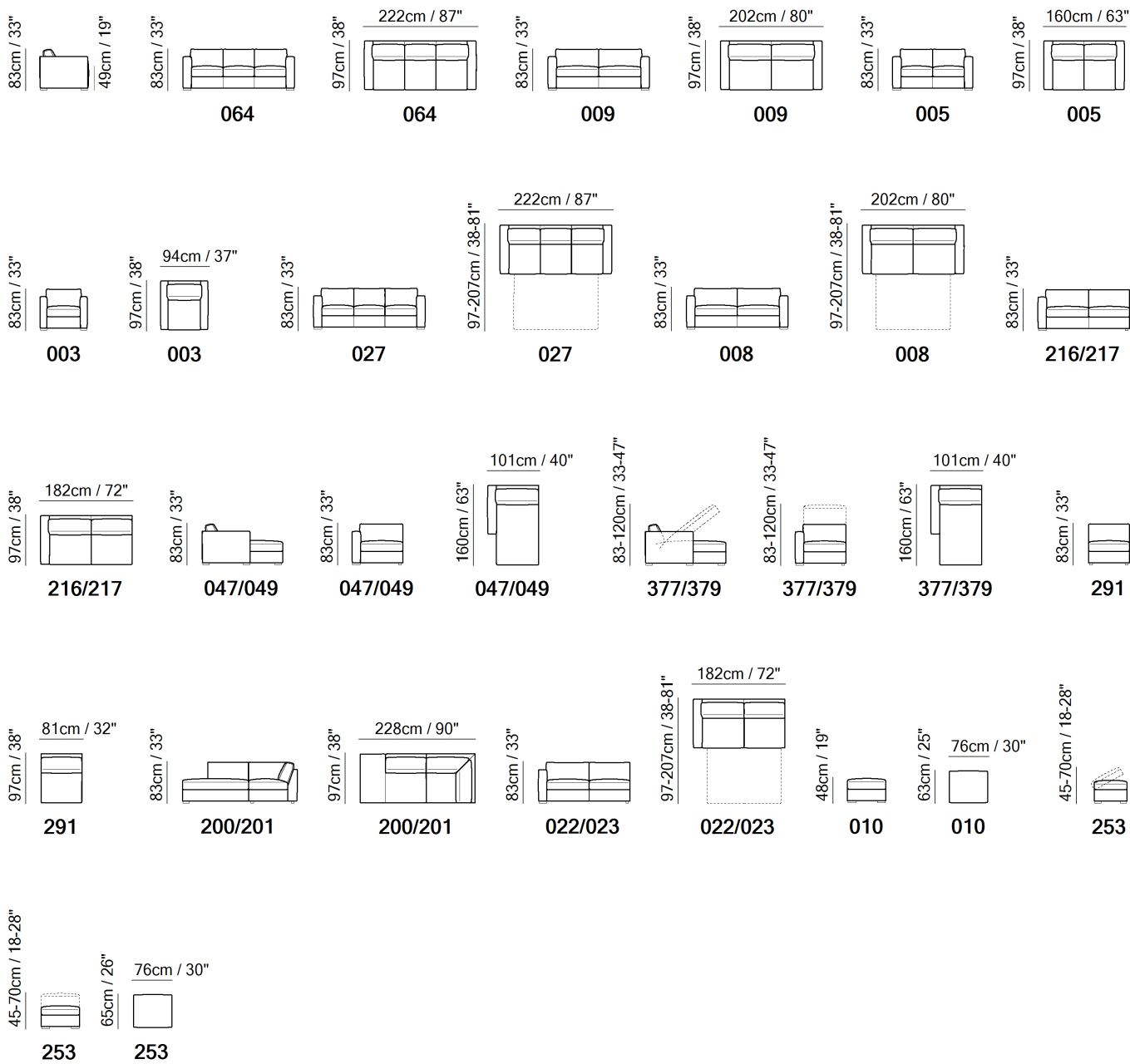

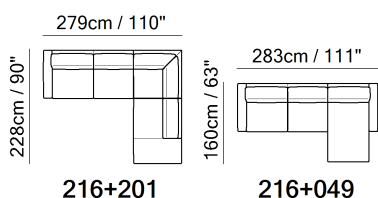

SCHEMATICS



COMPOSITION EXAMPLES



TECHNICAL INFORMATION

	<b>COVERING</b>	Leather <input checked="" type="checkbox"/>	Soft Cover <input checked="" type="checkbox"/>				
	<b>FILLING</b>	Arms	<input type="checkbox"/> Fiber <input checked="" type="checkbox"/> Foam <input type="checkbox"/> Feather/Fiber Mix <input type="checkbox"/> Feather	Seat cushion	<input checked="" type="checkbox"/> Fiber <input checked="" type="checkbox"/> Foam <input type="checkbox"/> Feather/Fiber Mix <input type="checkbox"/> Feather	Back cushion	<input checked="" type="checkbox"/> Fiber <input type="checkbox"/> Foam <input type="checkbox"/> Feather/Fiber Mix <input type="checkbox"/> Feather
	<b>COMFORT</b>	Standard Comfort <input checked="" type="checkbox"/>	Firm Comfort <input type="checkbox"/>				
	<b>FUNCTION</b>	Bed <input checked="" type="checkbox"/>	Electric motion <input type="checkbox"/>	Motion <input type="checkbox"/>	Recliner <input type="checkbox"/>	Sliding <input type="checkbox"/>	
	<b>VISUAL APPEARANCE*</b>	Low <input type="checkbox"/>	Medium <input checked="" type="checkbox"/>	High <input type="checkbox"/>			
	<b>LEGS</b>	Wood <input checked="" type="checkbox"/>	Metal <input type="checkbox"/>	Upholstered <input type="checkbox"/>	Plastic <input type="checkbox"/>	Castors <input type="checkbox"/>	

VISUAL APPEARANCE

The product may reveal various wrinkles due to the combination of Elasticity of the covering, characteristics of the interior construction and the design of the product.



Products with Visual Appearance listed as High or Medium would require higher degree of care, where seats and back cushions may require fluffing and plumping more often than Products with Visual Appearance listed as Low.

BED MECHANISM & MATTRESS

MECHANISM		MATTRESS		
VERSIONS	TYPE	VERSIONS	TYPE	DIMENSIONS
008,022,023	Ready-Bed electro-welded - Double folding	022,023	Polyurethane foam	W L H 140 190 13
027	Ready-Bed electro-welded - Double folding	027	Polyurethane foam	160 190 13

**Ready-Bed electro-welded** The back cushion goes under the bed mechanism.

NOTES

- Available in leather (TG only) or fabric.
- Tight Seat Cushion (the seat cushions of the models are fixed to the frame)
- Tight Back Cushion (the back cushions of the models are fixed to the frame)
- No Leather/Fabric Side (the sectional pieces have the side covered with lining and not leather nor fabric)
- Internal wooden frame.
- Feet will be in a bag inside the package and requires assembling.
- Feet available in wood finishings 09 (Walnut) / 18 (Wengè)

## NOTES

---



■ Vers. 164+664+165



■ Vers. 164+664+165



■ Vers. 170+605+387+171



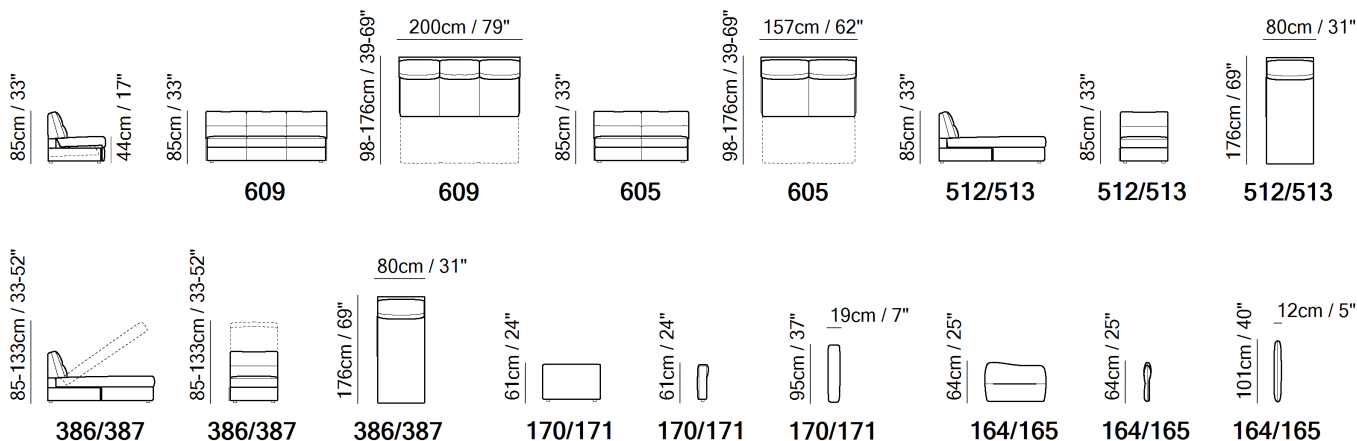

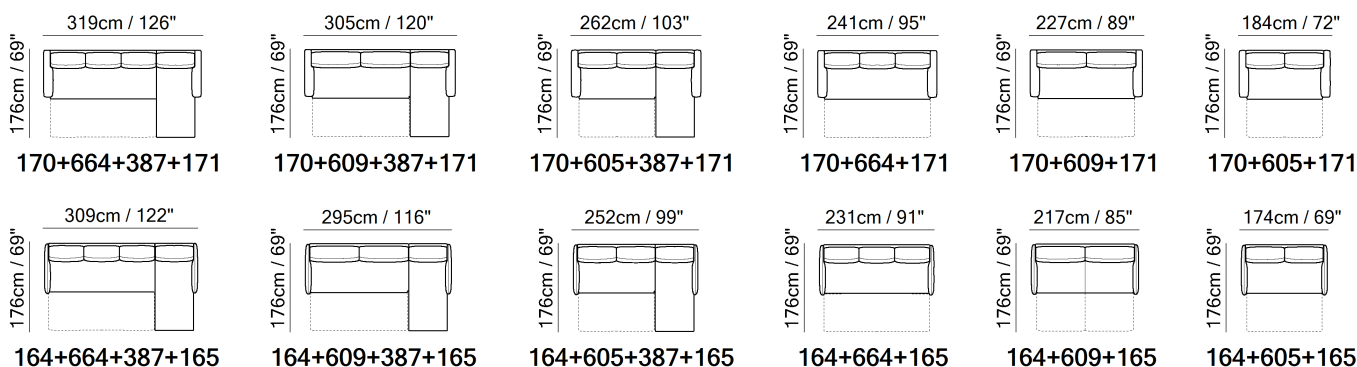

SCHEMATICS



COMPOSITION EXAMPLES



TECHNICAL INFORMATION

	<b>COVERING</b>	Leather <input checked="" type="checkbox"/>	Soft Cover <input checked="" type="checkbox"/>				
	<b>FILLING</b>	Arms	<input type="checkbox"/> Fiber <input checked="" type="checkbox"/> Foam <input type="checkbox"/> Feather/Fiber Mix <input type="checkbox"/> Feather	Seat cushion	<input type="checkbox"/> Fiber <input checked="" type="checkbox"/> Foam <input type="checkbox"/> Feather/Fiber Mix <input type="checkbox"/> Feather	Back cushion	<input type="checkbox"/> Fiber <input checked="" type="checkbox"/> Foam <input type="checkbox"/> Feather/Fiber Mix <input type="checkbox"/> Feather
	<b>COMFORT</b>	Firm Comfort <input type="checkbox"/>	Standard Comfort <input checked="" type="checkbox"/>				
	<b>FUNCTION</b>	Bed <input type="checkbox"/>	Electric motion <input type="checkbox"/>	Motion <input type="checkbox"/>	Recliner <input type="checkbox"/>	Sliding <input checked="" type="checkbox"/>	
	<b>VISUAL APPEARANCE*</b>	Low <input checked="" type="checkbox"/>	Medium <input type="checkbox"/>	High <input type="checkbox"/>			
	<b>LEGS</b>	Metal <input type="checkbox"/>	Wood <input type="checkbox"/>	Castors <input type="checkbox"/>	Plastic <input type="checkbox"/>	Upholstered <input type="checkbox"/>	

VISUAL APPEARANCE

The product may reveal various wrinkles due to the combination of Elasticity of the covering, characteristics of the interior construction and the design of the product.



Products with Visual Appearance listed as High or Medium would require higher degree of care, where seats and back cushions may require fluffing and plumping more often than Products with Visual Appearance listed as Low.

NOTES

- Available in leather (TG only) or fabric.
- **EXTRACTIBLE SEAT MECHANISM:** This model has an extractible seat mechanism, that assisted by dedicated springs, allow you to swiftly pull-out an extra seating. This brings to a perfect leveled surface, that occasionally can make it become a bed. The mechanism feature doesn't require the removal of any seat nor back cushions. The extracted seat has the same comfort as the one provided when in "sofa" mode (with mechanism closed).
- Available with wide and slim arm options
- Packaging: Cardboard wrap.

**NOTES**

---



■ Vers. 009



■ Vers. F50+F38+011+019



■ Vers. F54



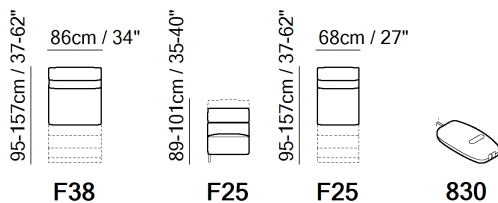
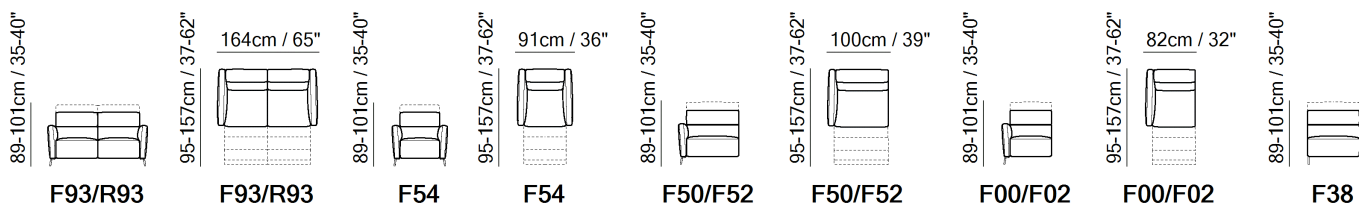
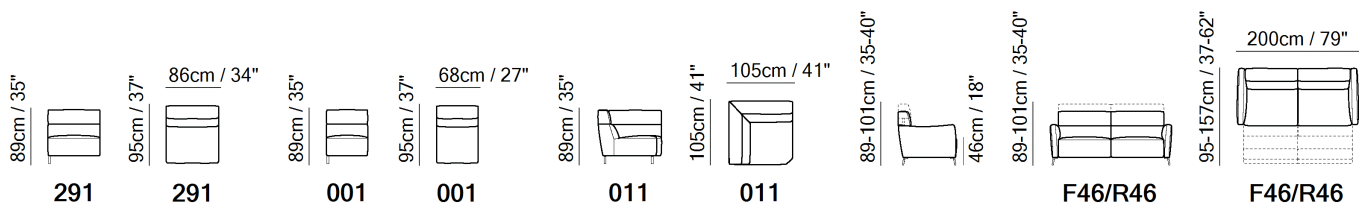
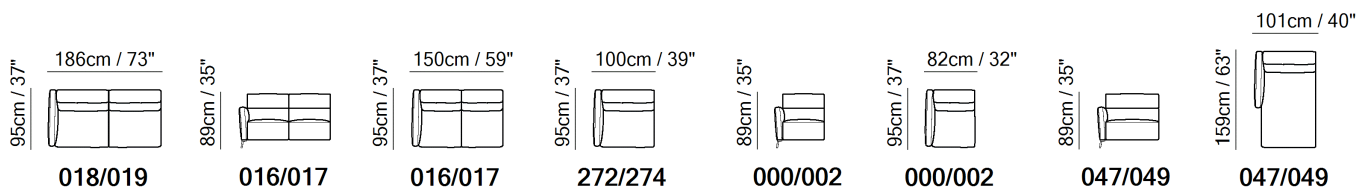
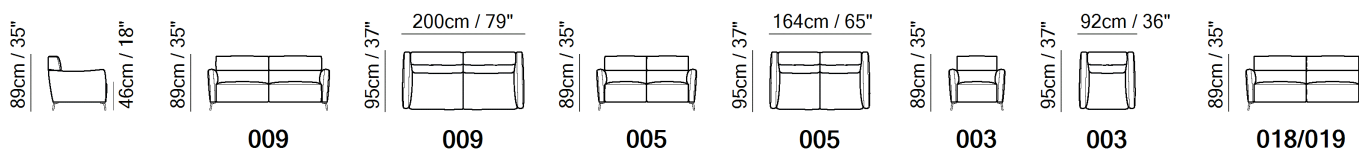

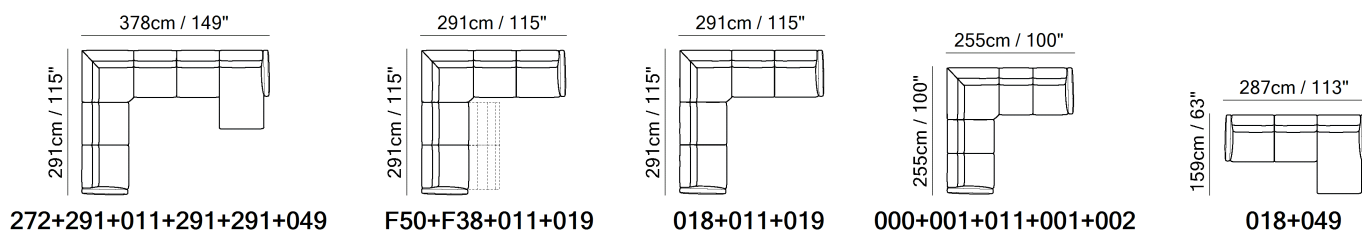

SCHEMATICS



COMPOSITION EXAMPLES



TECHNICAL INFORMATION

	<b>COVERING</b>	Leather <input checked="" type="checkbox"/>	Soft Cover <input checked="" type="checkbox"/>				
	<b>FILLING</b>	Arms	<input type="checkbox"/> Fiber <input checked="" type="checkbox"/> Foam <input type="checkbox"/> Feather/Fiber Mix <input type="checkbox"/> Feather	Seat cushion	<input type="checkbox"/> Fiber <input checked="" type="checkbox"/> Foam <input type="checkbox"/> Feather/Fiber Mix <input type="checkbox"/> Feather	Back cushion	<input type="checkbox"/> Fiber <input checked="" type="checkbox"/> Foam <input type="checkbox"/> Feather/Fiber Mix <input type="checkbox"/> Feather
	<b>COMFORT</b>	Standard Comfort <input checked="" type="checkbox"/>	Firm Comfort <input checked="" type="checkbox"/>				
	<b>FUNCTION</b>	Bed <input type="checkbox"/>	Electric motion <input type="checkbox"/>	Motion <input checked="" type="checkbox"/>	Recliner <input checked="" type="checkbox"/>	Sliding <input type="checkbox"/>	
	<b>VISUAL APPEARANCE*</b>	Low <input checked="" type="checkbox"/>	Medium <input type="checkbox"/>	High <input type="checkbox"/>			
	<b>LEGS</b>	Wood <input type="checkbox"/>	Metal <input type="checkbox"/>	Upholstered <input type="checkbox"/>	Plastic <input type="checkbox"/>	Castors <input type="checkbox"/>	

VISUAL APPEARANCE

The product may reveal various wrinkles due to the combination of Elasticity of the covering, characteristics of the interior construction and the design of the product.



Products with Visual Appearance listed as High or Medium would require higher degree of care, where seats and back cushions may require fluffing and plumping more often than Products with Visual Appearance listed as Low.

NOTES

- Available in leather (TG only) or fabric.
- Dual power mechanism with external switch on the side panel that activates recliner and power headrest lift with manual adjustable tilt position and includes an USB charging port.
- A battery pack can be ordered with its own version code 830. For order entry please use XX for category and XXX for cover code. In order to optimize the duration of the battery, it is suggested to order one per each motion seat.
- Tight Seat Cushion (the seat cushions of the models are fixed to the frame)
- Tight Back Cushion (the back cushions of the models are fixed to the frame)
- Internal wooden frame.
- Feet will be in a bag inside the package and requires assembling.
- Packaging: Cardboard wrap.

NOTES

---



■ Vers. 155



■ Vers. 009



■ Vers. 272+076+291+F52



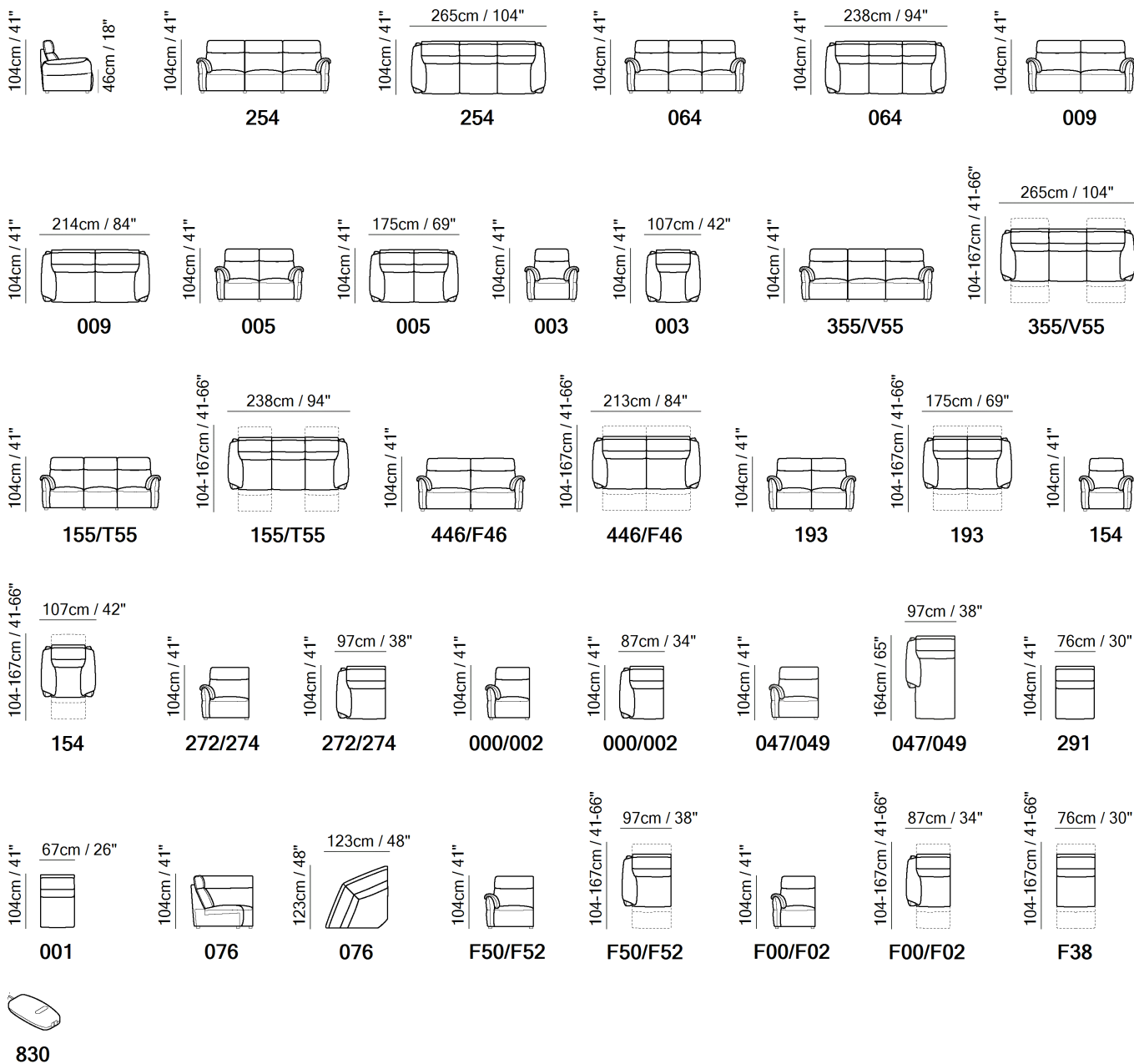

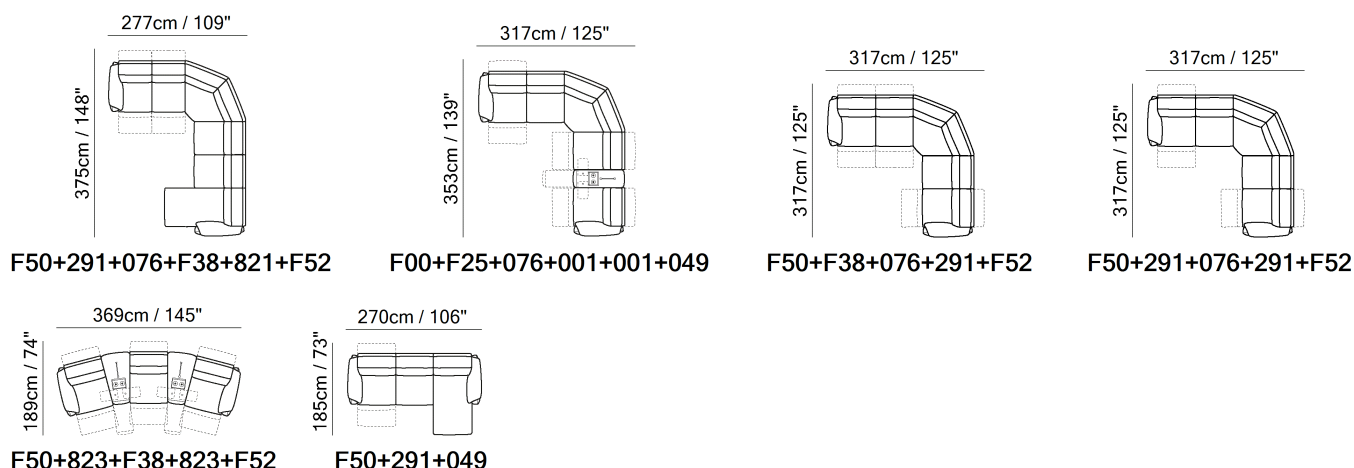

SCHEMATICS



COMPOSITION EXAMPLES



TECHNICAL INFORMATION

	<b>COVERING</b>	Leather <input checked="" type="checkbox"/>	Soft Cover <input checked="" type="checkbox"/>		
	<b>FILLING</b>	Arms	<input type="checkbox"/> Fiber <input checked="" type="checkbox"/> Foam <input type="checkbox"/> Feather/Fiber Mix <input type="checkbox"/> Feather	Seat cushion	<input type="checkbox"/> Fiber <input checked="" type="checkbox"/> Foam <input type="checkbox"/> Feather/Fiber Mix <input type="checkbox"/> Feather
				Back cushion	<input type="checkbox"/> Fiber <input checked="" type="checkbox"/> Foam <input type="checkbox"/> Feather/Fiber Mix <input type="checkbox"/> Feather
	<b>COMFORT</b>	Firm Comfort <input checked="" type="checkbox"/>	Standard Comfort <input checked="" type="checkbox"/>		
	<b>FUNCTION</b>	Bed <input type="checkbox"/>	Electric motion <input checked="" type="checkbox"/>	Motion <input checked="" type="checkbox"/>	Recliner <input checked="" type="checkbox"/>
					Sliding <input type="checkbox"/>
	<b>VISUAL APPEARANCE*</b>	Low <input type="checkbox"/>	Medium <input checked="" type="checkbox"/>	High <input type="checkbox"/>	
	<b>LEGS</b>	Metal <input type="checkbox"/>	Wood <input type="checkbox"/>	Castors <input type="checkbox"/>	Plastic <input type="checkbox"/>
					Upholstered <input type="checkbox"/>

VISUAL APPEARANCE

The product may reveal various wrinkles due to the combination of Elasticity of the covering, characteristics of the interior construction and the design of the product.



Products with Visual Appearance listed as High or Medium would require higher degree of care, where seats and back cushions may require fluffing and plumping more often than Products with Visual Appearance listed as Low.

NOTES

- Available in leather or fabric.
- Ergocert Certified. Human-Centered Design certification by Ergocert, is the first European ergonomics certification body. This certification guarantees that the entire design and production process has been completed by listening to the needs of the end user to create and offer an effective and unique comfort experience.
- The multifunctional console, with a full wooden finish, features a spacious tabletop, a storage drawer, a built-in USB port, and connectors for adding optional features—blending style, convenience, and versatility. The console can be ordered with its own version code 821 or 823. For order entry please use XXX for alias code and finishing code ST49 ash brown or ST50 ash blonde.
- By distributing weight evenly across all pressure points, the zero-gravity power motion system makes you feel weightless. It takes the pressure off your spine and can promote circulation in the legs.  
The definition of Zero Gravity Reclining is the ability for your heart to be resting above your feet which provides proven health benefits.
- ZERO GRAVITY™ DUAL POWER MOTION: a unique power motion system that separately and independently activates the different functions, to adjust the seat recliner and the headrest, allowing you to reach extreme comfort in a “zero gravity” position.
- Switch #1: All in One Power Reclining mechanism that simultaneously reclines the back, activates a “comfort tilt” of the seat and a full extension of the footrest, taking you to a “zero gravity” position that will make you experience a total and unparalleled relaxation.

## NOTES

---

- Switch #2: Power Adjustable Headrest which allows you to recline the headrest forward with millimetric precision to support you with a perfect and proper posture.
- Functions are operated by the power switch located on outside panel of the arm which also allocates a USB charging port.
- Second option versions (355/V55/254) with three seats and three cushions have a wider seating vs standard versions (155/T55/064) resulting in a bigger configuration (265 cm/106" vs 238 cm/95,2")
- **PACKAGING & DELIVERY**  
This model has been designed in an innovative way to facilitate the delivery to the final consumer throughout separate packages that have sizes and weight that are easy to handle.
- In fact, on the 3-seater power motion sofa you will have a choice of preferred packaging:
  - > Versions T55, V55 and F46 follow the above redesigned packing with 3 separate boxes (Arms / Seat and Base / Backrest) to maximize space in container as well as to facilitate the handling to final consumer.
  - > Versions 155, 355 and 446 are packaged in 1 single box, that can facilitate warehouse management



■ Vers. F46



■ Vers. F46



■ Vers. F00+001+F02



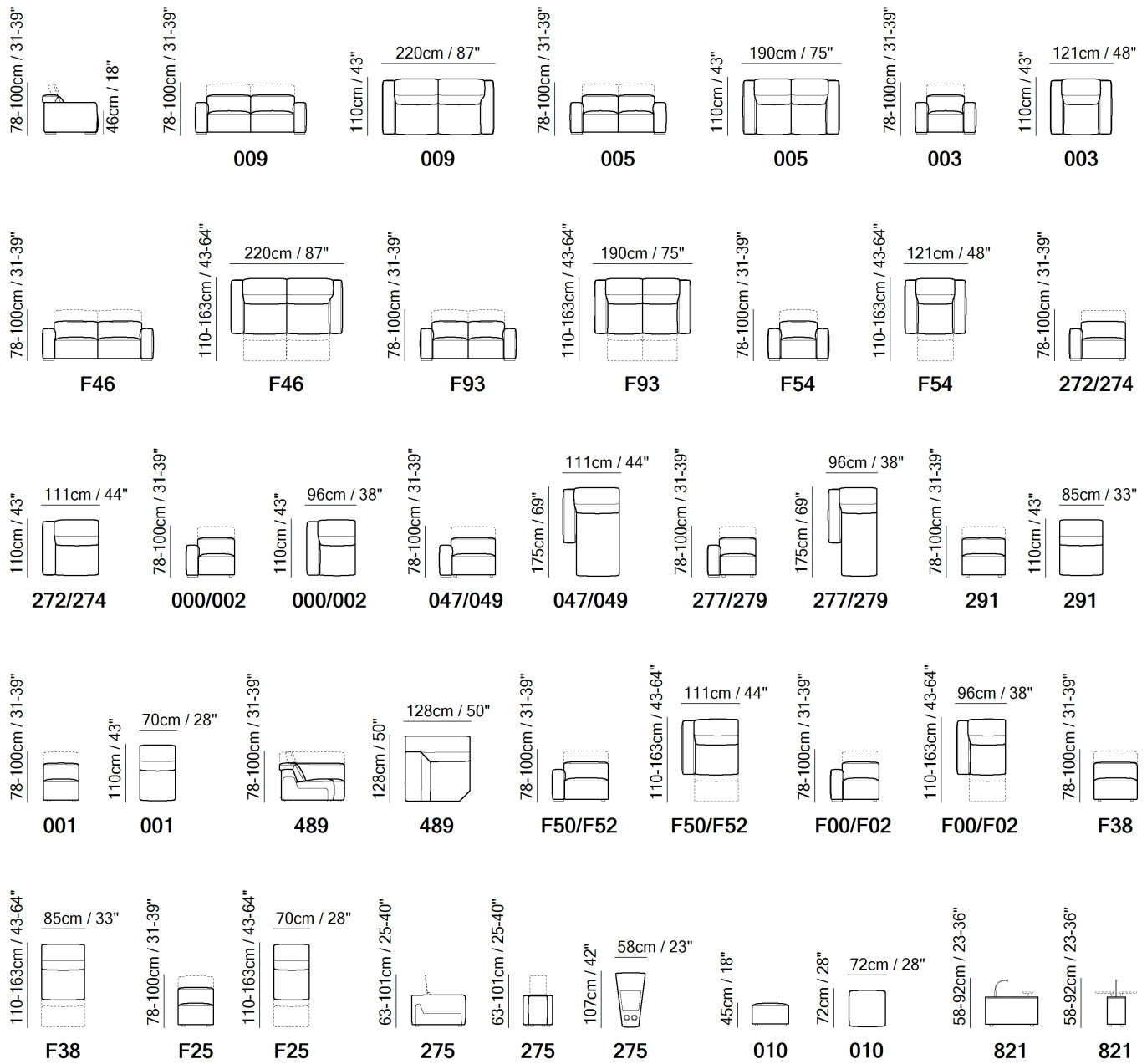

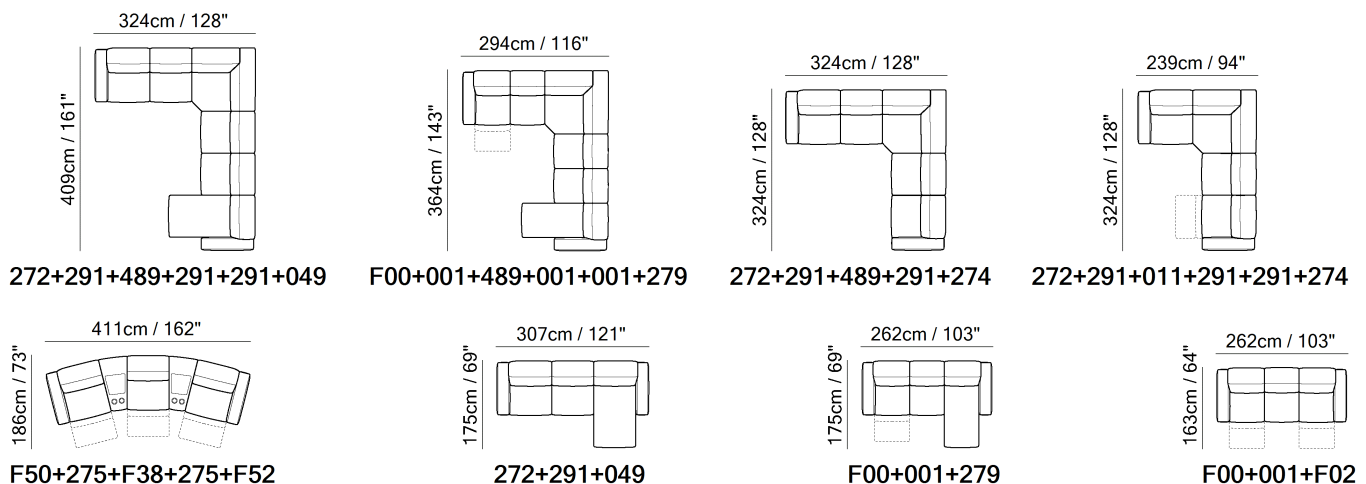

SCHEMATICS



COMPOSITION EXAMPLES



TECHNICAL INFORMATION

	<b>COVERING</b>	Leather <input checked="" type="checkbox"/>	Soft Cover <input checked="" type="checkbox"/>			
	<b>FILLING</b>	Arms <input type="checkbox"/> Fiber <input checked="" type="checkbox"/> Foam <input type="checkbox"/> Feather/Fiber Mix <input type="checkbox"/> Feather	Seat cushion <input type="checkbox"/> Fiber <input checked="" type="checkbox"/> Foam <input type="checkbox"/> Feather/Fiber Mix <input type="checkbox"/> Feather	Back cushion <input type="checkbox"/> Fiber <input checked="" type="checkbox"/> Foam <input type="checkbox"/> Feather/Fiber Mix <input type="checkbox"/> Feather		
	<b>COMFORT</b>	Standard Comfort <input checked="" type="checkbox"/>	Firm Comfort <input checked="" type="checkbox"/>			
	<b>FUNCTION</b>	Bed <input type="checkbox"/>	Electric motion <input type="checkbox"/>	Motion <input checked="" type="checkbox"/>	Recliner <input checked="" type="checkbox"/>	Sliding <input type="checkbox"/>
	<b>VISUAL APPEARANCE*</b>	Low <input type="checkbox"/>	Medium <input checked="" type="checkbox"/>	High <input type="checkbox"/>		
	<b>LEGS</b>	Wood <input checked="" type="checkbox"/>	Metal <input type="checkbox"/>	Upholstered <input type="checkbox"/>	Plastic <input type="checkbox"/>	Castors <input type="checkbox"/>

VISUAL APPEARANCE

The product may reveal various wrinkles due to the combination of Elasticity of the covering, characteristics of the interior construction and the design of the product.



Products with Visual Appearance listed as High or Medium would require higher degree of care, where seats and back cushions may require fluffing and plumping more often than Products with Visual Appearance listed as Low.

NOTES

- Available in leather (TG only) or fabric.
- Dual power motion recliner: headrest and footrest
- The multifunctional console, with a full wooden finish, features a spacious tabletop, a storage drawer, a built-in USB port, and connectors for adding optional features—blending style, convenience, and versatility. The console can be ordered with its own version code 821 or 823. For order entry please use XXX for alias code and finishing code ST49 ash brown or ST50 ash blonde.
- Functions are operated by the power switch located on outside panel of the arm which also allocates a USB charging port.
- The armless relax seats have an upholstered switch flap on the side that can be easily hidden between the seats to activate the mechanism.
- The switch for version chair without arms with mechanism (versions 338/F38/F25), is on the left hand side of the seat (front view)
- A battery pack can be ordered with its own version code 830. For order entry please use XX for category and XXX for cover code. In order to optimize the duration of the battery, it is suggested to order one per each motion seat.
- Packaging: plastic wrap for stationary versions and cardboard box for motion/sofabed versions
- Feet available in wood finishings 09 (Walnut) / 18 (Wengè)

NOTES

---



■ Vers. 225+281+010+489+100



■ Vers. 225+281+010+312+223



■ Vers. 010+312+312



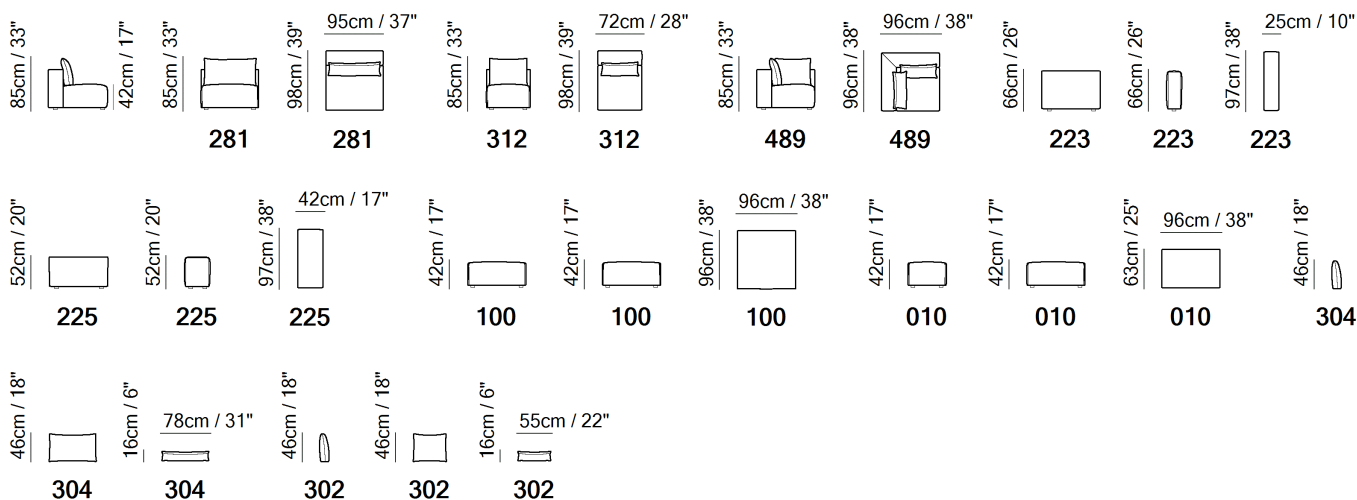

SCHEMATICS

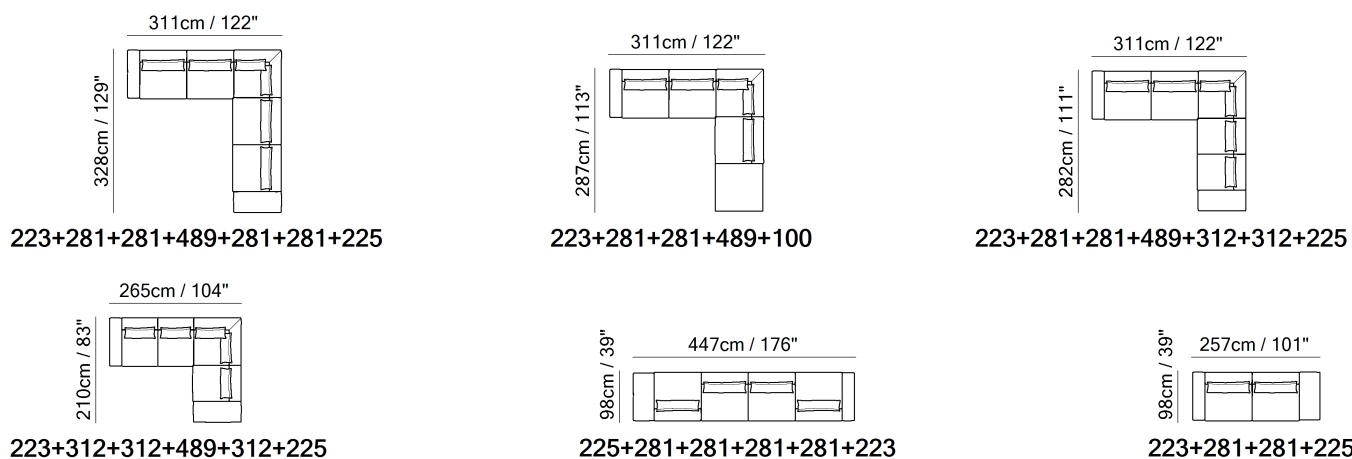

COMPOSITION EXAMPLES



TECHNICAL INFORMATION

	<b>COVERING</b>	Leather <input checked="" type="checkbox"/>	Soft Cover <input checked="" type="checkbox"/>				
	<b>FILLING</b>	Arms	<input type="checkbox"/> Fiber <input checked="" type="checkbox"/> Foam <input type="checkbox"/> Feather/Fiber Mix <input type="checkbox"/> Feather	Seat cushion	<input type="checkbox"/> Fiber <input checked="" type="checkbox"/> Foam <input type="checkbox"/> Feather/Fiber Mix <input type="checkbox"/> Feather	Back cushion	<input type="checkbox"/> Fiber <input checked="" type="checkbox"/> Foam <input type="checkbox"/> Feather/Fiber Mix <input type="checkbox"/> Feather
	<b>COMFORT</b>	Firm Comfort <input type="checkbox"/>	Standard Comfort <input checked="" type="checkbox"/>				
	<b>FUNCTION</b>	Bed <input type="checkbox"/>	Electric motion <input type="checkbox"/>	Motion <input type="checkbox"/>	Recliner <input type="checkbox"/>	Sliding <input type="checkbox"/>	
	<b>LEGS</b>	Metal <input type="checkbox"/>	Wood <input type="checkbox"/>	Castors <input type="checkbox"/>	Plastic <input type="checkbox"/>	Upholstered <input type="checkbox"/>	

NOTES

- To allow modularity, the single elements can be put together thanks to the rubber stops under the legs.
- Model Puzzle with its two size module seats (versione 312 or 281) is particularly suitable for "reverse seating" sectional configurations. Seat versions (312, 281) and corner (489) come with loose back cushions in same cover as the rest of the element (the loose back cushion is not orderable separately).
- 2 arms with different dimensions (233 with slim/high arm or vers 225 with large/low arm). The single arm can be used both on left or right side of your sectional throughout a universal connector.
- 2 size ottomans (versions 010 or 100) that can both be used as a terminal element or in the middle of the seats of your sectional.

NOTES

---



■ Vers. N46



■ Vers. N46



■ Vers. 272+291+189



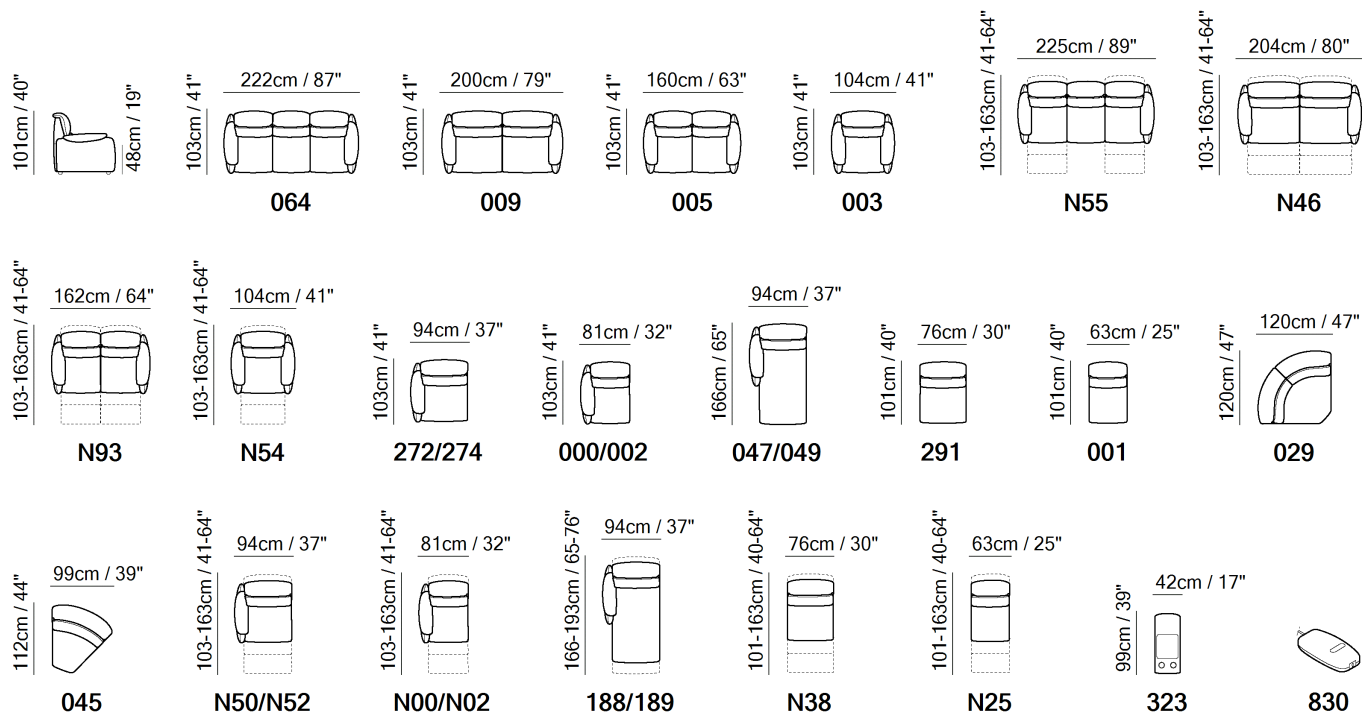

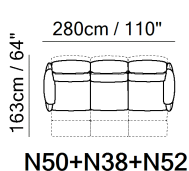
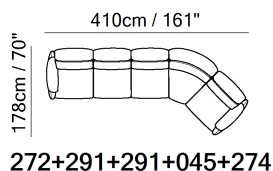
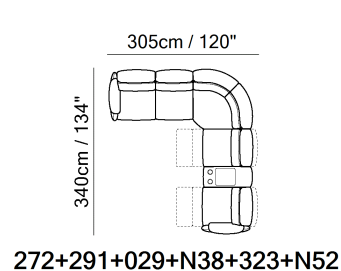
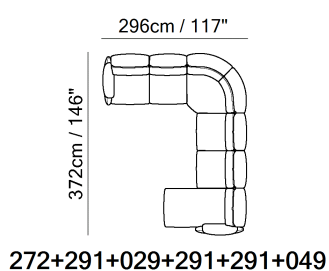
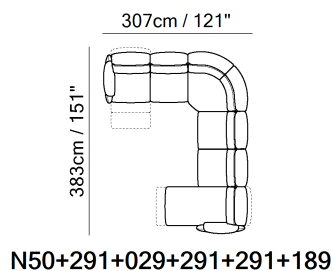

SCHEMATICS



COMPOSITION EXAMPLES



TECHNICAL INFORMATION

	<b>COVERING</b>	Leather <input checked="" type="checkbox"/>	Soft Cover <input checked="" type="checkbox"/>			
	<b>FILLING</b>	Arms <input type="checkbox"/> Fiber <input checked="" type="checkbox"/> Foam <input type="checkbox"/> Feather/Fiber Mix <input type="checkbox"/> Feather	Seat cushion <input type="checkbox"/> Fiber <input checked="" type="checkbox"/> Foam <input type="checkbox"/> Feather/Fiber Mix <input type="checkbox"/> Feather	Back cushion <input type="checkbox"/> Fiber <input checked="" type="checkbox"/> Foam <input type="checkbox"/> Feather/Fiber Mix <input type="checkbox"/> Feather		
	<b>COMFORT</b>	Standard Comfort <input checked="" type="checkbox"/>	Firm Comfort <input checked="" type="checkbox"/>			
	<b>FUNCTION</b>	Bed <input type="checkbox"/>	Electric motion <input checked="" type="checkbox"/>	Motion <input checked="" type="checkbox"/>	Recliner <input checked="" type="checkbox"/>	Sliding <input type="checkbox"/>
	<b>VISUAL APPEARANCE*</b>	Low <input checked="" type="checkbox"/>	Medium <input type="checkbox"/>	High <input type="checkbox"/>		
	<b>LEGS</b>	Wood <input type="checkbox"/>	Metal <input type="checkbox"/>	Upholstered <input type="checkbox"/>	Plastic <input type="checkbox"/>	Castors <input type="checkbox"/>

VISUAL APPEARANCE

The product may reveal various wrinkles due to the combination of Elasticity of the covering, characteristics of the interior construction and the design of the product.



Products with Visual Appearance listed as High or Medium would require higher degree of care, where seats and back cushions may require fluffing and plumping more often than Products with Visual Appearance listed as Low.

NOTES

- Available in leather (TG only) or fabric.
- FABRIC: In fabric contrast welt (or any another decorative detail such as a band under arm cushion) can be made either in same category fabric or in leather with any color of Le Mans (only).
- CUBICOMFORT™ Triple-Motion Technology is a registered trademark. It denotes a set of independent motion systems that activate the various elements of the sofa (seat, backrest, headrest and footrest) allowing each person to adjust their position of absolute comfort to the millimeter.
- Mech. 1: All in One Power Reclining mechanism simultaneously reclines the back and seat and footrest that allows you to reach a horizontal position for unlimited relaxation.
- Mech. 2: Power Lumbar Support allows you to adjust the lower part of the backrest by increasing or decreasing the pressure for a better back support.
- Mech. 3: Power Adjustable Headrest which allows you to recline the headrest forward with millimetric precision and reach a perfect relaxation position for great comfort.
- Equipped with satin label that is intended to indicate the position of the control panel.
- Functions are operated by a three-button power switch located hidden on the seat cushion side.
- A battery pack can be ordered with its own version code 830. For order entry please use XX for category and XXX for cover code. In order to optimize the duration of the battery, it is suggested to order one per each motion seat.

**NOTES**

---



■ Vers. 286+481



■ Vers. 480+017



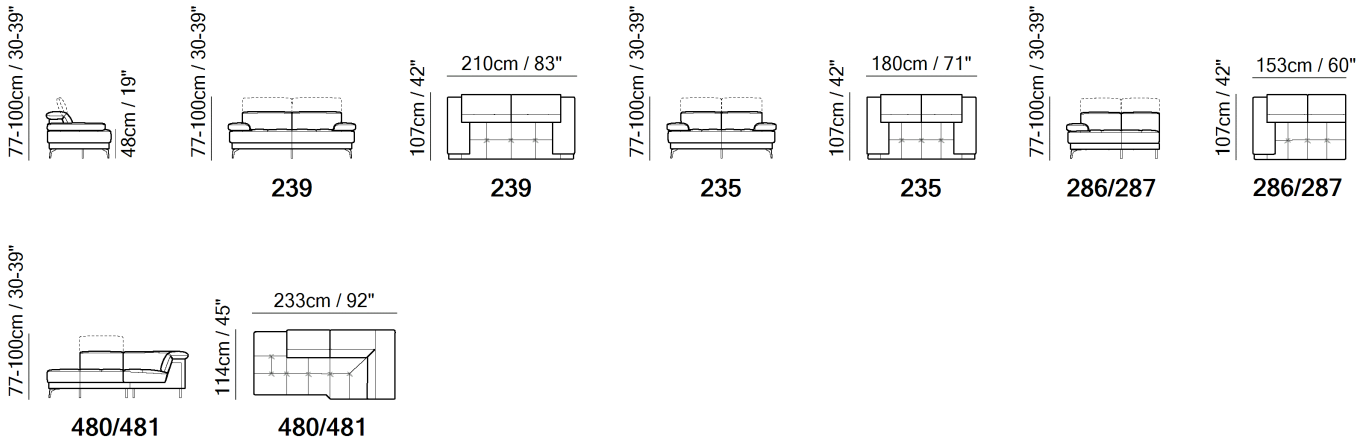

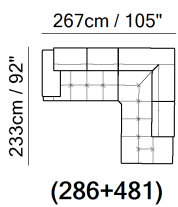

**SCHEMATICS**



**COMPOSITION EXAMPLES**



TECHNICAL INFORMATION

	<b>COVERING</b>	Leather <input checked="" type="checkbox"/>	Soft Cover <input checked="" type="checkbox"/>				
	<b>FILLING</b>	Arms	<input type="checkbox"/> Fiber <input checked="" type="checkbox"/> Foam <input type="checkbox"/> Feather/Fiber Mix <input type="checkbox"/> Feather	Seat cushion	<input type="checkbox"/> Fiber <input checked="" type="checkbox"/> Foam <input type="checkbox"/> Feather/Fiber Mix <input type="checkbox"/> Feather	Back cushion	<input type="checkbox"/> Fiber <input checked="" type="checkbox"/> Foam <input type="checkbox"/> Feather/Fiber Mix <input type="checkbox"/> Feather
	<b>COMFORT</b>	Firm Comfort <input checked="" type="checkbox"/>	Standard Comfort <input checked="" type="checkbox"/>				
	<b>FUNCTION</b>	Bed <input type="checkbox"/>	Electric motion <input type="checkbox"/>	Motion <input type="checkbox"/>	Recliner <input type="checkbox"/>	Sliding <input type="checkbox"/>	
	<b>VISUAL APPEARANCE*</b>	Low <input checked="" type="checkbox"/>	Medium <input type="checkbox"/>	High <input type="checkbox"/>			
	<b>LEGS</b>	Metal <input checked="" type="checkbox"/>	Wood <input type="checkbox"/>	Castors <input type="checkbox"/>	Plastic <input type="checkbox"/>	Upholstered <input type="checkbox"/>	

VISUAL APPEARANCE

The product may reveal various wrinkles due to the combination of Elasticity of the covering, characteristics of the interior construction and the design of the product.



Products with Visual Appearance listed as High or Medium would require higher degree of care, where seats and back cushions may require fluffing and plumping more often than Products with Visual Appearance listed as Low.

NOTES

- Available in leather (TG only) or fabric.
- The model has manual adjustable headrest.
- On the terminal versions (480/481), the model has a fixed headrest
- Feet will be in a bag inside the package and requires assembling.
- The model will be wrapped in a plastic bag.
- Feet available in metal finishings 77 (Glossy Chromed) / 79 (Matte Black)
- Feet height 15,5 cm

NOTES

---



■ Vers. 009



■ Vers. 016+201



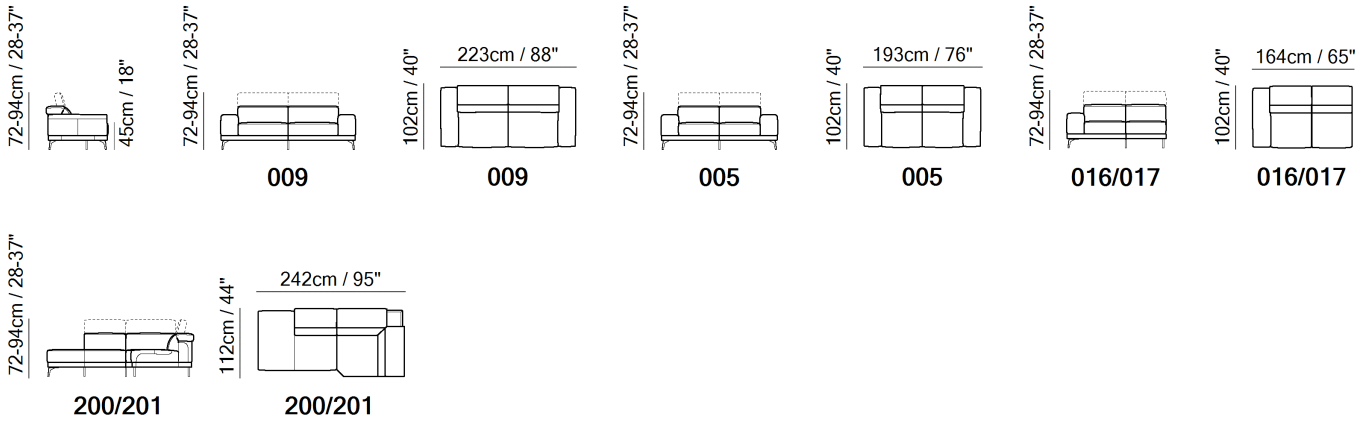

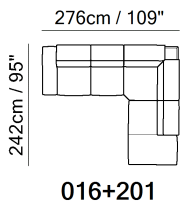

SCHEMATICS



COMPOSITION EXAMPLES



TECHNICAL INFORMATION

	<b>COVERING</b>	Leather <input checked="" type="checkbox"/>	Soft Cover <input checked="" type="checkbox"/>				
	<b>FILLING</b>	Arms	<input type="checkbox"/> Fiber <input checked="" type="checkbox"/> Foam <input type="checkbox"/> Feather/Fiber Mix <input type="checkbox"/> Feather	Seat cushion	<input type="checkbox"/> Fiber <input checked="" type="checkbox"/> Foam <input type="checkbox"/> Feather/Fiber Mix <input type="checkbox"/> Feather	Back cushion	<input type="checkbox"/> Fiber <input checked="" type="checkbox"/> Foam <input type="checkbox"/> Feather/Fiber Mix <input type="checkbox"/> Feather
	<b>COMFORT</b>	Standard Comfort <input checked="" type="checkbox"/>	Firm Comfort <input checked="" type="checkbox"/>				
	<b>FUNCTION</b>	Bed <input type="checkbox"/>	Electric motion <input type="checkbox"/>	Motion <input type="checkbox"/>	Recliner <input type="checkbox"/>	Sliding <input type="checkbox"/>	
	<b>VISUAL APPEARANCE*</b>	Low <input checked="" type="checkbox"/>	Medium <input type="checkbox"/>	High <input type="checkbox"/>			
	<b>LEGS</b>	Wood <input type="checkbox"/>	Metal <input checked="" type="checkbox"/>	Upholstered <input type="checkbox"/>	Plastic <input type="checkbox"/>	Castors <input type="checkbox"/>	

VISUAL APPEARANCE

The product may reveal various wrinkles due to the combination of Elasticity of the covering, characteristics of the interior construction and the design of the product.



Products with Visual Appearance listed as High or Medium would require higher degree of care, where seats and back cushions may require fluffing and plumping more often than Products with Visual Appearance listed as Low.

NOTES

- Available in leather (TG only) or fabric.
- Adjustable headrest on all versions.
- Feet will be in a bag inside the package and requires assembling.
- The model will be wrapped in a plastic bag.
- Feet available in metal finishings 77 (Glossy Chromed) / 79 (Matte Black)
- Feet height 15,5 cm

NOTES

---



■ Vers. T66



■ Vers. T66



■ Vers. 182+481



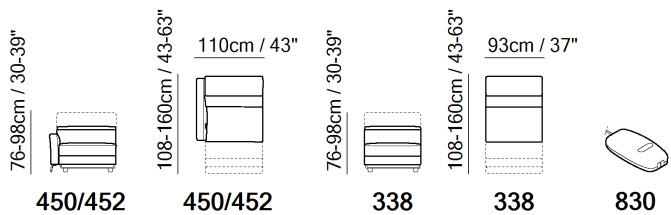
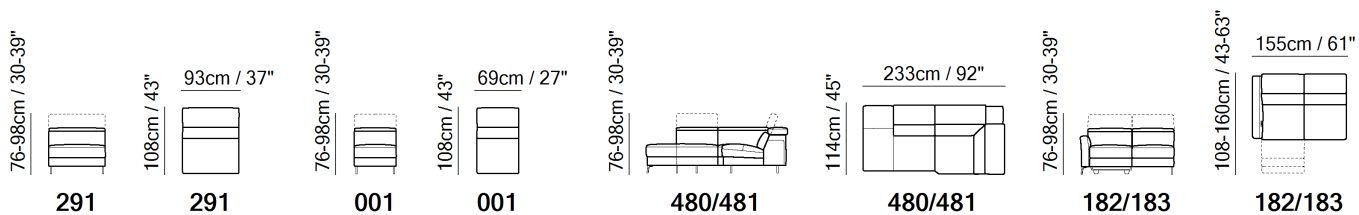
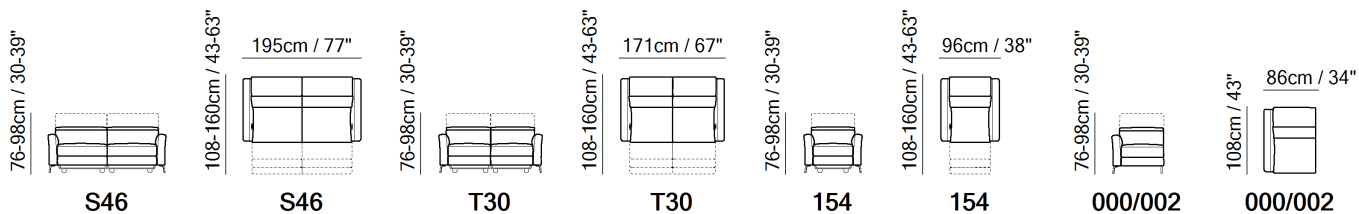
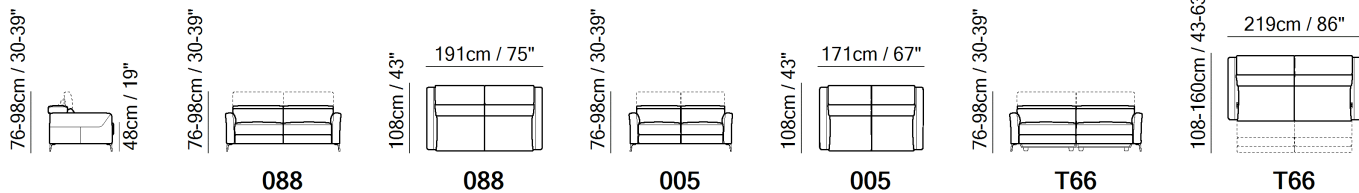

SCHEMATICS

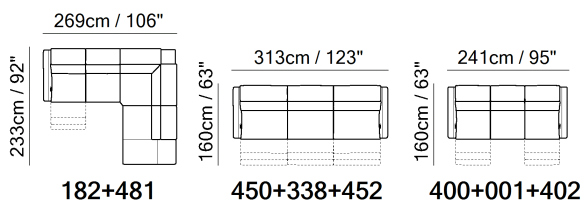

COMPOSITION EXAMPLES



TECHNICAL INFORMATION

	<b>COVERING</b>	Leather <input checked="" type="checkbox"/>	Soft Cover <input checked="" type="checkbox"/>				
	<b>FILLING</b>	Arms	<input type="checkbox"/> Fiber <input checked="" type="checkbox"/> Foam <input type="checkbox"/> Feather/Fiber Mix <input type="checkbox"/> Feather	Seat cushion	<input type="checkbox"/> Fiber <input checked="" type="checkbox"/> Foam <input type="checkbox"/> Feather/Fiber Mix <input type="checkbox"/> Feather	Back cushion	<input type="checkbox"/> Fiber <input checked="" type="checkbox"/> Foam <input type="checkbox"/> Feather/Fiber Mix <input type="checkbox"/> Feather
	<b>COMFORT</b>	Firm Comfort <input checked="" type="checkbox"/>	Standard Comfort <input checked="" type="checkbox"/>				
	<b>FUNCTION</b>	Bed <input type="checkbox"/>	Electric motion <input checked="" type="checkbox"/>	Motion <input checked="" type="checkbox"/>	Recliner <input checked="" type="checkbox"/>	Sliding <input type="checkbox"/>	
	<b>VISUAL APPEARANCE*</b>	Low <input checked="" type="checkbox"/>	Medium <input type="checkbox"/>	High <input type="checkbox"/>			
	<b>LEGS</b>	Metal <input checked="" type="checkbox"/>	Wood <input type="checkbox"/>	Castors <input type="checkbox"/>	Plastic <input type="checkbox"/>	Upholstered <input type="checkbox"/>	

VISUAL APPEARANCE

The product may reveal various wrinkles due to the combination of Elasticity of the covering, characteristics of the interior construction and the design of the product.



Products with Visual Appearance listed as High or Medium would require higher degree of care, where seats and back cushions may require fluffing and plumping more often than Products with Visual Appearance listed as Low.

NOTES

- Available in leather (TG only) or fabric.
- SINGLE POWER MOTION: Power mechanism that activates a smooth system reclining seat, backrest and footrest for maximum relaxation
- Power function are operated throughout an easily accessible switch located on the inner part of the arm.
- Adjustable headrest on all versions.
- Feet available in metal finishing 79 (Matte Black)

NOTES

---



■ Vers. 480+019



■ Vers. 000+017



■ Vers. Z386+031



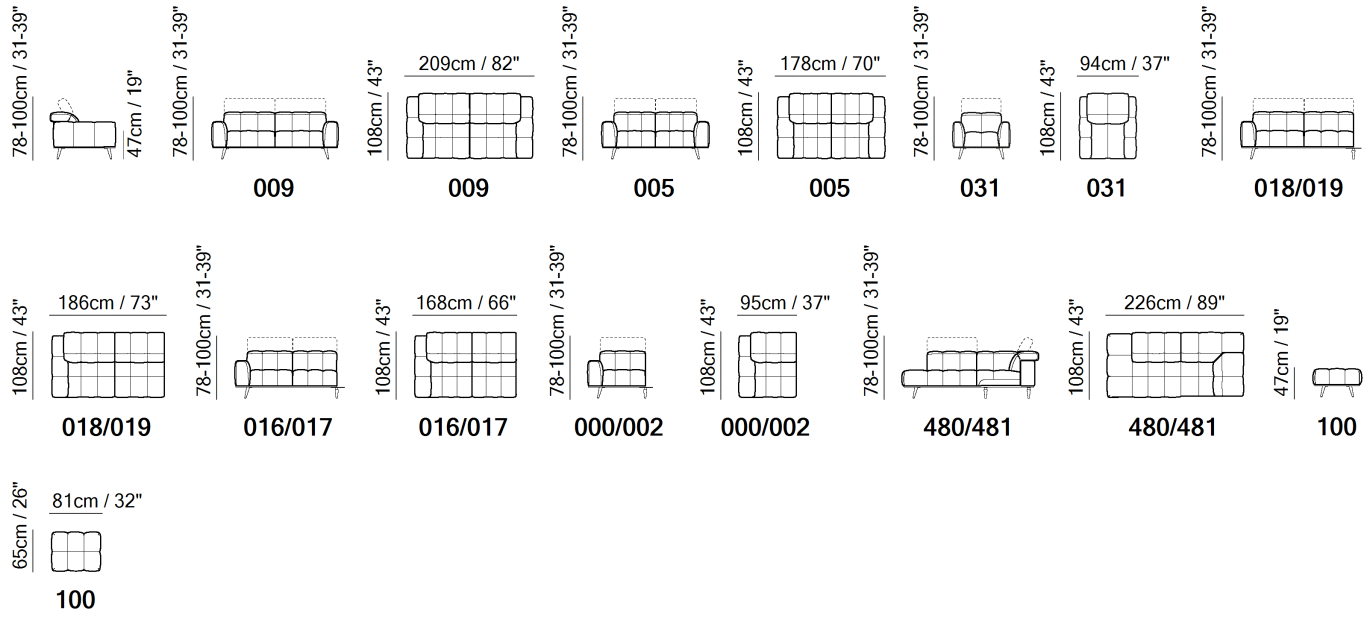

SCHEMATICS

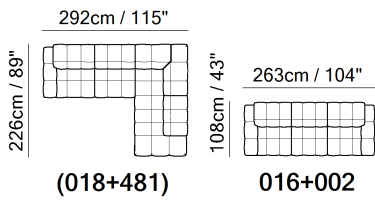

COMPOSITION EXAMPLES



TECHNICAL INFORMATION

	<b>COVERING</b>	Leather <input checked="" type="checkbox"/>	Soft Cover <input checked="" type="checkbox"/>				
	<b>FILLING</b>	Arms	<input type="checkbox"/> Fiber <input checked="" type="checkbox"/> Foam <input type="checkbox"/> Feather/Fiber Mix <input type="checkbox"/> Feather	Seat cushion	<input type="checkbox"/> Fiber <input checked="" type="checkbox"/> Foam <input type="checkbox"/> Feather/Fiber Mix <input type="checkbox"/> Feather	Back cushion	<input type="checkbox"/> Fiber <input checked="" type="checkbox"/> Foam <input type="checkbox"/> Feather/Fiber Mix <input type="checkbox"/> Feather
	<b>COMFORT</b>	Standard Comfort <input checked="" type="checkbox"/>	Firm Comfort <input checked="" type="checkbox"/>				
	<b>FUNCTION</b>	Bed <input type="checkbox"/>	Electric motion <input type="checkbox"/>	Motion <input type="checkbox"/>	Recliner <input type="checkbox"/>	Sliding <input type="checkbox"/>	
	<b>LEGS</b>	Wood <input type="checkbox"/>	Metal <input checked="" type="checkbox"/>	Upholstered <input type="checkbox"/>	Plastic <input type="checkbox"/>	Castors <input type="checkbox"/>	

NOTES

- Available in leather (TG only) or fabric.
- The model has manual adjustable headrest.
- On the terminal versions (480/481), the model has a fixed headrest
- The model will be wrapped in a plastic bag.
- Feet are always made of metal, the wooden effect is obtained by water transfer print.
- Feet height 15,0 cm

NOTES

---



■ Vers. 735



■ Vers. 735



■ Vers. 516+429



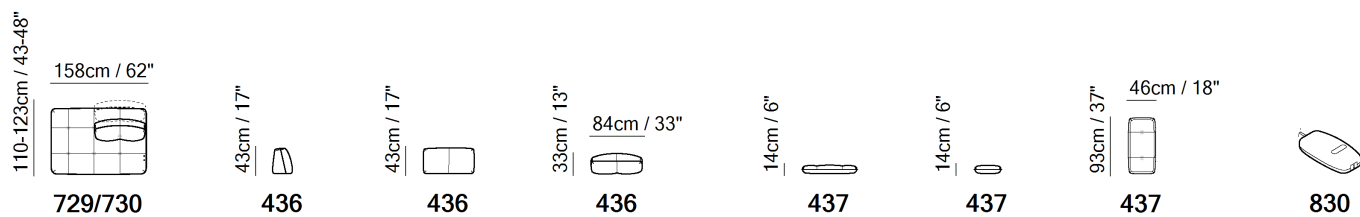
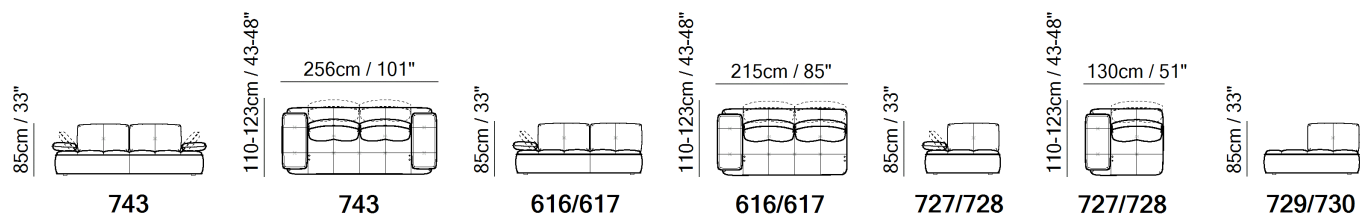
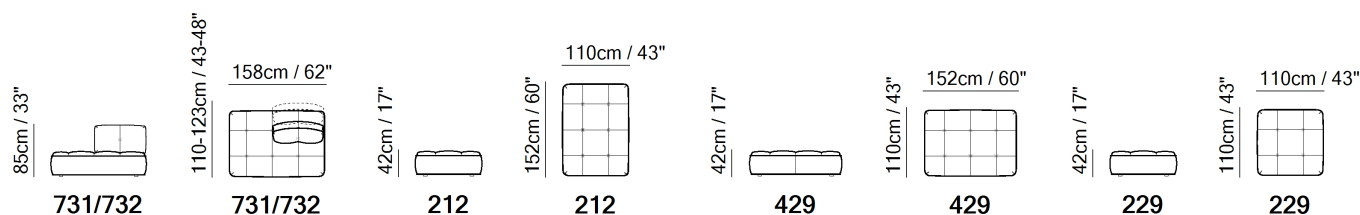
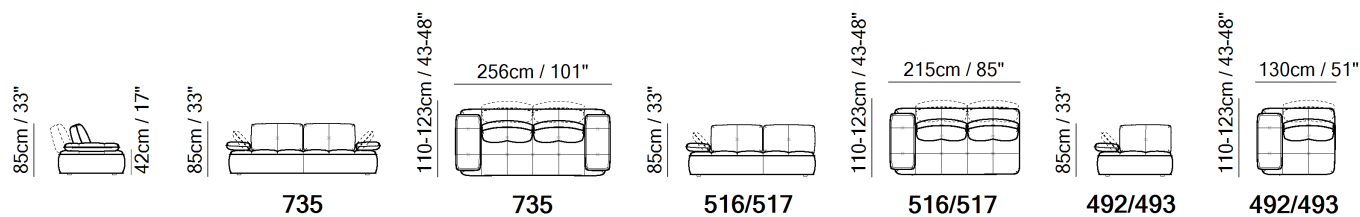

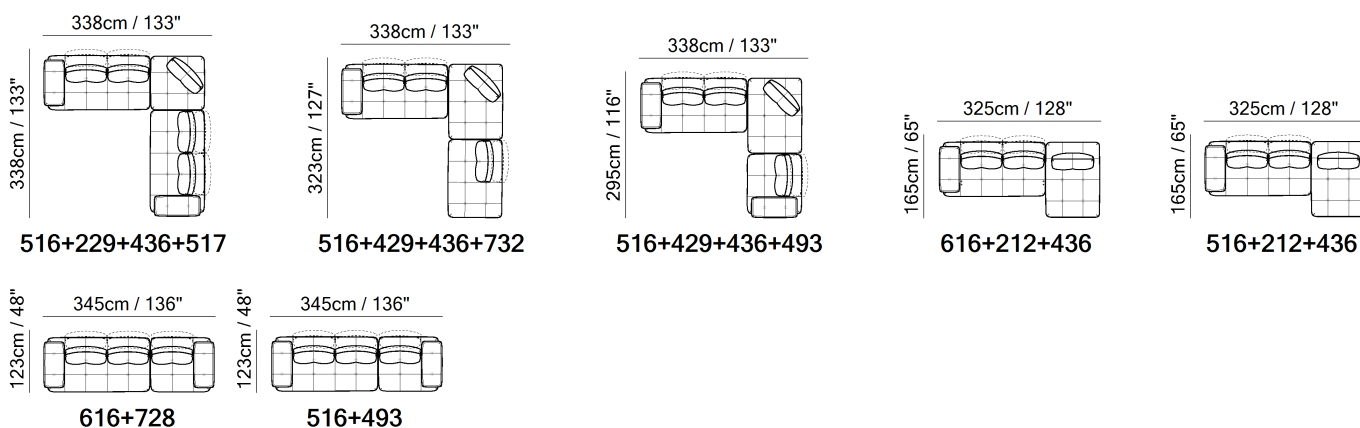

SCHEMATICS



COMPOSITION EXAMPLES



TECHNICAL INFORMATION

	<b>COVERING</b>	Leather <input checked="" type="checkbox"/>	Soft Cover <input checked="" type="checkbox"/>				
	<b>FILLING</b>	Arms	<input type="checkbox"/> Fiber <input checked="" type="checkbox"/> Foam <input type="checkbox"/> Feather/Fiber Mix <input type="checkbox"/> Feather	Seat cushion	<input type="checkbox"/> Fiber <input checked="" type="checkbox"/> Foam <input type="checkbox"/> Feather/Fiber Mix <input type="checkbox"/> Feather	Back cushion	<input type="checkbox"/> Fiber <input checked="" type="checkbox"/> Foam <input type="checkbox"/> Feather/Fiber Mix <input type="checkbox"/> Feather
	<b>COMFORT</b>	Firm Comfort <input checked="" type="checkbox"/>	Standard Comfort <input checked="" type="checkbox"/>				
	<b>FUNCTION</b>	Bed <input type="checkbox"/>	Electric motion <input checked="" type="checkbox"/>	Motion <input type="checkbox"/>	Recliner <input type="checkbox"/>	Sliding <input checked="" type="checkbox"/>	
	<b>VISUAL APPEARANCE*</b>	Low <input type="checkbox"/>	Medium <input type="checkbox"/>	High <input checked="" type="checkbox"/>			
	<b>LEGS</b>	Metal <input type="checkbox"/>	Wood <input type="checkbox"/>	Castors <input type="checkbox"/>	Plastic <input type="checkbox"/>	Upholstered <input type="checkbox"/>	

VISUAL APPEARANCE

The product may reveal various wrinkles due to the combination of Elasticity of the covering, characteristics of the interior construction and the design of the product.



Products with Visual Appearance listed as High or Medium would require higher degree of care, where seats and back cushions may require fluffing and plumping more often than Products with Visual Appearance listed as Low.

NOTES

- Available in leather (TG only) or fabric.
- Pixel is an extremely versatile and innovative model where you can unleash your creativity in choosing different combinations of coverings between leather and fabric.
- Available in leather and fabric with optional contrast piping.  
To be ordered with 2 coverings:
  - 1st Covering = Sofa/Bed
  - 2nd Covering = Piping
- When in leather (3 combo possibilities):
  - 1st and 2nd covering can be ordered in leather with same category.
  - 1st covering in leather and 2nd covering in fabric by selecting any color from the article Brezza.
  - 1st covering in leather (any category) and 2nd covering in leather by selecting any color from the article Le Mans.
- When in fabric (3 combo possibilities):
  - 1st and 2nd covering can be ordered in fabric with same category.
  - 1st covering in fabric and 2nd covering in leather by selecting any color from the article Le Mans.
  - 1st covering in fabric (any category) and 2nd covering in fabric by selecting any color from the article Brezza.

## NOTES

---

- **SLIDING ADJUSTABLE BACKRESTS:** The backrest has a unique manual sliding system that can customize your comfort by increasing or decreasing the seat depth as you wish. The different positions of the backrest assist your preferable way to relax. The backrest operates as follows: At first you need to slide the backrest all the way to the back, to then slide it forward, finding the best position you want to keep it fixed, for back support. The backrest can have 20 positions.
- **ADJUSTABLE ARMS:** the arms are equipped with a manual ratchet mechanism that you can adjust:
  - for major arm support during formal seating.
  - for extra head support, in case you would like to lay down, in horizontal position.
- Its versatility includes two new elements that can be smartly used to complement your configurations:
  - a “self-standing backrest” (vers. 436)
  - a “self-standing armrest” (vers. 437)

Both are independent versions that “self-stand” thanks to a carefully studied weight placed internally in their base. You can feel free to move them around and place them as needed on the seating surface to easily provide back and arm support.

- **MANUAL & POWER SLIDING OPTIONS:**
  - Manual Sliding Versions: 516-517-492-493-731-732-735
  - Power Sliding Versions: 616-617-727-728-729-730-743**POWER SLIDING MECHANISM** allows the backrest to move forward or backward changing the depth of the seat. This mechanism is activated by two touch buttons placed on the seat.
- To allow modularity, the single elements can be put together thanks to the rubber stops under the legs.
- 212 version to be used only as a chaise longue while the 429 as a rectangular corner. These versions have same dimensions and look similar, but they differ from each other by the stitching.
  - > 429 version has extra stitching placed on the short side.
  - > 212 version has no stitching on all sides.
- A battery pack can be ordered with its own version code 830. For order entry please use XX for category and XXX for cover code. In order to optimize the duration of the battery, it is suggested to order one per each motion seat.



■ Vers. 239



■ Vers. 239







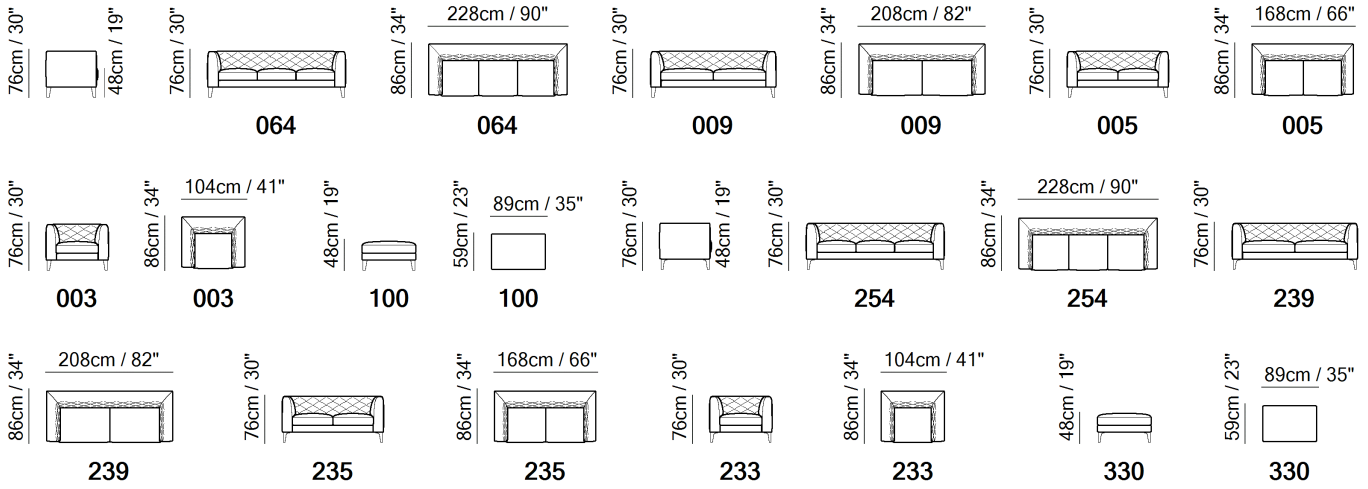

■ Vers. 239

**SCHEMATICS**



TECHNICAL INFORMATION

	<b>COVERING</b>	Leather <input checked="" type="checkbox"/>	Soft Cover <input checked="" type="checkbox"/>				
	<b>FILLING</b>	Arms	<input type="checkbox"/> Fiber <input checked="" type="checkbox"/> Foam <input type="checkbox"/> Feather/Fiber Mix <input type="checkbox"/> Feather	Seat cushion	<input type="checkbox"/> Fiber <input checked="" type="checkbox"/> Foam <input type="checkbox"/> Feather/Fiber Mix <input type="checkbox"/> Feather	Back cushion	<input type="checkbox"/> Fiber <input checked="" type="checkbox"/> Foam <input type="checkbox"/> Feather/Fiber Mix <input type="checkbox"/> Feather
	<b>COMFORT</b>	Standard Comfort <input checked="" type="checkbox"/>	Firm Comfort <input checked="" type="checkbox"/>				
	<b>FUNCTION</b>	Bed <input type="checkbox"/>	Electric motion <input type="checkbox"/>	Motion <input type="checkbox"/>	Recliner <input type="checkbox"/>	Sliding <input type="checkbox"/>	
	<b>VISUAL APPEARANCE*</b>	Low <input checked="" type="checkbox"/>	Medium <input type="checkbox"/>	High <input type="checkbox"/>			
	<b>LEGS</b>	Wood <input checked="" type="checkbox"/>	Metal <input checked="" type="checkbox"/>	Upholstered <input type="checkbox"/>	Plastic <input type="checkbox"/>	Castors <input type="checkbox"/>	

VISUAL APPEARANCE

The product may reveal various wrinkles due to the combination of Elasticity of the covering, characteristics of the interior construction and the design of the product.



Products with Visual Appearance listed as High or Medium would require higher degree of care, where seats and back cushions may require fluffing and plumping more often than Products with Visual Appearance listed as Low.

NOTES

- Available in leather (TG only) or fabric.
- Loose Seat Cushion (the seat cushions of the model are not fixed to the frame)
- Tight Back Cushion (the back cushions of the models are fixed to the frame)
- Internal wooden frame.
- Feet will be in a bag inside the package and requires assembling.
- The model will be wrapped in a plastic bag.
- Feet available in wood finishings 09 (Walnut) / 18 (Wengè)
- Second option versions have feet available in lacquered metal 82 (camel), 83 (moka) and 70 (brushed brass)
- Feet height 17,0 cm

NOTES

---



■ Vers. T66



■ Vers. 182+221



■ Vers. 182+221



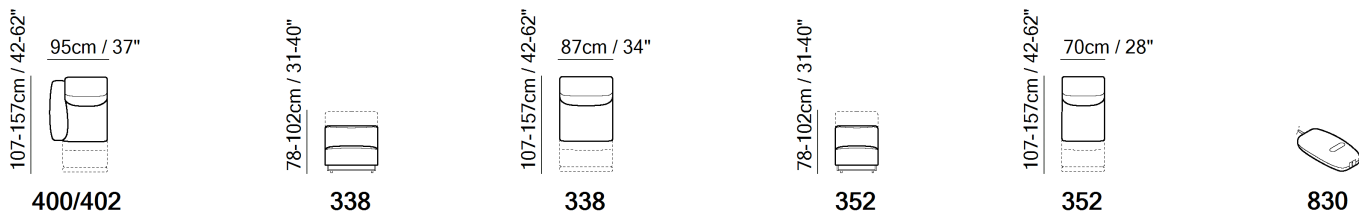
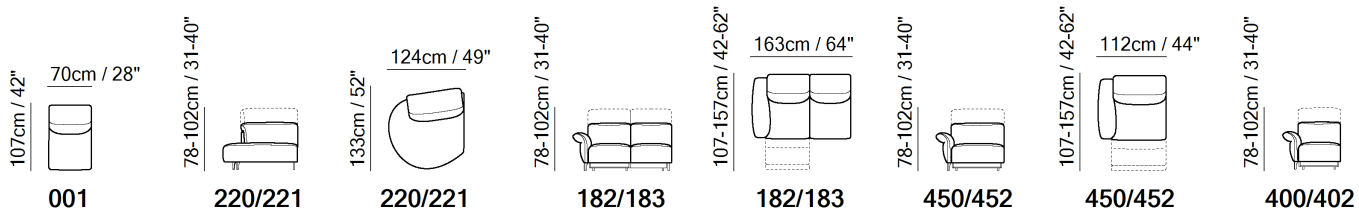
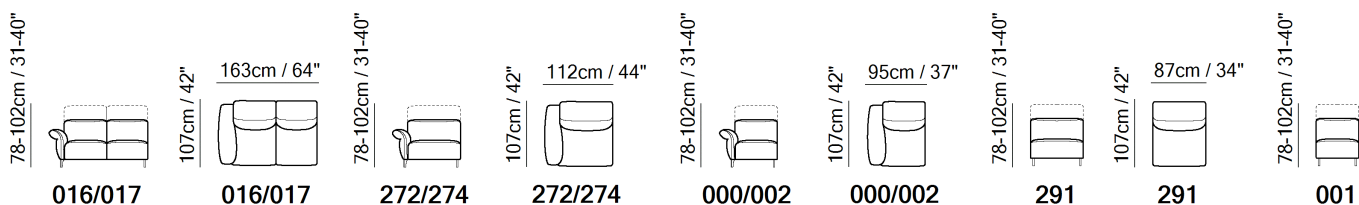
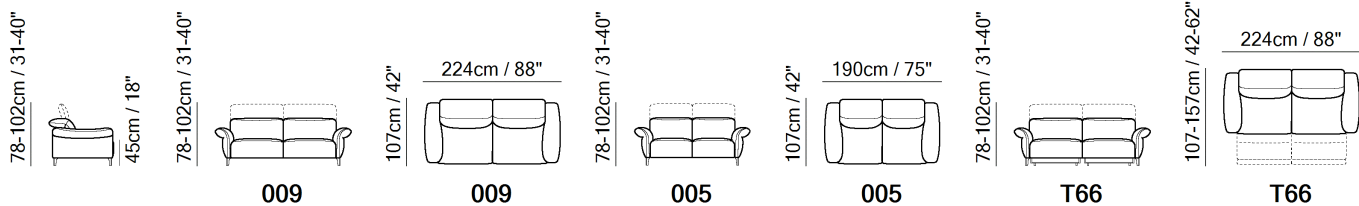

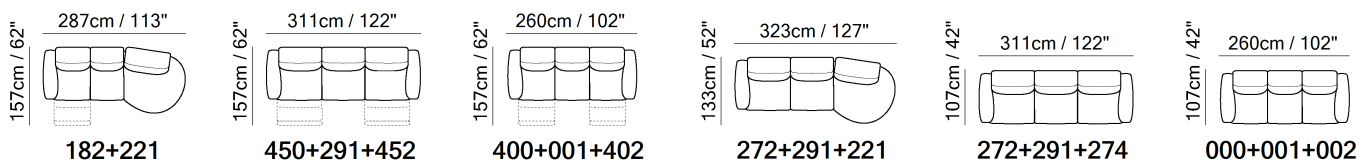

SCHEMATICS



COMPOSITION EXAMPLES



TECHNICAL INFORMATION

	<b>COVERING</b>	Leather <input checked="" type="checkbox"/>	Soft Cover <input checked="" type="checkbox"/>				
	<b>FILLING</b>	Arms	<input type="checkbox"/> Fiber <input checked="" type="checkbox"/> Foam <input type="checkbox"/> Feather/Fiber Mix <input type="checkbox"/> Feather	Seat cushion	<input type="checkbox"/> Fiber <input checked="" type="checkbox"/> Foam <input type="checkbox"/> Feather/Fiber Mix <input type="checkbox"/> Feather	Back cushion	<input type="checkbox"/> Fiber <input checked="" type="checkbox"/> Foam <input type="checkbox"/> Feather/Fiber Mix <input type="checkbox"/> Feather
	<b>COMFORT</b>	Firm Comfort <input checked="" type="checkbox"/>	Standard Comfort <input checked="" type="checkbox"/>				
	<b>FUNCTION</b>	Bed <input type="checkbox"/>	Electric motion <input checked="" type="checkbox"/>	Motion <input checked="" type="checkbox"/>	Recliner <input type="checkbox"/>	Sliding <input type="checkbox"/>	
	<b>VISUAL APPEARANCE*</b>	Low <input checked="" type="checkbox"/>	Medium <input type="checkbox"/>	High <input type="checkbox"/>			
	<b>LEGS</b>	Metal <input checked="" type="checkbox"/>	Wood <input type="checkbox"/>	Castors <input type="checkbox"/>	Plastic <input type="checkbox"/>	Upholstered <input type="checkbox"/>	

VISUAL APPEARANCE

The product may reveal various wrinkles due to the combination of Elasticity of the covering, characteristics of the interior construction and the design of the product.



Products with Visual Appearance listed as High or Medium would require higher degree of care, where seats and back cushions may require fluffing and plumping more often than Products with Visual Appearance listed as Low.

NOTES

- Available in leather (TG only) or fabric.
- SINGLE POWER MOTION: Power mechanism that activates a smooth system reclining seat, backrest and footrest for maximum relaxation
- Smart touch buttons to activate power reclining functions positioned on the side of the seating
- The model has manual adjustable headrest.
- Feet available in metal finishings 77 (Glossy Chromed) / 79 (Matte Black)

NOTES

---



■ Vers. 064



■ Vers. 064







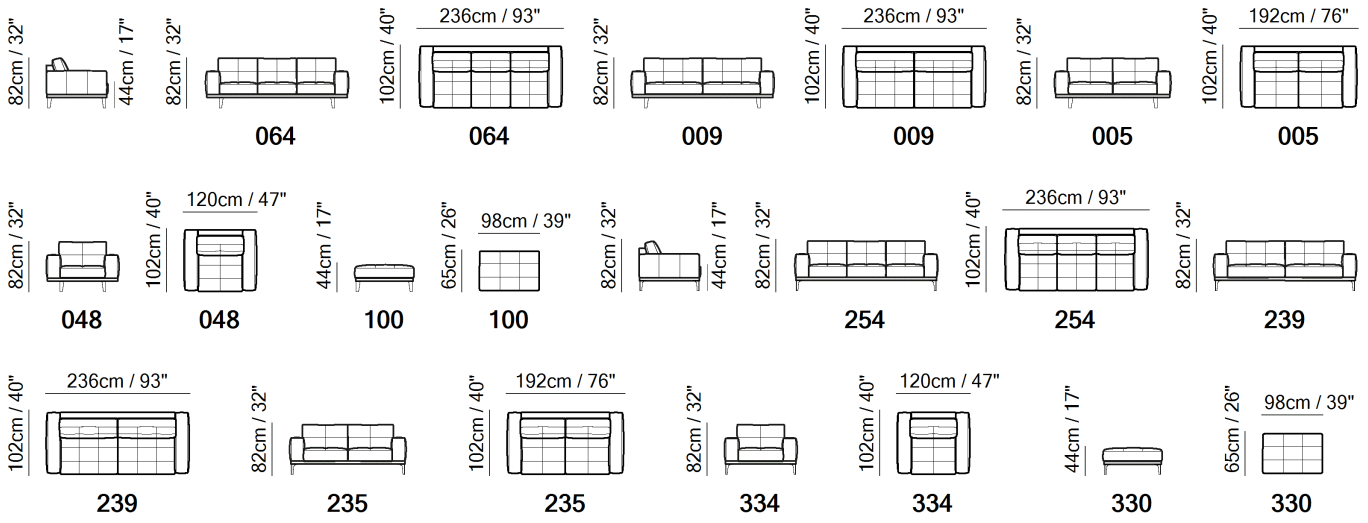

■ Vers. 009

SCHEMATICS



TECHNICAL INFORMATION

	<b>COVERING</b>	Leather <input checked="" type="checkbox"/>	Soft Cover <input checked="" type="checkbox"/>				
	<b>FILLING</b>	Arms	<input type="checkbox"/> Fiber <input checked="" type="checkbox"/> Foam <input type="checkbox"/> Feather/Fiber Mix <input type="checkbox"/> Feather	Seat cushion	<input type="checkbox"/> Fiber <input checked="" type="checkbox"/> Foam <input type="checkbox"/> Feather/Fiber Mix <input type="checkbox"/> Feather	Back cushion	<input type="checkbox"/> Fiber <input checked="" type="checkbox"/> Foam <input type="checkbox"/> Feather/Fiber Mix <input type="checkbox"/> Feather
	<b>COMFORT</b>	Standard Comfort <input checked="" type="checkbox"/>	Firm Comfort <input checked="" type="checkbox"/>				
	<b>FUNCTION</b>	Bed <input type="checkbox"/>	Electric motion <input type="checkbox"/>	Motion <input type="checkbox"/>	Recliner <input type="checkbox"/>	Sliding <input type="checkbox"/>	
	<b>VISUAL APPEARANCE*</b>	Low <input checked="" type="checkbox"/>	Medium <input type="checkbox"/>	High <input type="checkbox"/>			
	<b>LEGS</b>	Wood <input checked="" type="checkbox"/>	Metal <input checked="" type="checkbox"/>	Upholstered <input type="checkbox"/>	Plastic <input type="checkbox"/>	Castors <input type="checkbox"/>	

VISUAL APPEARANCE

The product may reveal various wrinkles due to the combination of Elasticity of the covering, characteristics of the interior construction and the design of the product.



Products with Visual Appearance listed as High or Medium would require higher degree of care, where seats and back cushions may require fluffing and plumping more often than Products with Visual Appearance listed as Low.

NOTES

- Available in leather or fabric.
- Feet available in wood finishings 09 (Walnut) / 18 (Wengè)
- Second option versions are available in metal leg finishings (79 matt black or 70 brushed brass)

NOTES

---



■ Vers. 063



■ Vers. 132







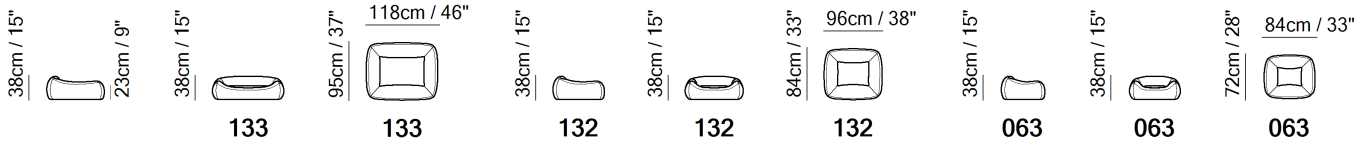

■ Vers. 133

SCHEMATICS



TECHNICAL INFORMATION

	<b>COVERING</b>	Soft Cover <input checked="" type="checkbox"/>					
	<b>FILLING</b>	Arms	<input checked="" type="checkbox"/> Fiber <input type="checkbox"/> Foam <input type="checkbox"/> Feather/Fiber Mix <input type="checkbox"/> Feather	Seat cushion	<input checked="" type="checkbox"/> Fiber <input type="checkbox"/> Foam <input type="checkbox"/> Feather/Fiber Mix <input type="checkbox"/> Feather	Back cushion	<input checked="" type="checkbox"/> Fiber <input type="checkbox"/> Foam <input type="checkbox"/> Feather/Fiber Mix <input type="checkbox"/> Feather
	<b>COMFORT</b>	Firm Comfort <input type="checkbox"/>	Standard Comfort <input checked="" type="checkbox"/>				
	<b>FUNCTION</b>	Bed <input type="checkbox"/>	Electric motion <input type="checkbox"/>	Motion <input type="checkbox"/>	Recliner <input type="checkbox"/>	Sliding <input type="checkbox"/>	
	<b>VISUAL APPEARANCE*</b>	Low <input checked="" type="checkbox"/>	Medium <input type="checkbox"/>	High <input type="checkbox"/>			
	<b>LEGS</b>	Metal <input type="checkbox"/>	Wood <input type="checkbox"/>	Castors <input type="checkbox"/>	Plastic <input type="checkbox"/>	Upholstered <input type="checkbox"/>	

VISUAL APPEARANCE

The product may reveal various wrinkles due to the combination of Elasticity of the covering, characteristics of the interior construction and the design of the product.



Products with Visual Appearance listed as High or Medium would require higher degree of care, where seats and back cushions may require fluffing and plumping more often than Products with Visual Appearance listed as Low.

NOTES

## NOTES

---



■ Vers. 768



■ Vers. 750+747+752



■ Vers. 765+769+436



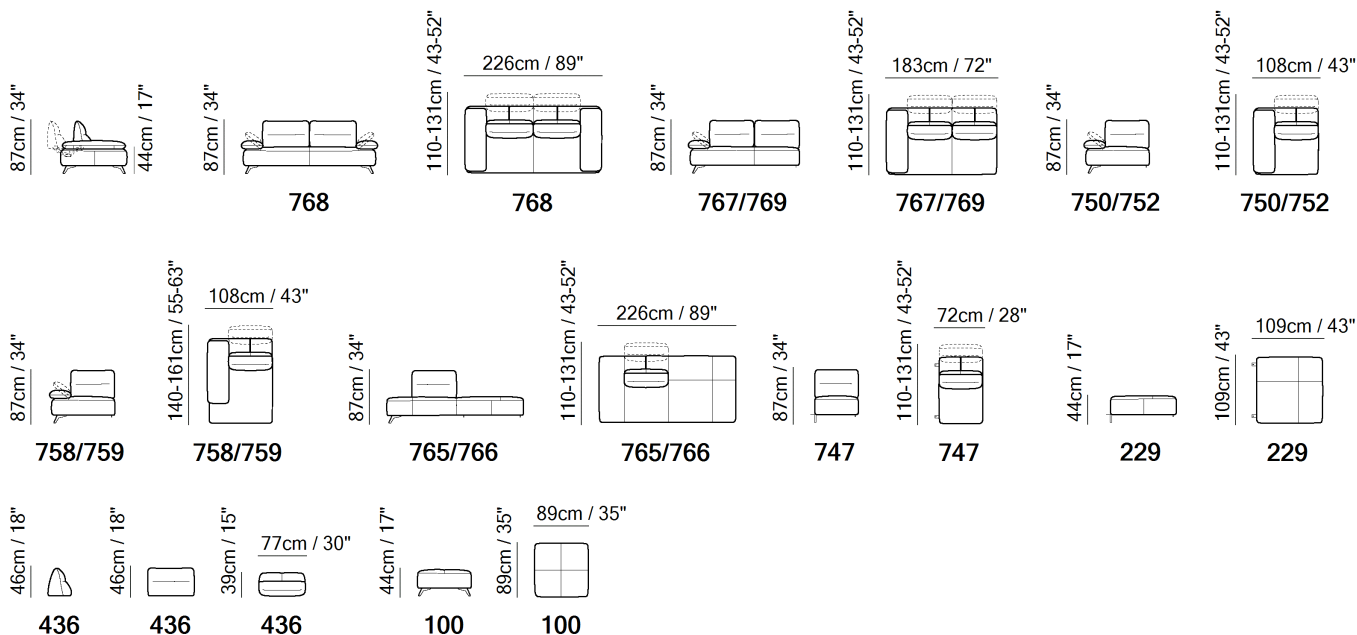

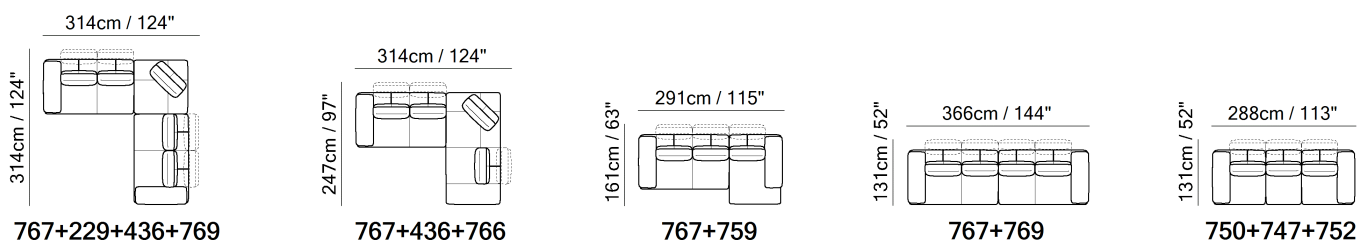

SCHEMATICS



COMPOSITION EXAMPLES



TECHNICAL INFORMATION

	<b>COVERING</b>	Leather <input checked="" type="checkbox"/>	Soft Cover <input checked="" type="checkbox"/>				
	<b>FILLING</b>	Arms	<input type="checkbox"/> Fiber <input checked="" type="checkbox"/> Foam <input type="checkbox"/> Feather/Fiber Mix <input type="checkbox"/> Feather	Seat cushion	<input type="checkbox"/> Fiber <input checked="" type="checkbox"/> Foam <input type="checkbox"/> Feather/Fiber Mix <input type="checkbox"/> Feather	Back cushion	<input type="checkbox"/> Fiber <input checked="" type="checkbox"/> Foam <input type="checkbox"/> Feather/Fiber Mix <input type="checkbox"/> Feather
	<b>COMFORT</b>	Standard Comfort <input checked="" type="checkbox"/>	Firm Comfort <input type="checkbox"/>				
	<b>FUNCTION</b>	Bed <input type="checkbox"/>	Electric motion <input type="checkbox"/>	Motion <input type="checkbox"/>	Recliner <input type="checkbox"/>	Sliding <input type="checkbox"/>	
	<b>VISUAL APPEARANCE*</b>	Low <input checked="" type="checkbox"/>	Medium <input type="checkbox"/>	High <input type="checkbox"/>			
	<b>LEGS</b>	Wood <input type="checkbox"/>	Metal <input checked="" type="checkbox"/>	Upholstered <input type="checkbox"/>	Plastic <input type="checkbox"/>	Castors <input type="checkbox"/>	

VISUAL APPEARANCE

The product may reveal various wrinkles due to the combination of Elasticity of the covering, characteristics of the interior construction and the design of the product.



Products with Visual Appearance listed as High or Medium would require higher degree of care, where seats and back cushions may require fluffing and plumping more often than Products with Visual Appearance listed as Low.

NOTES

- Available in leather (TG only) or fabric.
- Manually adjustable backrest through a tilting mechanism: 2 positions, back and forth.
- Manually adjustable arm with ratchet mechanism.
- Feet available in metal finishings 77 (Glossy Chromed) / 79 (Matte Black)
- Feet height 12,5 cm

NOTES

---



■ Vers. 272+045+291+274



■ Vers. 272+291+274



■ Vers. 272+045+274



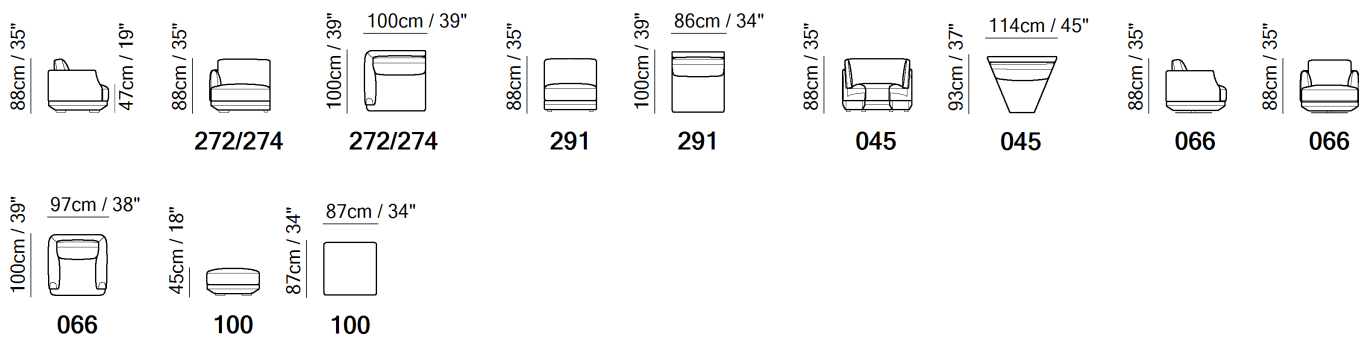

SCHEMATICS

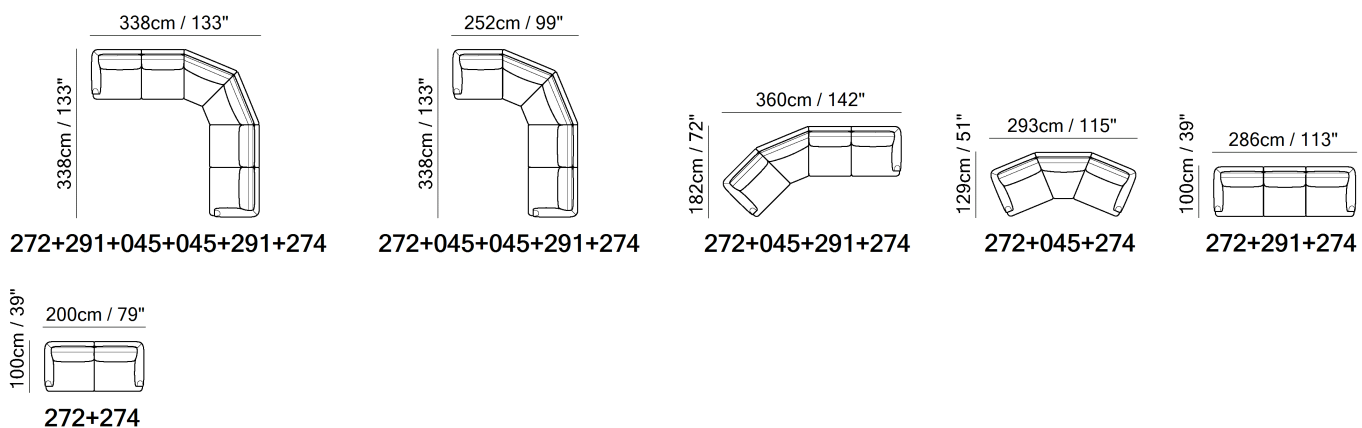

COMPOSITION EXAMPLES



TECHNICAL INFORMATION

	<b>COVERING</b>	Leather <input checked="" type="checkbox"/>	Soft Cover <input checked="" type="checkbox"/>			
	<b>FILLING</b>	Arms <input type="checkbox"/> Fiber <input checked="" type="checkbox"/> Foam <input type="checkbox"/> Feather/Fiber Mix <input type="checkbox"/> Feather	Seat cushion <input type="checkbox"/> Fiber <input checked="" type="checkbox"/> Foam <input type="checkbox"/> Feather/Fiber Mix <input type="checkbox"/> Feather	Back cushion <input type="checkbox"/> Fiber <input checked="" type="checkbox"/> Foam <input type="checkbox"/> Feather/Fiber Mix <input type="checkbox"/> Feather		
	<b>COMFORT</b>	Firm Comfort <input type="checkbox"/>	Standard Comfort <input checked="" type="checkbox"/>			
	<b>FUNCTION</b>	Bed <input type="checkbox"/>	Electric motion <input type="checkbox"/>	Motion <input type="checkbox"/>	Recliner <input type="checkbox"/>	Sliding <input type="checkbox"/>
	<b>VISUAL APPEARANCE*</b>	Low <input checked="" type="checkbox"/>	Medium <input type="checkbox"/>	High <input type="checkbox"/>		
	<b>LEGS</b>	Metal <input type="checkbox"/>	Wood <input checked="" type="checkbox"/>	Castors <input type="checkbox"/>	Plastic <input checked="" type="checkbox"/>	Upholstered <input type="checkbox"/>

VISUAL APPEARANCE

The product may reveal various wrinkles due to the combination of Elasticity of the covering, characteristics of the interior construction and the design of the product.



Products with Visual Appearance listed as High or Medium would require higher degree of care, where seats and back cushions may require fluffing and plumping more often than Products with Visual Appearance listed as Low.

NOTES

- Available in leather (TG only) or fabric.
- Tight Seat Cushion (the seat cushions of the models are fixed to the frame)
- Loose Back Cushion (the back cushions of the model are not fixed to the frame)
- No Leather/Fabric Side (the sectional pieces have the side covered with lining and not leather nor fabric)
- Feet available in wood finishings 09 (Walnut) / 18 (Wengè)
- Feet height 4,0 cm

NOTES

---



■ Vers. 064



■ Vers. 009



■ Vers. 003

SCHEMATICS

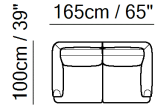
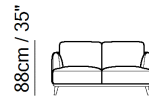
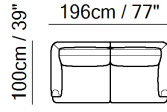
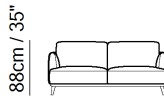
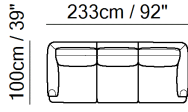
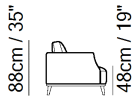

064

064

009

009

005

005

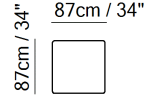
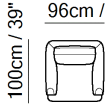







003

003

100

100

TECHNICAL INFORMATION

	<b>COVERING</b>	Leather <input checked="" type="checkbox"/>	Soft Cover <input checked="" type="checkbox"/>				
	<b>FILLING</b>	Arms	<input type="checkbox"/> Fiber <input checked="" type="checkbox"/> Foam <input type="checkbox"/> Feather/Fiber Mix <input type="checkbox"/> Feather	Seat cushion	<input type="checkbox"/> Fiber <input checked="" type="checkbox"/> Foam <input type="checkbox"/> Feather/Fiber Mix <input type="checkbox"/> Feather	Back cushion	<input type="checkbox"/> Fiber <input checked="" type="checkbox"/> Foam <input type="checkbox"/> Feather/Fiber Mix <input type="checkbox"/> Feather
	<b>COMFORT</b>	Standard Comfort <input checked="" type="checkbox"/>	Firm Comfort <input type="checkbox"/>				
	<b>FUNCTION</b>	Bed <input type="checkbox"/>	Electric motion <input type="checkbox"/>	Motion <input type="checkbox"/>	Recliner <input type="checkbox"/>	Sliding <input type="checkbox"/>	
	<b>VISUAL APPEARANCE*</b>	Low <input checked="" type="checkbox"/>	Medium <input type="checkbox"/>	High <input type="checkbox"/>			
	<b>LEGS</b>	Wood <input checked="" type="checkbox"/>	Metal <input type="checkbox"/>	Upholstered <input type="checkbox"/>	Plastic <input type="checkbox"/>	Castors <input type="checkbox"/>	

VISUAL APPEARANCE

The product may reveal various wrinkles due to the combination of Elasticity of the covering, characteristics of the interior construction and the design of the product.



Products with Visual Appearance listed as High or Medium would require higher degree of care, where seats and back cushions may require fluffing and plumping more often than Products with Visual Appearance listed as Low.

NOTES

- Available in leather (TG only) or fabric.
- Tight Seat Cushion (the seat cushions of the models are fixed to the frame)
- Loose Back Cushion (the back cushions of the model are not fixed to the frame)
- The model will be wrapped in a plastic bag.
- Wooden base and legs available in finishing 09 (Walnut) / 18 (Wengè)
- Feet height 14,5

NOTES

---



■ Vers. 200+217







■ Vers. 200+217



■ Vers. 200+217



TECHNICAL INFORMATION

	<b>COVERING</b>	Leather <input checked="" type="checkbox"/>	Soft Cover <input checked="" type="checkbox"/>			
	<b>FILLING</b>	Arms <input type="checkbox"/> Fiber <input checked="" type="checkbox"/> Foam <input type="checkbox"/> Feather/Fiber Mix <input type="checkbox"/> Feather	Seat cushion <input checked="" type="checkbox"/> Fiber <input checked="" type="checkbox"/> Foam <input type="checkbox"/> Feather/Fiber Mix <input type="checkbox"/> Feather	Back cushion <input checked="" type="checkbox"/> Fiber <input type="checkbox"/> Foam <input type="checkbox"/> Feather/Fiber Mix <input type="checkbox"/> Feather		
	<b>COMFORT</b>	Firm Comfort <input type="checkbox"/>	Standard Comfort <input checked="" type="checkbox"/>			
	<b>FUNCTION</b>	Bed <input checked="" type="checkbox"/>	Electric motion <input type="checkbox"/>	Motion <input type="checkbox"/>	Recliner <input type="checkbox"/>	Sliding <input type="checkbox"/>
	<b>VISUAL APPEARANCE*</b>	Low <input type="checkbox"/>	Medium <input checked="" type="checkbox"/>	High <input type="checkbox"/>		
	<b>LEGS</b>	Metal <input type="checkbox"/>	Wood <input checked="" type="checkbox"/>	Castors <input type="checkbox"/>	Plastic <input type="checkbox"/>	Upholstered <input type="checkbox"/>

VISUAL APPEARANCE

The product may reveal various wrinkles due to the combination of Elasticity of the covering, characteristics of the interior construction and the design of the product.



Products with Visual Appearance listed as High or Medium would require higher degree of care, where seats and back cushions may require fluffing and plumping more often than Products with Visual Appearance listed as Low.

BED MECHANISM & MATTRESS

MECHANISM		MATTRESS		
VERSIONS	TYPE	VERSIONS	TYPE	DIMENSIONS
008,022,023	Ready-Bed electro-welded - Double folding	008,022,023	Polyurethane foam	W L H 140 190 13
027	Ready-Bed electro-welded - Double folding	027	Polyurethane foam	160 190 13

**Ready-Bed electro-welded** The back cushion goes under the bed mechanism.

NOTES

- Available in leather (TG only) or fabric.
- Packaging: plastic wrap for stationary versions and cardboard box for motion/sofabed versions
- Feet available in wood finishings 09 (Walnut) / 18 (Wengè)
- Feet height 4,0 cm

NOTES

---



■ Vers. 066



■ Vers. 066







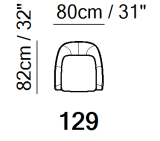
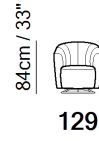
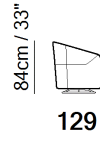
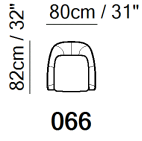

■ Vers. 066

SCHEMATICS

---



TECHNICAL INFORMATION

	<b>COVERING</b>	Leather <input checked="" type="checkbox"/>	Soft Cover <input checked="" type="checkbox"/>				
	<b>FILLING</b>	Arms	<input type="checkbox"/> Fiber <input checked="" type="checkbox"/> Foam <input type="checkbox"/> Feather/Fiber Mix <input type="checkbox"/> Feather	Seat cushion	<input type="checkbox"/> Fiber <input checked="" type="checkbox"/> Foam <input type="checkbox"/> Feather/Fiber Mix <input type="checkbox"/> Feather	Back cushion	<input type="checkbox"/> Fiber <input checked="" type="checkbox"/> Foam <input type="checkbox"/> Feather/Fiber Mix <input type="checkbox"/> Feather
	<b>COMFORT</b>	Standard Comfort <input checked="" type="checkbox"/>	Firm Comfort <input type="checkbox"/>				
	<b>FUNCTION</b>	Bed <input type="checkbox"/>	Electric motion <input type="checkbox"/>	Motion <input type="checkbox"/>	Recliner <input type="checkbox"/>	Sliding <input type="checkbox"/>	
	<b>VISUAL APPEARANCE*</b>	Low <input checked="" type="checkbox"/>	Medium <input type="checkbox"/>	High <input type="checkbox"/>			
	<b>LEGS</b>	Wood <input type="checkbox"/>	Metal <input type="checkbox"/>	Upholstered <input type="checkbox"/>	Plastic <input type="checkbox"/>	Castors <input type="checkbox"/>	

VISUAL APPEARANCE

The product may reveal various wrinkles due to the combination of Elasticity of the covering, characteristics of the interior construction and the design of the product.



Products with Visual Appearance listed as High or Medium would require higher degree of care, where seats and back cushions may require fluffing and plumping more often than Products with Visual Appearance listed as Low.

NOTES

NOTES

---



■ Vers. F50+045+F38+F52



■ Vers. 272+045+291+F52



■ Vers. 009



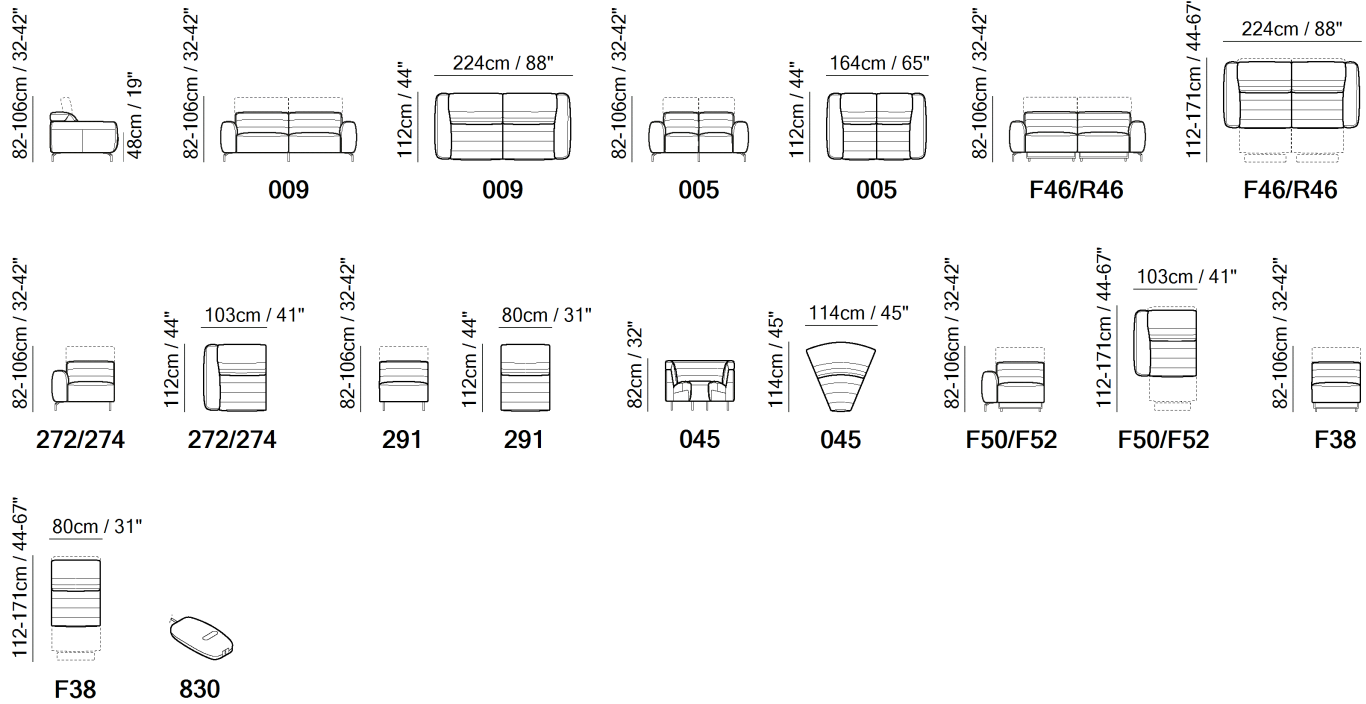

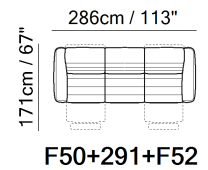
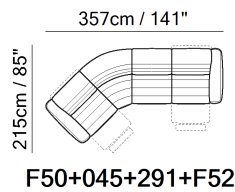
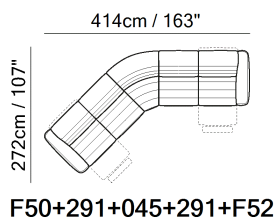

SCHEMATICS



COMPOSITION EXAMPLES



TECHNICAL INFORMATION

	<b>COVERING</b>	Leather <input checked="" type="checkbox"/>	Soft Cover <input checked="" type="checkbox"/>				
	<b>FILLING</b>	Arms	<input type="checkbox"/> Fiber <input checked="" type="checkbox"/> Foam <input type="checkbox"/> Feather/Fiber Mix <input type="checkbox"/> Feather	Seat cushion	<input type="checkbox"/> Fiber <input checked="" type="checkbox"/> Foam <input type="checkbox"/> Feather/Fiber Mix <input type="checkbox"/> Feather	Back cushion	<input type="checkbox"/> Fiber <input checked="" type="checkbox"/> Foam <input type="checkbox"/> Feather/Fiber Mix <input type="checkbox"/> Feather
	<b>COMFORT</b>	Firm Comfort <input type="checkbox"/>	Standard Comfort <input checked="" type="checkbox"/>				
	<b>FUNCTION</b>	Bed <input type="checkbox"/>	Electric motion <input type="checkbox"/>	Motion <input checked="" type="checkbox"/>	Recliner <input type="checkbox"/>	Sliding <input type="checkbox"/>	
	<b>VISUAL APPEARANCE*</b>	Low <input checked="" type="checkbox"/>	Medium <input type="checkbox"/>	High <input type="checkbox"/>			
	<b>LEGS</b>	Metal <input checked="" type="checkbox"/>	Wood <input type="checkbox"/>	Castors <input type="checkbox"/>	Plastic <input type="checkbox"/>	Upholstered <input type="checkbox"/>	

VISUAL APPEARANCE

The product may reveal various wrinkles due to the combination of Elasticity of the covering, characteristics of the interior construction and the design of the product.



Products with Visual Appearance listed as High or Medium would require higher degree of care, where seats and back cushions may require fluffing and plumping more often than Products with Visual Appearance listed as Low.

NOTES

- Available in leather (TG only) or fabric.
- By distributing weight evenly across all pressure points, the zero-gravity power motion system makes you feel weightless. It takes the pressure off your spine and can promote circulation in the legs.  
The definition of Zero Gravity Reclining is the ability for your heart to be resting above your feet which provides proven health benefits.
- ZERO GRAVITY™ DUAL POWER MOTION: a unique power motion system that separately and independently activates the different functions, to adjust the seat recliner and the headrest, allowing you to reach extreme comfort in a “zero gravity” position.
- Switch #1: All in One Power Reclining mechanism that simultaneously reclines the back, activates a “comfort tilt” of the seat and a full extension of the footrest, taking you to a “zero gravity” position that will make you experience a total and unparalleled relaxation.
- Switch #2: Power Adjustable Headrest which allows you to recline the headrest forward with millimetric precision to support you with a perfect and proper posture.
- Functions are operated by the power switch located on outside panel of the arm which also allocates a USB charging port.
- A battery pack can be ordered with its own version code 830. For order entry please use XX for category and XXX for cover code. In order to optimize the duration of the battery, it is suggested to order one per each motion seat.
- Internal wooden frame.

## NOTES

---

- Feet will be in a bag inside the package and requires assembling.
- Packaging: Cardboard wrap.
- Feet available in metal finishings 77 (Glossy Chromed) / 79 (Matte Black) / 59 (Grey)
- Feet height 15 cm



■ Vers. 066







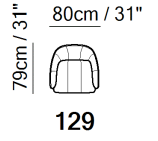
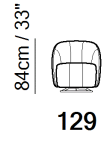
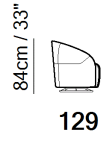
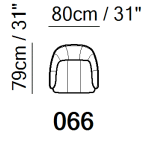
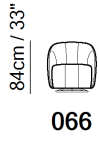

■ Vers. 066

SCHEMATICS

---



TECHNICAL INFORMATION

	<b>COVERING</b>	Leather <input checked="" type="checkbox"/>	Soft Cover <input checked="" type="checkbox"/>				
	<b>FILLING</b>	Arms	<input type="checkbox"/> Fiber <input checked="" type="checkbox"/> Foam <input type="checkbox"/> Feather/Fiber Mix <input type="checkbox"/> Feather	Seat cushion	<input type="checkbox"/> Fiber <input checked="" type="checkbox"/> Foam <input type="checkbox"/> Feather/Fiber Mix <input type="checkbox"/> Feather	Back cushion	<input type="checkbox"/> Fiber <input checked="" type="checkbox"/> Foam <input type="checkbox"/> Feather/Fiber Mix <input type="checkbox"/> Feather
	<b>COMFORT</b>	Standard Comfort <input checked="" type="checkbox"/>	Firm Comfort <input type="checkbox"/>				
	<b>FUNCTION</b>	Bed <input type="checkbox"/>	Electric motion <input type="checkbox"/>	Motion <input type="checkbox"/>	Recliner <input type="checkbox"/>	Sliding <input type="checkbox"/>	
	<b>VISUAL APPEARANCE*</b>	Low <input checked="" type="checkbox"/>	Medium <input type="checkbox"/>	High <input type="checkbox"/>			
	<b>LEGS</b>	Wood <input type="checkbox"/>	Metal <input type="checkbox"/>	Upholstered <input type="checkbox"/>	Plastic <input type="checkbox"/>	Castors <input type="checkbox"/>	

VISUAL APPEARANCE

The product may reveal various wrinkles due to the combination of Elasticity of the covering, characteristics of the interior construction and the design of the product.



Products with Visual Appearance listed as High or Medium would require higher degree of care, where seats and back cushions may require fluffing and plumping more often than Products with Visual Appearance listed as Low.

NOTES

NOTES

---



■ Vers. 066



■ Vers. 066

SCHEMATICS

---

84cm / 33"  
  
46cm / 18"

84cm / 33"  
  
**066**







79cm / 31"    80cm / 31"  
  
**066**

84cm / 33"  
  
**129**

84cm / 33"  
  
**129**

79cm / 31"    80cm / 31"  
  
**129**

TECHNICAL INFORMATION

	<b>COVERING</b>	Leather <input checked="" type="checkbox"/>	Soft Cover <input checked="" type="checkbox"/>				
	<b>FILLING</b>	Arms	<input type="checkbox"/> Fiber <input checked="" type="checkbox"/> Foam <input type="checkbox"/> Feather/Fiber Mix <input type="checkbox"/> Feather	Seat cushion	<input type="checkbox"/> Fiber <input checked="" type="checkbox"/> Foam <input type="checkbox"/> Feather/Fiber Mix <input type="checkbox"/> Feather	Back cushion	<input type="checkbox"/> Fiber <input checked="" type="checkbox"/> Foam <input type="checkbox"/> Feather/Fiber Mix <input type="checkbox"/> Feather
	<b>COMFORT</b>	Firm Comfort <input type="checkbox"/>	Standard Comfort <input checked="" type="checkbox"/>				
	<b>FUNCTION</b>	Bed <input type="checkbox"/>	Electric motion <input type="checkbox"/>	Motion <input type="checkbox"/>	Recliner <input type="checkbox"/>	Sliding <input type="checkbox"/>	
	<b>VISUAL APPEARANCE*</b>	Low <input checked="" type="checkbox"/>	Medium <input type="checkbox"/>	High <input type="checkbox"/>			
	<b>LEGS</b>	Metal <input type="checkbox"/>	Wood <input type="checkbox"/>	Castors <input type="checkbox"/>	Plastic <input type="checkbox"/>	Upholstered <input type="checkbox"/>	

VISUAL APPEARANCE

The product may reveal various wrinkles due to the combination of Elasticity of the covering, characteristics of the interior construction and the design of the product.



Products with Visual Appearance listed as High or Medium would require higher degree of care, where seats and back cushions may require fluffing and plumping more often than Products with Visual Appearance listed as Low.

NOTES

NOTES

---



■ Vers. 022+379



■ Vers. 022+379



■ Vers. 022+379



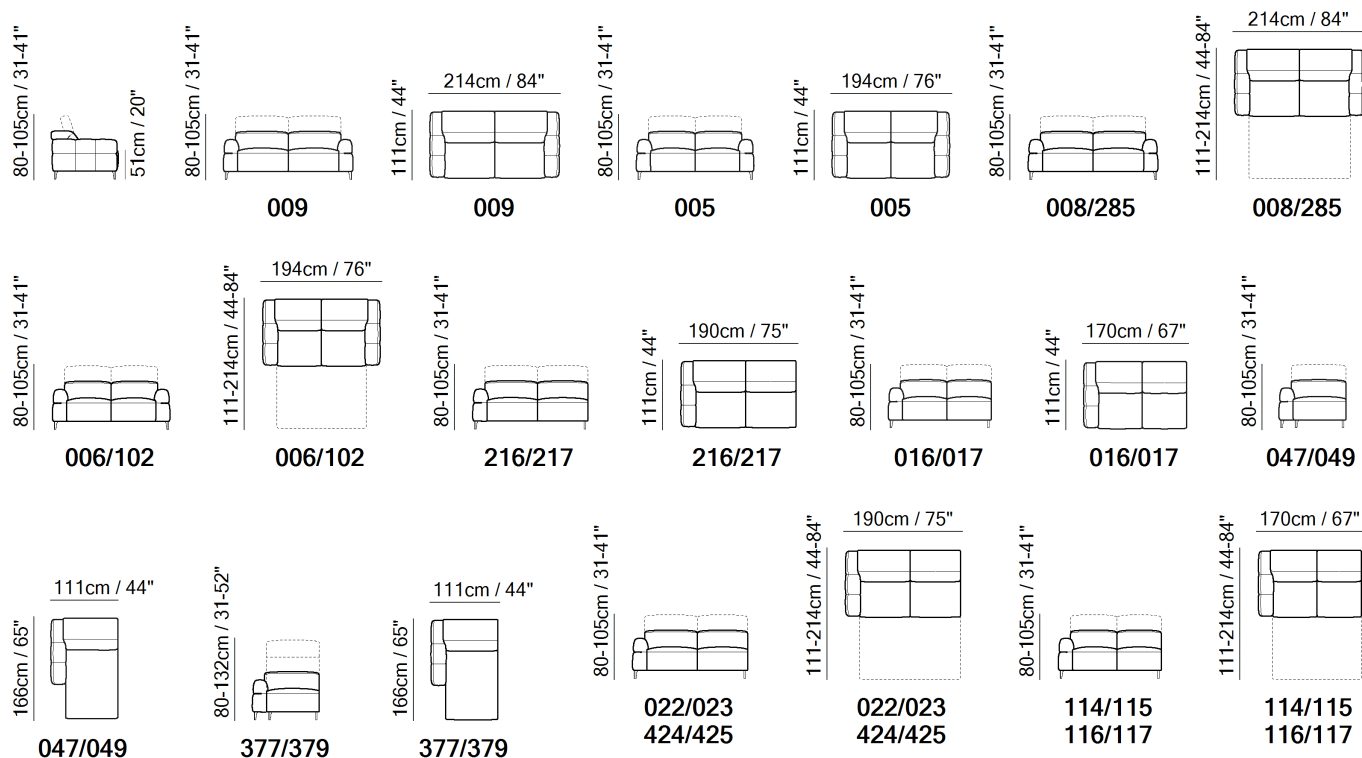

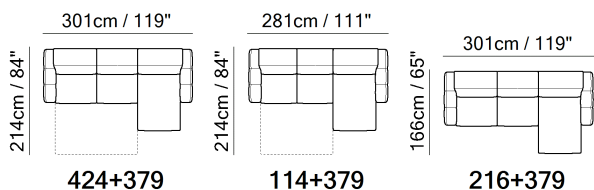

SCHEMATICS



COMPOSITION EXAMPLES



TECHNICAL INFORMATION

	<b>COVERING</b>	Leather <input checked="" type="checkbox"/>	Soft Cover <input checked="" type="checkbox"/>			
	<b>FILLING</b>	Arms <input type="checkbox"/> Fiber <input checked="" type="checkbox"/> Foam <input type="checkbox"/> Feather/Fiber Mix <input type="checkbox"/> Feather	Seat cushion <input type="checkbox"/> Fiber <input checked="" type="checkbox"/> Foam <input type="checkbox"/> Feather/Fiber Mix <input type="checkbox"/> Feather	Back cushion <input type="checkbox"/> Fiber <input checked="" type="checkbox"/> Foam <input type="checkbox"/> Feather/Fiber Mix <input type="checkbox"/> Feather		
	<b>COMFORT</b>	Standard Comfort <input checked="" type="checkbox"/>	Firm Comfort <input type="checkbox"/>			
	<b>FUNCTION</b>	Bed <input checked="" type="checkbox"/>	Electric motion <input type="checkbox"/>	Motion <input type="checkbox"/>	Recliner <input type="checkbox"/>	Sliding <input type="checkbox"/>
	<b>VISUAL APPEARANCE*</b>	Low <input checked="" type="checkbox"/>	Medium <input type="checkbox"/>	High <input type="checkbox"/>		
	<b>LEGS</b>	Wood <input type="checkbox"/>	Metal <input checked="" type="checkbox"/>	Upholstered <input type="checkbox"/>	Plastic <input type="checkbox"/>	Castors <input type="checkbox"/>

VISUAL APPEARANCE

The product may reveal various wrinkles due to the combination of Elasticity of the covering, characteristics of the interior construction and the design of the product.



Products with Visual Appearance listed as High or Medium would require higher degree of care, where seats and back cushions may require fluffing and plumping more often than Products with Visual Appearance listed as Low.

NOTES

- The Capri project has been designed to meet the need for an easy-to-use project equipped with a “ready to bed” mechanism while preserving the exceptional comfort of a traditional sofa.
- It’s modern and rounded design ensures unparalleled visual appeal and comfort:
  - Foam mattress with a height of 11 cm, available with dimension 190x140 and 193x120
  - Manually adjustable headrest across all versions
  - Chaise longue available with or without storage compartment
- Available in leather (TG only) or fabric.
- Internal wooden frame.
- Feet will be in a bag inside the package and requires assembling.
- The model will be wrapped in a plastic bag.
- Feet available in metal finishings 77 (Glossy Chromed) / 79 (Matte Black)

NOTES

---



■ Vers. 009





SCHEMATICS

99cm / 39" 50cm / 20" 99cm / 39"		99cm / 39"		101cm / 40" 200cm / 79"		99cm / 39"		101cm / 40" 168cm / 66"		99cm / 39"		101cm / 40" 103cm / 41"		99cm / 39"	
			<b>009</b>		<b>009</b>		<b>005</b>		<b>005</b>		<b>003</b>		<b>003</b>		<b>446</b>
101-156cm / 40-61" 198cm / 78"		99cm / 39"		101-156cm / 40-61" 166cm / 65"		99cm / 39"		101-156cm / 40-61" 102cm / 40"		99cm / 39"		101cm / 40" 100cm / 39"		99cm / 39"	
	<b>446</b>		<b>193</b>		<b>193</b>		<b>154</b>		<b>154</b>		<b>272/274</b>		<b>272/274</b>		<b>291</b>
101cm / 40" 80cm / 31"		99cm / 39"		119cm / 47" 119cm / 47"		99cm / 39"		101-156cm / 40-61" 99cm / 39"		99cm / 39"		101-156cm / 40-61" 80cm / 31"		99cm / 39"	
	<b>291</b>		<b>011</b>		<b>011</b>		<b>450/452</b>		<b>450/452</b>		<b>338</b>		<b>338</b>		<b>830</b>
99cm / 39" 200cm / 79"		101cm / 40" 168cm / 66"		99cm / 39" 103cm / 41"		101cm / 40" 168cm / 66"		99cm / 39"		101cm / 40" 103cm / 41"		99cm / 39"			
	<b>239</b>		<b>239</b>		<b>235</b>		<b>235</b>		<b>233</b>		<b>233</b>		<b>458</b>		
101-156cm / 40-61" 198cm / 78"		99cm / 39"		101-156cm / 40-61" 166cm / 65"		99cm / 39"		101-156cm / 40-61" 102cm / 40"		99cm / 39"		101cm / 40" 101cm / 40"		99cm / 39"	
	<b>458</b>		<b>393</b>		<b>393</b>		<b>454</b>		<b>454</b>		<b>382/384</b>		<b>382/384</b>		<b>381</b>
101cm / 40" 80cm / 31"		99cm / 39"		119cm / 47" 119cm / 47"		99cm / 39"		99cm / 39"		99cm / 39"					
	<b>381</b>		<b>489</b>		<b>489</b>		<b>514/515</b>		<b>514/515</b>		<b>638</b>		<b>638</b>		<b>830</b>

COMPOSITION EXAMPLES

156cm / 61" 279cm / 110"	
<b>450+291+274</b>	
156cm / 61" 278cm / 109"	
<b>450+338+452</b>	

TECHNICAL INFORMATION

	<b>COVERING</b>	Leather <input checked="" type="checkbox"/>	Soft Cover <input checked="" type="checkbox"/>				
	<b>FILLING</b>	Arms	<input type="checkbox"/> Fiber <input checked="" type="checkbox"/> Foam <input type="checkbox"/> Feather/Fiber Mix <input type="checkbox"/> Feather	Seat cushion	<input type="checkbox"/> Fiber <input checked="" type="checkbox"/> Foam <input type="checkbox"/> Feather/Fiber Mix <input type="checkbox"/> Feather	Back cushion	<input type="checkbox"/> Fiber <input checked="" type="checkbox"/> Foam <input type="checkbox"/> Feather/Fiber Mix <input type="checkbox"/> Feather
	<b>COMFORT</b>	Firm Comfort <input checked="" type="checkbox"/>	Standard Comfort <input checked="" type="checkbox"/>				
	<b>FUNCTION</b>	Bed <input type="checkbox"/>	Electric motion <input checked="" type="checkbox"/>	Motion <input checked="" type="checkbox"/>	Recliner <input checked="" type="checkbox"/>	Sliding <input type="checkbox"/>	
	<b>VISUAL APPEARANCE*</b>	Low <input checked="" type="checkbox"/>	Medium <input type="checkbox"/>	High <input type="checkbox"/>			
	<b>LEGS</b>	Metal <input type="checkbox"/>	Wood <input checked="" type="checkbox"/>	Castors <input type="checkbox"/>	Plastic <input type="checkbox"/>	Upholstered <input type="checkbox"/>	

VISUAL APPEARANCE

The product may reveal various wrinkles due to the combination of Elasticity of the covering, characteristics of the interior construction and the design of the product.



Products with Visual Appearance listed as High or Medium would require higher degree of care, where seats and back cushions may require fluffing and plumping more often than Products with Visual Appearance listed as Low.

NOTES

- Available in leather (TG only) or fabric.
- Single power mechanism with external switch on the side panel that activates recliner and includes an USB charging port.
- Headrest with manual adjustable tilt position available only on power motion versions.
- A battery pack can be ordered with its own version code 830. For order entry please use XX for category and XXX for cover code. In order to optimize the duration of the battery, it is suggested to order one per each motion seat.
- Tight Seat Cushion (the seat cushions of the models are fixed to the frame)
- Tight Back Cushion (the back cushions of the models are fixed to the frame)
- Internal wooden frame.
- Feet will be in a bag inside the package and requires assembling.
- Packaging: Cardboard wrap.
- Metal feet are available in two different finishes: 79 matt black or 89 glossy silver.
- Second option versions have feet available in wood finishings 09 (Walnut) / 18 (Wengè)
- Feet height 15,0 cm

NOTES

---



■ Vers. N50+291+N52



■ Vers. N50+291+N52







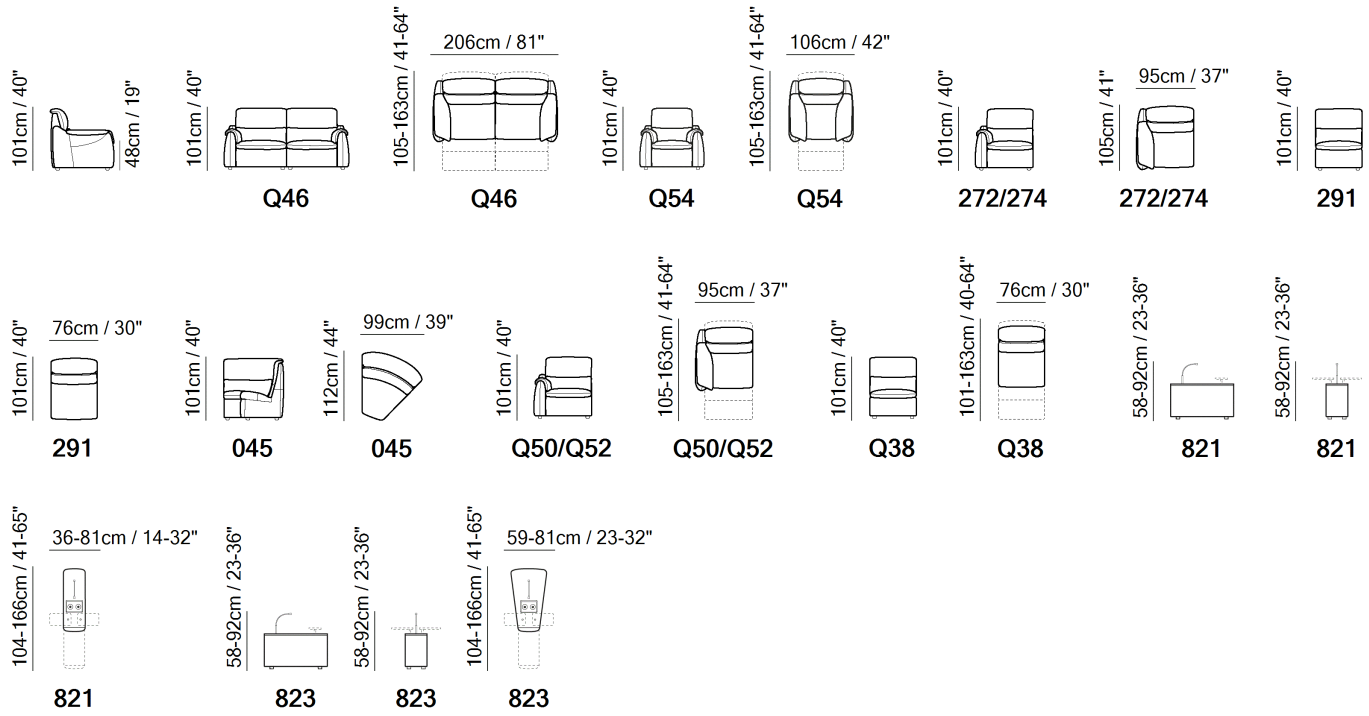

■ Vers. N50+291+N52

SCHEMATICS



TECHNICAL INFORMATION

	<b>COVERING</b>	Leather <input checked="" type="checkbox"/>	Soft Cover <input checked="" type="checkbox"/>			
	<b>FILLING</b>	Arms <input type="checkbox"/> Fiber <input checked="" type="checkbox"/> Foam <input type="checkbox"/> Feather/Fiber Mix <input type="checkbox"/> Feather	Seat cushion <input type="checkbox"/> Fiber <input checked="" type="checkbox"/> Foam <input type="checkbox"/> Feather/Fiber Mix <input type="checkbox"/> Feather	Back cushion <input type="checkbox"/> Fiber <input checked="" type="checkbox"/> Foam <input type="checkbox"/> Feather/Fiber Mix <input type="checkbox"/> Feather		
	<b>COMFORT</b>	Standard Comfort <input checked="" type="checkbox"/>	Firm Comfort <input checked="" type="checkbox"/>			
	<b>FUNCTION</b>	Bed <input type="checkbox"/>	Electric motion <input type="checkbox"/>	Motion <input type="checkbox"/>	Recliner <input type="checkbox"/>	Sliding <input type="checkbox"/>
	<b>VISUAL APPEARANCE*</b>	Low <input checked="" type="checkbox"/>	Medium <input type="checkbox"/>	High <input type="checkbox"/>		
	<b>LEGS</b>	Wood <input type="checkbox"/>	Metal <input type="checkbox"/>	Upholstered <input type="checkbox"/>	Plastic <input type="checkbox"/>	Castors <input type="checkbox"/>

VISUAL APPEARANCE

The product may reveal various wrinkles due to the combination of Elasticity of the covering, characteristics of the interior construction and the design of the product.



Products with Visual Appearance listed as High or Medium would require higher degree of care, where seats and back cushions may require fluffing and plumping more often than Products with Visual Appearance listed as Low.

NOTES

- Available in leather (TG only) or fabric.
- CUBICOMFORT™ Triple-Motion Technology is a registered trademark. It denotes a set of independent motion systems that activate the various elements of the sofa (seat, backrest, headrest and footrest) allowing each person to adjust their position of absolute comfort to the millimeter.
- Mech. 1: All in One Power Reclining mechanism simultaneously reclines the back and seat and footrest that allows you to reach a horizontal position for unlimited relaxation.
- Mech. 2: Power Lumbar Support allows you to adjust the lower part of the backrest by increasing or decreasing the pressure for a better back support.
- Mech. 3: Power Adjustable Headrest which allows you to recline the headrest forward with millimetric precision and reach a perfect relaxation position for great comfort.
- «Micromobility» Starting from the resting position, the sofa moves imperceptibly to keep the body’s muscles active. It works by slowly tilting the seat and footrest simultaneously with micromovements that improve blood circulation, contributing to a deeper state of relaxation.
- The multifunctional console, with a full wooden finish, features a spacious tabletop, a storage drawer, a built-in USB port, and connectors for adding optional features—blending style, convenience, and versatility. The console can be ordered with its own version code 821 or 823. For order entry please use XXX for alias code and finishing code ST49 ash brown or ST50 ash blonde.
- Switch Panel Pocket: A fully upholstered pocket housing the switch panel enhances the visual appeal of the model, offering a distinctive aesthetic element.

## NOTES

---

- Packaging: Cardboard wrap.
- Feet will be in a bag inside the package and requires assembling.
- Feet height 4,0 cm



■ Vers. Q50+Q38+Q52



■ Vers. Q50+Q38+Q52



■ Vers.



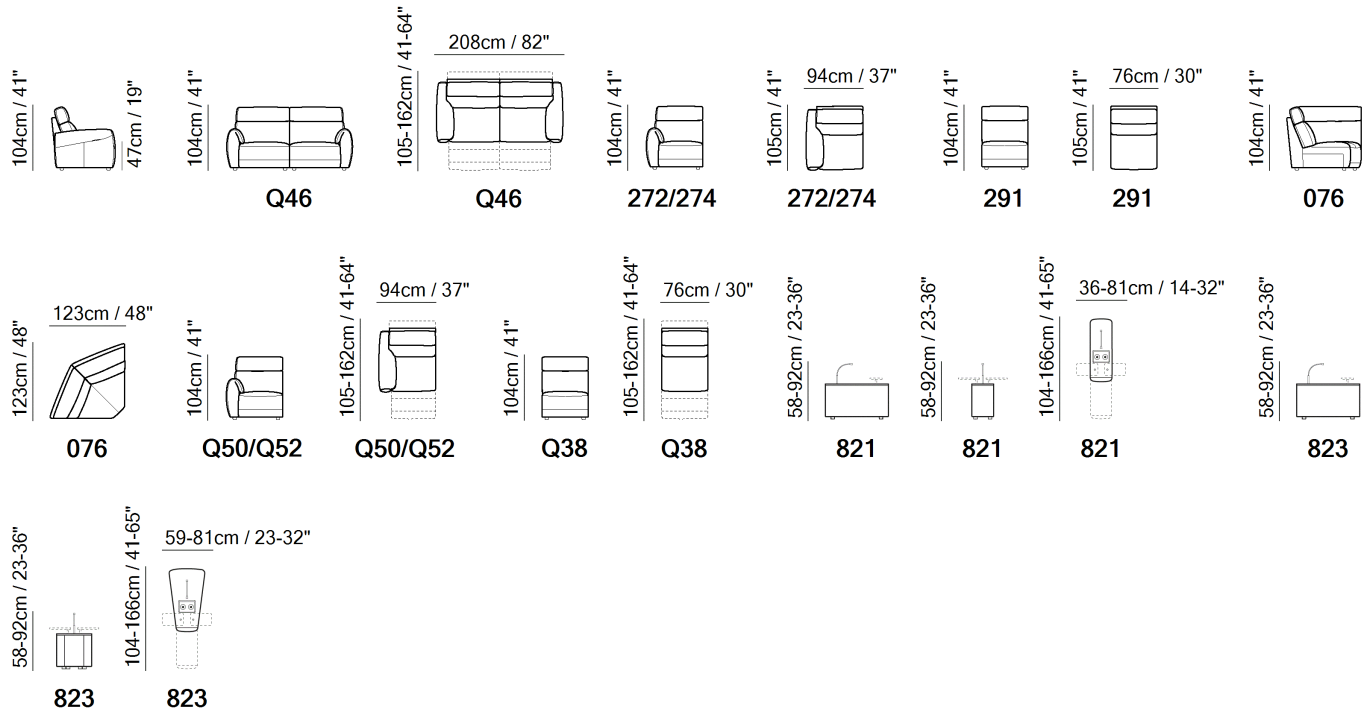

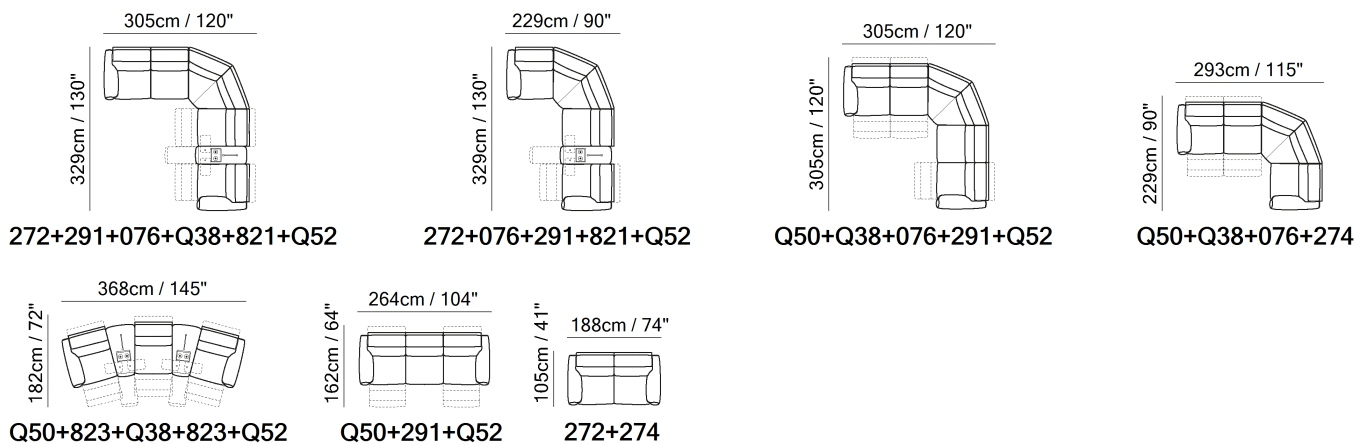

SCHEMATICS



COMPOSITION EXAMPLES



TECHNICAL INFORMATION

	<b>COVERING</b>	Leather <input checked="" type="checkbox"/>	Soft Cover <input checked="" type="checkbox"/>				
	<b>FILLING</b>	Arms	<input type="checkbox"/> Fiber <input checked="" type="checkbox"/> Foam <input type="checkbox"/> Feather/Fiber Mix <input type="checkbox"/> Feather	Seat cushion	<input type="checkbox"/> Fiber <input checked="" type="checkbox"/> Foam <input type="checkbox"/> Feather/Fiber Mix <input type="checkbox"/> Feather	Back cushion	<input type="checkbox"/> Fiber <input checked="" type="checkbox"/> Foam <input type="checkbox"/> Feather/Fiber Mix <input type="checkbox"/> Feather
	<b>COMFORT</b>	Firm Comfort <input checked="" type="checkbox"/>	Standard Comfort <input checked="" type="checkbox"/>				
	<b>FUNCTION</b>	Bed <input type="checkbox"/>	Electric motion <input type="checkbox"/>	Motion <input type="checkbox"/>	Recliner <input type="checkbox"/>	Sliding <input type="checkbox"/>	
	<b>VISUAL APPEARANCE*</b>	Low <input checked="" type="checkbox"/>	Medium <input type="checkbox"/>	High <input type="checkbox"/>			
	<b>LEGS</b>	Metal <input type="checkbox"/>	Wood <input type="checkbox"/>	Castors <input type="checkbox"/>	Plastic <input type="checkbox"/>	Upholstered <input type="checkbox"/>	

VISUAL APPEARANCE

The product may reveal various wrinkles due to the combination of Elasticity of the covering, characteristics of the interior construction and the design of the product.



Products with Visual Appearance listed as High or Medium would require higher degree of care, where seats and back cushions may require fluffing and plumping more often than Products with Visual Appearance listed as Low.

NOTES

- Available in leather (TG only) or fabric.
- By distributing weight evenly across all pressure points, the zero-gravity power motion system makes you feel weightless. It takes the pressure off your spine and can promote circulation in the legs.  
The definition of Zero Gravity Reclining is the ability for your heart to be resting above your feet which provides proven health benefits.
- ZERO GRAVITY™ DUAL POWER MOTION: a unique power motion system that separately and independently activates the different functions, to adjust the seat recliner and the headrest, allowing you to reach extreme comfort in a “zero gravity” position.
- «Micromobility» Starting from the resting position, the sofa moves imperceptibly to keep the body’s muscles active. It works by slowly tilting the seat and footrest simultaneously with micromovements that improve blood circulation, contributing to a deeper state of relaxation.
- The multifunctional console, with a full wooden finish, features a spacious tabletop, a storage drawer, a built-in USB port, and connectors for adding optional features—blending style, convenience, and versatility. The console can be ordered with its own version code 821 or 823. For order entry please use XXX for alias code and finishing code ST49 ash brown or ST50 ash blonde.
- Switch Panel Pocket: A fully upholstered pocket housing the switch panel enhances the visual appeal of the model, offering a distinctive aesthetic element.
- Feet will be in a bag inside the package and requires assembling.
- Packaging: Cardboard wrap.

**NOTES**

---







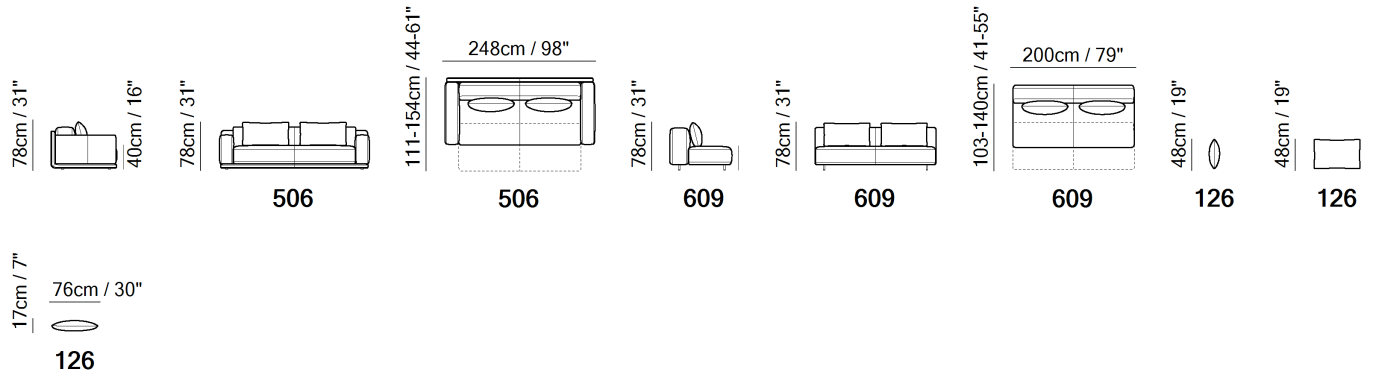

■ Vers. 506

SCHEMATICS



TECHNICAL INFORMATION

	<b>COVERING</b>	Soft Cover <input checked="" type="checkbox"/>					
	<b>FILLING</b>	Arms	<input type="checkbox"/> Fiber <input checked="" type="checkbox"/> Foam <input type="checkbox"/> Feather/Fiber Mix <input type="checkbox"/> Feather	Seat cushion	<input type="checkbox"/> Fiber <input checked="" type="checkbox"/> Foam <input type="checkbox"/> Feather/Fiber Mix <input type="checkbox"/> Feather	Back cushion	<input type="checkbox"/> Fiber <input checked="" type="checkbox"/> Foam <input type="checkbox"/> Feather/Fiber Mix <input type="checkbox"/> Feather
	<b>COMFORT</b>	Standard Comfort <input checked="" type="checkbox"/>	Firm Comfort <input type="checkbox"/>				
	<b>FUNCTION</b>	Bed <input type="checkbox"/>	Electric motion <input type="checkbox"/>	Motion <input type="checkbox"/>	Recliner <input type="checkbox"/>	Sliding <input checked="" type="checkbox"/>	
	<b>VISUAL APPEARANCE*</b>	Low <input checked="" type="checkbox"/>	Medium <input type="checkbox"/>	High <input type="checkbox"/>			
	<b>LEGS</b>	Wood <input type="checkbox"/>	Metal <input type="checkbox"/>	Upholstered <input type="checkbox"/>	Plastic <input type="checkbox"/>	Castors <input type="checkbox"/>	

VISUAL APPEARANCE

The product may reveal various wrinkles due to the combination of Elasticity of the covering, characteristics of the interior construction and the design of the product.



Products with Visual Appearance listed as High or Medium would require higher degree of care, where seats and back cushions may require fluffing and plumping more often than Products with Visual Appearance listed as Low.

NOTES

- Available only in fabric and can be ordered with 2 coverings (same category):  
1st.covering= sofa  
2nd.covering= Backrest pillows
- Sofabed with pull-out mechanism available with or without armrests.  
The opening mechanism operated by advancing the seat through a roto-translating motion, subsequently lowering the backrest to seamlessly transform the sofa into a comfortable bed.
- A compact storage compartment is positioned beneath the seating area, providing an ideal space for organizing pillows and bed linens.
- The orthopedic sleeping surface is designed with an electro-welded steel mesh, coated with durable epoxy powder for enhanced longevity and support.
- Vers.506 and 609 already come with 2 backrest pillows.

**NOTES**

---







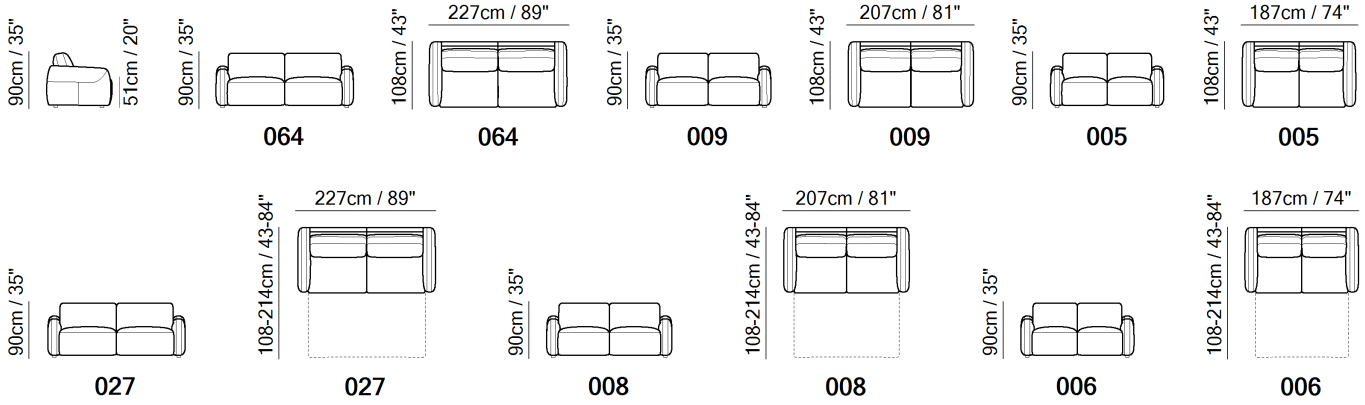

■ Vers. 008

SCHEMATICS



TECHNICAL INFORMATION

	<b>COVERING</b>	Leather <input checked="" type="checkbox"/>	Soft Cover <input checked="" type="checkbox"/>				
	<b>FILLING</b>	Arms	<input type="checkbox"/> Fiber <input checked="" type="checkbox"/> Foam <input type="checkbox"/> Feather/Fiber Mix <input type="checkbox"/> Feather	Seat cushion	<input type="checkbox"/> Fiber <input checked="" type="checkbox"/> Foam <input type="checkbox"/> Feather/Fiber Mix <input type="checkbox"/> Feather	Back cushion	<input type="checkbox"/> Fiber <input checked="" type="checkbox"/> Foam <input type="checkbox"/> Feather/Fiber Mix <input type="checkbox"/> Feather
	<b>COMFORT</b>	Firm Comfort <input type="checkbox"/>	Standard Comfort <input checked="" type="checkbox"/>				
	<b>FUNCTION</b>	Bed <input checked="" type="checkbox"/>	Electric motion <input type="checkbox"/>	Motion <input type="checkbox"/>	Recliner <input type="checkbox"/>	Sliding <input type="checkbox"/>	
	<b>VISUAL APPEARANCE*</b>	Low <input checked="" type="checkbox"/>	Medium <input type="checkbox"/>	High <input type="checkbox"/>			
	<b>LEGS</b>	Metal <input type="checkbox"/>	Wood <input type="checkbox"/>	Castors <input type="checkbox"/>	Plastic <input type="checkbox"/>	Upholstered <input type="checkbox"/>	

VISUAL APPEARANCE

The product may reveal various wrinkles due to the combination of Elasticity of the covering, characteristics of the interior construction and the design of the product.

-  Low
-  Medium
-  High

Products with Visual Appearance listed as High or Medium would require higher degree of care, where seats and back cushions may require fluffing and plumping more often than Products with Visual Appearance listed as Low.

NOTES

NOTES

---







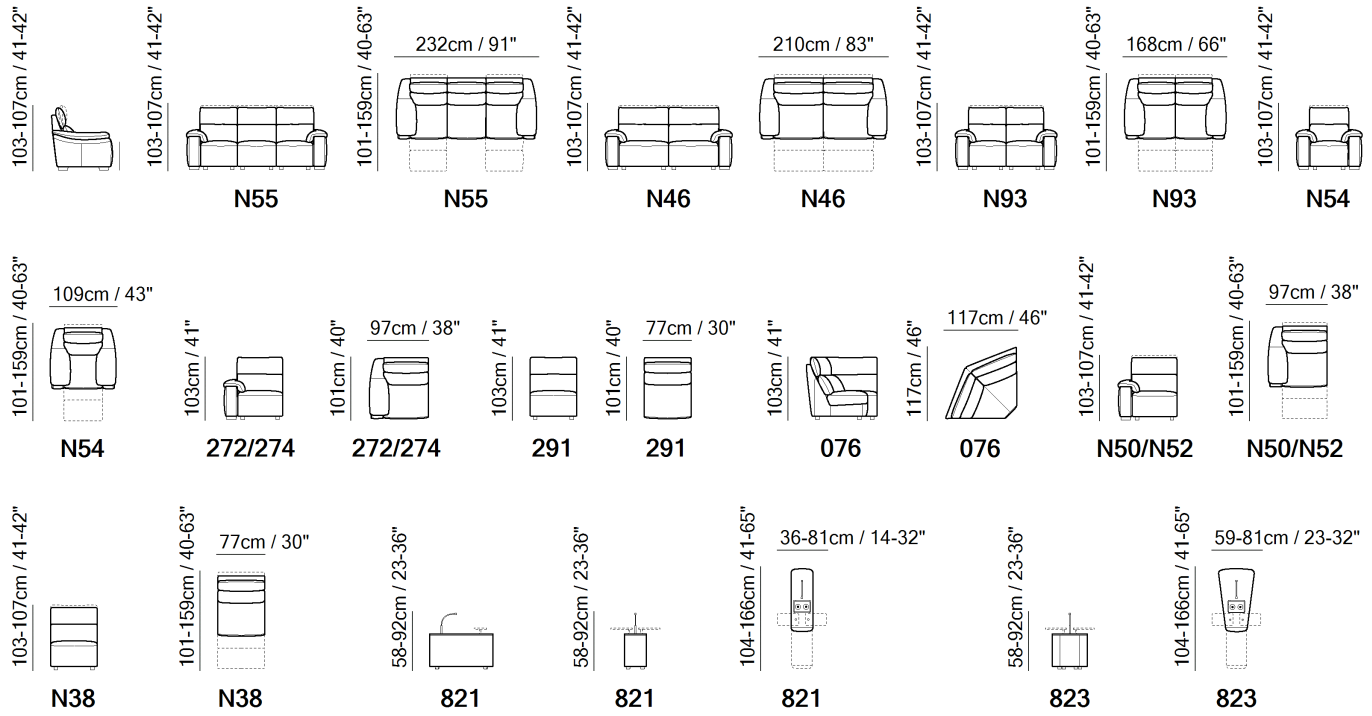

■ Vers. 272+291+076+N38+N52

SCHEMATICS



TECHNICAL INFORMATION

	<b>COVERING</b>	Leather <input checked="" type="checkbox"/>	Soft Cover <input checked="" type="checkbox"/>			
	<b>FILLING</b>	Arms <input type="checkbox"/> Fiber <input type="checkbox"/> Foam <input type="checkbox"/> Feather/Fiber Mix <input type="checkbox"/> Feather	Seat cushion <input type="checkbox"/> Fiber <input type="checkbox"/> Foam <input type="checkbox"/> Feather/Fiber Mix <input type="checkbox"/> Feather	Back cushion <input type="checkbox"/> Fiber <input type="checkbox"/> Foam <input type="checkbox"/> Feather/Fiber Mix <input type="checkbox"/> Feather		
	<b>COMFORT</b>	Standard Comfort <input checked="" type="checkbox"/>	Firm Comfort <input checked="" type="checkbox"/>			
	<b>FUNCTION</b>	Bed <input type="checkbox"/>	Electric motion <input checked="" type="checkbox"/>	Motion <input checked="" type="checkbox"/>	Recliner <input checked="" type="checkbox"/>	Sliding <input type="checkbox"/>
	<b>VISUAL APPEARANCE*</b>	Low <input checked="" type="checkbox"/>	Medium <input type="checkbox"/>	High <input type="checkbox"/>		
	<b>LEGS</b>	Wood <input checked="" type="checkbox"/>	Metal <input type="checkbox"/>	Upholstered <input type="checkbox"/>	Plastic <input type="checkbox"/>	Castors <input type="checkbox"/>

VISUAL APPEARANCE

The product may reveal various wrinkles due to the combination of Elasticity of the covering, characteristics of the interior construction and the design of the product.



Products with Visual Appearance listed as High or Medium would require higher degree of care, where seats and back cushions may require fluffing and plumping more often than Products with Visual Appearance listed as Low.

NOTES

- Available in leather (TG only) or fabric.
- CUBICOMFORT™ Triple-Motion Technology is a registered trademark. It denotes a set of independent motion systems that activate the various elements of the sofa (seat, backrest, headrest and footrest) allowing each person to adjust their position of absolute comfort to the millimeter.
- Mech. 1: All in One Power Reclining mechanism simultaneously reclines the back and seat and footrest that allows you to reach a horizontal position for unlimited relaxation.
- Mech. 2: Power Lumbar Support allows you to adjust the lower part of the backrest by increasing or decreasing the pressure for a better back support.
- Mech. 3: Power Adjustable Headrest which allows you to recline the headrest forward with millimetric precision and reach a perfect relaxation position for great comfort.
- The multifunctional console, with a full wooden finish, features a spacious tabletop, a storage drawer, a built-in USB port, and connectors for adding optional features—blending style, convenience, and versatility. The console can be ordered with its own version code 821 or 823. For order entry please use XXX for alias code and finishing code ST49 ash brown or ST50 ash blonde.
- Switch Panel Pocket: A fully upholstered pocket housing the switch panel enhances the visual appeal of the model, offering a distinctive aesthetic element.
- A battery pack can be ordered with its own version code 830. For order entry please use XX for category and XXX for cover code. In order to optimize the duration of the battery, it is suggested to order one per each motion seat.

## NOTES

---

- Feet available in wood finishings 09 (Walnut) / 18 (Wengè)



■ Vers.



■ Vers.



■ Vers.



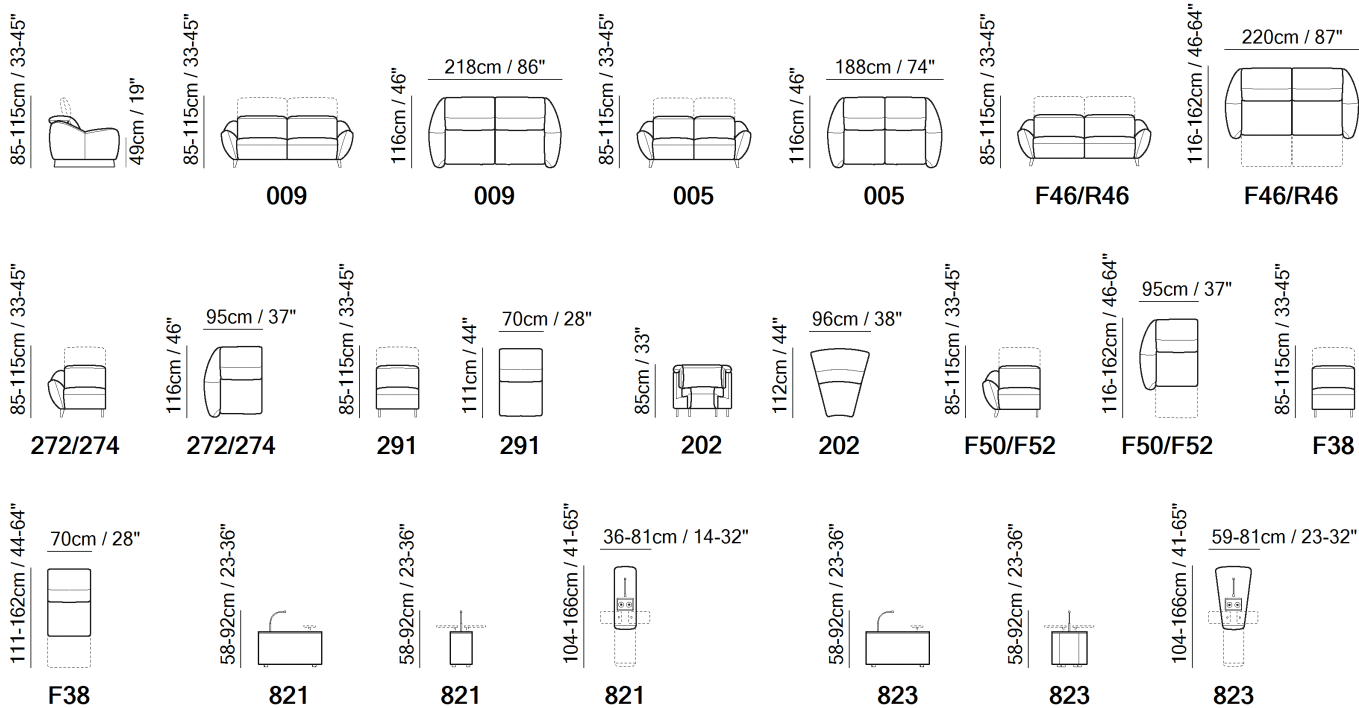

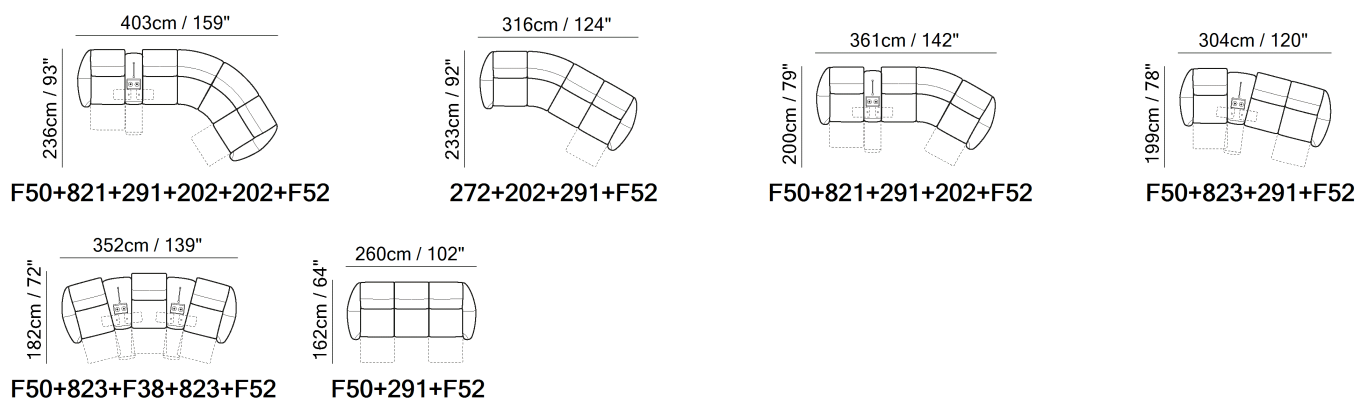

SCHEMATICS



COMPOSITION EXAMPLES



TECHNICAL INFORMATION

	<b>COVERING</b>	Leather <input checked="" type="checkbox"/>	Soft Cover <input checked="" type="checkbox"/>				
	<b>FILLING</b>	Arms	<input type="checkbox"/> Fiber <input type="checkbox"/> Foam <input type="checkbox"/> Feather/Fiber Mix <input type="checkbox"/> Feather	Seat cushion	<input type="checkbox"/> Fiber <input type="checkbox"/> Foam <input type="checkbox"/> Feather/Fiber Mix <input type="checkbox"/> Feather	Back cushion	<input type="checkbox"/> Fiber <input type="checkbox"/> Foam <input type="checkbox"/> Feather/Fiber Mix <input type="checkbox"/> Feather
	<b>COMFORT</b>	Firm Comfort <input type="checkbox"/>	Standard Comfort <input checked="" type="checkbox"/>				
	<b>FUNCTION</b>	Bed <input type="checkbox"/>	Electric motion <input type="checkbox"/>	Motion <input checked="" type="checkbox"/>	Recliner <input type="checkbox"/>	Sliding <input type="checkbox"/>	
	<b>VISUAL APPEARANCE*</b>	Low <input type="checkbox"/>	Medium <input checked="" type="checkbox"/>	High <input type="checkbox"/>			
	<b>LEGS</b>	Metal <input type="checkbox"/>	Wood <input type="checkbox"/>	Castors <input type="checkbox"/>	Plastic <input type="checkbox"/>	Upholstered <input type="checkbox"/>	

VISUAL APPEARANCE

The product may reveal various wrinkles due to the combination of Elasticity of the covering, characteristics of the interior construction and the design of the product.



Products with Visual Appearance listed as High or Medium would require higher degree of care, where seats and back cushions may require fluffing and plumping more often than Products with Visual Appearance listed as Low.

NOTES

- Available in leather (TG only) or fabric.
- By distributing weight evenly across all pressure points, the zero-gravity power motion system makes you feel weightless. It takes the pressure off your spine and can promote circulation in the legs.  
The definition of Zero Gravity Reclining is the ability for your heart to be resting above your feet which provides proven health benefits.
- ZERO GRAVITY™ DUAL POWER MOTION: a unique power motion system that separately and independently activates the different functions, to adjust the seat recliner and the headrest, allowing you to reach extreme comfort in a “zero gravity” position.
- Switch #1: All in One Power Reclining mechanism that simultaneously reclines the back, activates a “comfort tilt” of the seat and a full extension of the footrest, taking you to a “zero gravity” position that will make you experience a total and unparalleled relaxation.
- Switch #2: Power Adjustable Headrest which allows you to recline the headrest forward with millimetric precision to support you with a perfect and proper posture.
- «DualPower Motion» mechanism “All -in-One” power motion system offers a seamless, continuous sequence of functions designed to provide optimum comfort:
  - it starts by adjusting the headrest
  - then reclines both the seat and backrest,
  - and concludes with a final forward tilt of the headrest.

NOTES

---

- The dual power motion feature is controlled via concealed smart touch buttons positioned between the seat and the armrest.

Footboard closure design: The specific design of the footboard closure with its extended flap further contributes to optimal relaxation while also providing a spacious open base beneath the sofa, making cleaning easier.

- The multifunctional console, with a full wooden finish, features a spacious tabletop, a storage drawer, a built-in USB port, and connectors for adding optional features—blending style, convenience, and versatility. The console can be ordered with its own version code 821 or 823. For order entry please use XXX for alias code and finishing code ST49 ash brown or ST50 ash blonde.
- A battery pack can be ordered with its own version code 830. For order entry please use XX for category and XXX for cover code. In order to optimize the duration of the battery, it is suggested to order one per each motion seat.
- Internal wooden frame.
- Feet will be in a bag inside the package and requires assembling.
- Packaging: Cardboard wrap.
- Feet are available in metal leg finishings (79 matt black or 70 brushed brass)



■ Vers. 003



■ Vers. 003







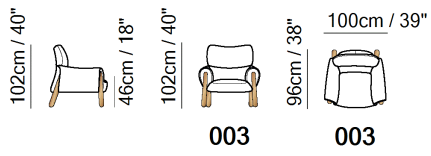

■ Vers. 003

SCHEMATICS

---



TECHNICAL INFORMATION

	<b>COVERING</b>	Leather <input checked="" type="checkbox"/>	Soft Cover <input checked="" type="checkbox"/>		
	<b>FILLING</b>	Arms	<input type="checkbox"/> Fiber <input type="checkbox"/> Foam <input type="checkbox"/> Feather/Fiber Mix <input type="checkbox"/> Feather	Seat cushion	<input type="checkbox"/> Fiber <input type="checkbox"/> Foam <input type="checkbox"/> Feather/Fiber Mix <input type="checkbox"/> Feather
				Back cushion	<input type="checkbox"/> Fiber <input type="checkbox"/> Foam <input type="checkbox"/> Feather/Fiber Mix <input type="checkbox"/> Feather
	<b>COMFORT</b>	Standard Comfort <input checked="" type="checkbox"/>	Firm Comfort <input type="checkbox"/>		
	<b>FUNCTION</b>	Bed <input type="checkbox"/>	Electric motion <input type="checkbox"/>	Motion <input type="checkbox"/>	Recliner <input type="checkbox"/>
					Sliding <input type="checkbox"/>
	<b>VISUAL APPEARANCE*</b>	Low <input type="checkbox"/>	Medium <input checked="" type="checkbox"/>	High <input type="checkbox"/>	
	<b>LEGS</b>	Wood <input checked="" type="checkbox"/>	Metal <input type="checkbox"/>	Upholstered <input type="checkbox"/>	Plastic <input type="checkbox"/>
					Castors <input type="checkbox"/>

VISUAL APPEARANCE

The product may reveal various wrinkles due to the combination of Elasticity of the covering, characteristics of the interior construction and the design of the product.



Products with Visual Appearance listed as High or Medium would require higher degree of care, where seats and back cushions may require fluffing and plumping more often than Products with Visual Appearance listed as Low.

NOTES

- A distinctive chair that gets its peculiarity from the organiz wooden legs, currently very trendy.
- Available in leather (TG only) or fabric.
- Seat and back cushions are fixed to the frame, whilst headrest is not.
- With Feet Assembled (the model will be loaded with feet already mounted on the sofa).
- Feet are available in wooden finishings (49) Ash Brown, (50) Ash Blonde and (65) Ash Grey.
- Height of the chair from the floor: 24 cm

**NOTES**

---



■ Vers.



■ Vers.



■ Vers.

SCHEMATICS

---

108cm / 43"  
  
47cm / 19"

108cm / 43"  
  
244







91-114cm / 36-45"  
  
93cm / 37"  
244

45cm / 18"  
  
014

45cm / 18"  
  
014

45cm / 18"  
  
59cm / 23"  
014

TECHNICAL INFORMATION

	<b>COVERING</b>	Leather <input checked="" type="checkbox"/>	Soft Cover <input checked="" type="checkbox"/>				
	<b>FILLING</b>	Arms	<input type="checkbox"/> Fiber <input type="checkbox"/> Foam <input type="checkbox"/> Feather/Fiber Mix <input type="checkbox"/> Feather	Seat cushion	<input type="checkbox"/> Fiber <input type="checkbox"/> Foam <input type="checkbox"/> Feather/Fiber Mix <input type="checkbox"/> Feather	Back cushion	<input type="checkbox"/> Fiber <input type="checkbox"/> Foam <input type="checkbox"/> Feather/Fiber Mix <input type="checkbox"/> Feather
	<b>COMFORT</b>	Firm Comfort <input type="checkbox"/>	Standard Comfort <input checked="" type="checkbox"/>				
	<b>FUNCTION</b>	Bed <input type="checkbox"/>	Electric motion <input type="checkbox"/>	Motion <input type="checkbox"/>	Recliner <input checked="" type="checkbox"/>	Sliding <input type="checkbox"/>	
	<b>VISUAL APPEARANCE*</b>	Low <input type="checkbox"/>	Medium <input checked="" type="checkbox"/>	High <input type="checkbox"/>			
	<b>LEGS</b>	Metal <input checked="" type="checkbox"/>	Wood <input type="checkbox"/>	Castors <input type="checkbox"/>	Plastic <input type="checkbox"/>	Upholstered <input type="checkbox"/>	

VISUAL APPEARANCE

The product may reveal various wrinkles due to the combination of Elasticity of the covering, characteristics of the interior construction and the design of the product.



Products with Visual Appearance listed as High or Medium would require higher degree of care, where seats and back cushions may require fluffing and plumping more often than Products with Visual Appearance listed as Low.

NOTES

- Available in leather (TG only) or fabric.
- A metal lever located between the armrest and seat allows you to recline the backrest throughout a straightforward “push-back” mechanism. This lever lets you lock or release the backrest position, enabling you to adjust your relaxing position. For enhanced comfort, pairing this with the footrest ottoman provides full-body support for a truly relaxing experience.
- Tight Seat Cushion (the seat cushions of the models are fixed to the frame)
- Tight Back Cushion (the back cushions of the models are fixed to the frame)
- Packaging: Cardboard wrap.
- Metal base available in finishing 79 (Matte Black)
- Metal base height from floor 19 cm / Ottoman height 22 cm

NOTES

---



■ Vers.



■ Vers.







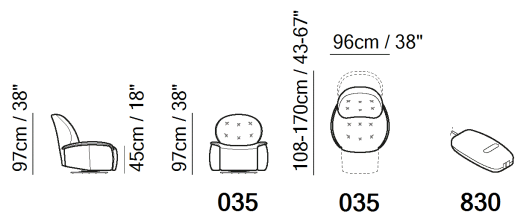

■ Vers.

SCHEMATICS

---



TECHNICAL INFORMATION

	<b>COVERING</b>	Leather <input checked="" type="checkbox"/>	Soft Cover <input checked="" type="checkbox"/>		
	<b>FILLING</b>	Arms	<input type="checkbox"/> Fiber <input type="checkbox"/> Foam <input type="checkbox"/> Feather/Fiber Mix <input type="checkbox"/> Feather	Seat cushion	<input type="checkbox"/> Fiber <input type="checkbox"/> Foam <input type="checkbox"/> Feather/Fiber Mix <input type="checkbox"/> Feather
				Back cushion	<input type="checkbox"/> Fiber <input type="checkbox"/> Foam <input type="checkbox"/> Feather/Fiber Mix <input type="checkbox"/> Feather
	<b>COMFORT</b>	Standard Comfort <input checked="" type="checkbox"/>	Firm Comfort <input type="checkbox"/>		
	<b>FUNCTION</b>	Bed <input type="checkbox"/>	Electric motion <input type="checkbox"/>	Motion <input type="checkbox"/>	Recliner <input checked="" type="checkbox"/>
					Sliding <input type="checkbox"/>
	<b>VISUAL APPEARANCE*</b>	Low <input checked="" type="checkbox"/>	Medium <input type="checkbox"/>	High <input type="checkbox"/>	
	<b>LEGS</b>	Wood <input type="checkbox"/>	Metal <input type="checkbox"/>	Upholstered <input type="checkbox"/>	Plastic <input type="checkbox"/>
					Castors <input type="checkbox"/>

VISUAL APPEARANCE

The product may reveal various wrinkles due to the combination of Elasticity of the covering, characteristics of the interior construction and the design of the product.



Products with Visual Appearance listed as High or Medium would require higher degree of care, where seats and back cushions may require fluffing and plumping more often than Products with Visual Appearance listed as Low.

NOTES

- Model is available with a swivel chair version (035) with rocking function and power recliner.
- Available in leather (TG only) or fabric.
- Smart touch buttons to activate power reclining functions positioned on the side of the seating
- When the power reclining mechanism is engaged, a mechanical lock activates to prevent both the swivel and rocking movements
- Equipped with a power mechanism enabling full recline of the seat, backrest, and footrest to ensure optimal comfort.
- A battery pack can be ordered with its own version code 830. For order entry please use XX for category and XXX for cover code. In order to optimize the duration of the battery, it is suggested to order one per each motion seat.

NOTES

---



■ Vers.



■ Vers.



■ Vers.

SCHEMATICS

---

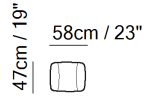
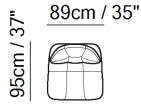

066







066

014

014

014

TECHNICAL INFORMATION

	<b>COVERING</b>	Leather <input checked="" type="checkbox"/>	Soft Cover <input checked="" type="checkbox"/>				
	<b>FILLING</b>	Arms	<input type="checkbox"/> Fiber <input type="checkbox"/> Foam <input type="checkbox"/> Feather/Fiber Mix <input type="checkbox"/> Feather	Seat cushion	<input type="checkbox"/> Fiber <input type="checkbox"/> Foam <input type="checkbox"/> Feather/Fiber Mix <input type="checkbox"/> Feather	Back cushion	<input type="checkbox"/> Fiber <input type="checkbox"/> Foam <input type="checkbox"/> Feather/Fiber Mix <input type="checkbox"/> Feather
	<b>COMFORT</b>	Firm Comfort <input type="checkbox"/>	Standard Comfort <input checked="" type="checkbox"/>				
	<b>FUNCTION</b>	Bed <input type="checkbox"/>	Electric motion <input type="checkbox"/>	Motion <input type="checkbox"/>	Recliner <input type="checkbox"/>	Sliding <input type="checkbox"/>	
	<b>VISUAL APPEARANCE*</b>	Low <input type="checkbox"/>	Medium <input checked="" type="checkbox"/>	High <input type="checkbox"/>			
	<b>LEGS</b>	Metal <input checked="" type="checkbox"/>	Wood <input type="checkbox"/>	Castors <input type="checkbox"/>	Plastic <input type="checkbox"/>	Upholstered <input type="checkbox"/>	

VISUAL APPEARANCE

The product may reveal various wrinkles due to the combination of Elasticity of the covering, characteristics of the interior construction and the design of the product.



Products with Visual Appearance listed as High or Medium would require higher degree of care, where seats and back cushions may require fluffing and plumping more often than Products with Visual Appearance listed as Low.

NOTES

- Available in leather (TG only) or fabric.
- Metal base available in finishing 79 (Matte Black)
- Features a swivel base with also a footrest ottoma(vers. 014) n that can be paired to provide feet and leg support, ensuring optimal comfort.
- Metal base height from floor 19 cm / Ottoman height 22 cm

NOTES

---



■ Vers.



■ Vers.



■ Vers.



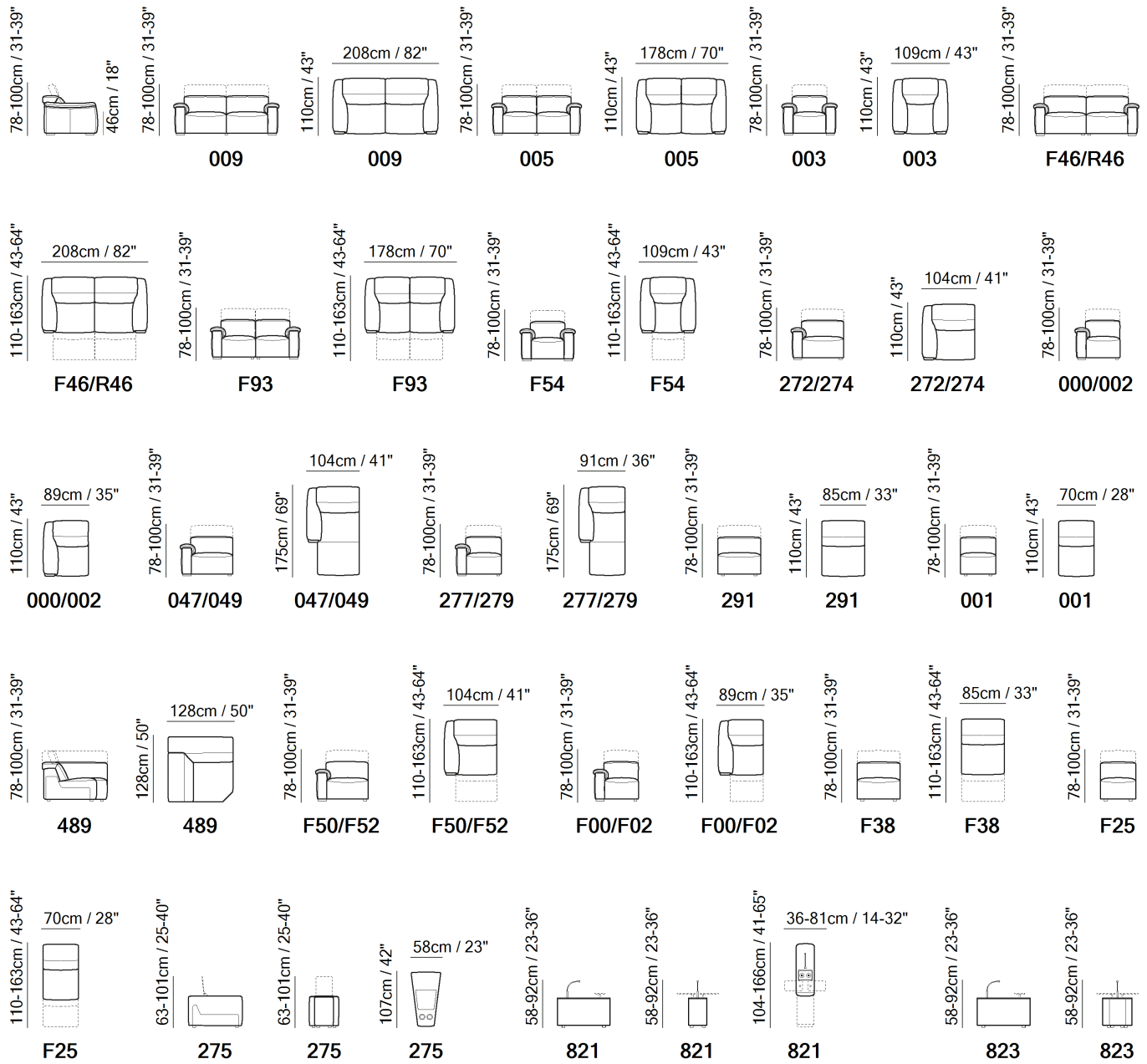

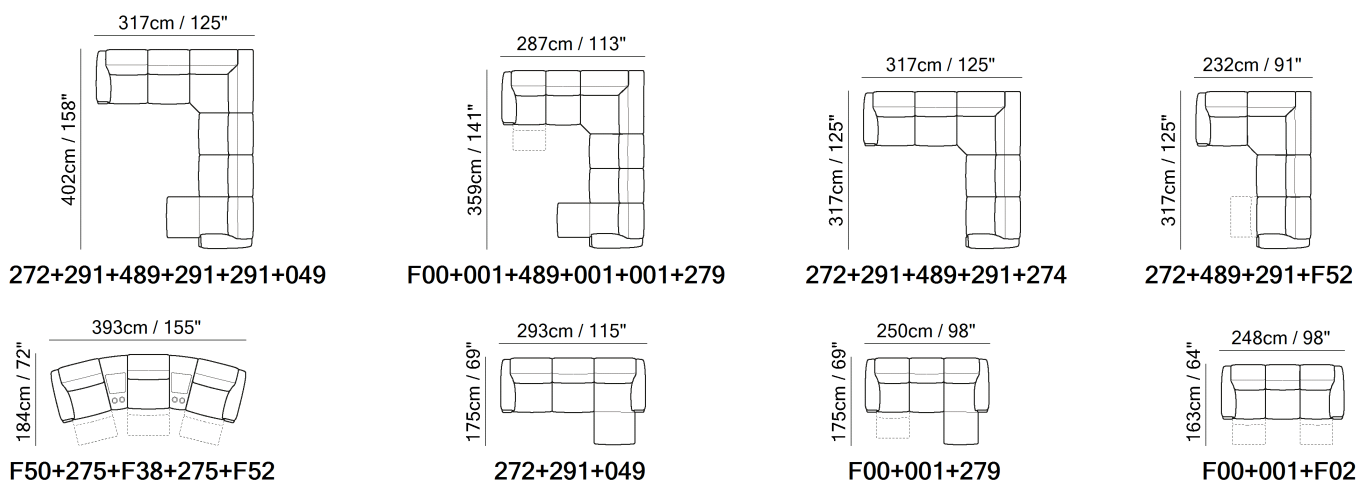

SCHEMATICS



COMPOSITION EXAMPLES



TECHNICAL INFORMATION

	<b>COVERING</b>	Leather <input checked="" type="checkbox"/>	Soft Cover <input checked="" type="checkbox"/>				
	<b>FILLING</b>	Arms	<input type="checkbox"/> Fiber <input type="checkbox"/> Foam <input type="checkbox"/> Feather/Fiber Mix <input type="checkbox"/> Feather	Seat cushion	<input type="checkbox"/> Fiber <input type="checkbox"/> Foam <input type="checkbox"/> Feather/Fiber Mix <input type="checkbox"/> Feather	Back cushion	<input type="checkbox"/> Fiber <input type="checkbox"/> Foam <input type="checkbox"/> Feather/Fiber Mix <input type="checkbox"/> Feather
	<b>COMFORT</b>	Standard Comfort <input checked="" type="checkbox"/>	Firm Comfort <input checked="" type="checkbox"/>				
	<b>FUNCTION</b>	Bed <input type="checkbox"/>	Electric motion <input type="checkbox"/>	Motion <input checked="" type="checkbox"/>	Recliner <input checked="" type="checkbox"/>	Sliding <input type="checkbox"/>	
	<b>VISUAL APPEARANCE*</b>	Low <input type="checkbox"/>	Medium <input checked="" type="checkbox"/>	High <input type="checkbox"/>			
	<b>LEGS</b>	Wood <input checked="" type="checkbox"/>	Metal <input type="checkbox"/>	Upholstered <input type="checkbox"/>	Plastic <input type="checkbox"/>	Castors <input type="checkbox"/>	

VISUAL APPEARANCE

The product may reveal various wrinkles due to the combination of Elasticity of the covering, characteristics of the interior construction and the design of the product.



Products with Visual Appearance listed as High or Medium would require higher degree of care, where seats and back cushions may require fluffing and plumping more often than Products with Visual Appearance listed as Low.

NOTES

- Available in leather (TG only) or fabric.
- Model is available with contrast welt (or any another decorative detail such as a band under arm cushion) to be entered as second covering in the same category.
- FABRIC: In fabric contrast welt (as well as any another decorative detail such as a band under arm cushion or backrest or inserts) can be made with any color of art. Le Mans.
- Dual power motion recliner: headrest and footrest
- Thanks to ZeroWall mechanism, seat and back cushions can be reclined at a great length without moving sofa away from the wall.
- Power adjustable headrest that can be adjusted separately for optimum head support (Manual on stationary versions).
- The armless relax seats have an upholstered switch flap on the side that can be easily hidden between the seats to activate the mechanism.
- Functions are operated by the power switch located on outside panel of the arm which also allocates a USB charging port.
- The switch for version chair without arms with mechanism (versions 338/F38/F25), is on the left hand side of the seat (front view)

## NOTES

---

- The multifunctional console, with a full wooden finish, features a spacious tabletop, a storage drawer, a built-in USB port, and connectors for adding optional features—blending style, convenience, and versatility. The console can be ordered with its own version code 821 or 823. For order entry please use XXX for alias code and finishing code ST49 ash brown or ST50 ash blonde.
- A battery pack can be ordered with its own version code 830. For order entry please use XX for category and XXX for cover code. In order to optimize the duration of the battery, it is suggested to order one per each motion seat.
- Packaging: plastic wrap for stationary versions and cardboard box for motion/sofabed versions
- Feet available in wood finishings 09 (Walnut) / 18 (Wengè)
- Feet height 4,0 cm



■ Vers. 009



■ Vers. 018+100



■ Vers. 018+032+073



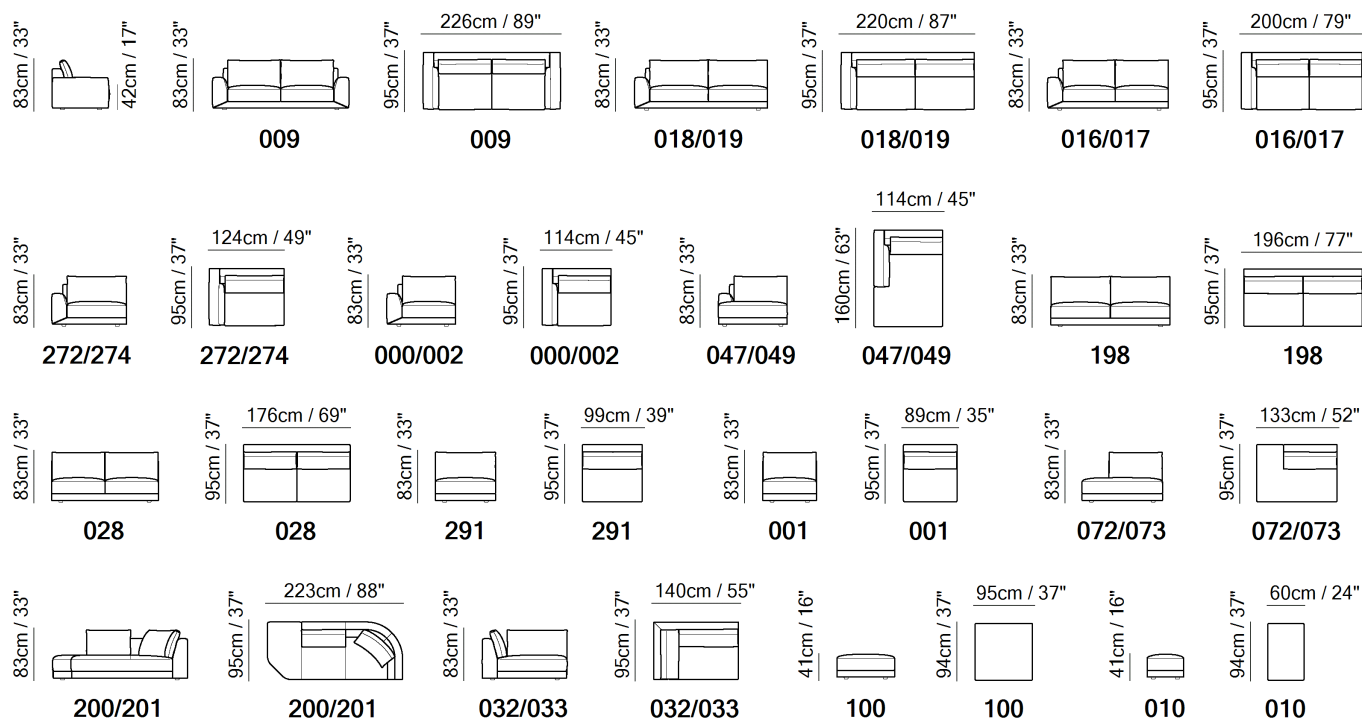

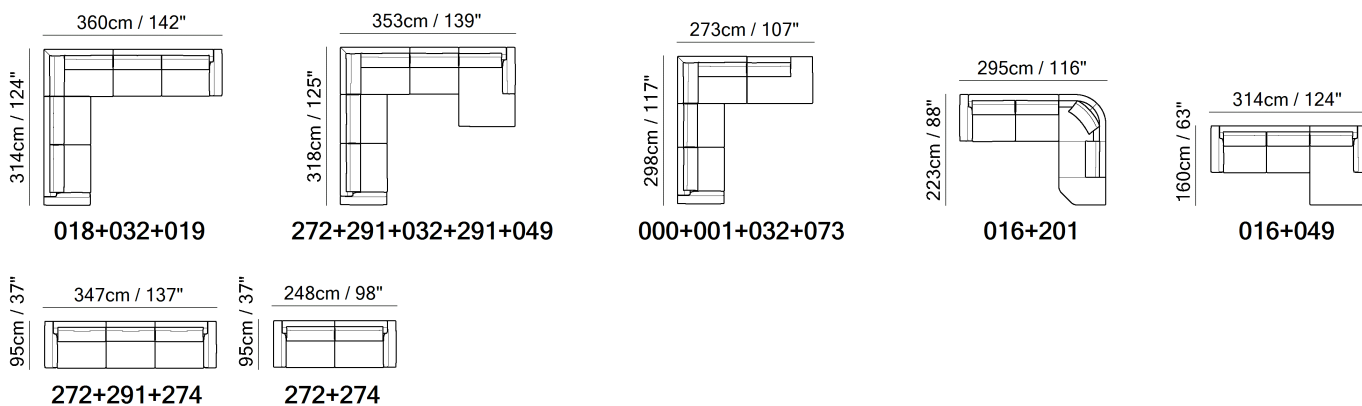

SCHEMATICS



COMPOSITION EXAMPLES



TECHNICAL INFORMATION

	<b>COVERING</b>	Leather <input checked="" type="checkbox"/>	Soft Cover <input checked="" type="checkbox"/>			
	<b>FILLING</b>	Arms <input type="checkbox"/> Fiber <input checked="" type="checkbox"/> Foam <input type="checkbox"/> Feather/Fiber Mix <input type="checkbox"/> Feather	Seat cushion <input type="checkbox"/> Fiber <input checked="" type="checkbox"/> Foam <input type="checkbox"/> Feather/Fiber Mix <input type="checkbox"/> Feather	Back cushion <input type="checkbox"/> Fiber <input checked="" type="checkbox"/> Foam <input type="checkbox"/> Feather/Fiber Mix <input type="checkbox"/> Feather		
	<b>COMFORT</b>	Firm Comfort <input checked="" type="checkbox"/>	Standard Comfort <input checked="" type="checkbox"/>			
	<b>FUNCTION</b>	Bed <input type="checkbox"/>	Electric motion <input type="checkbox"/>	Motion <input type="checkbox"/>	Recliner <input type="checkbox"/>	Sliding <input type="checkbox"/>
	<b>VISUAL APPEARANCE*</b>	Low <input checked="" type="checkbox"/>	Medium <input type="checkbox"/>	High <input type="checkbox"/>		
	<b>LEGS</b>	Metal <input type="checkbox"/>	Wood <input type="checkbox"/>	Castors <input type="checkbox"/>	Plastic <input checked="" type="checkbox"/>	Upholstered <input type="checkbox"/>

VISUAL APPEARANCE

The product may reveal various wrinkles due to the combination of Elasticity of the covering, characteristics of the interior construction and the design of the product.



Products with Visual Appearance listed as High or Medium would require higher degree of care, where seats and back cushions may require fluffing and plumping more often than Products with Visual Appearance listed as Low.

NOTES

- The model Kartun with model code X194 is available with larger back cushions (same length of the seat cushions as C194)
- In leather, due to the wide dimensions of its elements, in order to avoid cuts on the seat and back cushions and to also keep its original clean and linear look, model will be available starting from cat. 20.
- To allow modularity, the single elements can be put together thanks to the rubber stops under the legs.
- Two ottomans available (square and rectangular) to be also used as terminal, chaise-longue and additional seat.
- All versions are finished on the sides and come without connectors to be used as single elements.
- Feet will be in a bag inside the package and requires assembling.
- Packaging: Cardboard box. Only ottomans are wrapped in plastic bag.

NOTES

---



■ Vers. 767+436+766



■ Vers. 768



■ Vers. 763+753+673+755



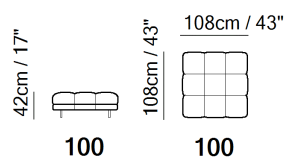
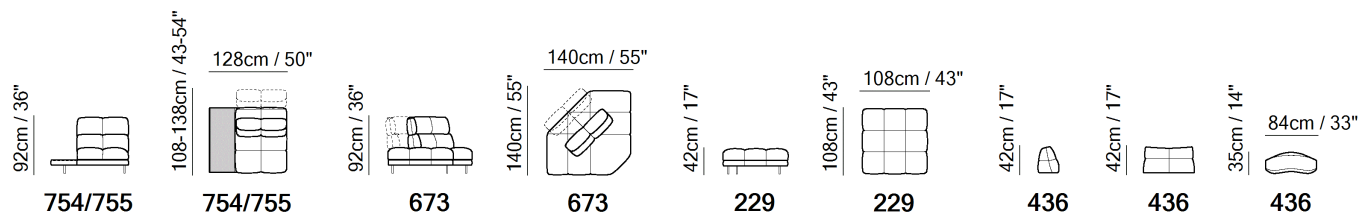
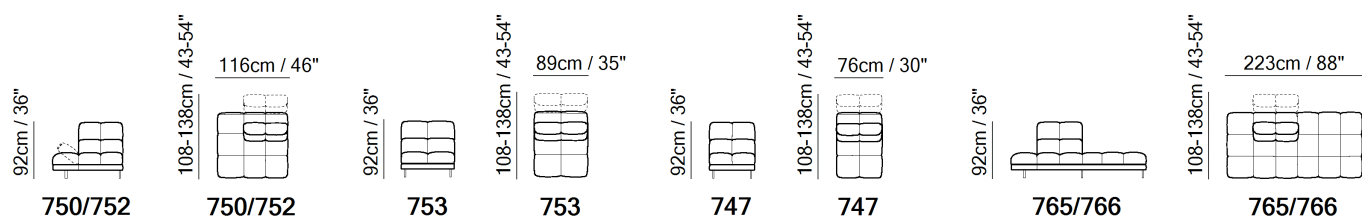
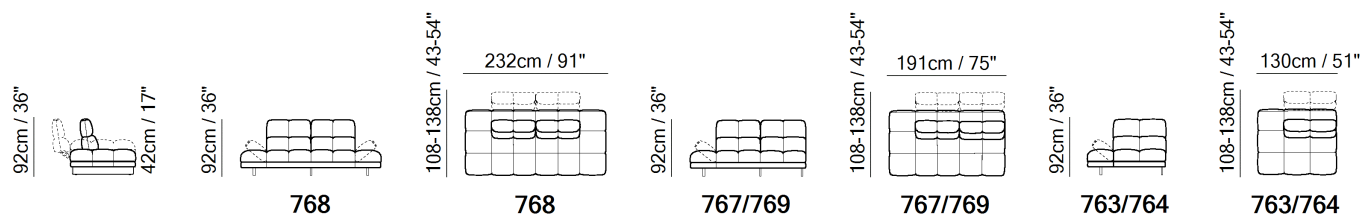

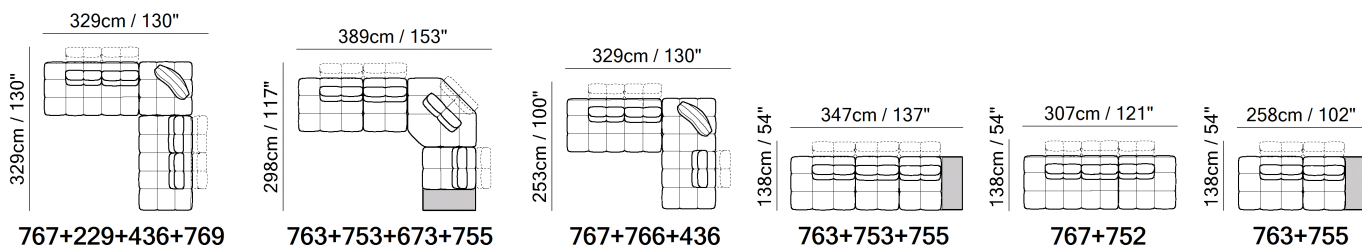

SCHEMATICS



COMPOSITION EXAMPLES



TECHNICAL INFORMATION

	<b>COVERING</b>	Leather <input checked="" type="checkbox"/>					
	<b>FILLING</b>	Arms	<input type="checkbox"/> Fiber	Seat cushion	<input type="checkbox"/> Fiber	Back cushion	<input type="checkbox"/> Fiber
			<input checked="" type="checkbox"/> Foam		<input checked="" type="checkbox"/> Foam		<input checked="" type="checkbox"/> Foam
			<input type="checkbox"/> Feather/Fiber Mix		<input type="checkbox"/> Feather/Fiber Mix		<input type="checkbox"/> Feather/Fiber Mix
			<input type="checkbox"/> Feather		<input type="checkbox"/> Feather		<input type="checkbox"/> Feather
	<b>COMFORT</b>	Standard Comfort <input checked="" type="checkbox"/>	Firm Comfort <input checked="" type="checkbox"/>				
	<b>FUNCTION</b>	Bed <input type="checkbox"/>	Electric motion <input type="checkbox"/>	Motion <input type="checkbox"/>	Recliner <input type="checkbox"/>	Sliding <input type="checkbox"/>	
	<b>VISUAL APPEARANCE*</b>	Low <input type="checkbox"/>	Medium <input type="checkbox"/>	High <input checked="" type="checkbox"/>			
	<b>LEGS</b>	Wood <input type="checkbox"/>	Metal <input checked="" type="checkbox"/>	Upholstered <input type="checkbox"/>	Plastic <input type="checkbox"/>	Castors <input type="checkbox"/>	

VISUAL APPEARANCE

The product may reveal various wrinkles due to the combination of Elasticity of the covering, characteristics of the interior construction and the design of the product.



Products with Visual Appearance listed as High or Medium would require higher degree of care, where seats and back cushions may require fluffing and plumping more often than Products with Visual Appearance listed as Low.

NOTES

- LEATHER: Model available only in Top Grain leather
- Model Roma is available in fabric with code C257 and in leather with code X257. The versions of the models can be combined with each other.
- Manually adjustable backrest through a tilting mechanism: 2 positions, back and forth.
- Manually adjustable arm with ratchet mechanism.
- Versions 754/755 (large armless chair with left/right terminal and adj. backrest) include a ceramic side top on the terminal in jazz white finishing only.
- New modular sectional versions that allow compact configuration solutions by also combining new additional elements such as the “self-standing backrest”. This version has a carefully studied weight placed internally in its base. You can feel free to move it around and place it as needed on the seating surface to easily provide back support.
- 229 version to be used only as a corner while the 100 as a loose ottoman. These versions have same dimensions and look similar, but they differ from each other by the legs positioning.
- To facilitate delivery operations, the backrests will be disassembled and no longer attached to the structure. In the feet box, along with the feet assembly instructions, the backrest assembly instructions will also be included.
- Packaging: Cardboard wrap.
- Feet available in metal finishings 77 (Glossy Chromed) / 79 (Matte Black)

NOTES

---



■ Vers. 170+605+387+171



■ Vers. 170+605+387+171



■ Vers. 170+605+387+171



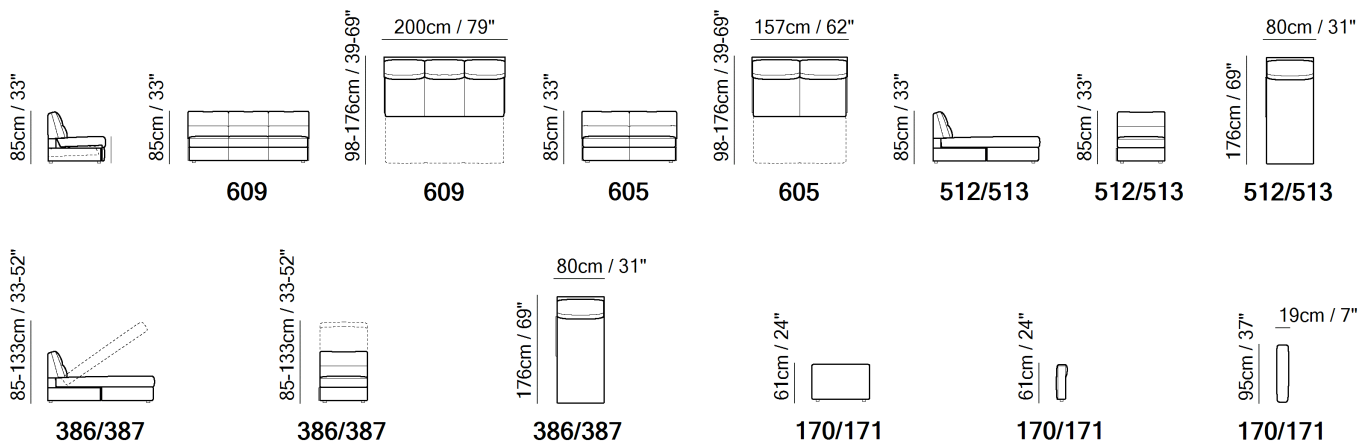

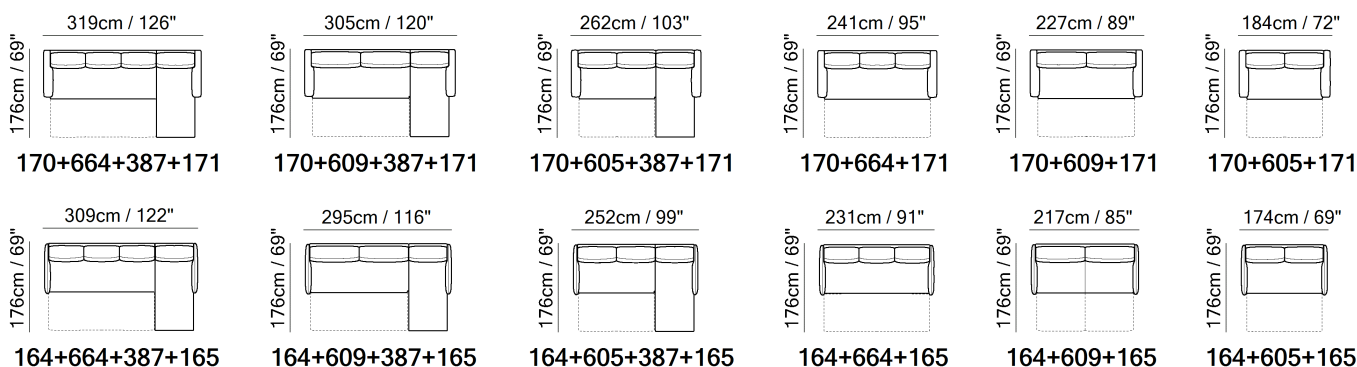

SCHEMATICS



COMPOSITION EXAMPLES



TECHNICAL INFORMATION

	<b>COVERING</b>	Soft Cover <input checked="" type="checkbox"/>					
	<b>FILLING</b>	Arms	<input type="checkbox"/> Fiber <input checked="" type="checkbox"/> Foam <input type="checkbox"/> Feather/Fiber Mix <input type="checkbox"/> Feather	Seat cushion	<input type="checkbox"/> Fiber <input checked="" type="checkbox"/> Foam <input type="checkbox"/> Feather/Fiber Mix <input type="checkbox"/> Feather	Back cushion	<input type="checkbox"/> Fiber <input checked="" type="checkbox"/> Foam <input type="checkbox"/> Feather/Fiber Mix <input type="checkbox"/> Feather
	<b>COMFORT</b>	Firm Comfort	Standard Comfort <input checked="" type="checkbox"/>				
	<b>FUNCTION</b>	Bed	Electric motion	Motion	Recliner	Sliding <input checked="" type="checkbox"/>	
	<b>VISUAL APPEARANCE*</b>	Low <input checked="" type="checkbox"/>	Medium <input type="checkbox"/>	High <input type="checkbox"/>			
	<b>LEGS</b>	Metal	Wood	Castors	Plastic	Upholstered	

VISUAL APPEARANCE

The product may reveal various wrinkles due to the combination of Elasticity of the covering, characteristics of the interior construction and the design of the product.



Products with Visual Appearance listed as High or Medium would require higher degree of care, where seats and back cushions may require fluffing and plumping more often than Products with Visual Appearance listed as Low.

NOTES

- 
- **EXTRACTIBLE SEAT MECHANISM:** This model has an extractible seat mechanism, that assisted by dedicated springs, allow you to swiftly pull-out an extra seating. This brings to a perfect leveled surface, that occasionally can make it become a bed. The mechanism feature doesn't require the removal of any seat nor back cushions. The extracted seat has the same comfort as the one provided when in "sofa" mode (with mechanism closed).
- **Packaging:** Cardboard wrap.

NOTES

---



■ Vers. 272+045+291+F52



■ Vers. 272+045+291+F52



■ Vers. 272+045+291+F52



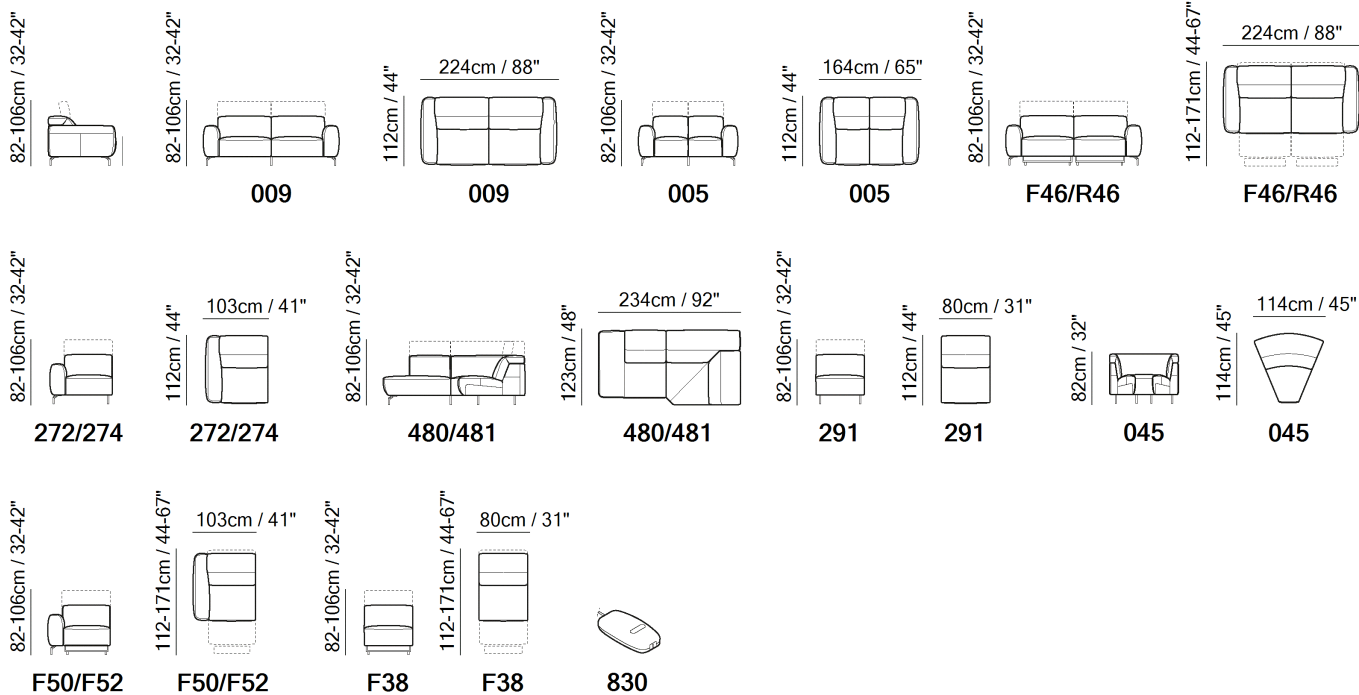

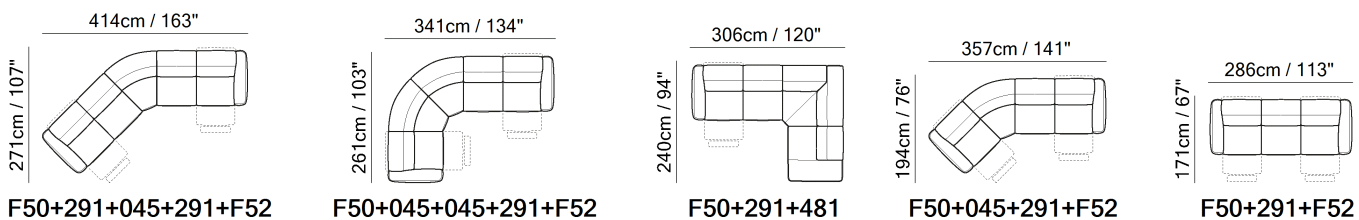

SCHEMATICS



COMPOSITION EXAMPLES



TECHNICAL INFORMATION

	<b>COVERING</b>	Leather <input checked="" type="checkbox"/>	Soft Cover <input checked="" type="checkbox"/>				
	<b>FILLING</b>	Arms	<input type="checkbox"/> Fiber <input type="checkbox"/> Foam <input type="checkbox"/> Feather/Fiber Mix <input type="checkbox"/> Feather	Seat cushion	<input type="checkbox"/> Fiber <input type="checkbox"/> Foam <input type="checkbox"/> Feather/Fiber Mix <input type="checkbox"/> Feather	Back cushion	<input type="checkbox"/> Fiber <input type="checkbox"/> Foam <input type="checkbox"/> Feather/Fiber Mix <input type="checkbox"/> Feather
	<b>COMFORT</b>	Standard Comfort <input checked="" type="checkbox"/>	Firm Comfort <input type="checkbox"/>				
	<b>FUNCTION</b>	Bed <input type="checkbox"/>	Electric motion <input type="checkbox"/>	Motion <input checked="" type="checkbox"/>	Recliner <input type="checkbox"/>	Sliding <input type="checkbox"/>	
	<b>VISUAL APPEARANCE*</b>	Low <input checked="" type="checkbox"/>	Medium <input type="checkbox"/>	High <input type="checkbox"/>			
	<b>LEGS</b>	Wood <input type="checkbox"/>	Metal <input checked="" type="checkbox"/>	Upholstered <input type="checkbox"/>	Plastic <input type="checkbox"/>	Castors <input type="checkbox"/>	

VISUAL APPEARANCE

The product may reveal various wrinkles due to the combination of Elasticity of the covering, characteristics of the interior construction and the design of the product.



Products with Visual Appearance listed as High or Medium would require higher degree of care, where seats and back cushions may require fluffing and plumping more often than Products with Visual Appearance listed as Low.

NOTES

- Available in leather (TG only) or fabric.
- By distributing weight evenly across all pressure points, the zero-gravity power motion system makes you feel weightless. It takes the pressure off your spine and can promote circulation in the legs.  
The definition of Zero Gravity Reclining is the ability for your heart to be resting above your feet which provides proven health benefits.
- ZERO GRAVITY™ DUAL POWER MOTION: a unique power motion system that separately and independently activates the different functions, to adjust the seat recliner and the headrest, allowing you to reach extreme comfort in a “zero gravity” position.
- Switch #1: All in One Power Reclining mechanism that simultaneously reclines the back, activates a “comfort tilt” of the seat and a full extension of the footrest, taking you to a “zero gravity” position that will make you experience a total and unparalleled relaxation.
- Switch #2: Power Adjustable Headrest which allows you to recline the headrest forward with millimetric precision to support you with a perfect and proper posture.
- Functions are operated by the power switch located on outside panel of the arm which also allocates a USB charging port.
- A battery pack can be ordered with its own version code 830. For order entry please use XX for category and XXX for cover code. In order to optimize the duration of the battery, it is suggested to order one per each motion seat.
- Internal wooden frame.

## NOTES

---

- Feet will be in a bag inside the package and requires assembling.
- Packaging: Cardboard wrap.
- Feet available in metal finishings 77 (Glossy Chromed) / 79 (Matte Black) / 59 (Grey)



■ Vers. 450+291+274



■ Vers. 450+291+274



■ Vers.



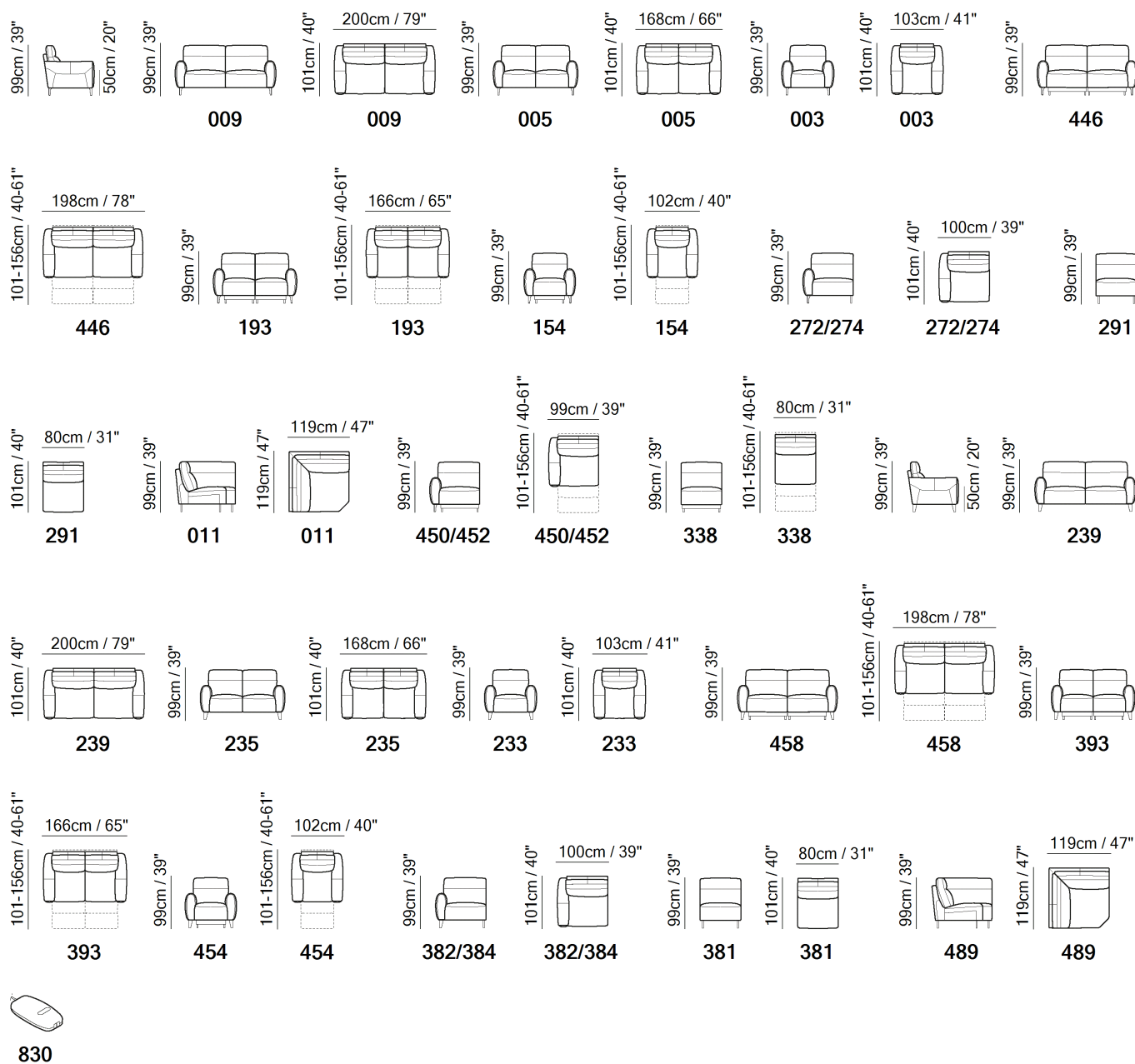

SCHEMATICS

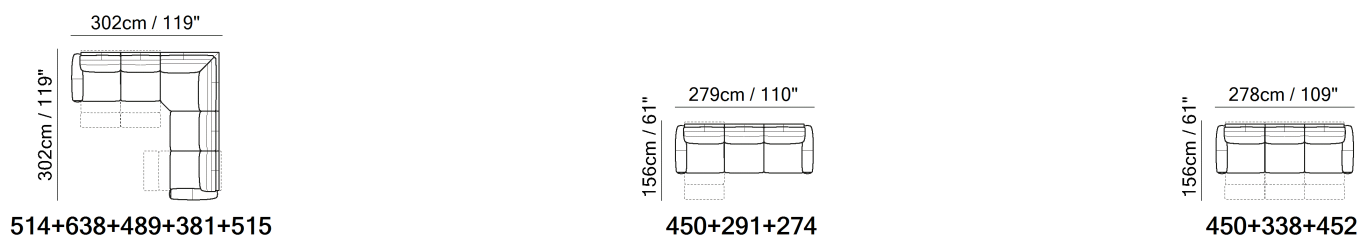

COMPOSITION EXAMPLES



TECHNICAL INFORMATION

	<b>COVERING</b>	Leather <input checked="" type="checkbox"/>	Soft Cover <input checked="" type="checkbox"/>				
	<b>FILLING</b>	Arms	<input type="checkbox"/> Fiber <input type="checkbox"/> Foam <input type="checkbox"/> Feather/Fiber Mix <input type="checkbox"/> Feather	Seat cushion	<input type="checkbox"/> Fiber <input type="checkbox"/> Foam <input type="checkbox"/> Feather/Fiber Mix <input type="checkbox"/> Feather	Back cushion	<input type="checkbox"/> Fiber <input type="checkbox"/> Foam <input type="checkbox"/> Feather/Fiber Mix <input type="checkbox"/> Feather
	<b>COMFORT</b>	Firm Comfort <input checked="" type="checkbox"/>	Standard Comfort <input checked="" type="checkbox"/>				
	<b>FUNCTION</b>	Bed <input type="checkbox"/>	Electric motion <input checked="" type="checkbox"/>	Motion <input checked="" type="checkbox"/>	Recliner <input checked="" type="checkbox"/>	Sliding <input type="checkbox"/>	
	<b>VISUAL APPEARANCE*</b>	Low <input checked="" type="checkbox"/>	Medium <input type="checkbox"/>	High <input type="checkbox"/>			
	<b>LEGS</b>	Metal <input type="checkbox"/>	Wood <input checked="" type="checkbox"/>	Castors <input type="checkbox"/>	Plastic <input type="checkbox"/>	Upholstered <input type="checkbox"/>	

VISUAL APPEARANCE

The product may reveal various wrinkles due to the combination of Elasticity of the covering, characteristics of the interior construction and the design of the product.



Products with Visual Appearance listed as High or Medium would require higher degree of care, where seats and back cushions may require fluffing and plumping more often than Products with Visual Appearance listed as Low.

NOTES

- Available in leather (TG only) or fabric.
- Single power mechanism with external switch on the side panel that activates recliner and includes an USB charging port.
- Headrest with manual adjustable tilt position available only on power motion versions.
- A battery pack can be ordered with its own version code 830. For order entry please use XX for category and XXX for cover code. In order to optimize the duration of the battery, it is suggested to order one per each motion seat.
- Tight Seat Cushion (the seat cushions of the models are fixed to the frame)
- Tight Back Cushion (the back cushions of the models are fixed to the frame)
- Internal wooden frame.
- With Feet Assembled (the model will be loaded with feet already mounted on the sofa).
- Packaging: Cardboard wrap.
- Metal feet are available in two different finishes: 79 matt black or 89 glossy silver.
- Second option versions have feet available in wood finishings 09 (Walnut) / 18 (Wengè)
- Feet height 15,0 cm

NOTES

---



■ Vers. 400+352+402



■ Vers. 400+352+402



■ Vers. 400+402





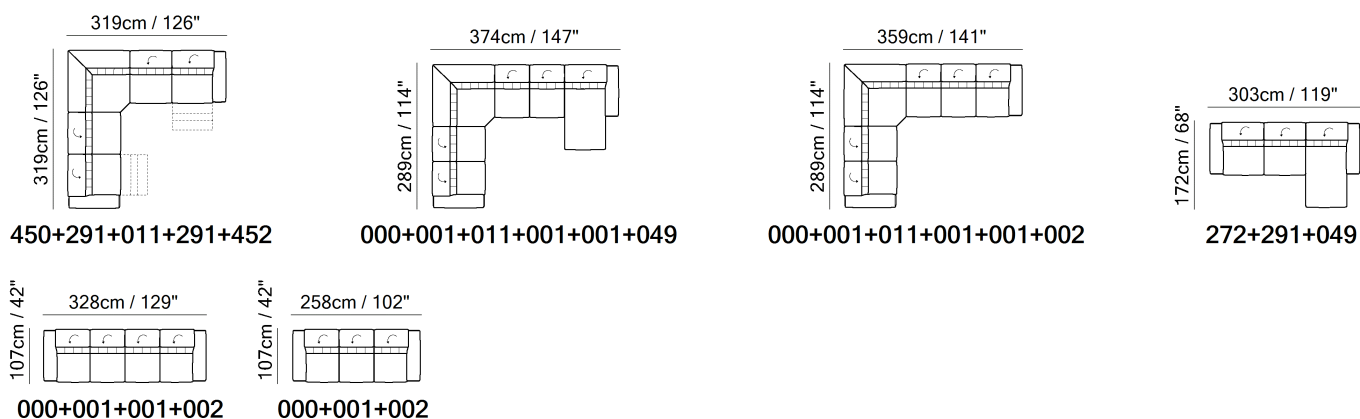

SCHEMATICS



COMPOSITION EXAMPLES



TECHNICAL INFORMATION

	<b>COVERING</b>	Leather <input checked="" type="checkbox"/>	Soft Cover <input checked="" type="checkbox"/>				
	<b>FILLING</b>	Arms	<input type="checkbox"/> Fiber <input checked="" type="checkbox"/> Foam <input type="checkbox"/> Feather/Fiber Mix <input type="checkbox"/> Feather	Seat cushion	<input type="checkbox"/> Fiber <input checked="" type="checkbox"/> Foam <input type="checkbox"/> Feather/Fiber Mix <input type="checkbox"/> Feather	Back cushion	<input type="checkbox"/> Fiber <input checked="" type="checkbox"/> Foam <input type="checkbox"/> Feather/Fiber Mix <input type="checkbox"/> Feather
	<b>COMFORT</b>	Standard Comfort <input checked="" type="checkbox"/>	Firm Comfort <input checked="" type="checkbox"/>				
	<b>FUNCTION</b>	Bed <input type="checkbox"/>	Electric motion <input checked="" type="checkbox"/>	Motion <input checked="" type="checkbox"/>	Recliner <input checked="" type="checkbox"/>	Sliding <input type="checkbox"/>	
	<b>VISUAL APPEARANCE*</b>	Low <input checked="" type="checkbox"/>	Medium <input type="checkbox"/>	High <input type="checkbox"/>			
	<b>LEGS</b>	Wood <input checked="" type="checkbox"/>	Metal <input type="checkbox"/>	Upholstered <input type="checkbox"/>	Plastic <input type="checkbox"/>	Castors <input type="checkbox"/>	

VISUAL APPEARANCE

The product may reveal various wrinkles due to the combination of Elasticity of the covering, characteristics of the interior construction and the design of the product.



Products with Visual Appearance listed as High or Medium would require higher degree of care, where seats and back cushions may require fluffing and plumping more often than Products with Visual Appearance listed as Low.

NOTES

- Available in leather (TG only) or fabric.
- Model is characterized by decorative "mocassin" stitching.
- Contrast stitching is available only with certain covers and option is managed directly in NARES.
- Standard versions have vertical stitchings on the back cushion; whilst second option versions of this model do not.
- Dual power motion recliner: headrest and footrest
- Functions are operated by the power switch located on outside panel of the arm which also allocates a USB charging port.
- A battery pack can be ordered with its own version code 830. For order entry please use XX for category and XXX for cover code. In order to optimize the duration of the battery, it is suggested to order one per each motion seat.
- Tight Seat Cushion (the seat cushions of the models are fixed to the frame)
- Tight Back Cushion (the back cushions of the models are fixed to the frame)
- No Leather/Fabric Side (the sectional pieces have the side covered with lining and not leather nor fabric)
- Internal wooden frame.
- Feet will be in a bag inside the package and requires assembling.

## NOTES

---

- Packaging: plastic wrap for stationary versions and cardboard box for motion/sofabed versions
- Feet available in wood finishings 09 (Walnut) / 18 (Wengè)
- Feet height 5,0 cm