



■ Vers. L01



■ Vers. L01





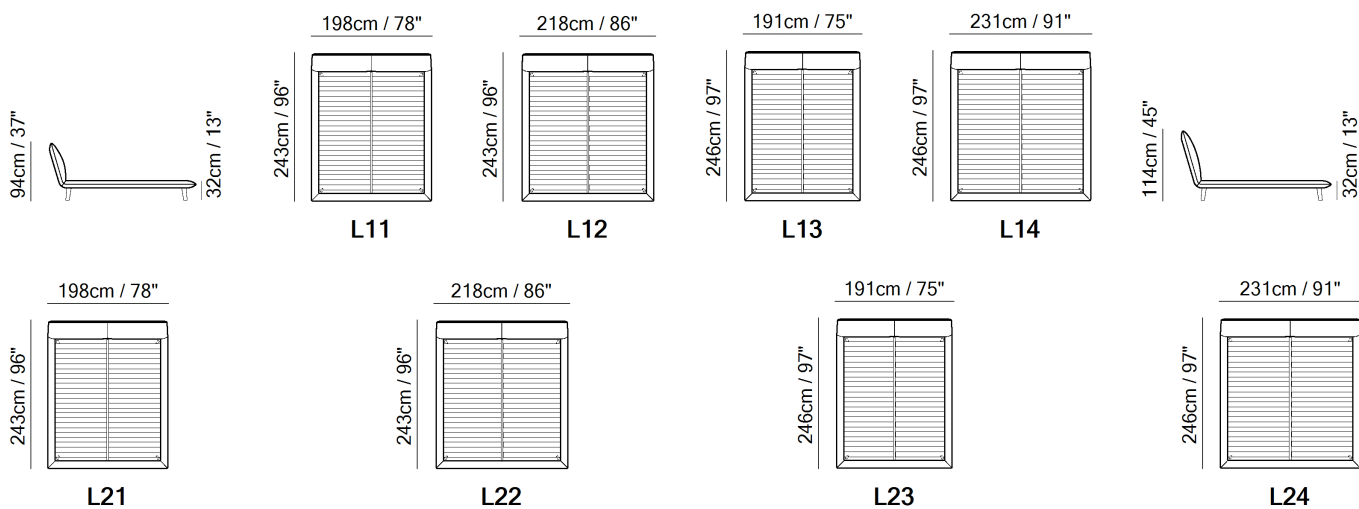

■ Vers. L01

SCHEMATICS



TECHNICAL INFORMATION

| | | | | | | | |
|--|-----------------|--|---|-------------------------------------|---|---|---|
|  | COVERING | Mix <input checked="" type="checkbox"/> | Soft Cover <input checked="" type="checkbox"/> | | | | |
|  | FILLING | Arms | <input type="checkbox"/> Fiber <input type="checkbox"/> Foam <input type="checkbox"/> Feather/Fiber Mix <input type="checkbox"/> Feather | Seat cushion | <input type="checkbox"/> Fiber <input type="checkbox"/> Foam <input type="checkbox"/> Feather/Fiber Mix <input type="checkbox"/> Feather | Back cushion | <input type="checkbox"/> Fiber <input type="checkbox"/> Foam <input type="checkbox"/> Feather/Fiber Mix <input type="checkbox"/> Feather |
|  | COMFORT | Firm Comfort <input type="checkbox"/> | Standard Comfort <input checked="" type="checkbox"/> | | | | |
|  | FUNCTION | Bed <input type="checkbox"/> | Electric motion <input type="checkbox"/> | Motion <input type="checkbox"/> | Recliner <input type="checkbox"/> | Sliding <input type="checkbox"/> | |
|  | LEGS | Wood <input type="checkbox"/> | Metal <input type="checkbox"/> | Plastic <input type="checkbox"/> | Castors <input type="checkbox"/> | Upholstered <input type="checkbox"/> | |

NOTES

- Designed by Claudio Bellini.
- In leather the model is available starting from cat. 15 (Le Mans).
- Bed Piuma L011, all versions when ordered in mix categories, are available in 1B-2B-3A-4A because it has starting price as category 15 in leather and is available with categories 25-30-40.
- FABRIC: Second covering for bed L011 Piuma is always Rizzoli (cat.70) or Laguna (cat.99) both when ordered all in fabric or in mix categories.
- Piuma L011 when ordered in MIX or TWO-TONE fabric, the second covering is always art. Rizzoli, Venus and Laguna.

NOTES



■ Vers. L01



■ Vers. L01





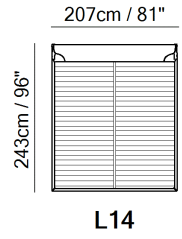
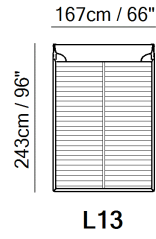
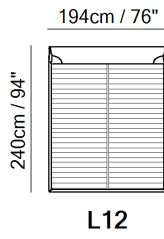
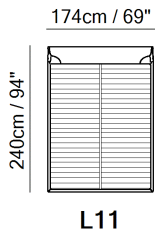
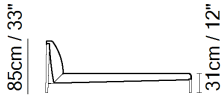

■ Vers. L01

SCHEMATICS



TECHNICAL INFORMATION

| | | | | | | | |
|--|-----------------|--|---|-------------------------------------|---|---|---|
|  | COVERING | Leather <input checked="" type="checkbox"/> | Soft Cover <input checked="" type="checkbox"/> | | | | |
|  | FILLING | Arms | <input type="checkbox"/> Fiber <input type="checkbox"/> Foam <input type="checkbox"/> Feather/Fiber Mix <input type="checkbox"/> Feather | Seat cushion | <input type="checkbox"/> Fiber <input type="checkbox"/> Foam <input type="checkbox"/> Feather/Fiber Mix <input type="checkbox"/> Feather | Back cushion | <input type="checkbox"/> Fiber <input type="checkbox"/> Foam <input type="checkbox"/> Feather/Fiber Mix <input type="checkbox"/> Feather |
|  | COMFORT | Firm Comfort <input type="checkbox"/> | Standard Comfort <input checked="" type="checkbox"/> | | | | |
|  | FUNCTION | Bed <input type="checkbox"/> | Electric motion <input type="checkbox"/> | Motion <input type="checkbox"/> | Recliner <input type="checkbox"/> | Sliding <input type="checkbox"/> | |
|  | LEGS | Metal <input type="checkbox"/> | Wood <input type="checkbox"/> | Castors <input type="checkbox"/> | Plastic <input type="checkbox"/> | Upholstered <input type="checkbox"/> | |

NOTES

- LEATHER: Model is available with articles Le Mans, Status, Stromboli and Siena.
- FABRIC: Bed not available with article Retrò

NOTES



■ Vers. L01



■ Vers. L01





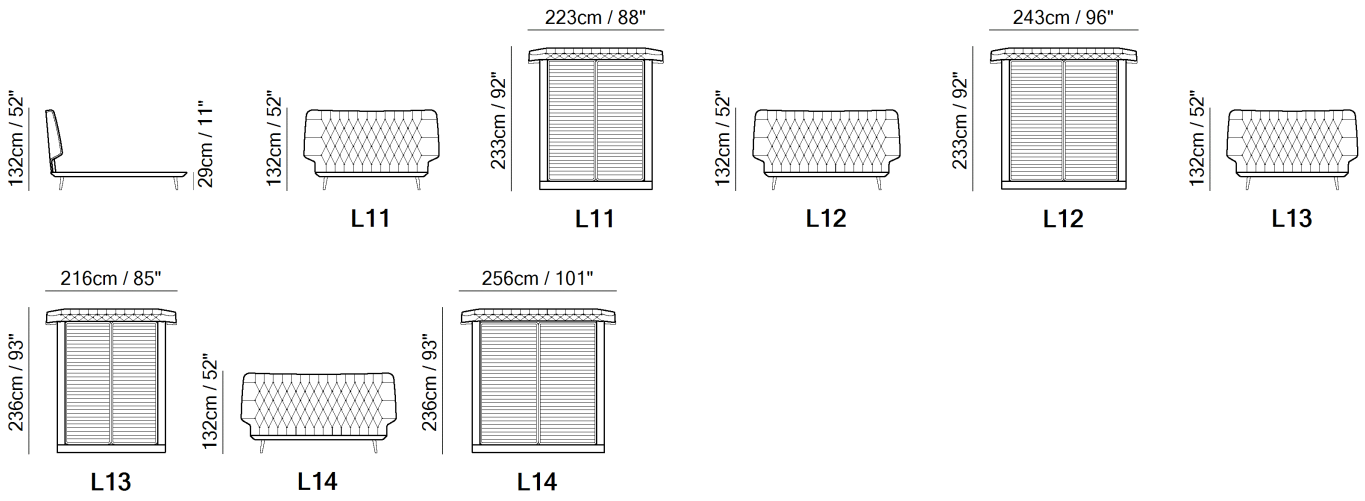

■ Vers. L01

SCHEMATICS



TECHNICAL INFORMATION

| | | | | | | | |
|--|-----------------|--|---|-------------------------------------|---|---|---|
|  | COVERING | Leather <input checked="" type="checkbox"/> | Soft Cover <input checked="" type="checkbox"/> | | | | |
|  | FILLING | Arms | <input type="checkbox"/> Fiber <input type="checkbox"/> Foam <input type="checkbox"/> Feather/Fiber Mix <input type="checkbox"/> Feather | Seat cushion | <input type="checkbox"/> Fiber <input type="checkbox"/> Foam <input type="checkbox"/> Feather/Fiber Mix <input type="checkbox"/> Feather | Back cushion | <input type="checkbox"/> Fiber <input type="checkbox"/> Foam <input type="checkbox"/> Feather/Fiber Mix <input type="checkbox"/> Feather |
|  | COMFORT | Firm Comfort <input type="checkbox"/> | Standard Comfort <input checked="" type="checkbox"/> | | | | |
|  | FUNCTION | Bed <input type="checkbox"/> | Electric motion <input type="checkbox"/> | Motion <input type="checkbox"/> | Recliner <input type="checkbox"/> | Sliding <input type="checkbox"/> | |
|  | LEGS | Wood <input type="checkbox"/> | Metal <input type="checkbox"/> | Plastic <input type="checkbox"/> | Castors <input type="checkbox"/> | Upholstered <input type="checkbox"/> | |

NOTES

- LEATHER: Model is available with articles Le Mans, Status, Stromboli and Siena.
- FABRIC: Bed not available with article Retrò

NOTES



■ Vers. C02



■ Vers. C02





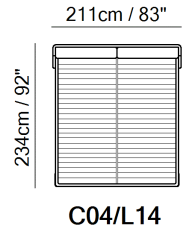
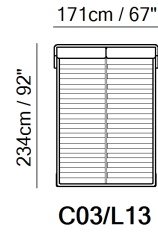
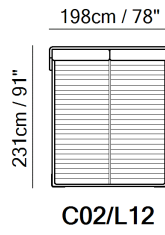
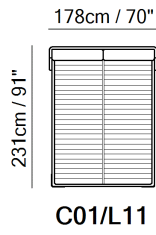
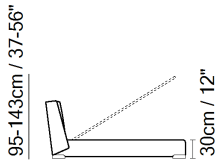

■ Vers. C02

SCHEMATICS



TECHNICAL INFORMATION

| | | | | | | | |
|--|-----------------|--|---|-------------------------------------|---|---|---|
|  | COVERING | Leather <input checked="" type="checkbox"/> | Soft Cover <input checked="" type="checkbox"/> | | | | |
|  | FILLING | Arms | <input type="checkbox"/> Fiber <input type="checkbox"/> Foam <input type="checkbox"/> Feather/Fiber Mix <input type="checkbox"/> Feather | Seat cushion | <input type="checkbox"/> Fiber <input type="checkbox"/> Foam <input type="checkbox"/> Feather/Fiber Mix <input type="checkbox"/> Feather | Back cushion | <input type="checkbox"/> Fiber <input type="checkbox"/> Foam <input type="checkbox"/> Feather/Fiber Mix <input type="checkbox"/> Feather |
|  | COMFORT | Firm Comfort <input type="checkbox"/> | Standard Comfort <input checked="" type="checkbox"/> | | | | |
|  | FUNCTION | Bed <input type="checkbox"/> | Electric motion <input type="checkbox"/> | Motion <input type="checkbox"/> | Recliner <input type="checkbox"/> | Sliding <input type="checkbox"/> | |
|  | LEGS | Metal <input type="checkbox"/> | Wood <input type="checkbox"/> | Castors <input type="checkbox"/> | Plastic <input type="checkbox"/> | Upholstered <input type="checkbox"/> | |

NOTES

- The Fenice bed, created by designers Bernhardt & Vella, stands out thanks to its embracing headboard, with its characteristic large, soft pillows and the geometric detail of the join between the headboard and the frame.
- The gentle tilt of the headboard offers a comfortable reading position.
- The metal feet inserted into the structure enhance its design.
- LEATHER: Model is available with articles Le Mans, Status, Stromboli and Siena.
- FABRIC: Bed not available with article Retrò
- Bed available with optional storage compartment (vers. C0_)
- The C01, C02, and C03 versions require a mattress with a minimum weight of 34 kg and a maximum weight of 39 kg. The C04 version requires a mattress with a minimum weight of 40 kg and a maximum weight of 45 kg.

NOTES



■ Vers. L12



■ Vers. L12





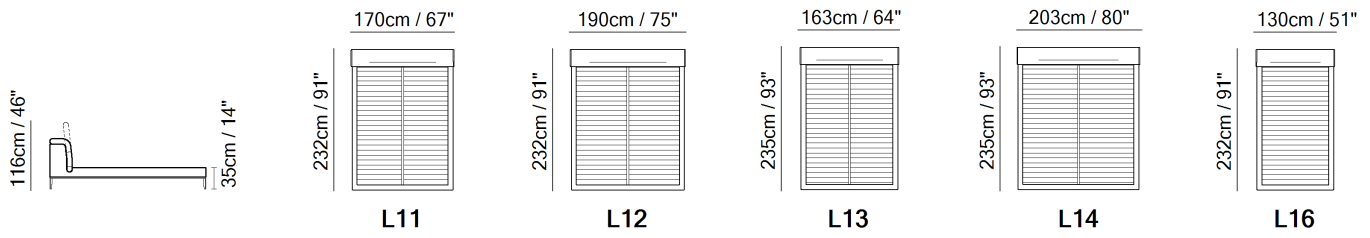

■ Vers. L16

SCHEMATICS



TECHNICAL INFORMATION

| | | | | | | | |
|--|-----------------|--|---|-------------------------------------|---|---|---|
|  | COVERING | Mix <input checked="" type="checkbox"/> | Leather <input checked="" type="checkbox"/> | | | | |
|  | FILLING | Arms | <input type="checkbox"/> Fiber <input type="checkbox"/> Foam <input type="checkbox"/> Feather/Fiber Mix <input type="checkbox"/> Feather | Seat cushion | <input type="checkbox"/> Fiber <input type="checkbox"/> Foam <input type="checkbox"/> Feather/Fiber Mix <input type="checkbox"/> Feather | Back cushion | <input type="checkbox"/> Fiber <input type="checkbox"/> Foam <input type="checkbox"/> Feather/Fiber Mix <input type="checkbox"/> Feather |
|  | COMFORT | Firm Comfort <input type="checkbox"/> | Standard Comfort <input checked="" type="checkbox"/> | | | | |
|  | FUNCTION | Bed <input type="checkbox"/> | Electric motion <input type="checkbox"/> | Motion <input type="checkbox"/> | Recliner <input type="checkbox"/> | Sliding <input type="checkbox"/> | |
|  | LEGS | Wood <input type="checkbox"/> | Metal <input type="checkbox"/> | Plastic <input type="checkbox"/> | Castors <input type="checkbox"/> | Upholstered <input type="checkbox"/> | |

NOTES

- In leather the model is available starting from cat. 15 (Le Mans).
- Leather/Fabric MIX CATEGORIES are based on the STARTING PRICE CATEGORY OF LEATHER combined with fabric = cat. 1A (cat.10 + fabric) - 1B (cat.15 + fabric) - 2A (cat. 20 ...) - 2B (cat. 25 ...) - 3A (cat. 30 ...) - 3B (cat. 35 ...) - 4A (cat. 40 ...) - 5E (cat. 55 ...)

NOTES



■ Vers. C12



■ Vers. C12





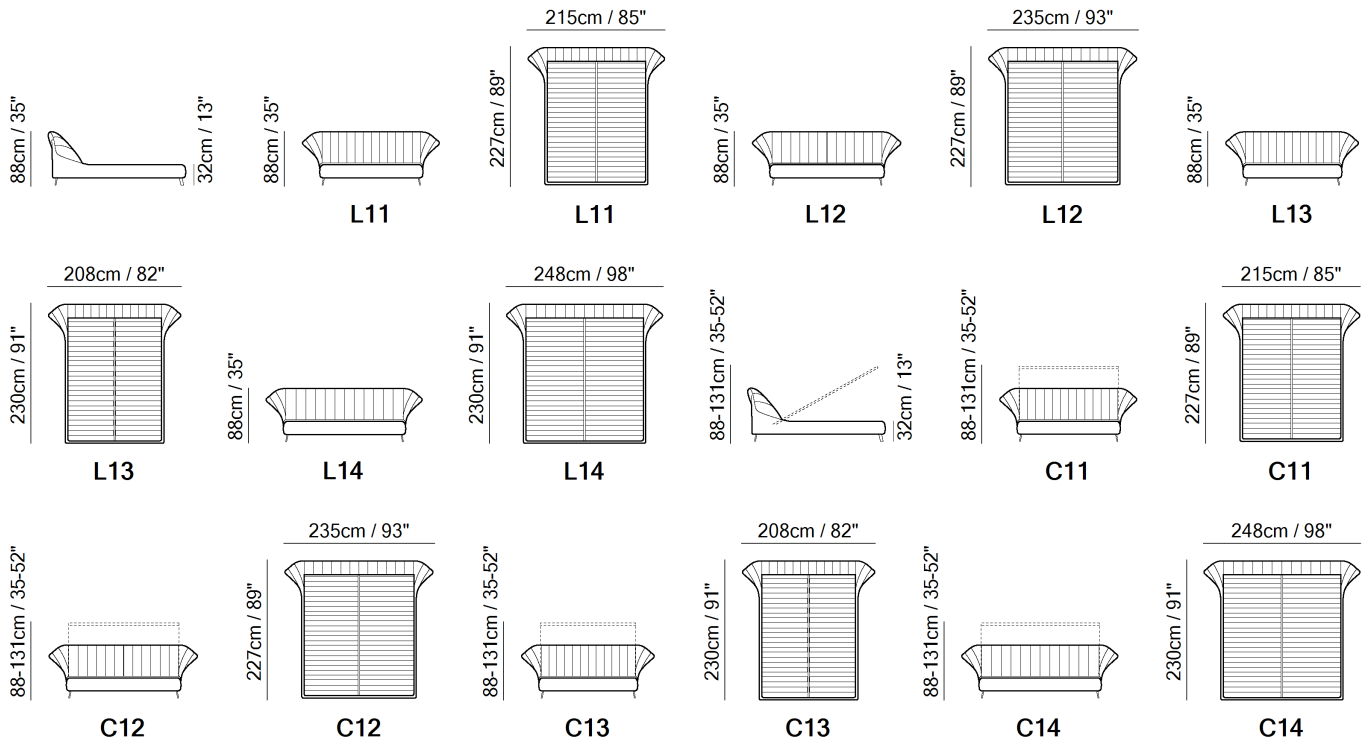

■ Vers. C12

SCHEMATICS



TECHNICAL INFORMATION

| | | | | | | | |
|--|-----------------|--|---|-------------------------------------|---|---|---|
|  | COVERING | Leather <input checked="" type="checkbox"/> | Soft Cover <input checked="" type="checkbox"/> | | | | |
|  | FILLING | Arms | <input type="checkbox"/> Fiber <input type="checkbox"/> Foam <input type="checkbox"/> Feather/Fiber Mix <input type="checkbox"/> Feather | Seat cushion | <input type="checkbox"/> Fiber <input type="checkbox"/> Foam <input type="checkbox"/> Feather/Fiber Mix <input type="checkbox"/> Feather | Back cushion | <input type="checkbox"/> Fiber <input type="checkbox"/> Foam <input type="checkbox"/> Feather/Fiber Mix <input type="checkbox"/> Feather |
|  | COMFORT | Firm Comfort <input type="checkbox"/> | Standard Comfort <input checked="" type="checkbox"/> | | | | |
|  | FUNCTION | Bed <input type="checkbox"/> | Electric motion <input type="checkbox"/> | Motion <input type="checkbox"/> | Recliner <input type="checkbox"/> | Sliding <input type="checkbox"/> | |
|  | LEGS | Metal <input checked="" type="checkbox"/> | Wood <input type="checkbox"/> | Castors <input type="checkbox"/> | Plastic <input type="checkbox"/> | Upholstered <input type="checkbox"/> | |

NOTES

- The minimal, the essential design of the bed matched with the perfect balance in the softly padded headboard and the simple, well-defined stitching gives CALA a dynamic style
- A versatile bed for its dimensions and upholstery: available in 4 sizes to satisfy all needs of space and in a wide range of leathers and Natuzzi Italia fabrics, also in combinations for all tastes.
- OPTIONAL SECRET BOX. The C11-C12-C13-C14 versions have a convenient secret box under the frame with a sliding drawer that allows you to store items or bed linen
- The C11, C12, and C13 versions require a mattress with a minimum weight of 34 kg and a maximum weight of 39 kg. The C14 version requires a mattress with a minimum weight of 40 kg and a maximum weight of 45 kg.
- The bed is completed with a bench (version 539) available in the same coverings enabled for the bed.
- Internal wooden frame.
- Feet will be in a bag inside the package and requires assembling.
- Front metal feet are positioned differently from rear giving the bed a unique elegant visual impact.
- Feet available in metal finishing 78 (Black Chrome)

NOTES



■ Vers. C02



■ Vers. C02





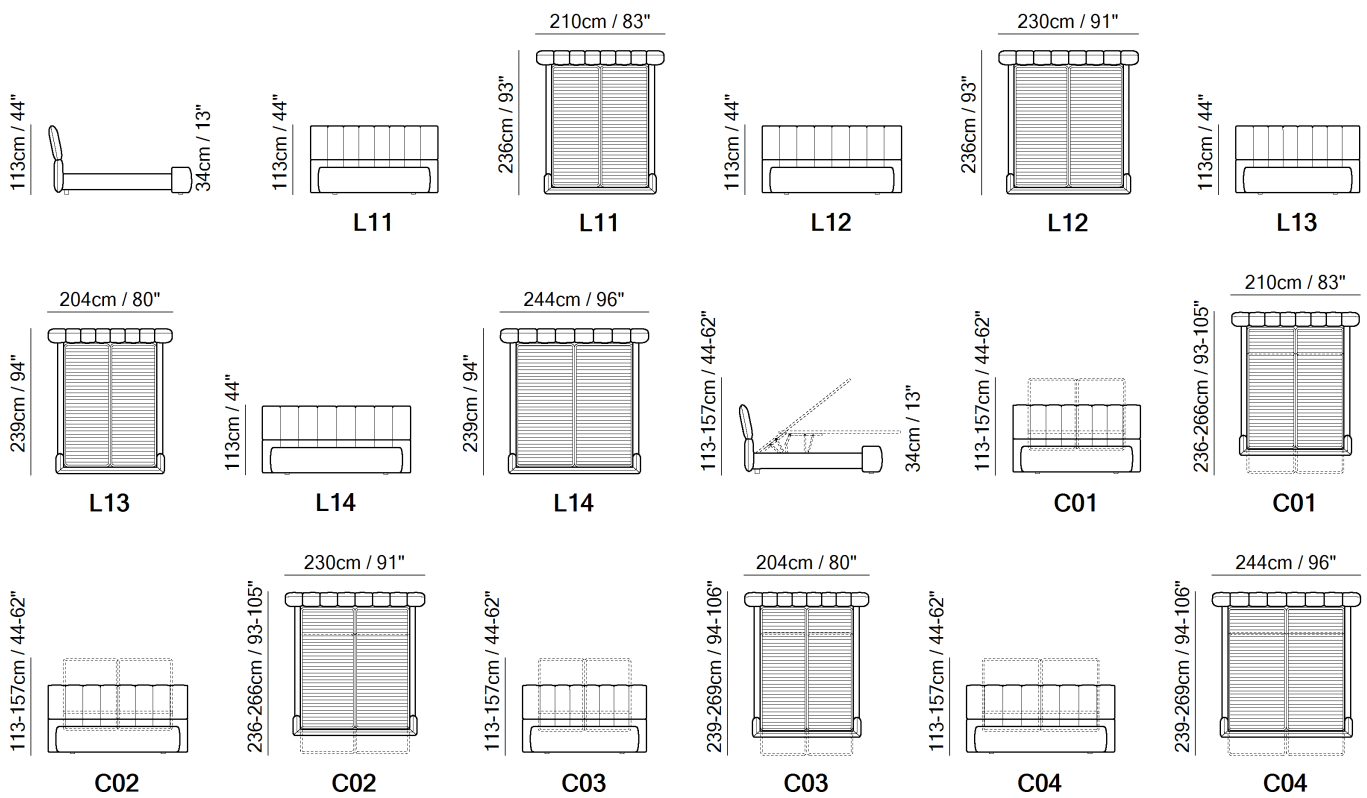

■ Vers. C02

SCHEMATICS



TECHNICAL INFORMATION

| | | | | | | | |
|--|-----------------|--|---|-------------------------------------|---|---|---|
|  | COVERING | Leather <input checked="" type="checkbox"/> | Soft Cover <input checked="" type="checkbox"/> | | | | |
|  | FILLING | Arms | <input type="checkbox"/> Fiber <input type="checkbox"/> Foam <input type="checkbox"/> Feather/Fiber Mix <input type="checkbox"/> Feather | Seat cushion | <input type="checkbox"/> Fiber <input type="checkbox"/> Foam <input type="checkbox"/> Feather/Fiber Mix <input type="checkbox"/> Feather | Back cushion | <input type="checkbox"/> Fiber <input type="checkbox"/> Foam <input type="checkbox"/> Feather/Fiber Mix <input type="checkbox"/> Feather |
|  | COMFORT | Firm Comfort <input type="checkbox"/> | Standard Comfort <input checked="" type="checkbox"/> | | | | |
|  | FUNCTION | Bed <input type="checkbox"/> | Electric motion <input type="checkbox"/> | Motion <input type="checkbox"/> | Recliner <input type="checkbox"/> | Sliding <input type="checkbox"/> | |
|  | LEGS | Wood <input type="checkbox"/> | Metal <input type="checkbox"/> | Plastic <input type="checkbox"/> | Castors <input type="checkbox"/> | Upholstered <input type="checkbox"/> | |

NOTES

- Bed available with optional storage compartment (vers. C0_)
- The C01, C02, and C03 versions require a mattress with a minimum weight of 34 kg and a maximum weight of 39 kg. The C04 version requires a mattress with a minimum weight of 40 kg and a maximum weight of 45 kg.

NOTES



■ Vers. L12



■ Vers. L12







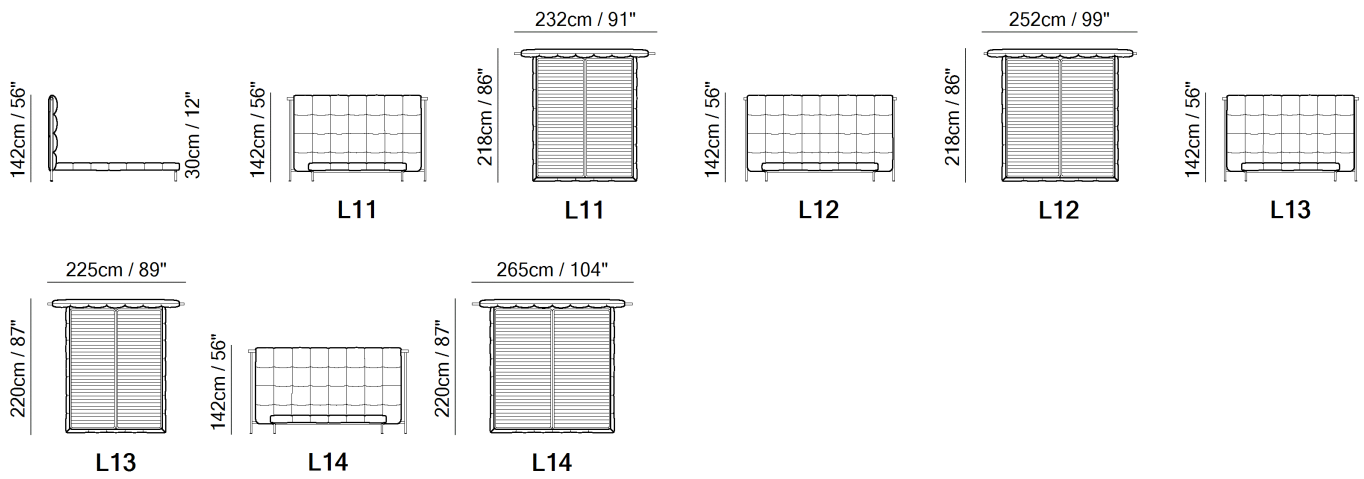

■ Vers. L12

SCHEMATICS



TECHNICAL INFORMATION

| | | | | | | | |
|--|---------------------------|---|---|--|---|--------------------------------------|---|
|  | COVERING | Leather <input checked="" type="checkbox"/> | Soft Cover <input checked="" type="checkbox"/> | | | | |
|  | FILLING | Arms | <input type="checkbox"/> Fiber <input type="checkbox"/> Foam <input type="checkbox"/> Feather/Fiber Mix <input type="checkbox"/> Feather | Seat cushion | <input type="checkbox"/> Fiber <input type="checkbox"/> Foam <input type="checkbox"/> Feather/Fiber Mix <input type="checkbox"/> Feather | Back cushion | <input type="checkbox"/> Fiber <input type="checkbox"/> Foam <input type="checkbox"/> Feather/Fiber Mix <input type="checkbox"/> Feather |
|  | COMFORT | Firm Comfort <input type="checkbox"/> | Standard Comfort <input checked="" type="checkbox"/> | | | | |
|  | FUNCTION | Bed <input type="checkbox"/> | Electric motion <input type="checkbox"/> | Motion <input type="checkbox"/> | Recliner <input type="checkbox"/> | Sliding <input type="checkbox"/> | |
|  | VISUAL APPEARANCE* | Low <input type="checkbox"/> | Medium <input type="checkbox"/> | High <input checked="" type="checkbox"/> | | | |
|  | LEGS | Metal <input type="checkbox"/> | Wood <input type="checkbox"/> | Castors <input type="checkbox"/> | Plastic <input type="checkbox"/> | Upholstered <input type="checkbox"/> | |

VISUAL APPEARANCE

The product may reveal various wrinkles due to the combination of Elasticity of the covering, characteristics of the interior construction and the design of the product.



Products with Visual Appearance listed as High or Medium would require higher degree of care, where seats and back cushions may require fluffing and plumping more often than Products with Visual Appearance listed as Low.

NOTES

- In leather the model is available starting from cat. 15 (Le Mans).
- Model is not available with article Misterbianco (cat. 30).
- The headboard is also covered on the back to allow the positioning of the bed even in the middle of the room.
- Powder coated cocoa finish

NOTES



■ Vers. L12



■ Vers. L12







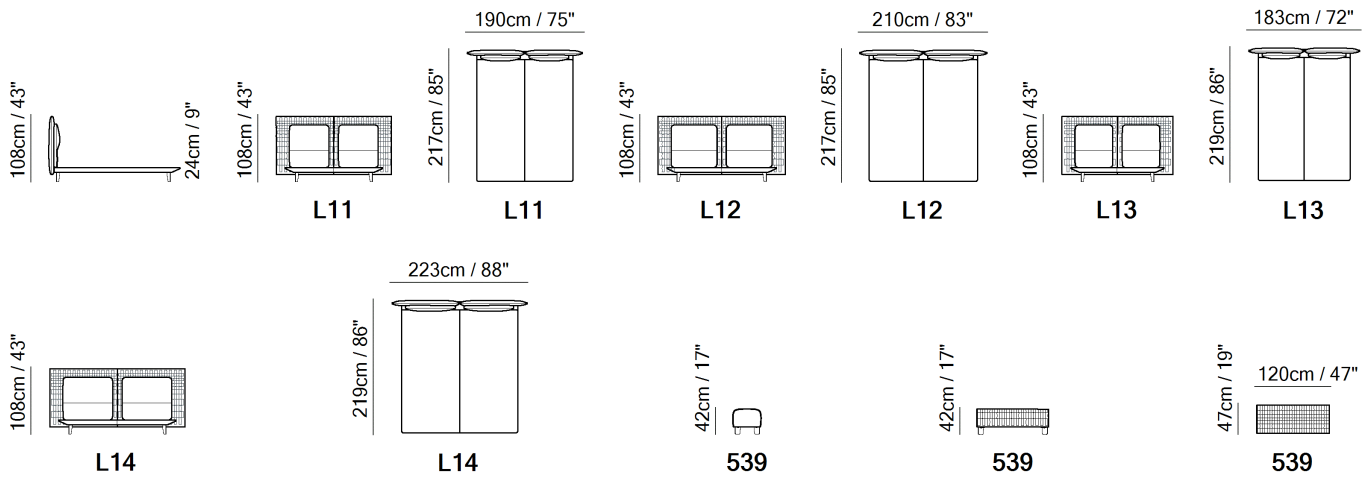

■ Vers. L12+539

SCHEMATICS



TECHNICAL INFORMATION

| | | | | | | | |
|--|---------------------------|--|---|-------------------------------------|---|---|---|
|  | COVERING | Leather <input checked="" type="checkbox"/> | Soft Cover <input checked="" type="checkbox"/> | | | | |
|  | FILLING | Arms | <input type="checkbox"/> Fiber <input type="checkbox"/> Foam <input type="checkbox"/> Feather/Fiber Mix <input type="checkbox"/> Feather | Seat cushion | <input type="checkbox"/> Fiber <input type="checkbox"/> Foam <input type="checkbox"/> Feather/Fiber Mix <input type="checkbox"/> Feather | Back cushion | <input type="checkbox"/> Fiber <input type="checkbox"/> Foam <input type="checkbox"/> Feather/Fiber Mix <input type="checkbox"/> Feather |
|  | COMFORT | Firm Comfort <input type="checkbox"/> | Standard Comfort <input checked="" type="checkbox"/> | | | | |
|  | FUNCTION | Bed <input type="checkbox"/> | Electric motion <input type="checkbox"/> | Motion <input type="checkbox"/> | Recliner <input type="checkbox"/> | Sliding <input type="checkbox"/> | |
|  | VISUAL APPEARANCE* | Low <input type="checkbox"/> | Medium <input checked="" type="checkbox"/> | High <input type="checkbox"/> | | | |
|  | LEGS | Wood <input type="checkbox"/> | Metal <input type="checkbox"/> | Plastic <input type="checkbox"/> | Castors <input type="checkbox"/> | Upholstered <input type="checkbox"/> | |

VISUAL APPEARANCE

The product may reveal various wrinkles due to the combination of Elasticity of the covering, characteristics of the interior construction and the design of the product.



Products with Visual Appearance listed as High or Medium would require higher degree of care, where seats and back cushions may require fluffing and plumping more often than Products with Visual Appearance listed as Low.

NOTES

- Designed by Mauro Lipparini.
- In leather the model is available starting from cat. 15 (Le Mans).
- The headboard is also covered on the back to allow the positioning of the bed even in the middle of the room.
- L025 available with Gargano woven leather to order as second cover. The first cover is associated with cushions that can be upholstered in leather or fabric. These cushions are removable
- LR25 without weave and available in leather or fabric (single cover)
- Available in 4 sizes: 160x200-180x200-153x200-193X200 cm. More sizes to meet every need of space and possibility to cover the bed with the wide range of Natuzzi Italia coverings.
- Powder coated feet available in the same finishes of the sofa or ft 46 champagne or ft 79 matt black

NOTES



■ Vers. L11







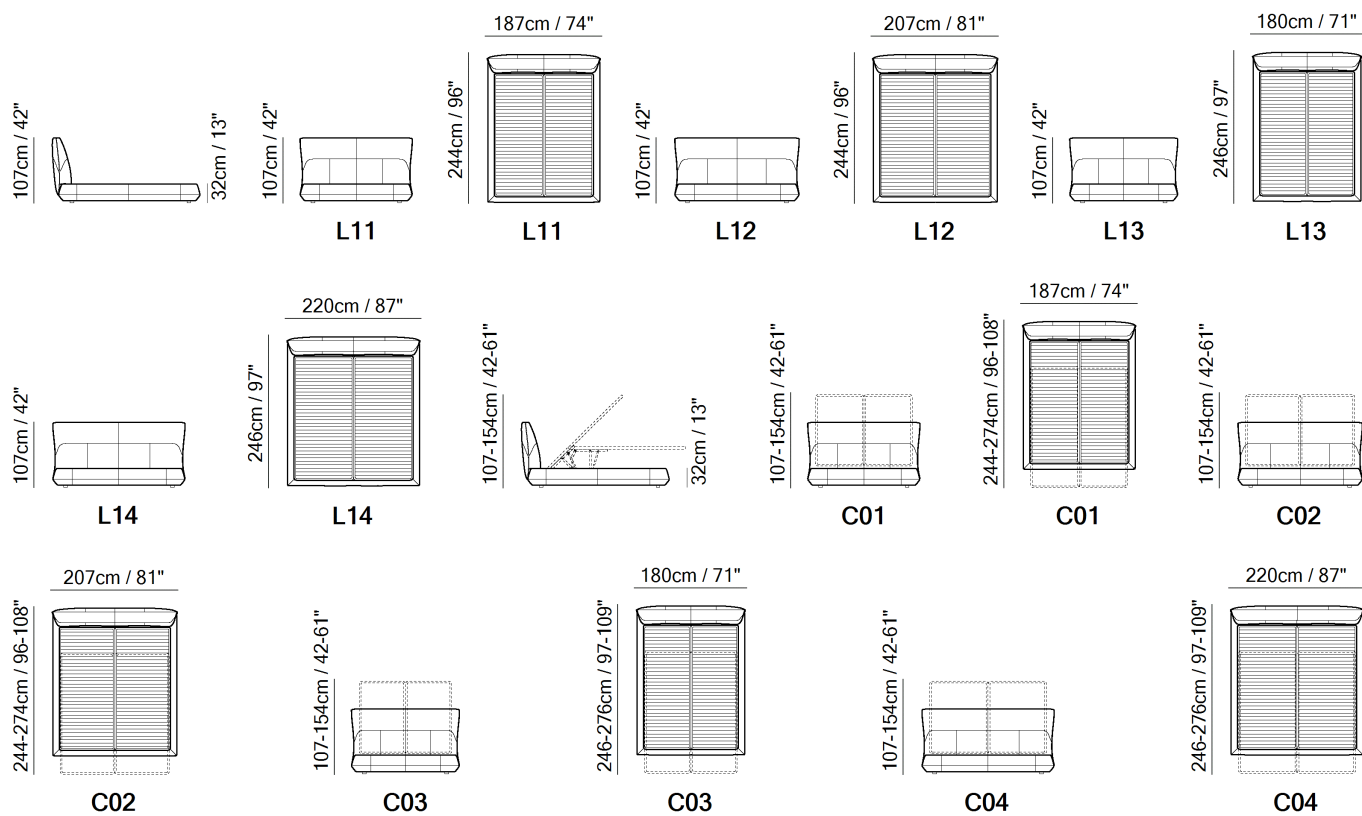

■ Vers. L11

SCHEMATICS



TECHNICAL INFORMATION

| | | | | | | | |
|--|---------------------------|--|---|--|---|--------------------------------------|---|
|  | COVERING | Leather <input checked="" type="checkbox"/> | Soft Cover <input checked="" type="checkbox"/> | | | | |
|  | FILLING | Arms | <input type="checkbox"/> Fiber <input type="checkbox"/> Foam <input type="checkbox"/> Feather/Fiber Mix <input type="checkbox"/> Feather | Seat cushion | <input type="checkbox"/> Fiber <input type="checkbox"/> Foam <input type="checkbox"/> Feather/Fiber Mix <input type="checkbox"/> Feather | Back cushion | <input type="checkbox"/> Fiber <input type="checkbox"/> Foam <input type="checkbox"/> Feather/Fiber Mix <input type="checkbox"/> Feather |
|  | COMFORT | Standard Comfort <input checked="" type="checkbox"/> | Firm Comfort <input type="checkbox"/> | | | | |
|  | FUNCTION | Bed <input type="checkbox"/> | Electric motion <input type="checkbox"/> | Motion <input type="checkbox"/> | Recliner <input type="checkbox"/> | Sliding <input type="checkbox"/> | |
|  | VISUAL APPEARANCE* | Low <input type="checkbox"/> | Medium <input type="checkbox"/> | High <input checked="" type="checkbox"/> | | | |
|  | LEGS | Metal <input type="checkbox"/> | Wood <input type="checkbox"/> | Castors <input type="checkbox"/> | Plastic <input type="checkbox"/> | Upholstered <input type="checkbox"/> | |

VISUAL APPEARANCE

The product may reveal various wrinkles due to the combination of Elasticity of the covering, characteristics of the interior construction and the design of the product.



Products with Visual Appearance listed as High or Medium would require higher degree of care, where seats and back cushions may require fluffing and plumping more often than Products with Visual Appearance listed as Low.

NOTES

- Designed by Natuzzi Design Center.
- In leather the model is available starting from cat. 15 (Le Mans).
- The headboard is also covered on the back to allow the positioning of the bed even in the middle of the room.
- Available in 4 sizes: 160x200-180x200-153x200-193X200 cm. More sizes to meet every need of space and possibility to cover the bed with the wide range of Natuzzi Italia coverings.
- Anti-scratch and non-slip hidden feet.
- Bed available with optional storage compartment (vers. C0_)
- The C01, C02, and C03 versions require a mattress with a minimum weight of 34 kg and a maximum weight of 39 kg. The C04 version requires a mattress with a minimum weight of 40 kg and a maximum weight of 45 kg.

NOTES



■ Vers. L11



■ Vers. L11







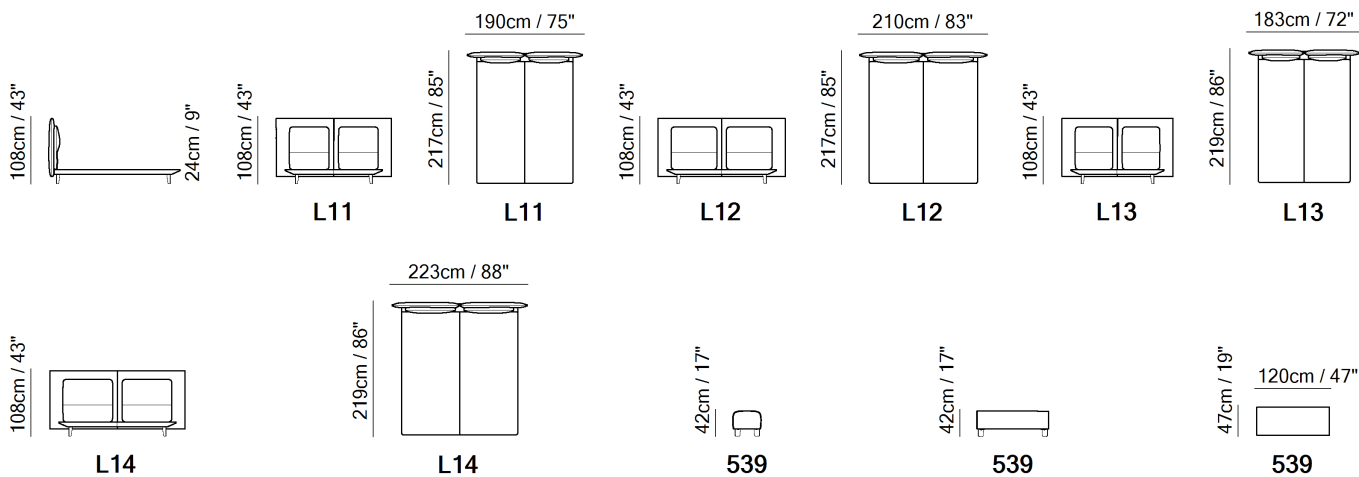

■ Vers. L11

SCHEMATICS



TECHNICAL INFORMATION

| | | | | | | | |
|--|---------------------------|--|---|----------------------------------|---|--------------------------------------|---|
|  | COVERING | Leather <input checked="" type="checkbox"/> | Soft Cover <input checked="" type="checkbox"/> | | | | |
|  | FILLING | Arms | <input type="checkbox"/> Fiber <input type="checkbox"/> Foam <input type="checkbox"/> Feather/Fiber Mix <input type="checkbox"/> Feather | Seat cushion | <input type="checkbox"/> Fiber <input type="checkbox"/> Foam <input type="checkbox"/> Feather/Fiber Mix <input type="checkbox"/> Feather | Back cushion | <input type="checkbox"/> Fiber <input type="checkbox"/> Foam <input type="checkbox"/> Feather/Fiber Mix <input type="checkbox"/> Feather |
|  | COMFORT | Standard Comfort <input checked="" type="checkbox"/> | Firm Comfort <input type="checkbox"/> | | | | |
|  | FUNCTION | Bed <input type="checkbox"/> | Electric motion <input type="checkbox"/> | Motion <input type="checkbox"/> | Recliner <input type="checkbox"/> | Sliding <input type="checkbox"/> | |
|  | VISUAL APPEARANCE* | Low <input type="checkbox"/> | Medium <input checked="" type="checkbox"/> | High <input type="checkbox"/> | | | |
|  | LEGS | Wood <input type="checkbox"/> | Metal <input type="checkbox"/> | Plastic <input type="checkbox"/> | Castors <input type="checkbox"/> | Upholstered <input type="checkbox"/> | |

VISUAL APPEARANCE

The product may reveal various wrinkles due to the combination of Elasticity of the covering, characteristics of the interior construction and the design of the product.



Products with Visual Appearance listed as High or Medium would require higher degree of care, where seats and back cushions may require fluffing and plumping more often than Products with Visual Appearance listed as Low.

NOTES

- Designed by Mauro Lipparini.
- LR25 without weave and available in leather or fabric (single cover)
- L025 available with Gargano woven leather to order as second cover. The first cover is associated with cushions that can be upholstered in leather or fabric. These cushions are removable
- In leather the model is available starting from cat. 15 (Le Mans).
- The headboard is also covered on the back to allow the positioning of the bed even in the middle of the room.
- Available in 4 sizes: 160x200-180x200-153x200-193X200 cm. More sizes to meet every need of space and possibility to cover the bed with the wide range of Natuzzi Italia coverings.
- Powder coated feet available in the same finishes of the sofa or ft 46 champagne or ft 79 matt black

NOTES
