



■ Vers. 376























■ Vers. 112+119







■ Vers. 124+245

## SCHEMATICS

<p>50cm / 20"    <b>122/222</b>  <b>238</b></p>	<p>50cm / 20"    <b>122/222</b>  <b>238</b></p>	<p>14cm / 6"            50cm / 20"    <b>122/222</b>  <b>238</b></p>	<p>53cm / 21"    <b>376</b></p>	<p>53cm / 21"    <b>376</b></p>	<p>14cm / 6"            53cm / 21"    <b>376</b></p>	<p>38cm / 15"    <b>385</b></p>	<p>38cm / 15"    <b>385</b></p>	<p>14cm / 6"            60cm / 24"    <b>385</b></p>	<p>26cm / 10"    <b>112</b></p>	<p>26cm / 10"    <b>112</b></p>
<p>14cm / 6"            62cm / 24"    <b>112</b></p>	<p>35cm / 14"    <b>245</b></p>	<p>35cm / 14"    <b>245</b></p>	<p>14cm / 6"            50cm / 20"    <b>245</b></p>	<p>45cm / 18"    <b>119</b></p>	<p>45cm / 18"    <b>119</b></p>	<p>14cm / 6"            45cm / 18"    <b>119</b></p>	<p>20cm / 8"    <b>124</b></p>	<p>20cm / 8"    <b>124</b></p>	<p>20cm / 8"            60cm / 24"    <b>124</b></p>	

## TECHNICAL INFORMATION

	<b>COVERING</b>	Leather <input checked="" type="checkbox"/>	Soft Cover <input checked="" type="checkbox"/>				
	<b>FILLING</b>	Arms	<input type="checkbox"/> Fiber <input type="checkbox"/> Foam <input type="checkbox"/> Feather/Fiber Mix <input type="checkbox"/> Feather	Seat cushion	<input checked="" type="checkbox"/> Fiber <input type="checkbox"/> Foam <input type="checkbox"/> Feather/Fiber Mix <input checked="" type="checkbox"/> Feather	Back cushion	<input type="checkbox"/> Fiber <input type="checkbox"/> Foam <input type="checkbox"/> Feather/Fiber Mix <input type="checkbox"/> Feather
	<b>COMFORT</b>	Firm Comfort <input type="checkbox"/>	Standard Comfort <input checked="" type="checkbox"/>				
	<b>FUNCTION</b>	Bed <input type="checkbox"/>	Electric motion <input type="checkbox"/>	Motion <input type="checkbox"/>	Recliner <input type="checkbox"/>	Sliding <input type="checkbox"/>	
	<b>LEGS</b>	Wood <input type="checkbox"/>	Metal <input type="checkbox"/>	Plastic <input type="checkbox"/>	Castors <input type="checkbox"/>	Upholstered <input type="checkbox"/>	

## NOTES

- Designed by Natuzzi Design Center.
- Behind the pillow is perforated for all versions in leather.
- Version 122 has fibre filling and no welt.
- Version 222 has feather filling and welt.
- Version 238 has feather filling and no welt.
- Version 376 (squared) has feathers filling and stitching.
- Version 385 (rectangular) has feathers filling and stitching.
- Version 112 (lumbar support pillow) has feathers filling.
- Version 245 (rectangular with band) has fibre filling.
- Version 119 (squared with band) has fibre filling.
- Version 124 (roll) has fibre filling.
- TWO TONE COVERING OPTIONS:
- 1° COV. = Cushion (only version 222)
- 2° COV. = Welt

NOTES

---



■ Vers. 010



■ Vers. 010





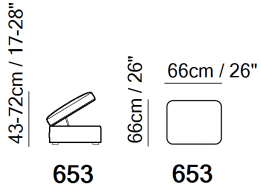
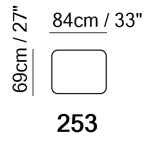
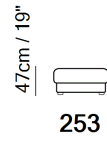
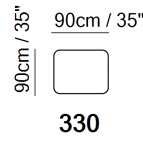
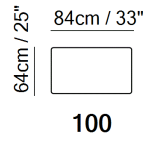
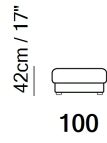
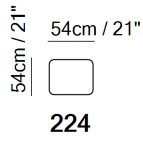
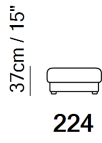
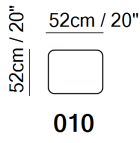
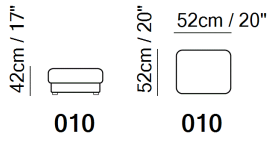

■ Vers. 100

**SCHEMATICS**



## TECHNICAL INFORMATION

	<b>COVERING</b>	Leather <input checked="" type="checkbox"/>	Soft Cover <input checked="" type="checkbox"/>			
	<b>FILLING</b>	Arms <input type="checkbox"/> Fiber <input checked="" type="checkbox"/> Foam <input type="checkbox"/> Feather/Fiber Mix <input type="checkbox"/> Feather	Seat cushion <input type="checkbox"/> Fiber <input checked="" type="checkbox"/> Foam <input type="checkbox"/> Feather/Fiber Mix <input type="checkbox"/> Feather	Back cushion <input type="checkbox"/> Fiber <input checked="" type="checkbox"/> Foam <input type="checkbox"/> Feather/Fiber Mix <input type="checkbox"/> Feather		
	<b>COMFORT</b>	Standard Comfort <input checked="" type="checkbox"/>	Firm Comfort <input type="checkbox"/>			
	<b>FUNCTION</b>	Bed <input type="checkbox"/>	Electric motion <input type="checkbox"/>	Motion <input type="checkbox"/>	Recliner <input type="checkbox"/>	Sliding <input type="checkbox"/>
	<b>LEGS</b>	Wood <input type="checkbox"/>	Plastic <input checked="" type="checkbox"/>	Metal <input type="checkbox"/>	Upholstered <input type="checkbox"/>	Castors <input type="checkbox"/>

## NOTES

- Model available with accents fabric.
- LEATHER: Model available only in Top Grain leather
- Tight Seat Cushion (the seat cushions of the models are fixed to the frame)
- Internal wooden frame.
- Feet will be in a bag inside the package and requires assembling.
- Feet height 3,0 cm

NOTES

---



■ Vers. 256+256+256+256



■ Vers. 256+256





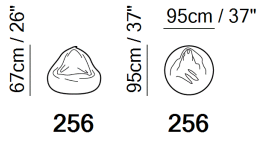

■ Vers. 256+256

## SCHEMATICS

---



## TECHNICAL INFORMATION

	<b>COVERING</b>	Soft Cover <input checked="" type="checkbox"/>					
	<b>FILLING</b>	Arms	<input type="checkbox"/> Fiber <input type="checkbox"/> Foam <input type="checkbox"/> Feather/Fiber Mix <input type="checkbox"/> Feather	Seat cushion	<input type="checkbox"/> Fiber <input type="checkbox"/> Foam <input type="checkbox"/> Feather/Fiber Mix <input type="checkbox"/> Feather	Back cushion	<input type="checkbox"/> Fiber <input type="checkbox"/> Foam <input type="checkbox"/> Feather/Fiber Mix <input type="checkbox"/> Feather
	<b>COMFORT</b>	Standard Comfort <input checked="" type="checkbox"/>	Firm Comfort <input type="checkbox"/>				
	<b>FUNCTION</b>	Bed <input type="checkbox"/>	Electric motion <input type="checkbox"/>	Motion <input type="checkbox"/>	Recliner <input type="checkbox"/>	Sliding <input type="checkbox"/>	
	<b>LEGS</b>	Wood <input type="checkbox"/>	Metal <input type="checkbox"/>	Plastic <input type="checkbox"/>	Castors <input type="checkbox"/>	Upholstered <input type="checkbox"/>	

## NOTES

- Designed by Natuzzi Design Center.
- Available in leather or fabric.
- In leather the model is available starting from cat. 15 (Le Mans).
- Model not available in Misterbianco and Cassidy leathers.
- Available only in fabric, Byborre included. Second cover (Natuzzi Italia logo bands) is always in leather from the color palette of the Le Mans article
- Polystyrene padding that makes it lightweight and easily transportable everywhere

NOTES

---



■ Vers. 009



■ Vers. 016+011+001+002+113



■ Vers. 000+029+017



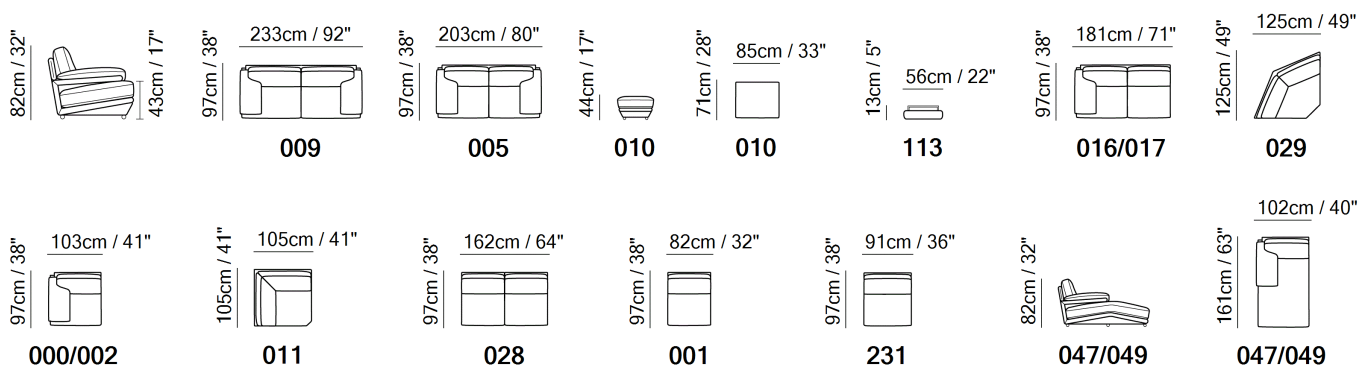

## SCHEMATICS

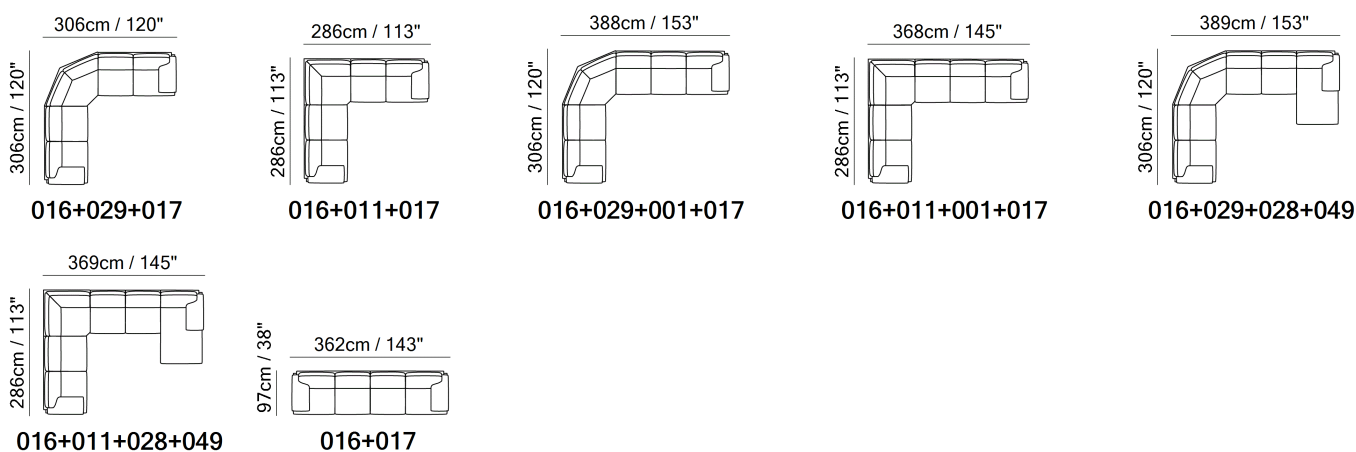

## COMPOSITION EXAMPLES



TECHNICAL INFORMATION

	<b>COVERING</b>	Leather <input checked="" type="checkbox"/>	Soft Cover <input checked="" type="checkbox"/>				
	<b>FILLING</b>	Arms	<input type="checkbox"/> Fiber <input checked="" type="checkbox"/> Foam <input type="checkbox"/> Feather/Fiber Mix <input type="checkbox"/> Feather	Seat cushion	<input type="checkbox"/> Fiber <input checked="" type="checkbox"/> Foam <input type="checkbox"/> Feather/Fiber Mix <input type="checkbox"/> Feather	Back cushion	<input type="checkbox"/> Fiber <input checked="" type="checkbox"/> Foam <input type="checkbox"/> Feather/Fiber Mix <input type="checkbox"/> Feather
	<b>COMFORT</b>	Standard Comfort <input checked="" type="checkbox"/>	Firm Comfort <input checked="" type="checkbox"/>				
	<b>FUNCTION</b>	Bed <input type="checkbox"/>	Electric motion <input type="checkbox"/>	Motion <input type="checkbox"/>	Recliner <input type="checkbox"/>	Sliding <input type="checkbox"/>	
	<b>LEGS</b>	Wood <input checked="" type="checkbox"/>	Plastic <input type="checkbox"/>	Metal <input checked="" type="checkbox"/>	Upholstered <input type="checkbox"/>	Castors <input type="checkbox"/>	

NOTES

- Plaza, a Natuzzi original design, is enjoyed by countless happy customers worldwide.
- The armrest has a well-articulated eye-catching cushion design, which when viewed side-on, envelopes the seat cushion and outlines the entire profile.
- Plaza fits well in a myriad of interiors, making it one of our most sought after designs.
- Tight Seat Cushion (the seat cushions of the models are fixed to the frame)
- Tight Back Cushion (the back cushions of the models are fixed to the frame)
- No Leather/Fabric Side (the sectional pieces have the side covered with lining and not leather nor fabric)
- Internal wooden frame.
- Feet will be in a bag inside the package and requires assembling.
- Feet available in wood finishings 09 (Walnut) / 18 (Wengè)
- Feet available in metal finishing 75 (Glazed Nickel)
- Feet height 6,5 cm

NOTES

---



■ Vers. 244



■ Vers. 244





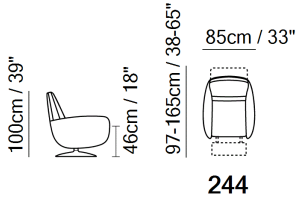

■ Vers. 244

SCHEMATICS

---



TECHNICAL INFORMATION

	<b>COVERING</b>	Leather <input checked="" type="checkbox"/>	Soft Cover <input checked="" type="checkbox"/>				
	<b>FILLING</b>	Arms	<input type="checkbox"/> Fiber <input checked="" type="checkbox"/> Foam <input type="checkbox"/> Feather/Fiber Mix <input type="checkbox"/> Feather	Seat cushion	<input type="checkbox"/> Fiber <input checked="" type="checkbox"/> Foam <input type="checkbox"/> Feather/Fiber Mix <input type="checkbox"/> Feather	Back cushion	<input type="checkbox"/> Fiber <input checked="" type="checkbox"/> Foam <input type="checkbox"/> Feather/Fiber Mix <input type="checkbox"/> Feather
	<b>COMFORT</b>	Standard Comfort <input checked="" type="checkbox"/>	Firm Comfort <input checked="" type="checkbox"/>				
	<b>FUNCTION</b>	Bed <input type="checkbox"/>	Electric motion <input type="checkbox"/>	Motion <input type="checkbox"/>	Recliner <input checked="" type="checkbox"/>	Sliding <input type="checkbox"/>	
	<b>LEGS</b>	Wood <input type="checkbox"/>	Metal <input checked="" type="checkbox"/>	Plastic <input type="checkbox"/>	Castors <input type="checkbox"/>	Upholstered <input type="checkbox"/>	

NOTES

- Tight Seat Cushion (the seat cushions of the models are fixed to the frame)
- Tight Back Cushion (the back cushions of the models are fixed to the frame)
- Internal wooden frame.
- Feet will be in a bag inside the package and requires assembling.
- Metal base available in finishing 75 (Glazed Nickel)

NOTES

---



■ Vers. 009



■ Vers. 016+076+217



■ Vers. 016+049



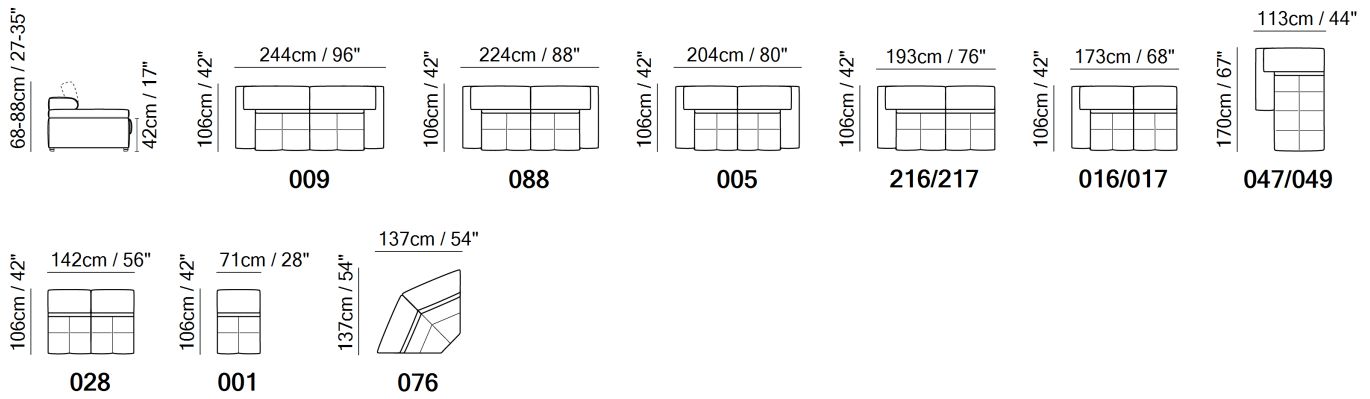

## SCHEMATICS

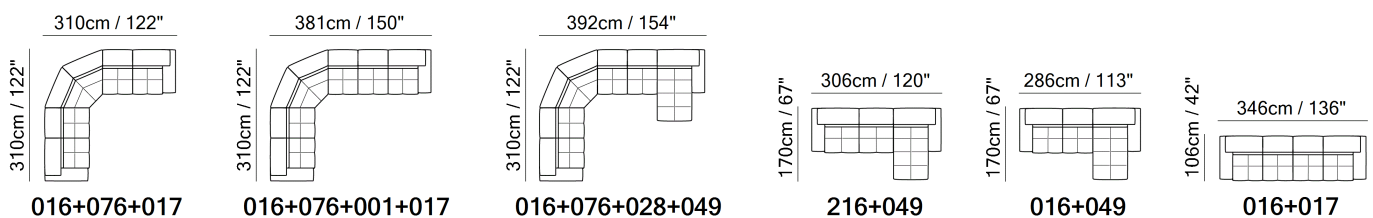

## COMPOSITION EXAMPLES



TECHNICAL INFORMATION

	<b>COVERING</b>	Leather <input checked="" type="checkbox"/>				
	<b>FILLING</b>	<b>Arms</b> <input type="checkbox"/> Fiber <input checked="" type="checkbox"/> Foam <input type="checkbox"/> Feather/Fiber Mix <input type="checkbox"/> Feather	<b>Seat cushion</b> <input type="checkbox"/> Fiber <input checked="" type="checkbox"/> Foam <input type="checkbox"/> Feather/Fiber Mix <input type="checkbox"/> Feather	<b>Back cushion</b> <input type="checkbox"/> Fiber <input checked="" type="checkbox"/> Foam <input type="checkbox"/> Feather/Fiber Mix <input type="checkbox"/> Feather		
	<b>COMFORT</b>	Standard Comfort <input checked="" type="checkbox"/>	Firm Comfort <input type="checkbox"/>			
	<b>FUNCTION</b>	Bed <input type="checkbox"/>	Electric motion <input type="checkbox"/>	Motion <input type="checkbox"/>	Recliner <input type="checkbox"/>	Sliding <input type="checkbox"/>
	<b>LEGS</b>	Wood <input checked="" type="checkbox"/>	Plastic <input type="checkbox"/>	Metal <input type="checkbox"/>	Upholstered <input type="checkbox"/>	Castors <input type="checkbox"/>

NOTES

- Designed by Natuzzi Design Center.
- Date of launch: 2009.
- Avana is one of our most popular models and an original Natuzzi Style Centre design. It is characterised by its modern edge and finer details, such as the tufting on the seat, the rounded metal framing around the armrest and metal insert in the wooden foot.
- Unmatched relaxation, thanks to its comfortable seat and adjustable headrests.
- Contrast stitching is available only with certain covers and option is managed directly in NARES.
- Adjustable headrest on all versions except for the corner item in the sectional
- Round arm and headrest kit are available in metal finishings 75 (Glazed Nickel) / 77 (Glossy Chromed)
- Tight Seat Cushion (the seat cushions of the models are fixed to the frame)
- Tight Back Cushion (the back cushions of the models are fixed to the frame)
- No Leather/Fabric Side (the sectional pieces have the side covered with lining and not leather nor fabric)
- Internal wooden frame.
- Feet will be in a bag inside the package and requires assembling.
- Feet available in wood finishings 09 (Walnut) / 18 (Wengè)
- Feet height 4,5 cm

NOTES

---



■ Vers. 004



■ Vers. 004



■ Vers. 004

SCHEMATICS

---

105cm / 41"



47cm / 19"

93cm / 37"

79cm / 31"



003





93-167cm / 37-66"



004

81cm / 32"

TECHNICAL INFORMATION

	<b>COVERING</b>	Leather <input checked="" type="checkbox"/>	Soft Cover <input checked="" type="checkbox"/>				
	<b>FILLING</b>	Arms	<input type="checkbox"/> Fiber <input checked="" type="checkbox"/> Foam <input type="checkbox"/> Feather/Fiber Mix <input type="checkbox"/> Feather	Seat cushion	<input type="checkbox"/> Fiber <input checked="" type="checkbox"/> Foam <input type="checkbox"/> Feather/Fiber Mix <input type="checkbox"/> Feather	Back cushion	<input type="checkbox"/> Fiber <input checked="" type="checkbox"/> Foam <input type="checkbox"/> Feather/Fiber Mix <input type="checkbox"/> Feather
	<b>COMFORT</b>	Standard Comfort <input checked="" type="checkbox"/>	Firm Comfort <input checked="" type="checkbox"/>				
	<b>FUNCTION</b>	Bed <input type="checkbox"/>	Electric motion <input type="checkbox"/>	Motion <input type="checkbox"/>	Recliner <input checked="" type="checkbox"/>	Sliding <input type="checkbox"/>	
	<b>LEGS</b>	Wood <input checked="" type="checkbox"/>	Metal <input type="checkbox"/>	Plastic <input type="checkbox"/>	Castors <input type="checkbox"/>	Upholstered <input type="checkbox"/>	

NOTES

- Designed by Natuzzi Design Center.
- Tight Seat Cushion (the seat cushions of the models are fixed to the frame)
- Tight Back Cushion (the back cushions of the models are fixed to the frame)
- Internal wooden frame.
- Feet will be in a bag inside the package and requires assembling.
- Front feet are slightly higher in respect to rear.
- Feet available in wood finishings 09 (Walnut) / 18 (Wengè)
- Feet height 12,0/9,0 cm

**NOTES**

---



■ Vers. 003



■ Vers. 003





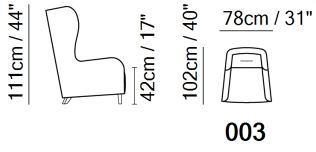

■ Vers. 003

SCHEMATICS

---



TECHNICAL INFORMATION

	<b>COVERING</b>	Leather <input checked="" type="checkbox"/>					
	<b>FILLING</b>	Arms	<input type="checkbox"/> Fiber <input checked="" type="checkbox"/> Foam <input type="checkbox"/> Feather/Fiber Mix <input type="checkbox"/> Feather	Seat cushion	<input type="checkbox"/> Fiber <input checked="" type="checkbox"/> Foam <input type="checkbox"/> Feather/Fiber Mix <input type="checkbox"/> Feather	Back cushion	<input type="checkbox"/> Fiber <input checked="" type="checkbox"/> Foam <input type="checkbox"/> Feather/Fiber Mix <input type="checkbox"/> Feather
	<b>COMFORT</b>	Standard Comfort <input checked="" type="checkbox"/>	Firm Comfort <input type="checkbox"/>				
	<b>FUNCTION</b>	Bed <input type="checkbox"/>	Electric motion <input type="checkbox"/>	Motion <input type="checkbox"/>	Recliner <input type="checkbox"/>	Sliding <input type="checkbox"/>	
	<b>LEGS</b>	Wood <input checked="" type="checkbox"/>	Plastic <input type="checkbox"/>	Metal <input type="checkbox"/>	Upholstered <input type="checkbox"/>	Castors <input type="checkbox"/>	

NOTES

- Designed by Paola Navone.
- Model also available with slipcover with the model code Rxxx.
- Tight Seat Cushion (the seat cushions of the models are fixed to the frame)
- Tight Back Cushion (the back cushions of the models are fixed to the frame)
- Internal wooden frame.
- Feet will be in a bag inside the package and requires assembling.
- Front feet are slightly higher in respect to rear.
- Feet available in wood finishings 09 (Walnut) / 18 (Wengè)
- Feet height 13,0/8,0 cm

NOTES

---



■ Vers. 003



■ Vers. 003





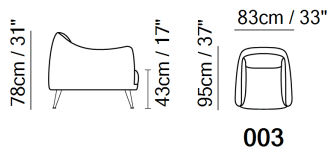

■ Vers. 003

SCHEMATICS

---



TECHNICAL INFORMATION

	<b>COVERING</b>	Leather <input checked="" type="checkbox"/>	Soft Cover <input checked="" type="checkbox"/>				
	<b>FILLING</b>	Arms	<input type="checkbox"/> Fiber <input checked="" type="checkbox"/> Foam <input type="checkbox"/> Feather/Fiber Mix <input type="checkbox"/> Feather	Seat cushion	<input type="checkbox"/> Fiber <input checked="" type="checkbox"/> Foam <input type="checkbox"/> Feather/Fiber Mix <input type="checkbox"/> Feather	Back cushion	<input type="checkbox"/> Fiber <input checked="" type="checkbox"/> Foam <input type="checkbox"/> Feather/Fiber Mix <input type="checkbox"/> Feather
	<b>COMFORT</b>	Standard Comfort <input checked="" type="checkbox"/>	Firm Comfort <input type="checkbox"/>				
	<b>FUNCTION</b>	Bed <input type="checkbox"/>	Electric motion <input type="checkbox"/>	Motion <input type="checkbox"/>	Recliner <input type="checkbox"/>	Sliding <input type="checkbox"/>	
	<b>LEGS</b>	Wood <input type="checkbox"/>	Metal <input checked="" type="checkbox"/>	Plastic <input type="checkbox"/>	Castors <input type="checkbox"/>	Upholstered <input type="checkbox"/>	

NOTES

- Designed by Natuzzi Design Center.
- Tight Seat Cushion (the seat cushions of the models are fixed to the frame)
- Tight Back Cushion (the back cushions of the models are fixed to the frame)
- Internal wooden frame.
- Feet will be in a bag inside the package and requires assembling.
- Feet available in metal finishing 75 (Glazed Nickel)
- Feet height 18,0 cm

NOTES

---



■ Vers. 003



■ Vers. 003





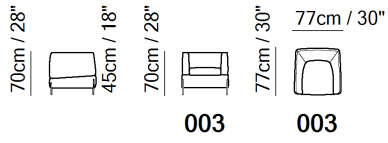

■ Vers. 003

SCHEMATICS

---



**TECHNICAL INFORMATION**

	<b>COVERING</b>	Leather <input checked="" type="checkbox"/>	Soft Cover <input checked="" type="checkbox"/>			
	<b>FILLING</b>	Arms <input type="checkbox"/> Fiber <input checked="" type="checkbox"/> Foam <input type="checkbox"/> Feather/Fiber Mix <input type="checkbox"/> Feather	Seat cushion <input type="checkbox"/> Fiber <input checked="" type="checkbox"/> Foam <input type="checkbox"/> Feather/Fiber Mix <input type="checkbox"/> Feather	Back cushion <input type="checkbox"/> Fiber <input checked="" type="checkbox"/> Foam <input type="checkbox"/> Feather/Fiber Mix <input type="checkbox"/> Feather		
	<b>COMFORT</b>	Standard Comfort <input checked="" type="checkbox"/>	Firm Comfort <input type="checkbox"/>			
	<b>FUNCTION</b>	Bed <input type="checkbox"/>	Electric motion <input type="checkbox"/>	Motion <input type="checkbox"/>	Recliner <input type="checkbox"/>	Sliding <input type="checkbox"/>
	<b>LEGS</b>	Wood <input type="checkbox"/>	Plastic <input type="checkbox"/>	Metal <input checked="" type="checkbox"/>	Upholstered <input type="checkbox"/>	Castors <input type="checkbox"/>

**NOTES**

- Designed by Claudio Bellini.
- Loose Seat Cushion (the seat cushions of the model are not fixed to the frame)
- Tight Back Cushion (the back cushions of the models are fixed to the frame)
- Internal wooden frame.
- With Feet Assembled (the model will be loaded with feet already mounted on the sofa).
- Feet available in metal finishings 77 (Glossy Chromed) / 78 (Black Chrome)
- Feet height 11,5 cm

NOTES

---



■ Vers. 231



■ Vers. 231



■ Vers. 231





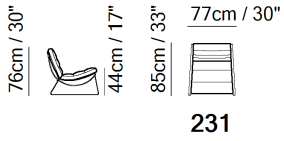

SCHEMATICS

---



**TECHNICAL INFORMATION**

	<b>COVERING</b>	Leather <input checked="" type="checkbox"/>	Soft Cover <input checked="" type="checkbox"/>			
	<b>FILLING</b>	Arms <input type="checkbox"/> Fiber <input checked="" type="checkbox"/> Foam <input type="checkbox"/> Feather/Fiber Mix <input type="checkbox"/> Feather	Seat cushion <input type="checkbox"/> Fiber <input checked="" type="checkbox"/> Foam <input type="checkbox"/> Feather/Fiber Mix <input type="checkbox"/> Feather	Back cushion <input type="checkbox"/> Fiber <input checked="" type="checkbox"/> Foam <input type="checkbox"/> Feather/Fiber Mix <input type="checkbox"/> Feather		
	<b>COMFORT</b>	Standard Comfort <input checked="" type="checkbox"/>	Firm Comfort <input type="checkbox"/>			
	<b>FUNCTION</b>	Bed <input type="checkbox"/>	Electric motion <input type="checkbox"/>	Motion <input type="checkbox"/>	Recliner <input type="checkbox"/>	Sliding <input type="checkbox"/>
	<b>LEGS</b>	Wood <input type="checkbox"/>	Metal <input checked="" type="checkbox"/>	Plastic <input type="checkbox"/>	Castors <input type="checkbox"/>	Upholstered <input type="checkbox"/>

**NOTES**

- Designed by Tapinassi & Manzoni.
- Date of launch: 2011.
- Seat cushion zippered (the seat cushion is attached to the frame through a zipper)
- Back Cushion Zippered (the back cushion is attached to the frame through a zipper)
- With Feet Assembled (the model will be loaded with feet already mounted on the sofa).
- Feet available in metal finish 77 (Glossy Chrome) and 57 (Rugged Cocoa).
- Metal Frame
- For order entry purposes, specify color (01) White, (02) Black or (03) Dark Brown for outside back cover.

NOTES

---



■ Vers. 010



■ Vers. 100





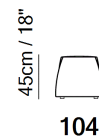
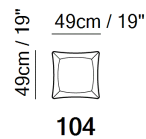
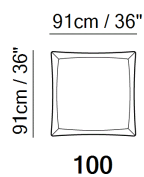
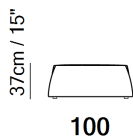
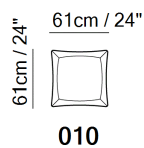
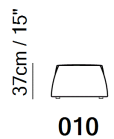

■ Vers. 104

## SCHEMATICS

---



TECHNICAL INFORMATION

	<b>COVERING</b>	Leather <input checked="" type="checkbox"/>	Soft Cover <input checked="" type="checkbox"/>				
	<b>FILLING</b>	Arms	<input type="checkbox"/> Fiber <input checked="" type="checkbox"/> Foam <input type="checkbox"/> Feather/Fiber Mix <input type="checkbox"/> Feather	Seat cushion	<input type="checkbox"/> Fiber <input checked="" type="checkbox"/> Foam <input type="checkbox"/> Feather/Fiber Mix <input type="checkbox"/> Feather	Back cushion	<input type="checkbox"/> Fiber <input checked="" type="checkbox"/> Foam <input type="checkbox"/> Feather/Fiber Mix <input type="checkbox"/> Feather
	<b>COMFORT</b>	Standard Comfort <input checked="" type="checkbox"/>	Firm Comfort <input type="checkbox"/>				
	<b>FUNCTION</b>	Bed <input type="checkbox"/>	Electric motion <input type="checkbox"/>	Motion <input type="checkbox"/>	Recliner <input type="checkbox"/>	Sliding <input type="checkbox"/>	
	<b>LEGS</b>	Wood <input type="checkbox"/>	Plastic <input checked="" type="checkbox"/>	Metal <input type="checkbox"/>	Upholstered <input type="checkbox"/>	Castors <input checked="" type="checkbox"/>	

NOTES

- Stitching is always in taupe.
- Internal wooden frame.
- Feet will be in a bag inside the package and requires assembling.
- Feet height 2,0 cm

NOTES

---



■ Vers. 264



■ Vers. 264



■ Vers. 264



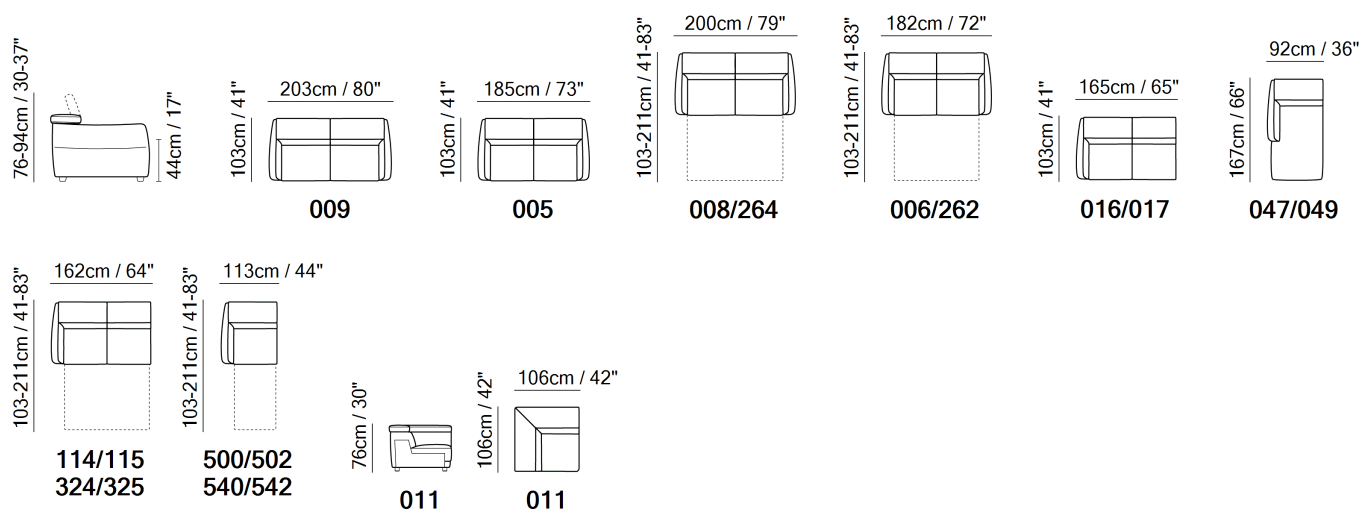

## SCHEMATICS

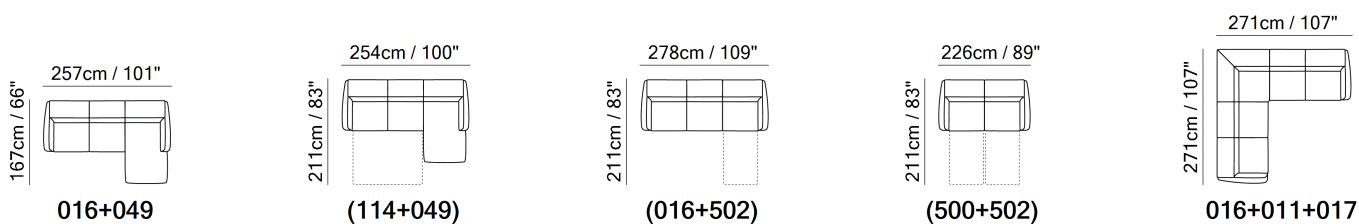

## COMPOSITION EXAMPLES



TECHNICAL INFORMATION

	<b>COVERING</b>	Leather <input checked="" type="checkbox"/>	Soft Cover <input checked="" type="checkbox"/>				
	<b>FILLING</b>	Arms	<input type="checkbox"/> Fiber <input checked="" type="checkbox"/> Foam <input type="checkbox"/> Feather/Fiber Mix <input type="checkbox"/> Feather	Seat cushion	<input type="checkbox"/> Fiber <input checked="" type="checkbox"/> Foam <input type="checkbox"/> Feather/Fiber Mix <input type="checkbox"/> Feather	Back cushion	<input type="checkbox"/> Fiber <input checked="" type="checkbox"/> Foam <input type="checkbox"/> Feather/Fiber Mix <input type="checkbox"/> Feather
	<b>COMFORT</b>	Standard Comfort <input checked="" type="checkbox"/>	Firm Comfort <input checked="" type="checkbox"/>				
	<b>FUNCTION</b>	Bed <input checked="" type="checkbox"/>	Electric motion <input type="checkbox"/>	Motion <input type="checkbox"/>	Recliner <input type="checkbox"/>	Sliding <input type="checkbox"/>	
	<b>LEGS</b>	Wood <input checked="" type="checkbox"/>	Metal <input type="checkbox"/>	Plastic <input type="checkbox"/>	Castors <input type="checkbox"/>	Upholstered <input type="checkbox"/>	

BED MECHANISM & MATTRESS

MECHANISM		MATTRESS		
VERSIONS	TYPE	VERSIONS	TYPE	DIMENSIONS
				W L H
500,502,540,542	Ready-Bed electro-welded - Double folding	500,502	Spring	70 191 13,5
006,114,115,262,324,325	Ready-Bed electro-welded - Double folding	540,542	GREENPLUS	70 193 14
008,264	Ready-Bed electro-welded - Double folding	006,114,115	Polyurethane foam	120 190 13
		262,324,325	GREENPLUS	120 193 14
		008	Polyurethane foam	140 190 13
		264	GREENPLUS	140 193 14

**Ready-Bed electro-welded** The back cushion goes under the bed mechanism.  
**GREENPLUS** GREENPLUS mattress is a patented, innovative product. It is ecological, made up of microporous elastomers. It has a great adaptation capacity to the various body pressure which gives big support to the spine. It is antibacterial and no-allergic.

NOTES

- Designed by Natuzzi Design Center.
- Notturmo is an innovative, one-of-a-kind sofa bed conceptualised for urban living: it has a manually reclinable headrest and turns into a bed with one simple, effortless movement through its "Ready bed" mechanism.
- It's the ideal solution if you're looking for a versatile and quick to convert sofa in a home with limited space.
- It includes storage compartment in the back for pillows.
- With its compact dimensions, Notturmo can adapt easily to different needs.
- Model is not available with article Misterbianco (cat. 30).
- Adjustable headrest on all versions.
- Loose Seat Cushion (the seat cushions of the model are not fixed to the frame)
- Tight Back Cushion (the back cushions of the models are fixed to the frame)
- Internal wooden frame.
- Feet will be in a bag inside the package and requires assembling.

## NOTES

---

- Feet available in wood finishings 09 (Walnut) / 18 (Wengè)
- Feet height 6,5 cm



■ Vers. 064



■ Vers. 018+201



■ Vers. 003



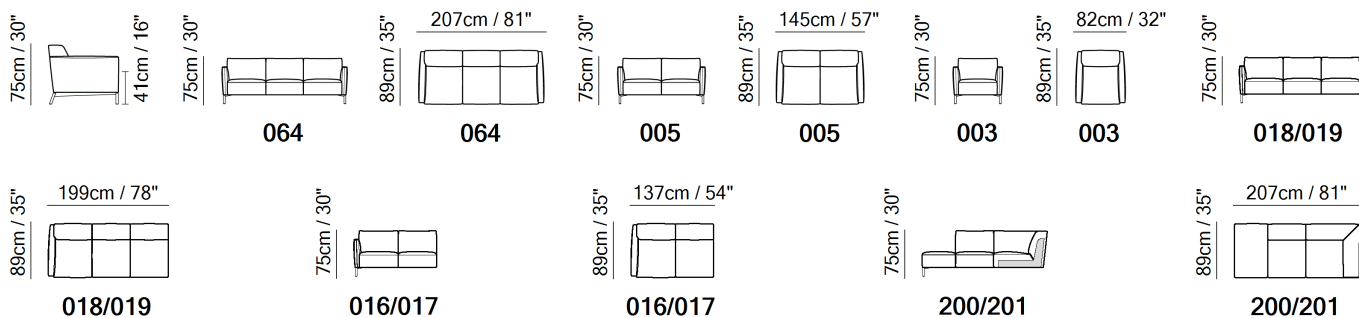

## SCHEMATICS

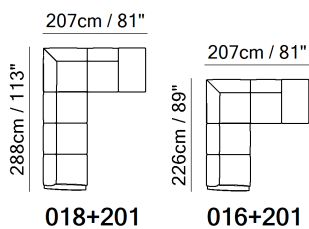

## COMPOSITION EXAMPLES



TECHNICAL INFORMATION

	<b>COVERING</b>	Leather <input checked="" type="checkbox"/>	Soft Cover <input checked="" type="checkbox"/>				
	<b>FILLING</b>	Arms	<input type="checkbox"/> Fiber <input checked="" type="checkbox"/> Foam <input type="checkbox"/> Feather/Fiber Mix <input type="checkbox"/> Feather	Seat cushion	<input type="checkbox"/> Fiber <input checked="" type="checkbox"/> Foam <input type="checkbox"/> Feather/Fiber Mix <input type="checkbox"/> Feather	Back cushion	<input type="checkbox"/> Fiber <input checked="" type="checkbox"/> Foam <input type="checkbox"/> Feather/Fiber Mix <input type="checkbox"/> Feather
	<b>COMFORT</b>	Standard Comfort <input checked="" type="checkbox"/>	Firm Comfort <input type="checkbox"/>				
	<b>FUNCTION</b>	Bed <input type="checkbox"/>	Electric motion <input type="checkbox"/>	Motion <input type="checkbox"/>	Recliner <input type="checkbox"/>	Sliding <input type="checkbox"/>	
	<b>LEGS</b>	Wood <input type="checkbox"/>	Plastic <input type="checkbox"/>	Metal <input checked="" type="checkbox"/>	Upholstered <input type="checkbox"/>	Castors <input type="checkbox"/>	

NOTES

- Designed by Maurizio Manzoni.
- Tratto is the decisive choice for urban living, thanks to its timeless, elegant design and compact size.
- It's characterised by interesting "zig-zag" stitching on the slim arms and the backrest cushions, and the by the special base in glossy chrome metal. Ideal for creating that added value in everyday environments.
- For this model all coverings are available with contrast stitching. If you choose contrast, the stitching is always taupe. If you don't choose contrast, the stitching is tone-on-tone.
- Tight Seat Cushion (the seat cushions of the models are fixed to the frame)
- Tight Back Cushion (the back cushions of the models are fixed to the frame)
- Internal wooden frame.
- Feet will be in a bag inside the package and requires assembling.
- Feet available in metal finishings 77 (Glossy Chromed) / 78 (Black Chrome)
- Feet height 15,0 cm

NOTES

---



■ Vers. 009



■ Vers. 446



■ Vers. 480+183



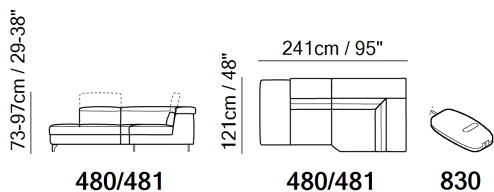
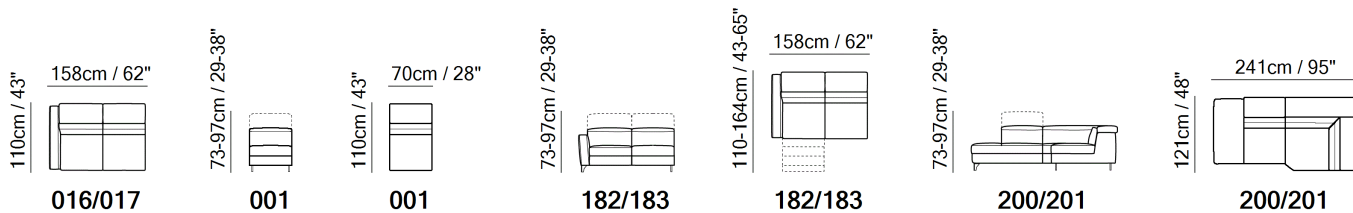
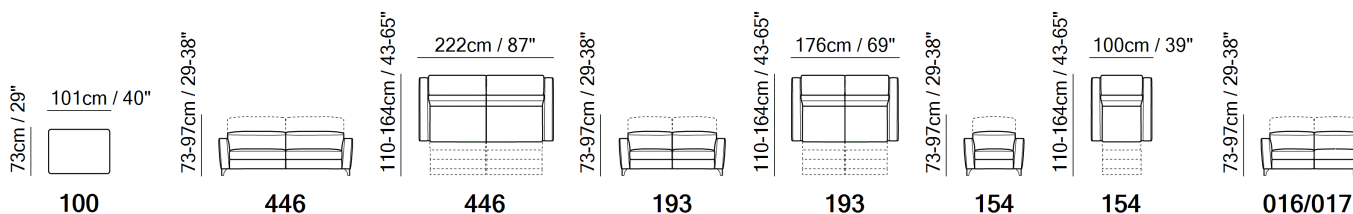
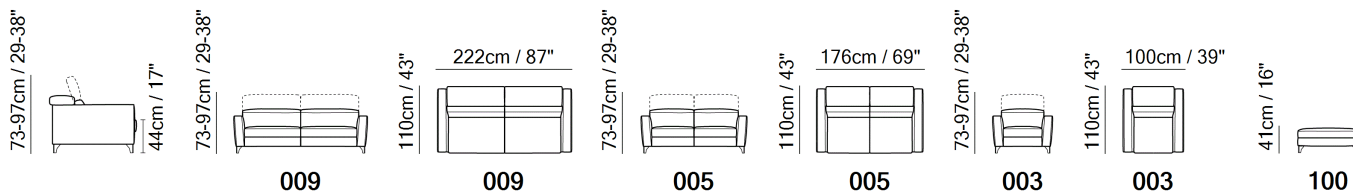

## SCHEMATICS

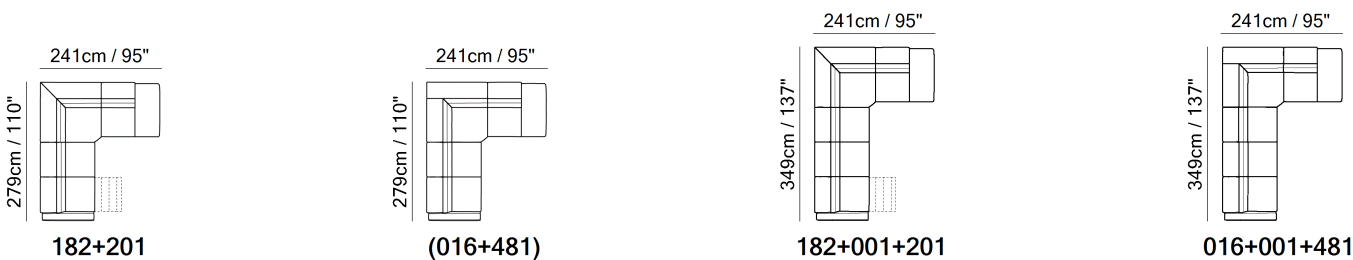

## COMPOSITION EXAMPLES



## TECHNICAL INFORMATION

	<b>COVERING</b>	Leather <input checked="" type="checkbox"/>	Soft Cover <input checked="" type="checkbox"/>				
	<b>FILLING</b>	Arms	<input type="checkbox"/> Fiber <input checked="" type="checkbox"/> Foam <input type="checkbox"/> Feather/Fiber Mix <input type="checkbox"/> Feather	Seat cushion	<input type="checkbox"/> Fiber <input checked="" type="checkbox"/> Foam <input type="checkbox"/> Feather/Fiber Mix <input type="checkbox"/> Feather	Back cushion	<input type="checkbox"/> Fiber <input checked="" type="checkbox"/> Foam <input type="checkbox"/> Feather/Fiber Mix <input type="checkbox"/> Feather
	<b>COMFORT</b>	Standard Comfort <input checked="" type="checkbox"/>	Firm Comfort <input checked="" type="checkbox"/>				
	<b>FUNCTION</b>	Bed <input type="checkbox"/>	Electric motion <input checked="" type="checkbox"/>	Motion <input checked="" type="checkbox"/>	Recliner <input checked="" type="checkbox"/>	Sliding <input type="checkbox"/>	
	<b>LEGS</b>	Wood <input type="checkbox"/>	Metal <input checked="" type="checkbox"/>	Plastic <input type="checkbox"/>	Castors <input type="checkbox"/>	Upholstered <input type="checkbox"/>	

## NOTES

- Designed by Natuzzi Design Center.
- Compact proportions and its high versatility make the model named 'Volo' in Italian the ideal choice for your environment.
- This sofa is the perfect balance of comfort, function and style.
- Thanks to ZeroWall mechanism, seat and back cushions can be reclined at a great length without moving sofa away from the wall.
- Adjustable headrest on all versions.
- Model has power combined headrest. ATTENTION! The headrest opens first followed by the footrest; then the headrest has one final extra rotation for comfortable TV watching position.
- Versions 200/201 have one adjustable headrest on the terminal back
- Second option versions 480/481 have 2 adjustable headrests on the left and right terminal backs
- Seat cushion includes a layer of memory foam, a pressure-sensitive soft polyurethane, that recovers its form completely thus giving great comfort.
- A battery pack can be ordered with its own version code 830. For order entry please use XX for category and XXX for cover code. In order to optimize the duration of the battery, it is suggested to order one per each motion seat.
- Contrast stitching is available only with certain covers and option is managed directly in NARES.
- Tight Seat Cushion (the seat cushions of the models are fixed to the frame)
- Tight Back Cushion (the back cushions of the models are fixed to the frame)
- No Leather/Fabric Side (the sectional pieces have the side covered with lining and not leather nor fabric)

## NOTES

---

- Internal wooden frame.
- Feet will be in a bag inside the package and requires assembling.
- Cardboard wrap for the motion versions.
- Feet available in metal finishing 77 (Glossy Chromed)
- Feet height 11,0 cm



■ Vers. 009



■ Vers. 018+481



■ Vers. 016+049



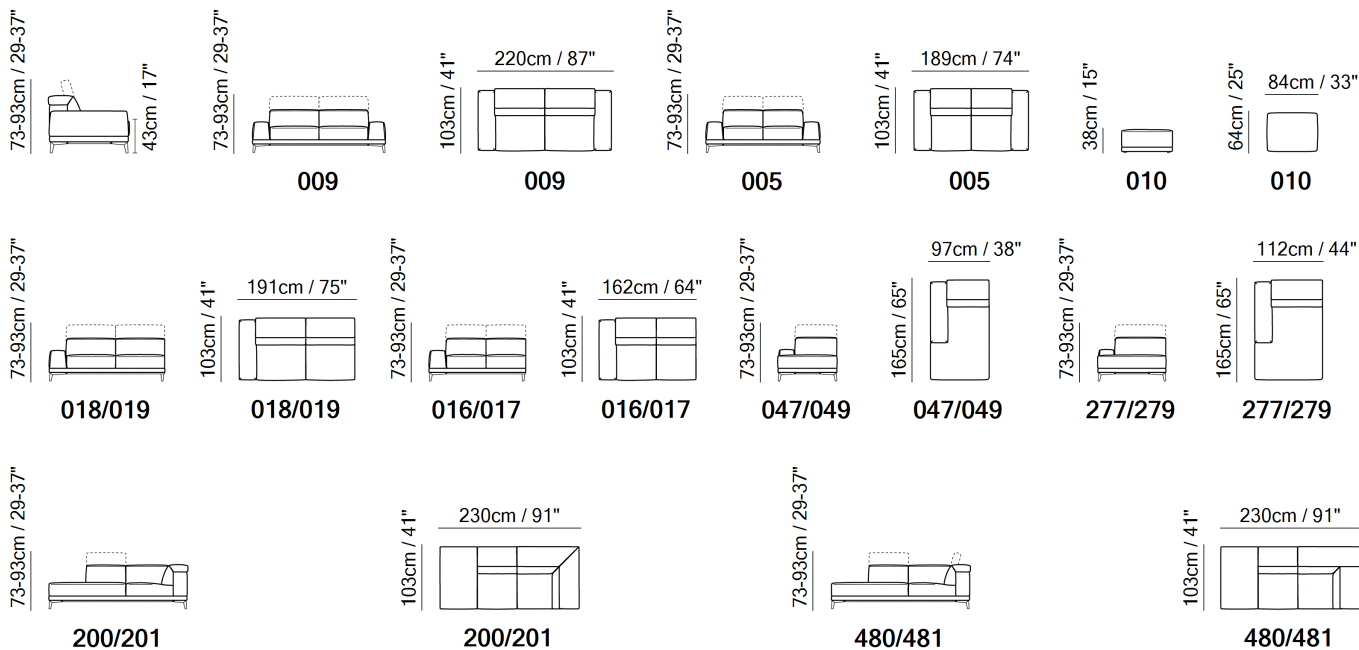

SCHEMATICS

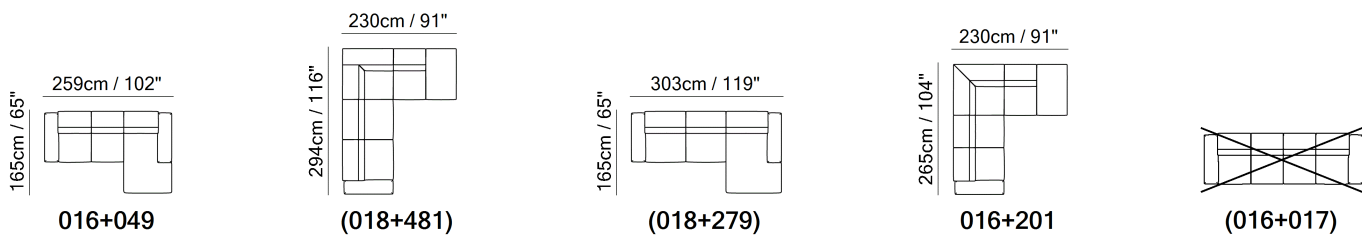

COMPOSITION EXAMPLES



TECHNICAL INFORMATION

	<b>COVERING</b>	Leather <input checked="" type="checkbox"/>	Soft Cover <input checked="" type="checkbox"/>				
	<b>FILLING</b>	Arms	<input type="checkbox"/> Fiber <input checked="" type="checkbox"/> Foam <input type="checkbox"/> Feather/Fiber Mix <input type="checkbox"/> Feather	Seat cushion	<input type="checkbox"/> Fiber <input checked="" type="checkbox"/> Foam <input type="checkbox"/> Feather/Fiber Mix <input type="checkbox"/> Feather	Back cushion	<input type="checkbox"/> Fiber <input checked="" type="checkbox"/> Foam <input type="checkbox"/> Feather/Fiber Mix <input type="checkbox"/> Feather
	<b>COMFORT</b>	Standard Comfort <input checked="" type="checkbox"/>	Firm Comfort <input type="checkbox"/>				
	<b>FUNCTION</b>	Bed <input type="checkbox"/>	Electric motion <input type="checkbox"/>	Motion <input type="checkbox"/>	Recliner <input type="checkbox"/>	Sliding <input type="checkbox"/>	
	<b>LEGS</b>	Wood <input checked="" type="checkbox"/>	Plastic <input type="checkbox"/>	Metal <input type="checkbox"/>	Upholstered <input type="checkbox"/>	Castors <input type="checkbox"/>	

NOTES

- Designed by Natuzzi Design Center.
- A sophisticated design, boasting soft shapes and adjustable headrests for superb comfort without compromising style.
- Borghese's open base comes in either wood or metal and is a sofa feature that together with the detailed stitching on the arm, will make it the standout star of the room.
- Model is not available with article Misterbianco (cat. 30).
- Adjustable headrest on all versions.
- Versions 200/201 have one adjustable headrest on the terminal back
- Second option versions 480/481 have 2 adjustable headrests on the left and right terminal backs
- Second option versions of chaise longue (277/279) are wider in respect to standard (047/049).
- 016+017 and 018+019 configurations are not available.
- Seat cushion includes a layer of memory foam, a pressure-sensitive soft polyurethane, that recovers its form completely thus giving great comfort.
- Tight Seat Cushion (the seat cushions of the models are fixed to the frame)
- Tight Back Cushion (the back cushions of the models are fixed to the frame)
- With Leather Side (the sectional pieces come with leather sides)
- Internal wooden frame.
- Feet will be in a bag inside the package and requires assembling.
- Model available with metal base to order as V826.
- Feet available in wood finishing 18 (Wengè)

**NOTES**

---

- Feet height 16,0 cm



■ Vers. 446



■ Vers. 182+049



■ Vers. 264



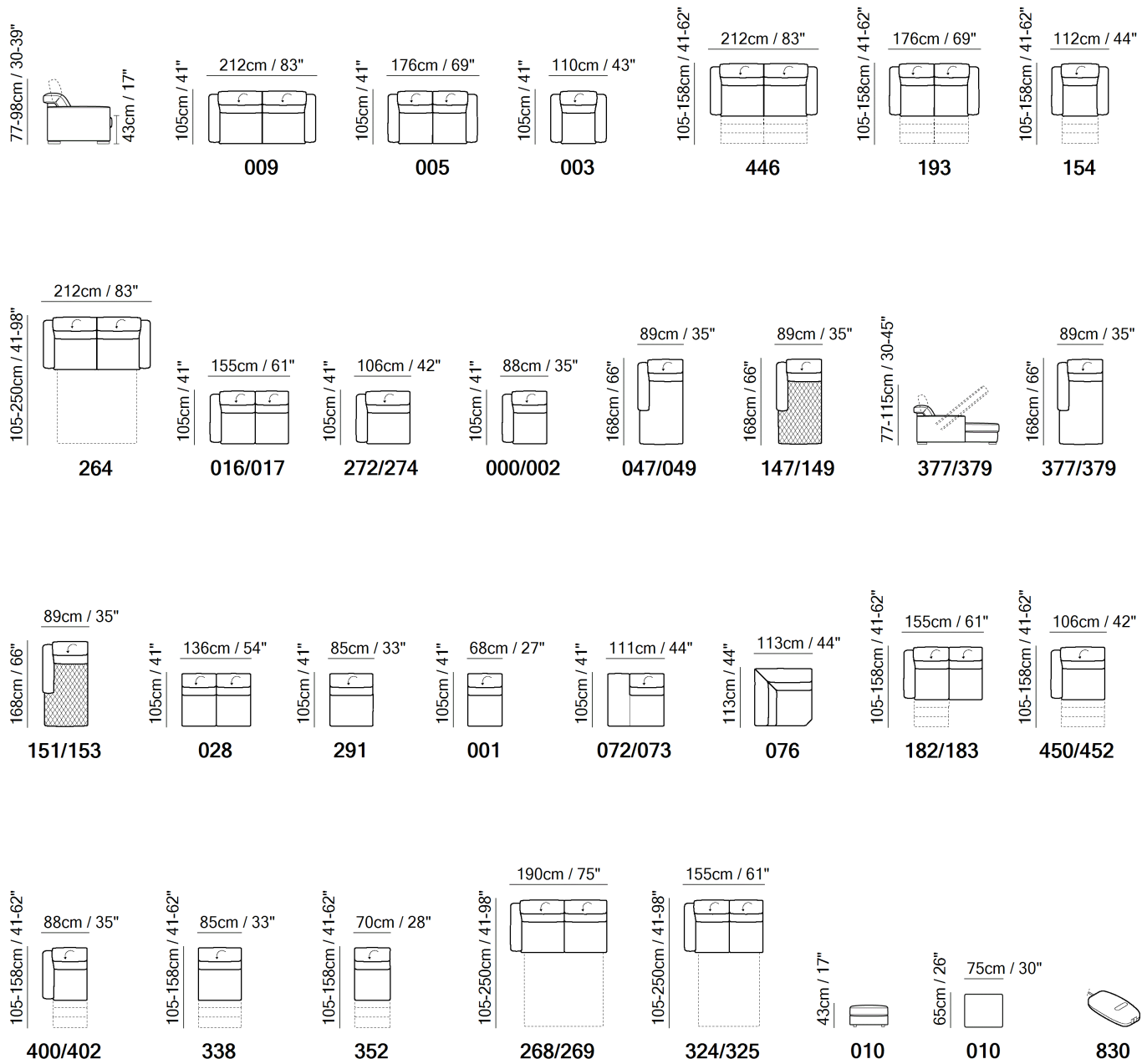

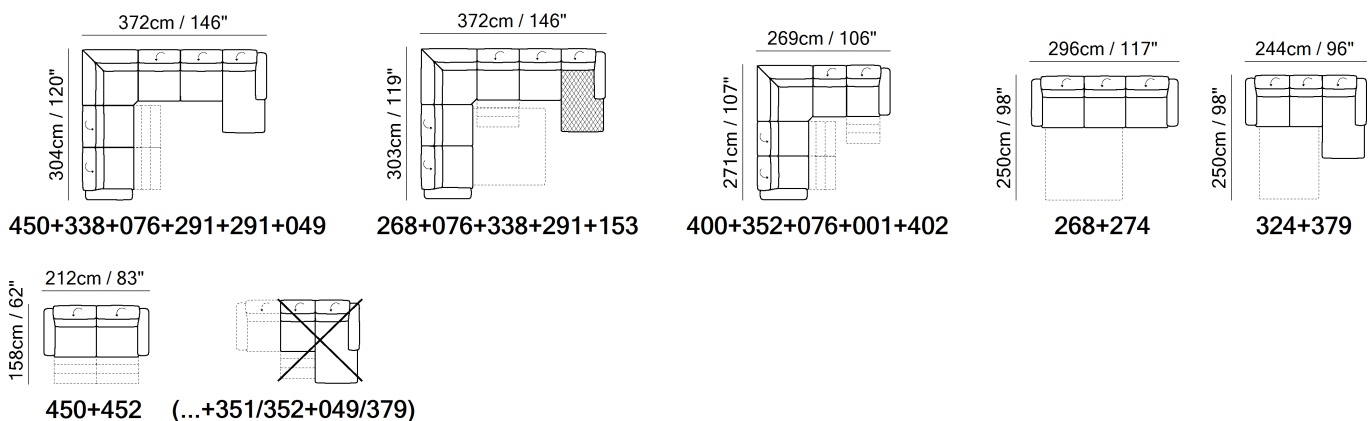

## SCHEMATICS



## COMPOSITION EXAMPLES



TECHNICAL INFORMATION

	<b>COVERING</b>	Leather <input checked="" type="checkbox"/>	Soft Cover <input checked="" type="checkbox"/>			
	<b>FILLING</b>	Arms <input type="checkbox"/> Fiber <input checked="" type="checkbox"/> Foam <input type="checkbox"/> Feather/Fiber Mix <input type="checkbox"/> Feather	Seat cushion <input type="checkbox"/> Fiber <input checked="" type="checkbox"/> Foam <input type="checkbox"/> Feather/Fiber Mix <input type="checkbox"/> Feather	Back cushion <input type="checkbox"/> Fiber <input checked="" type="checkbox"/> Foam <input type="checkbox"/> Feather/Fiber Mix <input type="checkbox"/> Feather		
	<b>COMFORT</b>	Standard Comfort <input checked="" type="checkbox"/>	Firm Comfort <input checked="" type="checkbox"/>			
	<b>FUNCTION</b>	Bed <input checked="" type="checkbox"/>	Electric motion <input checked="" type="checkbox"/>	Motion <input checked="" type="checkbox"/>	Recliner <input checked="" type="checkbox"/>	Sliding <input type="checkbox"/>
	<b>VISUAL APPEARANCE*</b>	Low <input type="checkbox"/>	Medium <input checked="" type="checkbox"/>	High <input type="checkbox"/>		
	<b>LEGS</b>	Wood <input checked="" type="checkbox"/>	Metal <input type="checkbox"/>	Plastic <input type="checkbox"/>	Castors <input type="checkbox"/>	Upholstered <input type="checkbox"/>

VISUAL APPEARANCE

The product may reveal various wrinkles due to the combination of Elasticity of the covering, characteristics of the interior construction and the design of the product.



Products with Visual Appearance listed as High or Medium would require higher degree of care, where seats and back cushions may require fluffing and plumping more often than Products with Visual Appearance listed as Low.

BED MECHANISM & MATTRESS

MECHANISM		MATTRESS		
VERSIONS	TYPE	VERSIONS	TYPE	DIMENSIONS
324,325	Transformable electro-welded - Double folding	324,325	GREENPLUS	W L H 100 190 12
264,268,269	Transformable electro-welded - Double folding	264,268,269	GREENPLUS	140 193 12

**Transformable electro-welded** The back cushion remains fixed at the head, creating a comfortable support.  
**GREENPLUS** GREENPLUS mattress is a patented, innovative product. It is ecological, made up of microporous elastomers. It has a great adaptation capacity to the various body pressure which gives big support to the spine. It is antibacterial and no-allergic.

NOTES

- Designed by Natuzzi Design Center.
- Date of launch: 2013.
- The Diesis sofa is compact and ideal for apartment living . Features include special piping detail on the armrest and subtle wooden feet. Perfect combination of technology and relax by Natuzzi Italia.
- Model is not available with article Misterbianco (cat. 30).
- Model is available with contrast welt (or any another decorative detail such as a band under arm cushion) to be entered as second covering in the same category.
- It's also available as a sofa bed with the innovative Greenplus mattress.
- The model has internal soft touch buttons on the seat to activate the mechanism.
- Thanks to ZeroWall mechanism, seat and back cushions can be reclined at a great length without moving sofa away from the wall.

NOTES

---

- Adjustable headrest on all versions except for the corner item in the sectional
- The model has manual adjustable headrest.
- Model is available with chaise lounge (vers. 377-379) with storage.
- Following versions cannot to be ordered next to the corner (011) or chaise longue (047/049 - 377/379) : 338/328 - 450/452 - 360/362.
- A battery pack can be ordered with its own version code 830. For order entry please use XX for category and XXX for cover code. In order to optimize the duration of the battery, it is suggested to order one per each motion seat.
- Seat and back cushions are fixed to the frame.
- No Leather/Fabric Side (the sectional pieces have the side covered with lining and not leather nor fabric)
- Internal wooden frame.
- Feet available in wood finishings 09 (Walnut) / 18 (Wengè)
- Feet will be in a bag inside the package and requires assembling.
- Feet height 4,5 cm
- Following versions cannot to be ordered next to the corner (011) or chaise longue (047/049 - 377/379) : 338/328 - 450/452 - 360/362.



■ Vers. 009



■ Vers. 277+019



■ Vers. 200+019



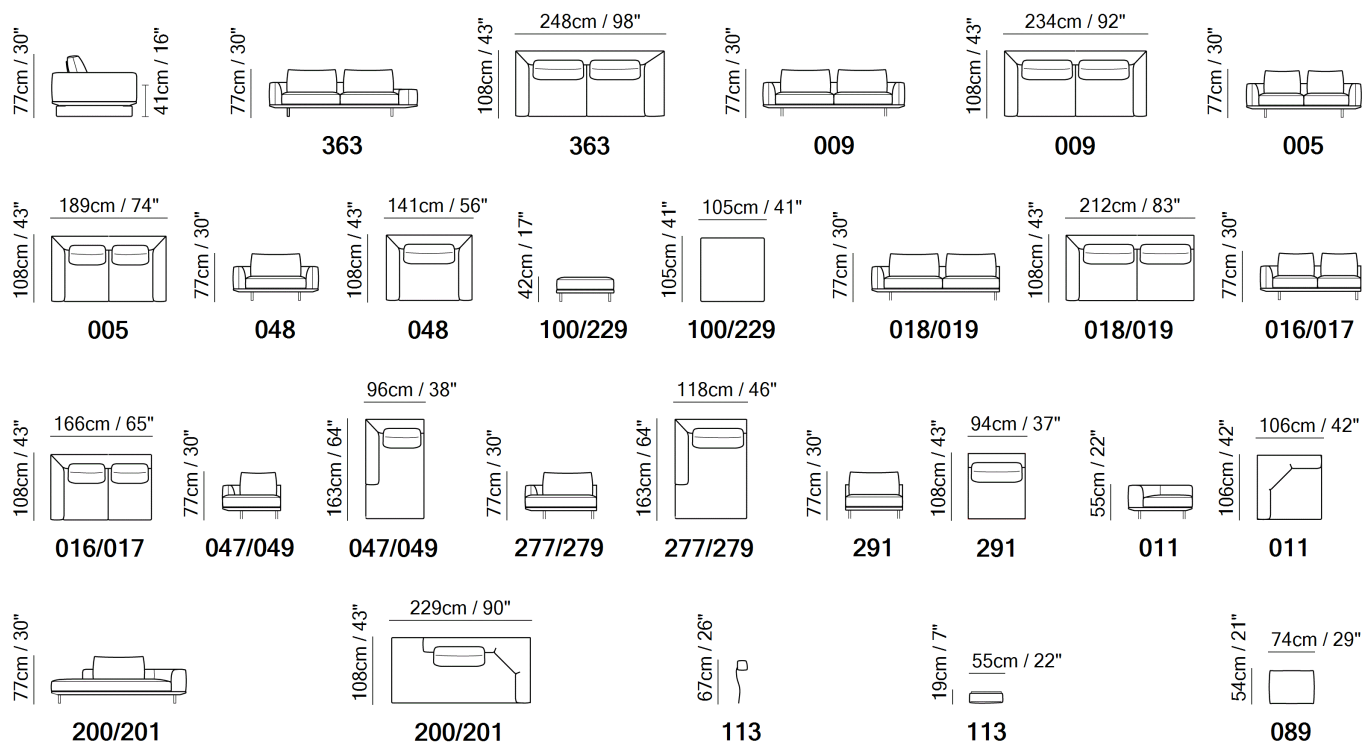

## SCHEMATICS

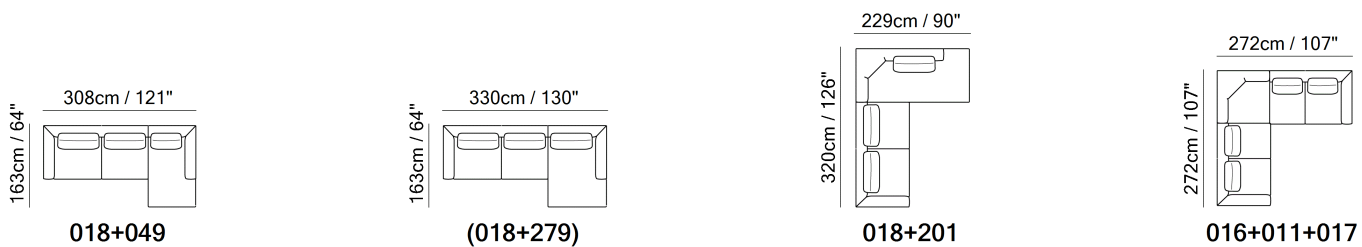

## COMPOSITION EXAMPLES



TECHNICAL INFORMATION

	<b>COVERING</b>	Leather <input checked="" type="checkbox"/>	Soft Cover <input checked="" type="checkbox"/>				
	<b>FILLING</b>	Arms	<input type="checkbox"/> Fiber <input checked="" type="checkbox"/> Foam <input type="checkbox"/> Feather/Fiber Mix <input type="checkbox"/> Feather	Seat cushion	<input type="checkbox"/> Fiber <input checked="" type="checkbox"/> Foam <input type="checkbox"/> Feather/Fiber Mix <input checked="" type="checkbox"/> Feather	Back cushion	<input type="checkbox"/> Fiber <input checked="" type="checkbox"/> Foam <input type="checkbox"/> Feather/Fiber Mix <input checked="" type="checkbox"/> Feather
	<b>COMFORT</b>	Standard Comfort <input checked="" type="checkbox"/>	Firm Comfort <input type="checkbox"/>				
	<b>FUNCTION</b>	Bed <input type="checkbox"/>	Electric motion <input type="checkbox"/>	Motion <input type="checkbox"/>	Recliner <input type="checkbox"/>	Sliding <input type="checkbox"/>	
	<b>LEGS</b>	Wood <input type="checkbox"/>	Plastic <input type="checkbox"/>	Metal <input checked="" type="checkbox"/>	Upholstered <input type="checkbox"/>	Castors <input type="checkbox"/>	

NOTES

- Designed by Italian architects Manzoni and Tapinassi, based on Time being marked by a sophisticated and timeless design.
- Tempo's versatility makes it perfect for any environment. Sofa designed to fit in with the Tempo tables for an exceptional total look.
- The feet are in a special dark grey powder coated metal finish.
- Model is not available with article Misterbianco (cat. 30).
- For this model all leathers are available with contrast stitching. If you choose contrast, the stitching is always taupe. If you don't choose contrast, the stitching is tone-on-tone.
- Seat cushion includes a layer of memory foam, a pressure-sensitive soft polyurethane, that recovers its form completely thus giving great comfort.
- Second option versions of chaise longue (277/279) are wider in respect to standard (047/049).
- Arms of version 363 are different from eachother both for dimension and aesthetics
- Loose Seat Cushion (the seat cushions of the model are not fixed to the frame)
- Loose Back Cushion (the back cushions of the model are not fixed to the frame)
- With Leather Side (the sectional pieces come with leather sides)
- Internal wooden frame.
- Feet will be in a bag inside the package and requires assembling.
- Feet available in unique metal finishing powder coated dark grey
- Feet height 14,0 cm

NOTES

---



■ Vers. 003



■ Vers. 003





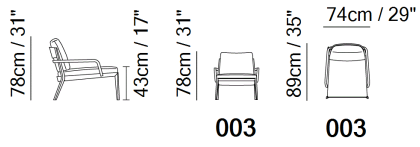

■ Vers.

SCHEMATICS

---



TECHNICAL INFORMATION

	<b>COVERING</b>	Leather <input checked="" type="checkbox"/>	Soft Cover <input checked="" type="checkbox"/>				
	<b>FILLING</b>	Arms	<input type="checkbox"/> Fiber <input checked="" type="checkbox"/> Foam <input type="checkbox"/> Feather/Fiber Mix <input type="checkbox"/> Feather	Seat cushion	<input type="checkbox"/> Fiber <input checked="" type="checkbox"/> Foam <input type="checkbox"/> Feather/Fiber Mix <input checked="" type="checkbox"/> Feather	Back cushion	<input type="checkbox"/> Fiber <input checked="" type="checkbox"/> Foam <input type="checkbox"/> Feather/Fiber Mix <input checked="" type="checkbox"/> Feather
	<b>COMFORT</b>	Standard Comfort <input checked="" type="checkbox"/>	Firm Comfort <input checked="" type="checkbox"/>				
	<b>FUNCTION</b>	Bed <input type="checkbox"/>	Electric motion <input type="checkbox"/>	Motion <input type="checkbox"/>	Recliner <input type="checkbox"/>	Sliding <input type="checkbox"/>	
	<b>LEGS</b>	Wood <input checked="" type="checkbox"/>	Metal <input type="checkbox"/>	Plastic <input type="checkbox"/>	Castors <input type="checkbox"/>	Upholstered <input type="checkbox"/>	

NOTES

- Designed by Tapinassi & Manzoni.
- Date of launch: 2013.
- Tight Seat Cushion (the seat cushions of the models are fixed to the frame)
- Loose Back Cushion (the back cushions of the model are not fixed to the frame)
- Internal wooden frame.
- With Feet Assembled (the model will be loaded with feet already mounted on the sofa).
- Front feet are slightly higher in respect to rear.
- Arms are available in metal with finishing lacquered coffee with Wengè 18 frame or in lacquered beige with Honey Ashwood 55 frame.
- Feet available in wooden finish 18 (Wengè) e 55 (Honey ashwood).
- Feet height 26,0/19,0 cm

NOTES

---



■ Vers. 001+033+038+057



■ Vers. 001+033+038+057



■ Vers. 001+033+038+057



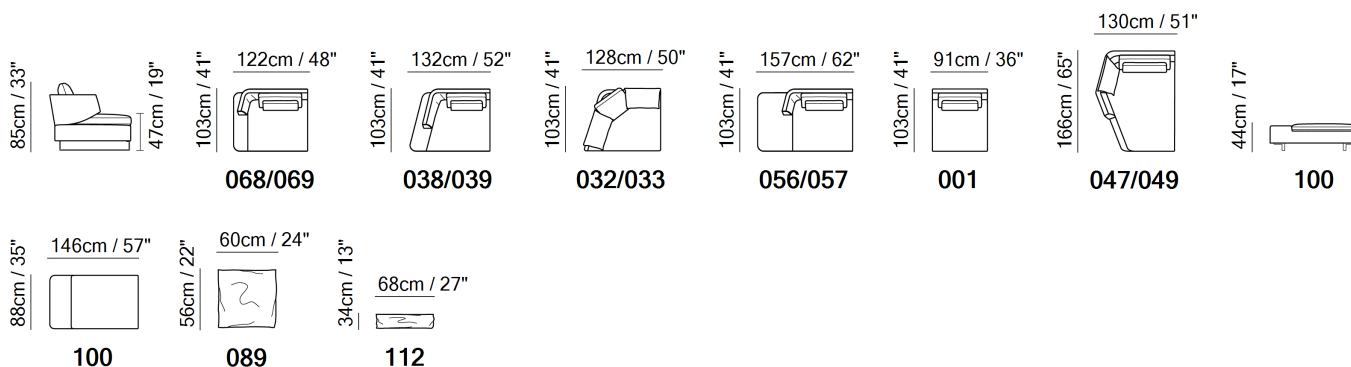

## SCHEMATICS

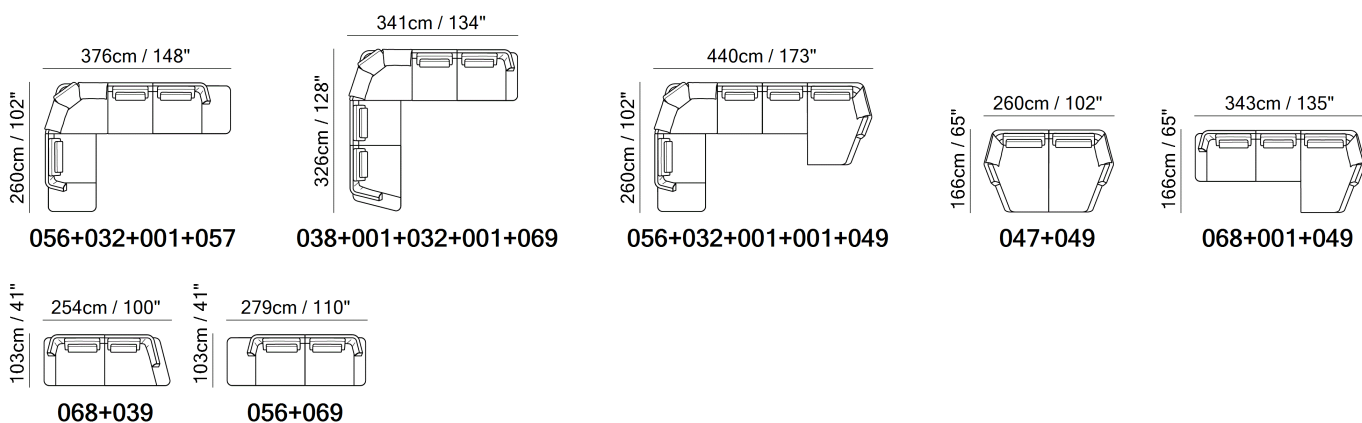

## COMPOSITION EXAMPLES



TECHNICAL INFORMATION

	<b>COVERING</b>	Mix <input checked="" type="checkbox"/>	Leather <input checked="" type="checkbox"/>	Soft Cover <input checked="" type="checkbox"/>		
	<b>FILLING</b>	Arms <input type="checkbox"/> Fiber <input checked="" type="checkbox"/> Foam <input type="checkbox"/> Feather/Fiber Mix <input type="checkbox"/> Feather	Seat cushion <input type="checkbox"/> Fiber <input checked="" type="checkbox"/> Foam <input type="checkbox"/> Feather/Fiber Mix <input checked="" type="checkbox"/> Feather	Back cushion <input type="checkbox"/> Fiber <input checked="" type="checkbox"/> Foam <input type="checkbox"/> Feather/Fiber Mix <input checked="" type="checkbox"/> Feather		
	<b>COMFORT</b>	Standard Comfort <input checked="" type="checkbox"/>	Firm Comfort <input type="checkbox"/>			
	<b>FUNCTION</b>	Bed <input type="checkbox"/>	Electric motion <input type="checkbox"/>	Motion <input type="checkbox"/>	Recliner <input type="checkbox"/>	Sliding <input type="checkbox"/>
	<b>LEGS</b>	Wood <input type="checkbox"/>	Plastic <input type="checkbox"/>	Metal <input checked="" type="checkbox"/>	Upholstered <input type="checkbox"/>	Castors <input type="checkbox"/>

NOTES

- Elegant, modern and especially versatile. The ample seat and the loose lumbar cushions with goose down fill, offer snug comfort.
- Opus features a special design in the armrest's extension, suspended by the backrest, the base metallic feet, giving the model a floating look.
- Model is not available with article Misterbianco (cat. 30).
- To allow modularity, the single elements can be put together thanks to the rubber stops under the legs.
- 
- Seat cushion includes a layer of memory foam, a pressure-sensitive soft polyurethane, that recovers its form completely thus giving great comfort.
- Seat cushion zippered (the seat cushion is attached to the frame through a zipper)
- Back Cushion Zippered (the back cushion is attached to the frame through a zipper)
- Internal wooden frame.
- Feet will be in a bag inside the package and requires assembling.
- Feet available in metal finishings 75 (Glazed Nickel) / 77 (Glossy Chrome)
- Feet height 12,0 cm
- Versions 001/056/057/068/069 include 1 kidney pillow.
- Versions 032/033 include 2 small cushions and 1 large cushion.
- Versions 038/039 include 1 small cushion.
- Versions 047/049 include 1 small cushion and 1 kidney pillow.
- LEATHER-FABRIC MIX COVERING OPTIONS:
- 1° COV. (Leather) = Frame

## NOTES

---

- 2° COV. (Fabric) = Seat and back cushions
- 3° COV. (Fabric) = Small cushion / kidney pillow
- THREE TONE COVERING OPTION IN FABRIC:
- 1° COV. = Frame
- 2° COV. = Seat and back cushions
- 3° COV. = Small cushion / kidney pillows



■ Vers. 003



■ Vers. 003



■ Vers. 066

## SCHEMATICS

---



003

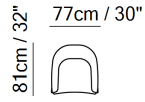

003



066





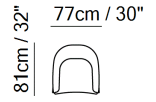

066



066

## TECHNICAL INFORMATION

	<b>COVERING</b>	Mix <input checked="" type="checkbox"/>	Leather <input checked="" type="checkbox"/>	Soft Cover <input checked="" type="checkbox"/>			
	<b>FILLING</b>	Arms	<input type="checkbox"/> Fiber <input checked="" type="checkbox"/> Foam <input type="checkbox"/> Feather/Fiber Mix <input type="checkbox"/> Feather	Seat cushion	<input type="checkbox"/> Fiber <input checked="" type="checkbox"/> Foam <input type="checkbox"/> Feather/Fiber Mix <input type="checkbox"/> Feather	Back cushion	<input type="checkbox"/> Fiber <input checked="" type="checkbox"/> Foam <input type="checkbox"/> Feather/Fiber Mix <input type="checkbox"/> Feather
	<b>COMFORT</b>	Standard Comfort <input checked="" type="checkbox"/>	Firm Comfort <input type="checkbox"/>				
	<b>FUNCTION</b>	Bed <input type="checkbox"/>	Electric motion <input type="checkbox"/>	Motion <input type="checkbox"/>	Recliner <input type="checkbox"/>	Sliding <input type="checkbox"/>	
	<b>LEGS</b>	Wood <input type="checkbox"/>	Metal <input type="checkbox"/>	Plastic <input checked="" type="checkbox"/>	Castors <input type="checkbox"/>	Upholstered <input type="checkbox"/>	

## NOTES

- Leather/Fabric MIX CATEGORIES are based on the STARTING PRICE CATEGORY OF LEATHER combined with fabric = cat. 1A (cat.10 + fabric) - 1B (cat.15 + fabric) - 2A (cat. 20 ...) - 2B (cat. 25 ...) - 3A (cat. 30 ...) - 3B (cat. 35 ...) - 4A (cat. 40 ...) - 5E (cat. 55 ...)
- Seat cushion includes a layer of memory foam, a pressure-sensitive soft polyurethane, that recovers its form completely thus giving great comfort.
- Tight Seat Cushion (the seat cushions of the models are fixed to the frame)
- Tight Back Cushion (the back cushions of the models are fixed to the frame)
- Internal wooden frame.
- Feet will be in a bag inside the package and requires assembling.
- Cardboard wrap for the motion versions.
- Vers. 066: Metal base available in metal finishings 79 (Matte Black)
- Feet height 4,5 cm
- LEATHER-FABRIC MIX COVERING OPTIONS:
- 1° COV. (Leather) = Frame
- 2° COV. (Fabric) = Seat and back cushions

NOTES

---



■ Vers. 529



■ Vers. 529





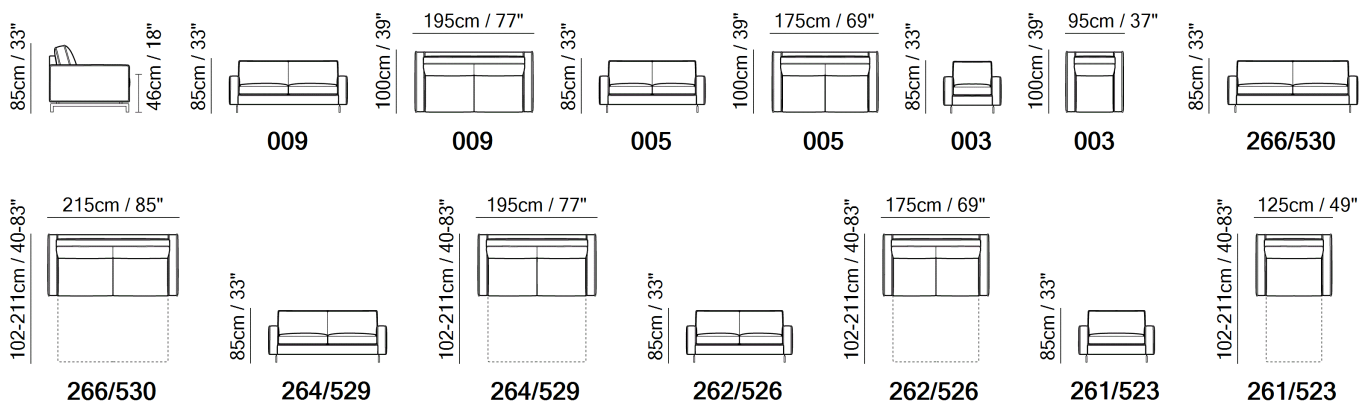

■ Vers. 529

**SCHEMATICS**



TECHNICAL INFORMATION

	<b>COVERING</b>	Leather <input checked="" type="checkbox"/>	Soft Cover <input checked="" type="checkbox"/>			
	<b>FILLING</b>	Arms <input type="checkbox"/> Fiber <input checked="" type="checkbox"/> Foam <input type="checkbox"/> Feather/Fiber Mix <input type="checkbox"/> Feather	Seat cushion <input type="checkbox"/> Fiber <input checked="" type="checkbox"/> Foam <input type="checkbox"/> Feather/Fiber Mix <input type="checkbox"/> Feather	Back cushion <input type="checkbox"/> Fiber <input checked="" type="checkbox"/> Foam <input type="checkbox"/> Feather/Fiber Mix <input type="checkbox"/> Feather		
	<b>COMFORT</b>	Standard Comfort <input checked="" type="checkbox"/>	Firm Comfort <input type="checkbox"/>			
	<b>FUNCTION</b>	Bed <input checked="" type="checkbox"/>	Electric motion <input type="checkbox"/>	Motion <input type="checkbox"/>	Recliner <input type="checkbox"/>	Sliding <input type="checkbox"/>
	<b>LEGS</b>	Wood <input type="checkbox"/>	Plastic <input type="checkbox"/>	Metal <input checked="" type="checkbox"/>	Upholstered <input type="checkbox"/>	Castors <input type="checkbox"/>

BED MECHANISM & MATTRESS

MECHANISM		MATTRESS		
VERSIONS	TYPE	VERSIONS	TYPE	DIMENSIONS
				W L H
262,526	Ready-Bed electro-welded - Double folding	523	Memory	70 185 11
264,529	Ready-Bed electro-welded - Double folding	261	GREENPLUS	70 195 11
266,530	Ready-Bed electro-welded - Double folding	262	GREENPLUS	120 195 11
		526	Memory	120 195 11
		264	GREENPLUS	140 195 11
		529	Memory	140 195 11
		266	GREENPLUS	160 195 11
		530	Memory	160 195 11

**Ready-Bed electro-welded** The back cushion goes under the bed mechanism.  
**Memory** Non-allergic memory mattress available with zippered cover that can be easily taken off and washed.  
**GREENPLUS** GREENPLUS mattress is a patented, innovative product. It is ecological, made up of microporous elastomers. It has a great adaptation capacity to the various body pressure which gives big support to the spine. It is antibacterial and no-allergic.

NOTES

- Designed by Natuzzi Design Center.
- Date of launch: 2014.
- The Capriccio sofa bed, based on square shapes, combines simplicity and elegance for compact urban spaces.
- The model is equipped with pillows stowed away in a space-saving hidden compartment and features include stylish metal feet.
- The "Ready bed" mechanism ensures ease of operation, going from sofa to bed and vice versa in one swift movement.
- Model is available with contrast welt (or any another decorative detail such as a band under arm cushion) to be entered as second covering in the same category.
- Model is not available with article Misterbianco (cat. 30).
- Tight Seat Cushion (the seat cushions of the models are fixed to the frame)

## NOTES

---

- Tight Back Cushion (the back cushions of the models are fixed to the frame)
- Internal wooden frame.
- Feet will be in a bag inside the package and requires assembling.
- Feet available in metal finishings 77 (Glossy Chromed) / 78 (Black Chrome)
- Feet height 13,0 cm



■ Vers. 003



■ Vers. 003



■ Vers. 066

SCHEMATICS

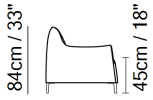

003

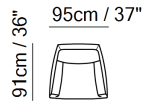

003

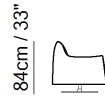

066

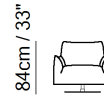



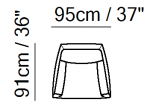

066



066

## TECHNICAL INFORMATION

	<b>COVERING</b>	Leather <input checked="" type="checkbox"/>	Soft Cover <input checked="" type="checkbox"/>				
	<b>FILLING</b>	Arms	<input type="checkbox"/> Fiber <input checked="" type="checkbox"/> Foam <input type="checkbox"/> Feather/Fiber Mix <input type="checkbox"/> Feather	Seat cushion	<input type="checkbox"/> Fiber <input checked="" type="checkbox"/> Foam <input type="checkbox"/> Feather/Fiber Mix <input type="checkbox"/> Feather	Back cushion	<input type="checkbox"/> Fiber <input checked="" type="checkbox"/> Foam <input type="checkbox"/> Feather/Fiber Mix <input type="checkbox"/> Feather
	<b>COMFORT</b>	Standard Comfort <input checked="" type="checkbox"/>	Firm Comfort <input type="checkbox"/>				
	<b>FUNCTION</b>	Bed <input type="checkbox"/>	Electric motion <input type="checkbox"/>	Motion <input type="checkbox"/>	Recliner <input type="checkbox"/>	Sliding <input type="checkbox"/>	
	<b>LEGS</b>	Wood <input type="checkbox"/>	Metal <input checked="" type="checkbox"/>	Plastic <input type="checkbox"/>	Castors <input type="checkbox"/>	Upholstered <input type="checkbox"/>	

## NOTES

- Model is available with contrast welt (or any another decorative detail such as a band under arm cushion) to be entered as second covering in the same category.
- Seat cushion includes a layer of memory foam, a pressure-sensitive soft polyurethane, that recovers its form completely thus giving great comfort.
- Vers. 066: Metal base available in metal finishings 79 (Matte Black)
- Tight Seat Cushion (the seat cushions of the models are fixed to the frame)
- Tight Back Cushion (the back cushions of the models are fixed to the frame)
- Internal wooden frame.
- Feet will be in a bag inside the package and requires assembling.
- Feet available in metal finishings 77 (Glossy Chromed) / 78 (Black Chrome)
- Feet height 13,0 cm

NOTES

---



■ Vers. 272+274



■ Vers. 272+274



■ Vers. 100



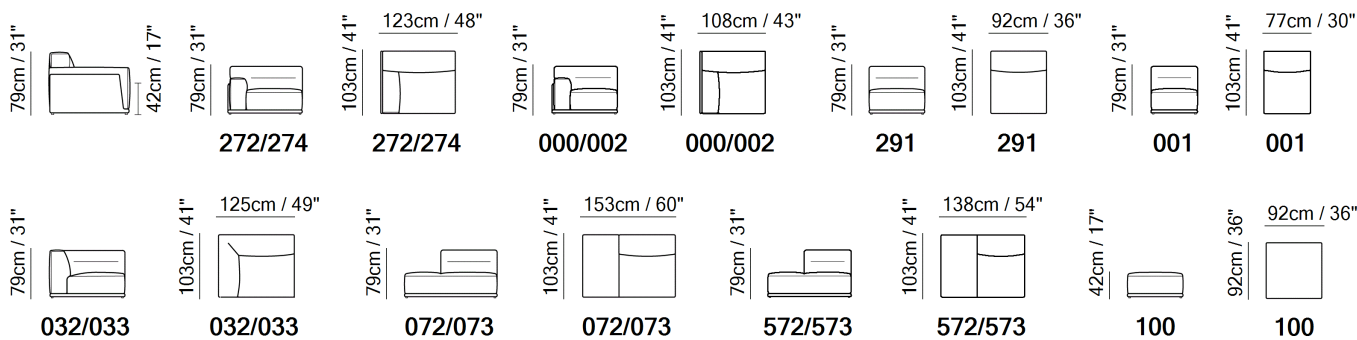

SCHEMATICS

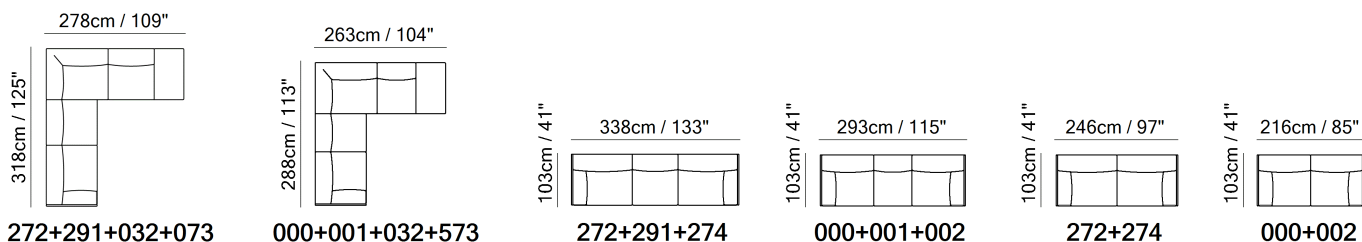

COMPOSITION EXAMPLES



TECHNICAL INFORMATION

	<b>COVERING</b>	Leather <input checked="" type="checkbox"/>	Soft Cover <input checked="" type="checkbox"/>				
	<b>FILLING</b>	Arms	<input type="checkbox"/> Fiber <input checked="" type="checkbox"/> Foam <input type="checkbox"/> Feather/Fiber Mix <input checked="" type="checkbox"/> Feather	Seat cushion	<input type="checkbox"/> Fiber <input checked="" type="checkbox"/> Foam <input type="checkbox"/> Feather/Fiber Mix <input checked="" type="checkbox"/> Feather	Back cushion	<input type="checkbox"/> Fiber <input checked="" type="checkbox"/> Foam <input type="checkbox"/> Feather/Fiber Mix <input checked="" type="checkbox"/> Feather
	<b>COMFORT</b>	Standard Comfort <input checked="" type="checkbox"/>	Firm Comfort <input type="checkbox"/>				
	<b>FUNCTION</b>	Bed <input type="checkbox"/>	Electric motion <input type="checkbox"/>	Motion <input type="checkbox"/>	Recliner <input type="checkbox"/>	Sliding <input type="checkbox"/>	
	<b>LEGS</b>	Wood <input type="checkbox"/>	Plastic <input checked="" type="checkbox"/>	Metal <input type="checkbox"/>	Upholstered <input type="checkbox"/>	Castors <input type="checkbox"/>	

NOTES

- Designed by Tapinassi & Manzoni.
- Date of launch: 2014.
- Dorian will be the main attraction in your living area. The generously proportioned Dorian sofa is both aesthetically impressive and extremely comfortable.
- Model also available with thick leather with model code Sxxx (Art. Cassidy cat.60, Misterbianco cat.30).
- Seat cushion includes a layer of memory foam, a pressure-sensitive soft polyurethane, that recovers its form completely thus giving great comfort.
- To allow modularity, the single elements can be put together thanks to the rubber stops under the legs.
- Seat and back cushions are fixed to the frame.
- In leather version module side panels are fully upholstered.
- Internal wooden frame.
- With Feet Assembled (the model will be loaded with feet already mounted on the sofa).
- The hidden metal feet have anti-scratch and non-slip rubber, providing a hidden practical solution for protecting floors.
- Feet height 3,0 cm

NOTES

---



■ Vers. 272+452



■ Vers. 272+338+452



■ Vers. 182+291+032+291+073



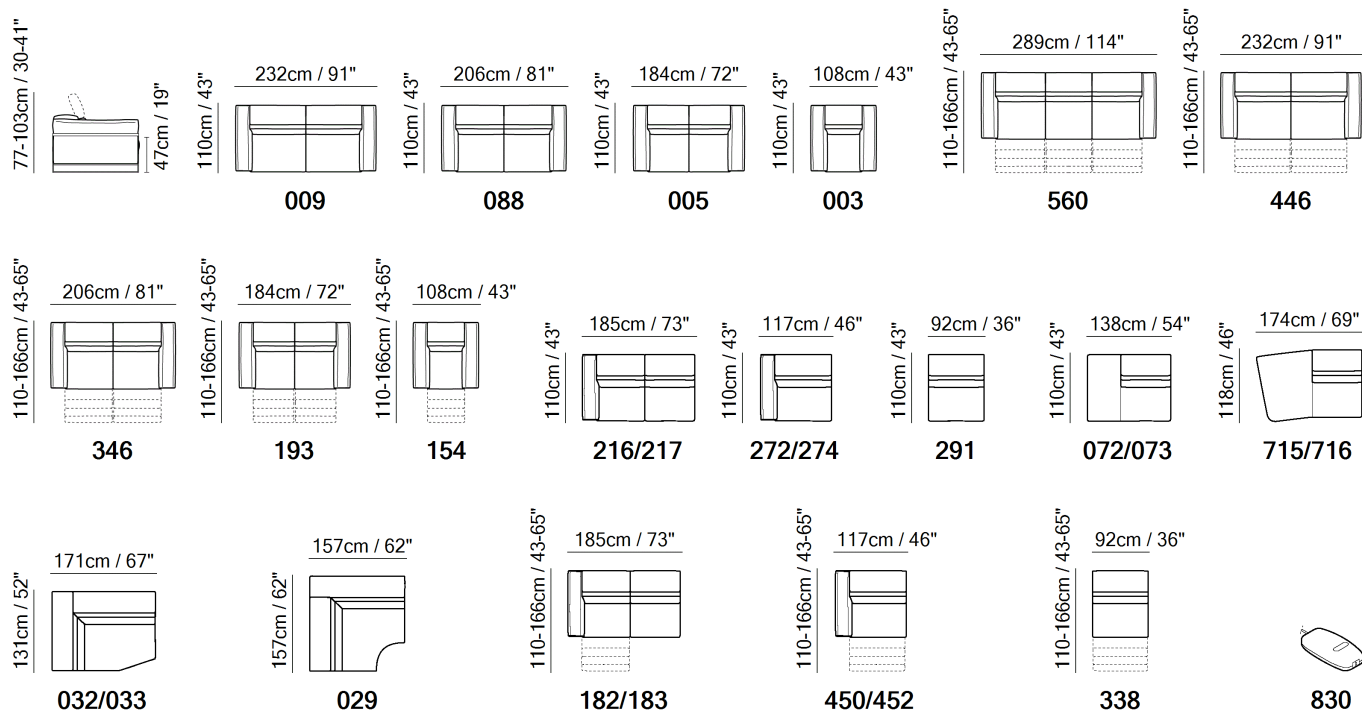

## SCHEMATICS

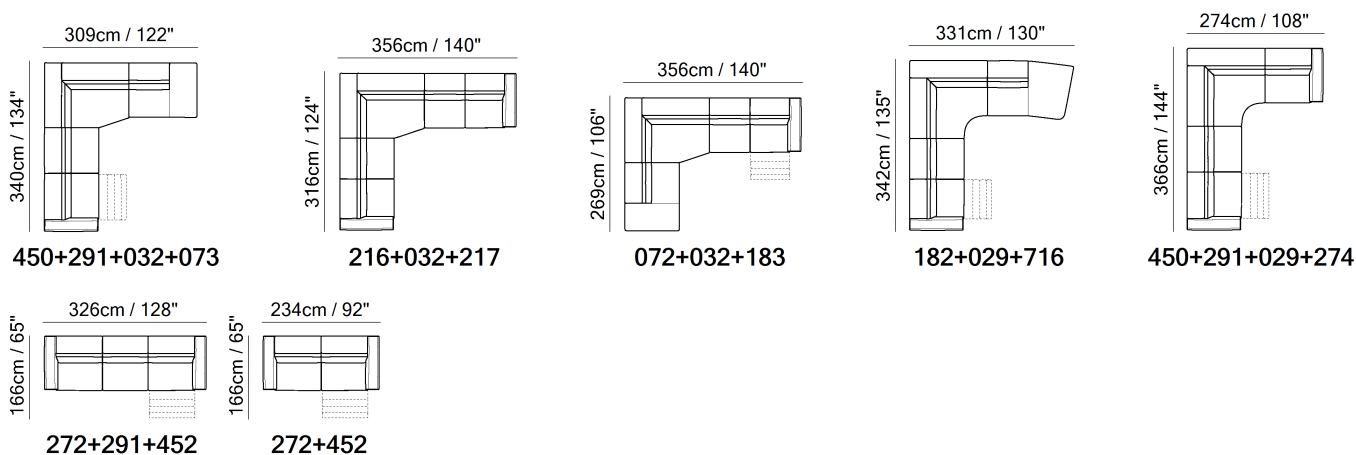

## COMPOSITION EXAMPLES



TECHNICAL INFORMATION

	<b>COVERING</b>	Leather <input checked="" type="checkbox"/>	Soft Cover <input checked="" type="checkbox"/>				
	<b>FILLING</b>	Arms	<input type="checkbox"/> Fiber <input checked="" type="checkbox"/> Foam <input type="checkbox"/> Feather/Fiber Mix <input type="checkbox"/> Feather	Seat cushion	<input type="checkbox"/> Fiber <input checked="" type="checkbox"/> Foam <input type="checkbox"/> Feather/Fiber Mix <input type="checkbox"/> Feather	Back cushion	<input type="checkbox"/> Fiber <input checked="" type="checkbox"/> Foam <input type="checkbox"/> Feather/Fiber Mix <input type="checkbox"/> Feather
	<b>COMFORT</b>	Standard Comfort <input checked="" type="checkbox"/>	Firm Comfort <input checked="" type="checkbox"/>				
	<b>FUNCTION</b>	Bed <input type="checkbox"/>	Electric motion <input checked="" type="checkbox"/>	Motion <input checked="" type="checkbox"/>	Recliner <input checked="" type="checkbox"/>	Sliding <input type="checkbox"/>	
	<b>LEGS</b>	Wood <input type="checkbox"/>	Metal <input checked="" type="checkbox"/>	Plastic <input type="checkbox"/>	Castors <input type="checkbox"/>	Upholstered <input type="checkbox"/>	

NOTES

- Designed by Maurizio Manzoni.
- Date of launch: 2014.
- Fidelio is an innovative sofa, offering extreme comfort.
- Boasting superior structure and optional high-tech relax systems, Fidelio's feature armrests are embellished by "pinched" piping and held in a metal frame which defines the outline of the sofa.
- Available with Soft Touch mechanism that changes the seat and back cushion position with a simple tap.
- Model has power combined headrest. ATTENTION! The headrest opens first followed by the footrest; then the headrest has one final extra rotation for comfortable TV watching position.
- Thanks to ZeroWall mechanism, seat and back cushions can be reclined at a great length without moving sofa away from the wall.
- Adjustable headrest on all versions.
- Stationary versions have manually adjustable headrests.
- Version 560, a three seater sofa where each seat has its own electric mechanism.
- A battery pack can be ordered with its own version code 830. For order entry please use XX for category and XXX for cover code. In order to optimize the duration of the battery, it is suggested to order one per each motion seat.
- Model also available with thick leather with model code Sxxx (Art. Cassidy cat.60, Misterbianco cat.30).
- Seat cushion includes a layer of memory foam, a pressure-sensitive soft polyurethane, that recovers its form completely thus giving great comfort.
- Seat and back cushions are fixed to the frame.

**NOTES**

---

- With Feet Assembled (the model will be loaded with feet already mounted on the sofa).
- Internal wooden frame.
- Feet available in metal finishings 74 (Graphite Grey Rough) / 75 (Glazed Nickel) / 78 (Black Chrome)
- Feet height 11,0 cm



■ Vers. 272+274



■ Vers. 272+274



■ Vers. 100+291+291+274



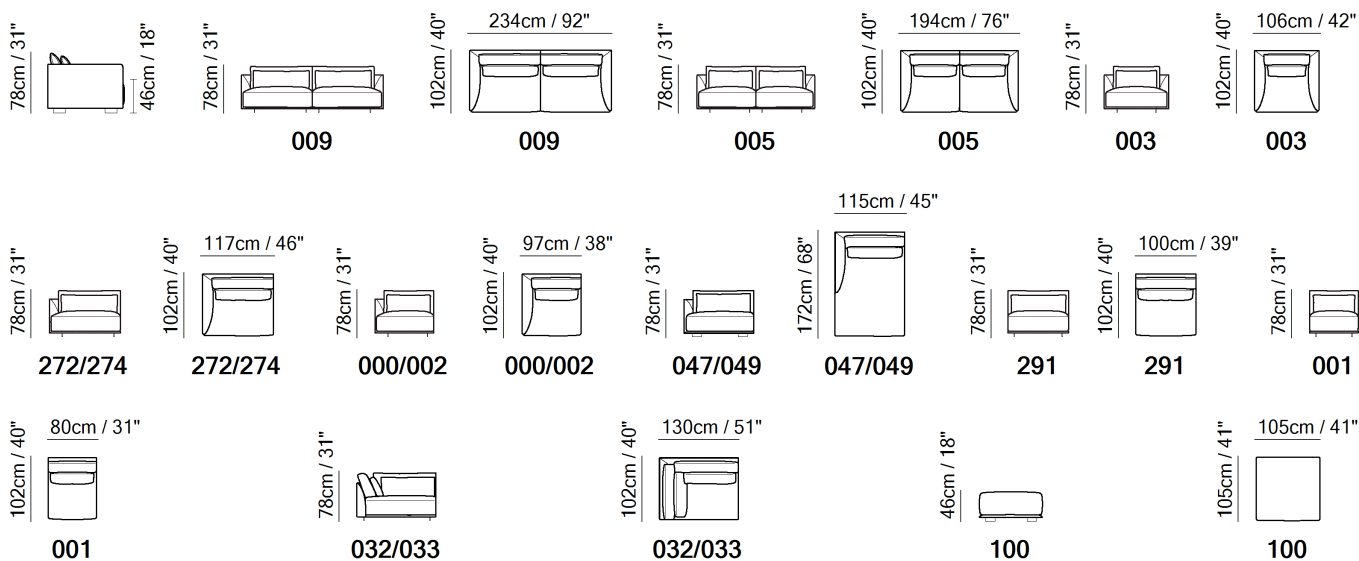

SCHEMATICS

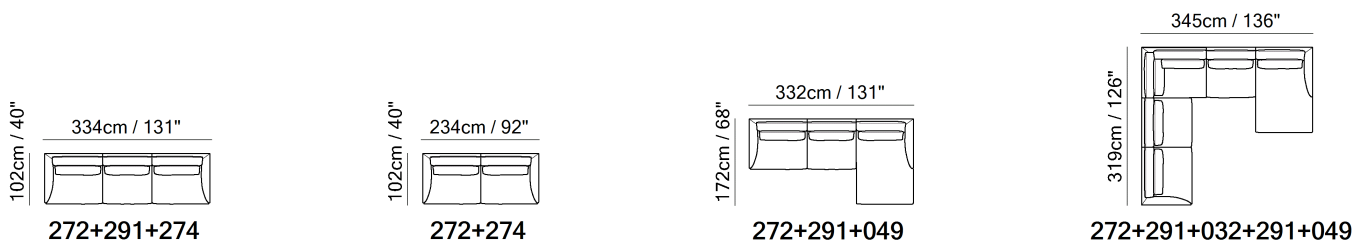

COMPOSITION EXAMPLES



**TECHNICAL INFORMATION**

	<b>COVERING</b>	Leather <input checked="" type="checkbox"/>					
	<b>FILLING</b>	Arms	<input type="checkbox"/> Fiber <input checked="" type="checkbox"/> Foam <input type="checkbox"/> Feather/Fiber Mix <input type="checkbox"/> Feather	Seat cushion	<input type="checkbox"/> Fiber <input checked="" type="checkbox"/> Foam <input type="checkbox"/> Feather/Fiber Mix <input checked="" type="checkbox"/> Feather	Back cushion	<input type="checkbox"/> Fiber <input type="checkbox"/> Foam <input type="checkbox"/> Feather/Fiber Mix <input checked="" type="checkbox"/> Feather
	<b>COMFORT</b>	Standard Comfort <input checked="" type="checkbox"/>	Firm Comfort <input type="checkbox"/>				
	<b>FUNCTION</b>	Bed <input type="checkbox"/>	Electric motion <input type="checkbox"/>	Motion <input type="checkbox"/>	Recliner <input type="checkbox"/>	Sliding <input type="checkbox"/>	
	<b>LEGS</b>	Wood <input type="checkbox"/>	Plastic <input type="checkbox"/>	Metal <input checked="" type="checkbox"/>	Upholstered <input type="checkbox"/>	Castors <input type="checkbox"/>	

**NOTES**

- Long Beach sofa, designed by renowned Italian architect, Claudio Bellini.
- This soft, welcoming design features height-adjustable feet, to suit your personal style.
- The thin armrests leave plenty of room for enjoying the wide, comfortable seats.
- Model is not available with article Misterbianco (cat. 30).
- Seat cushion includes a layer of memory foam, a pressure-sensitive soft polyurethane, that recovers its form completely thus giving great comfort.
- Loose Seat Cushion (the seat cushions of the model are not fixed to the frame)
- Loose Back Cushion (the back cushions of the model are not fixed to the frame)
- With Leather Side (the sectional pieces come with leather sides)
- Internal wooden frame.
- With Feet Assembled (the model will be loaded with feet already mounted on the sofa).
- It is possible to change feet height (see user's instructions)
- Feet available in metal
- Feet height 6,0 / 9,0 cm
-

NOTES

---



■ Vers. 450+338+452



■ Vers. 072+489+338+452



■ Vers. 450+452



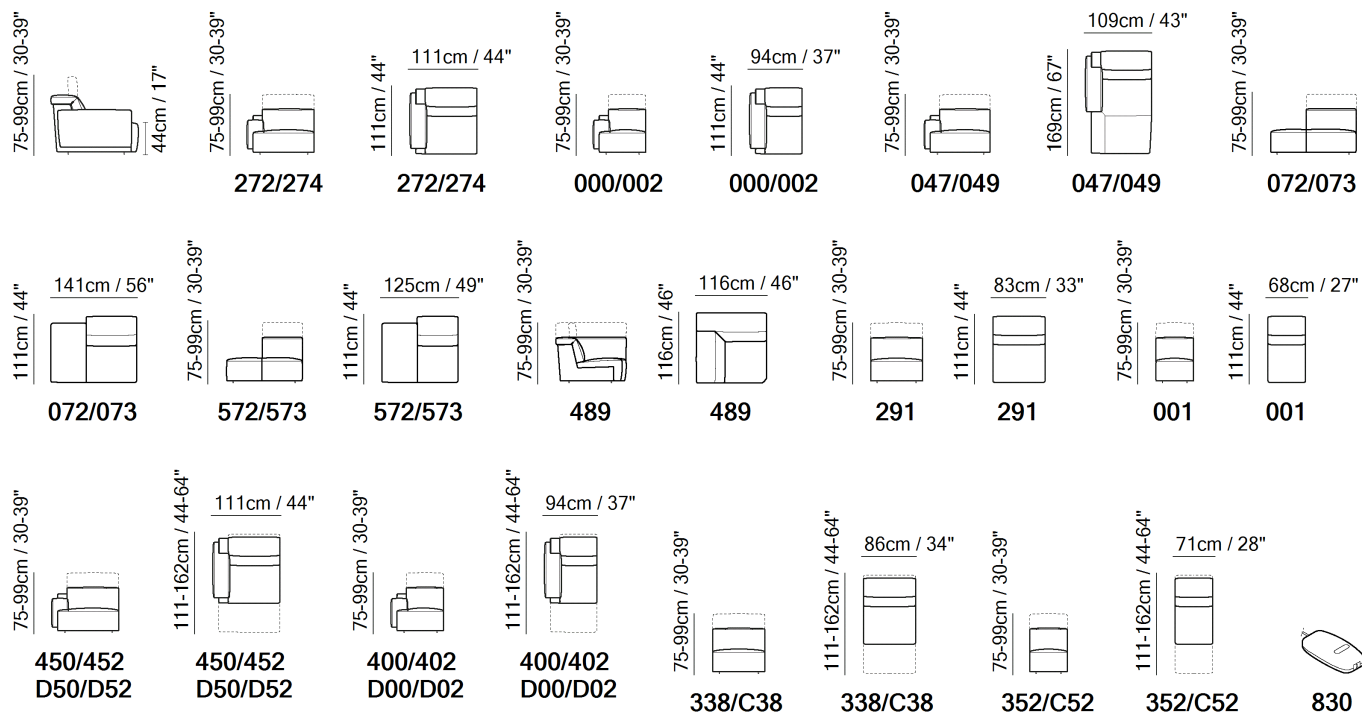

**SCHEMATICS**

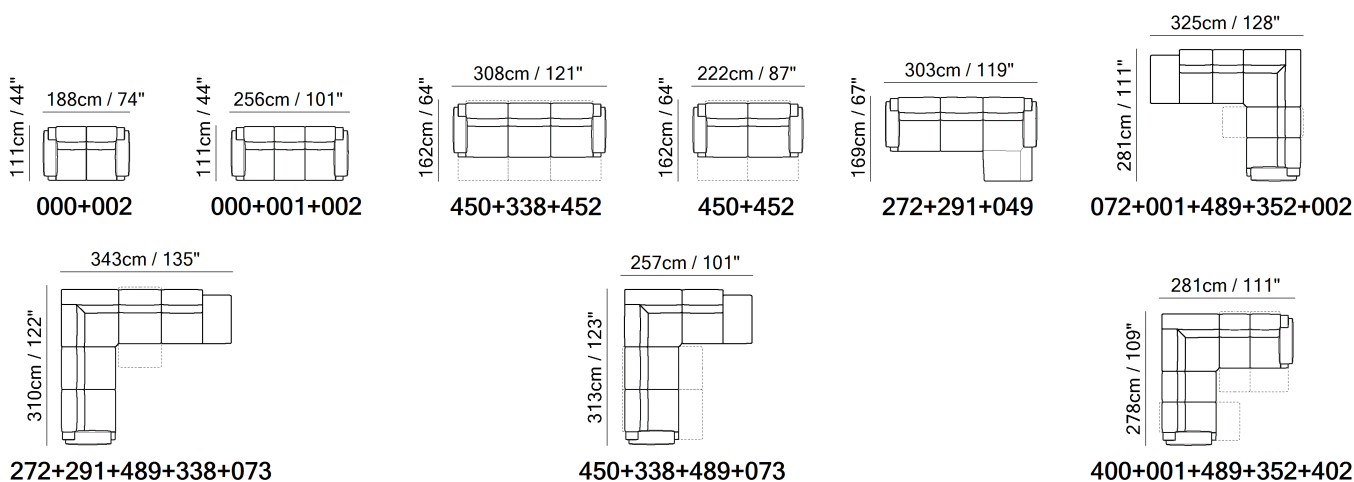

**COMPOSITION EXAMPLES**



TECHNICAL INFORMATION

	<b>COVERING</b>	Leather <input checked="" type="checkbox"/>	Soft Cover <input checked="" type="checkbox"/>				
	<b>FILLING</b>	Arms	<input type="checkbox"/> Fiber <input checked="" type="checkbox"/> Foam <input type="checkbox"/> Feather/Fiber Mix <input type="checkbox"/> Feather	Seat cushion	<input type="checkbox"/> Fiber <input checked="" type="checkbox"/> Foam <input type="checkbox"/> Feather/Fiber Mix <input type="checkbox"/> Feather	Back cushion	<input type="checkbox"/> Fiber <input checked="" type="checkbox"/> Foam <input type="checkbox"/> Feather/Fiber Mix <input type="checkbox"/> Feather
	<b>COMFORT</b>	Standard Comfort <input checked="" type="checkbox"/>	Firm Comfort <input checked="" type="checkbox"/>				
	<b>FUNCTION</b>	Bed <input type="checkbox"/>	Electric motion <input checked="" type="checkbox"/>	Motion <input checked="" type="checkbox"/>	Recliner <input type="checkbox"/>	Sliding <input type="checkbox"/>	
	<b>LEGS</b>	Wood <input type="checkbox"/>	Metal <input type="checkbox"/>	Plastic <input checked="" type="checkbox"/>	Castors <input type="checkbox"/>	Upholstered <input type="checkbox"/>	

NOTES

- Designed by Marek Bujanowski.
- Date of launch: 2015.
- The square and linear shapes of lago combine in perfect harmony with the softness of the padding and give it a pleasantly surprising appearance. The particularly low seating offers comfort and aesthetic appeal. Beauty meets innovation in this sofa: in fact the recline system ensures maximum comfort with the adjustable footrest and headrest, adaptable to your individual needs.
- Seat cushion includes a layer of memory foam, a pressure-sensitive soft polyurethane, that recovers its form completely thus giving great comfort.
- Available with Soft Touch mechanism that changes the seat and back cushion position with a simple tap.
- Model has power combined headrest. ATTENTION! The headrest opens first followed by the footrest; then the headrest has one final extra rotation for comfortable TV watching position.
- Thanks to ZeroWall mechanism, seat and back cushions can be reclined at a great length without moving sofa away from the wall.
- Stationary versions have manually adjustable headrests.
- Second option version corner 489 has both headrests adjustable.
- Seat and back cushions are fixed to the frame.
- A battery pack can be ordered with its own version code 830. For order entry please use XX for category and XXX for cover code. In order to optimize the duration of the battery, it is suggested to order one per each motion seat.
- No Leather/Fabric Side (the sectional pieces have the side covered with lining and not leather nor fabric)
- Internal wooden frame.

## NOTES

---

- Feet will be in a bag inside the package and requires assembling.
- Feet height 5,0 cm



■ Vers. 009



■ Vers. 272+C38+489+291+552



■ Vers. 368



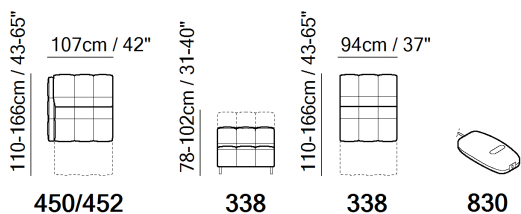
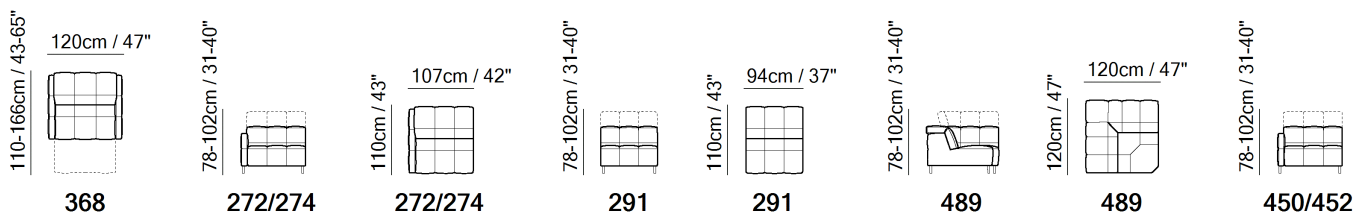
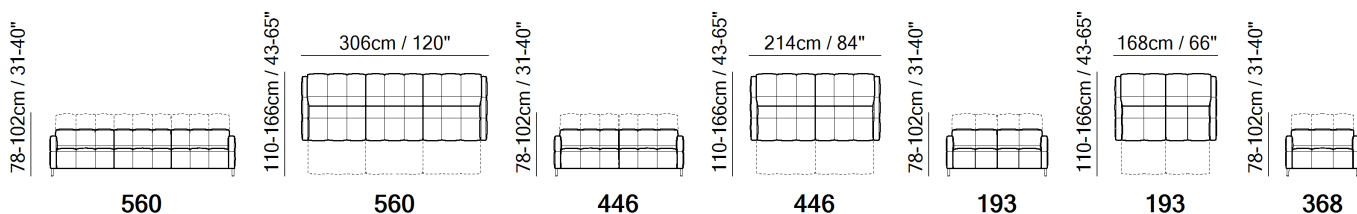
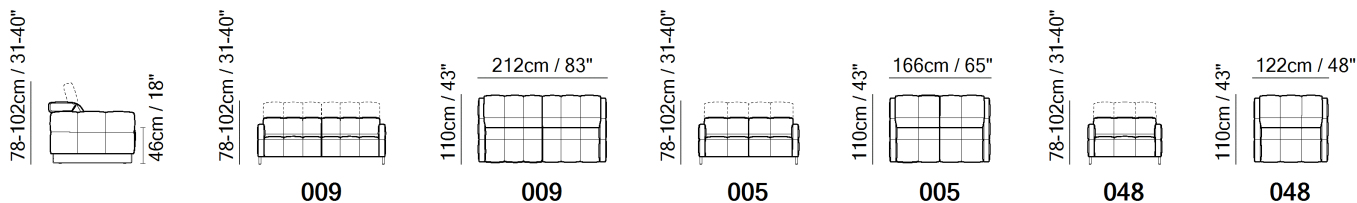

## SCHEMATICS

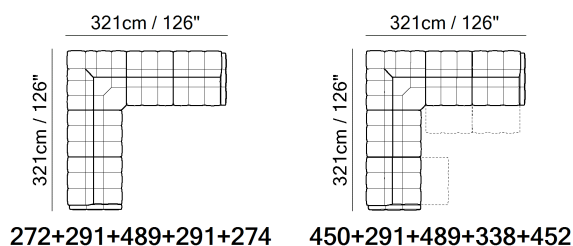

## COMPOSITION EXAMPLES



TECHNICAL INFORMATION

	<b>COVERING</b>	Leather <input checked="" type="checkbox"/>	Soft Cover <input checked="" type="checkbox"/>				
	<b>FILLING</b>	Arms	<input type="checkbox"/> Fiber <input checked="" type="checkbox"/> Foam <input type="checkbox"/> Feather/Fiber Mix <input type="checkbox"/> Feather	Seat cushion	<input type="checkbox"/> Fiber <input checked="" type="checkbox"/> Foam <input type="checkbox"/> Feather/Fiber Mix <input type="checkbox"/> Feather	Back cushion	<input type="checkbox"/> Fiber <input checked="" type="checkbox"/> Foam <input type="checkbox"/> Feather/Fiber Mix <input type="checkbox"/> Feather
	<b>COMFORT</b>	Standard Comfort <input checked="" type="checkbox"/>	Firm Comfort <input type="checkbox"/>				
	<b>FUNCTION</b>	Bed <input type="checkbox"/>	Electric motion <input checked="" type="checkbox"/>	Motion <input checked="" type="checkbox"/>	Recliner <input checked="" type="checkbox"/>	Sliding <input type="checkbox"/>	
	<b>LEGS</b>	Wood <input type="checkbox"/>	Plastic <input type="checkbox"/>	Metal <input checked="" type="checkbox"/>	Upholstered <input type="checkbox"/>	Castors <input type="checkbox"/>	

NOTES

- Designed by Marek Bujanowski.
- Date of launch: 2015.
- Philo is a sofa with a unique style, with its refined quilting and specially-shaped metal feet that give it a modern and elegant aspect. The clear and precise shape of the armrests and backrest pair perfectly with the softness of the padding, offering a peerless comfort and a stunning visual impact. Philo naturally becomes the true focal point of any space in which it is placed.
- Model is not available with article Misterbianco (cat. 30).
- Available with Soft Touch mechanism that changes the seat and back cushion position with a simple tap.
- Model has power combined headrest. ATTENTION! The headrest opens first followed by the footrest; then the headrest has one final extra rotation for comfortable TV watching position.
- Stationary versions have manually adjustable headrests.
- Thanks to ZeroWall mechanism, seat and back cushions can be reclined at a great length without moving sofa away from the wall.
- Version 560, a three seater sofa where each seat has its own electric mechanism.
- A battery pack can be ordered with its own version code 830. For order entry please use XX for category and XXX for cover code. In order to optimize the duration of the battery, it is suggested to order one per each motion seat.
- Seat and back cushions are fixed to the frame.
- Internal wooden frame.
- Feet available in metal finishings 74 (Graphite gray rough) / 77 (Glossy chrome) / 78 (Black chrome)
- Feet will be in a bag inside the package and requires assembling.

## NOTES

---

- Feet height 13,0 cm



■ Vers. 088



■ Vers. 560



■ Vers. 482+481



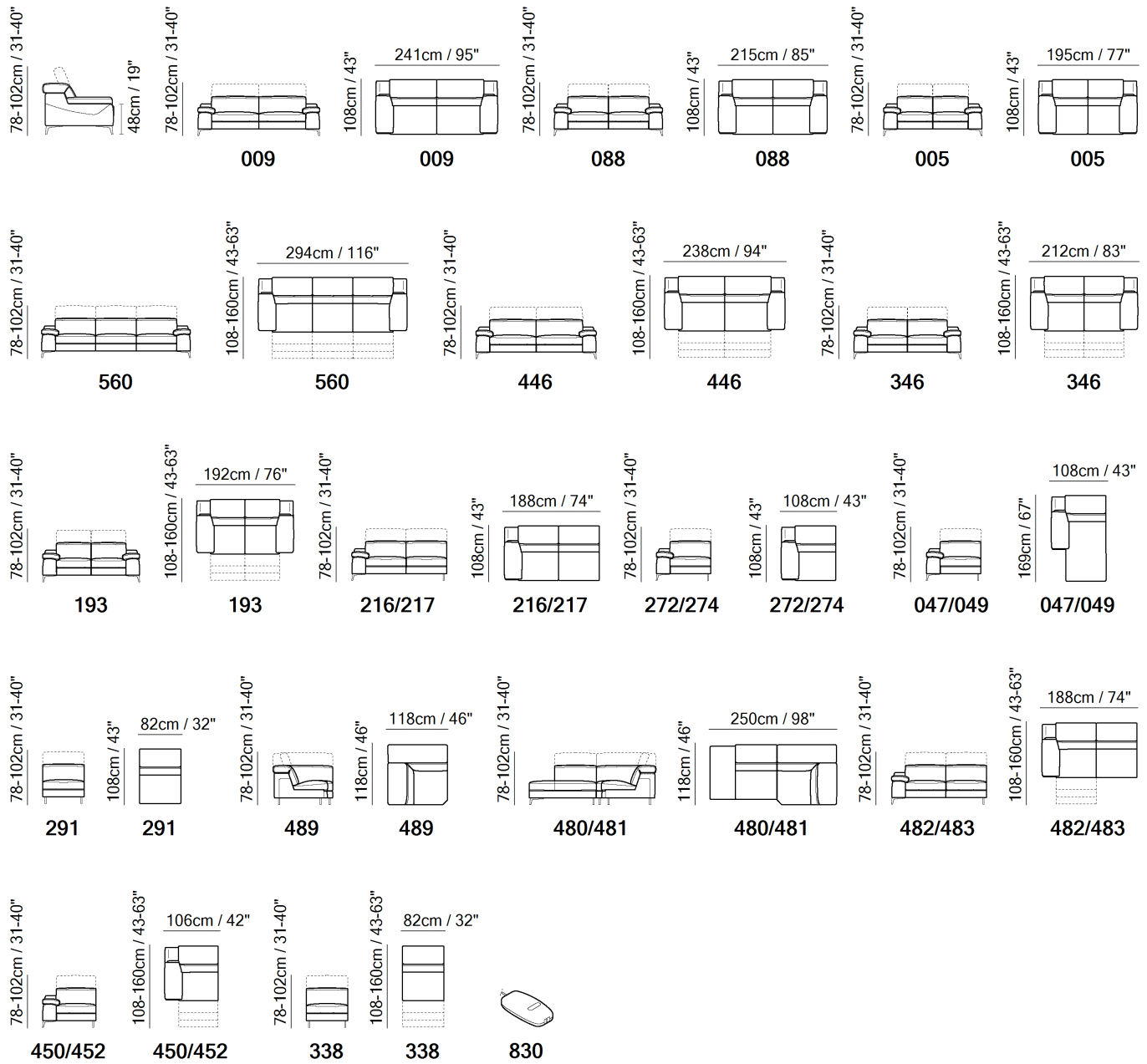

**SCHEMATICS**

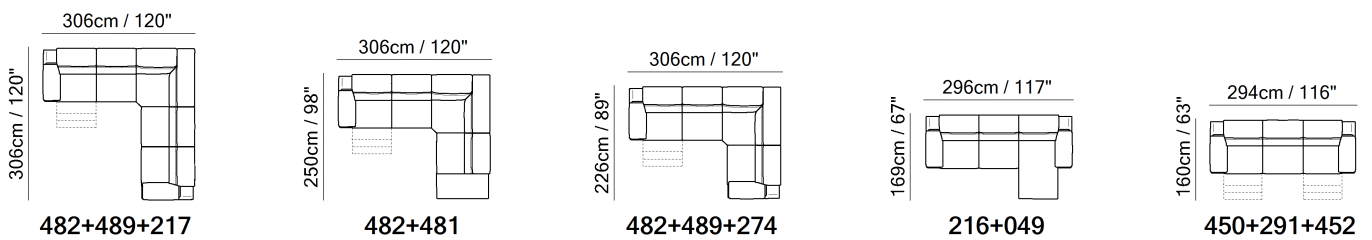

**COMPOSITION EXAMPLES**



TECHNICAL INFORMATION

	<b>COVERING</b>	Leather <input checked="" type="checkbox"/>	Soft Cover <input checked="" type="checkbox"/>			
	<b>FILLING</b>	Arms <input type="checkbox"/> Fiber <input checked="" type="checkbox"/> Foam <input type="checkbox"/> Feather/Fiber Mix <input type="checkbox"/> Feather	Seat cushion <input type="checkbox"/> Fiber <input checked="" type="checkbox"/> Foam <input type="checkbox"/> Feather/Fiber Mix <input type="checkbox"/> Feather	Back cushion <input type="checkbox"/> Fiber <input checked="" type="checkbox"/> Foam <input type="checkbox"/> Feather/Fiber Mix <input type="checkbox"/> Feather		
	<b>COMFORT</b>	Standard Comfort <input checked="" type="checkbox"/>	Firm Comfort <input checked="" type="checkbox"/>			
	<b>FUNCTION</b>	Bed <input type="checkbox"/>	Electric motion <input checked="" type="checkbox"/>	Motion <input checked="" type="checkbox"/>	Recliner <input type="checkbox"/>	Sliding <input type="checkbox"/>
	<b>LEGS</b>	Wood <input type="checkbox"/>	Metal <input checked="" type="checkbox"/>	Plastic <input type="checkbox"/>	Castors <input type="checkbox"/>	Upholstered <input type="checkbox"/>

NOTES

- Designed by Natuzzi Design Center.
- Date of launch: 2015.
- An imposing and perfectly crafted sofa. Duca gives an impression of comfort right from the first glance. Perfect combination of technology and relax by Natuzzi Italia.
- The wide armrests and seats and adjustable headrest make it extremely comfortable.
- The sofa is meticulously crafted and extremely attractive from any angle, making it the perfect centrepiece for a room.
- Available with Soft Touch mechanism that changes the seat and back cushion position with a simple tap.
- Model has power combined headrest. ATTENTION! The headrest opens first followed by the footrest; then the headrest has one final extra rotation for comfortable TV watching position.
- Stationary versions have manually adjustable headrests.
- Thanks to ZeroWall mechanism, seat and back cushions can be reclined at a great length without moving sofa away from the wall.
- Seat cushion includes a layer of memory foam, a pressure-sensitive soft polyurethane, that recovers its form completely thus giving great comfort.
- A battery pack can be ordered with its own version code 830. For order entry please use XX for category and XXX for cover code. In order to optimize the duration of the battery, it is suggested to order one per each motion seat.
- Seat and back cushions are fixed to the frame.
- Internal wooden frame.
- Feet will be in a bag inside the package and requires assembling.

## NOTES

---

- Feet available in metal finishings 74 (Graphite Grey Rough) / 77 (Glossy Chromed) / 78 (Black Chrome)
- Feet height 13,0 cm



■ Vers. 272+291+429+073



■ Vers. 272+291+429+073+047



■ Vers.



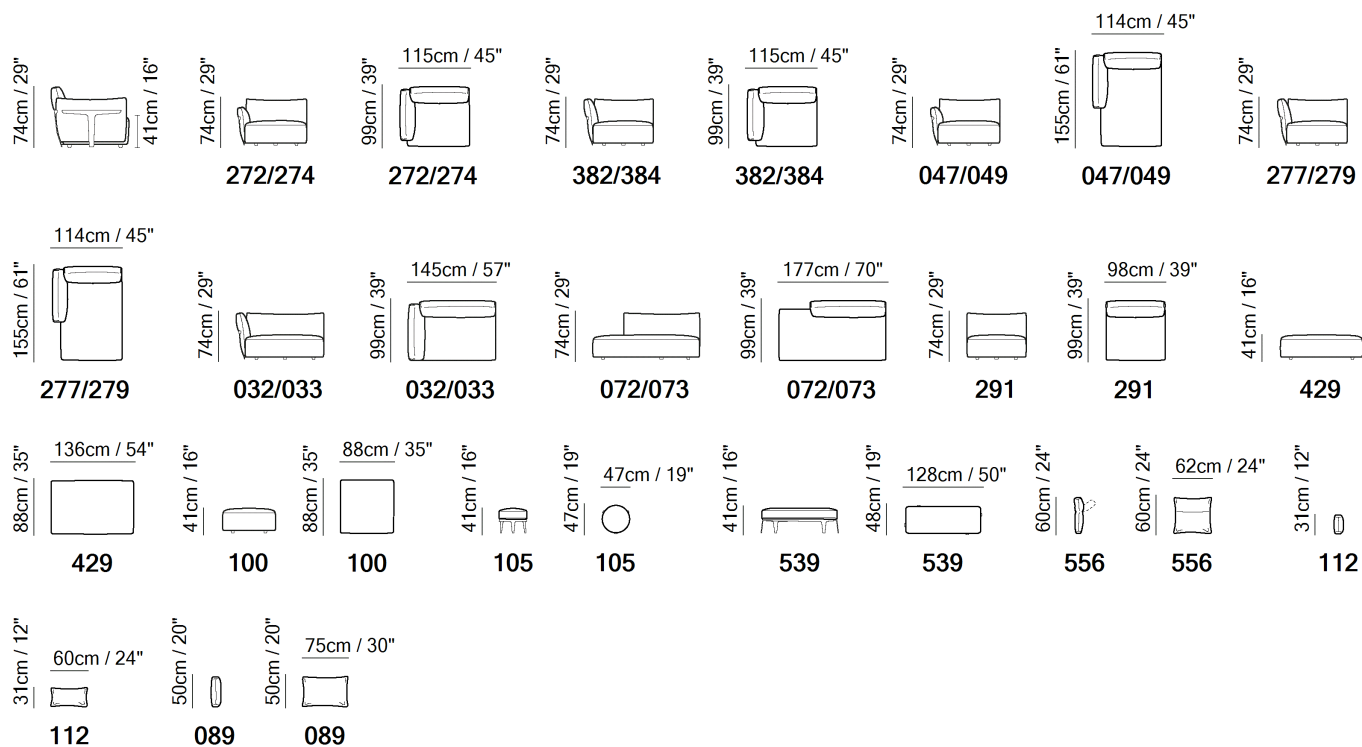

## SCHEMATICS

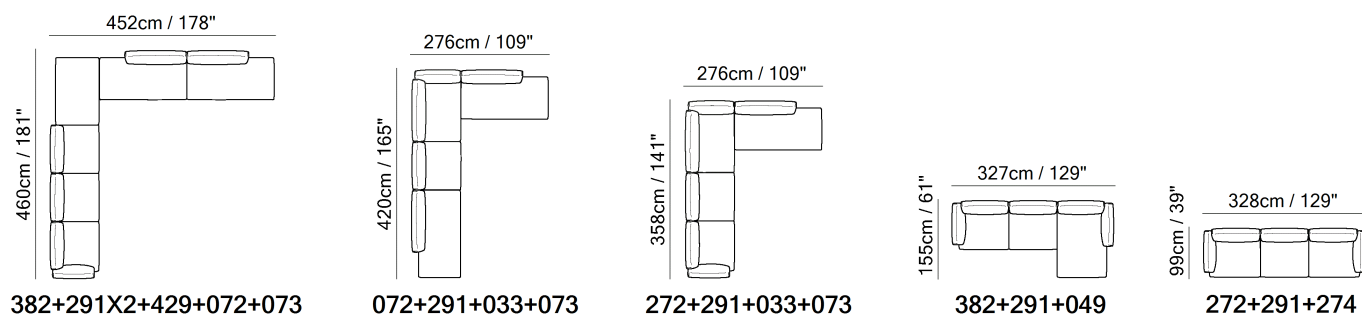

## COMPOSITION EXAMPLES



TECHNICAL INFORMATION

	<b>COVERING</b>	Soft Cover <input checked="" type="checkbox"/>					
	<b>FILLING</b>	Arms	<input type="checkbox"/> Fiber <input checked="" type="checkbox"/> Foam <input type="checkbox"/> Feather/Fiber Mix <input checked="" type="checkbox"/> Feather	Seat cushion	<input type="checkbox"/> Fiber <input checked="" type="checkbox"/> Foam <input type="checkbox"/> Feather/Fiber Mix <input checked="" type="checkbox"/> Feather	Back cushion	<input type="checkbox"/> Fiber <input checked="" type="checkbox"/> Foam <input type="checkbox"/> Feather/Fiber Mix <input checked="" type="checkbox"/> Feather
	<b>COMFORT</b>	Standard Comfort <input checked="" type="checkbox"/>	Firm Comfort <input type="checkbox"/>				
	<b>FUNCTION</b>	Bed <input type="checkbox"/>	Electric motion <input type="checkbox"/>	Motion <input type="checkbox"/>	Recliner <input type="checkbox"/>	Sliding <input type="checkbox"/>	
	<b>LEGS</b>	Wood <input type="checkbox"/>	Plastic <input checked="" type="checkbox"/>	Metal <input type="checkbox"/>	Upholstered <input type="checkbox"/>	Castors <input type="checkbox"/>	

NOTES

- The Herman sofa, designed by architects Manzoni and Tapinassi, features deep, comfortable seats equipped with chaise-longue end units that allow you to comfortably lie down.
- The backrests are decorated with matching cushions, while the armrests emphasize the essential design of the sofa, enhanced by the presence of extremely elegant stitching.
- The backrests are decorated with matching cushions, while the armrests emphasize the essential design of the sofa, enhanced by the presence of extremely elegant stitching.
- To allow modularity, the single elements can be put together thanks to the rubber stops under the legs.
- Model not available in Portavenezia fabric.
- Seat cushion includes a layer of memory foam, a pressure-sensitive soft polyurethane, that recovers its form completely thus giving great comfort.
- Model Herman (2981) can be ordered in leather using code V981. In leather aesthetics of the sofa are completely different.
- Model is available with welt in Gros-Grain (2,5 cm) to be entered as second covering (code 10800005xx)
- Attention! Gros-grain (2° riv) is not available on versions 100-105-539-556
- Second option versions (chaise longue 277/279 and seat with one arm 382/384) have a higher arm height aligned with backcushions.
- Tight Seat Cushion (the seat cushions of the models are fixed to the frame)
- Loose Back Cushion (the back cushions of the model are not fixed to the frame)
- With Fabric Side (the sectional pieces come with fabric sides)
- Internal wooden frame.

## NOTES

---

- With Feet Assembled (the model will be loaded with feet already mounted on the sofa).
- Metal spine available in metal finishings 80 (pewter) and 81 (glazed bronze)
- Feet height 4,5 cm



■ Vers. A54



■ Vers. A54





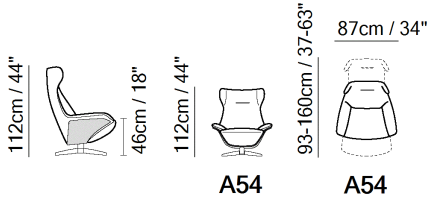

■ Vers. A54

SCHEMATICS

---



TECHNICAL INFORMATION

	<b>COVERING</b>	Leather <input checked="" type="checkbox"/>	Soft Cover <input checked="" type="checkbox"/>				
	<b>FILLING</b>	Arms	<input type="checkbox"/> Fiber <input checked="" type="checkbox"/> Foam <input type="checkbox"/> Feather/Fiber Mix <input type="checkbox"/> Feather	Seat cushion	<input type="checkbox"/> Fiber <input checked="" type="checkbox"/> Foam <input type="checkbox"/> Feather/Fiber Mix <input type="checkbox"/> Feather	Back cushion	<input type="checkbox"/> Fiber <input checked="" type="checkbox"/> Foam <input type="checkbox"/> Feather/Fiber Mix <input type="checkbox"/> Feather
	<b>COMFORT</b>	Standard Comfort <input checked="" type="checkbox"/>	Firm Comfort <input type="checkbox"/>				
	<b>FUNCTION</b>	Bed <input type="checkbox"/>	Electric motion <input type="checkbox"/>	Motion <input type="checkbox"/>	Recliner <input type="checkbox"/>	Sliding <input type="checkbox"/>	
	<b>LEGS</b>	Wood <input type="checkbox"/>	Metal <input checked="" type="checkbox"/>	Plastic <input type="checkbox"/>	Castors <input type="checkbox"/>	Upholstered <input type="checkbox"/>	

NOTES

- Designed by Mauro Lipparini.
- Date of launch: 2016.
- Available in leather or fabric.
- In leather the model is available starting from cat. 15 (Le Mans).
- Model not available in Misterbianco and Cassidy leathers.
- Model is available with welt in Gros-Grain (3 cm) to be entered as second covering (code 10800004xx)
- Model with integrated rechargeable battery.
- Tight Seat Cushion (the seat cushions of the models are fixed to the frame)
- Tight Back Cushion (the back cushions of the models are fixed to the frame)
- Metal Frame
- With Feet Assembled (the model will be loaded with feet already mounted on the sofa).
- Wooden side panel in finishings 32 (Smoked Oak) / 34 (Aged Walnut) / 35 (Radica Frisé)
- Metal base available in finishing 80 (pewter)

NOTES

---



■ Vers. 064



■ Vers. 212+220+019



■ Vers. 047+019



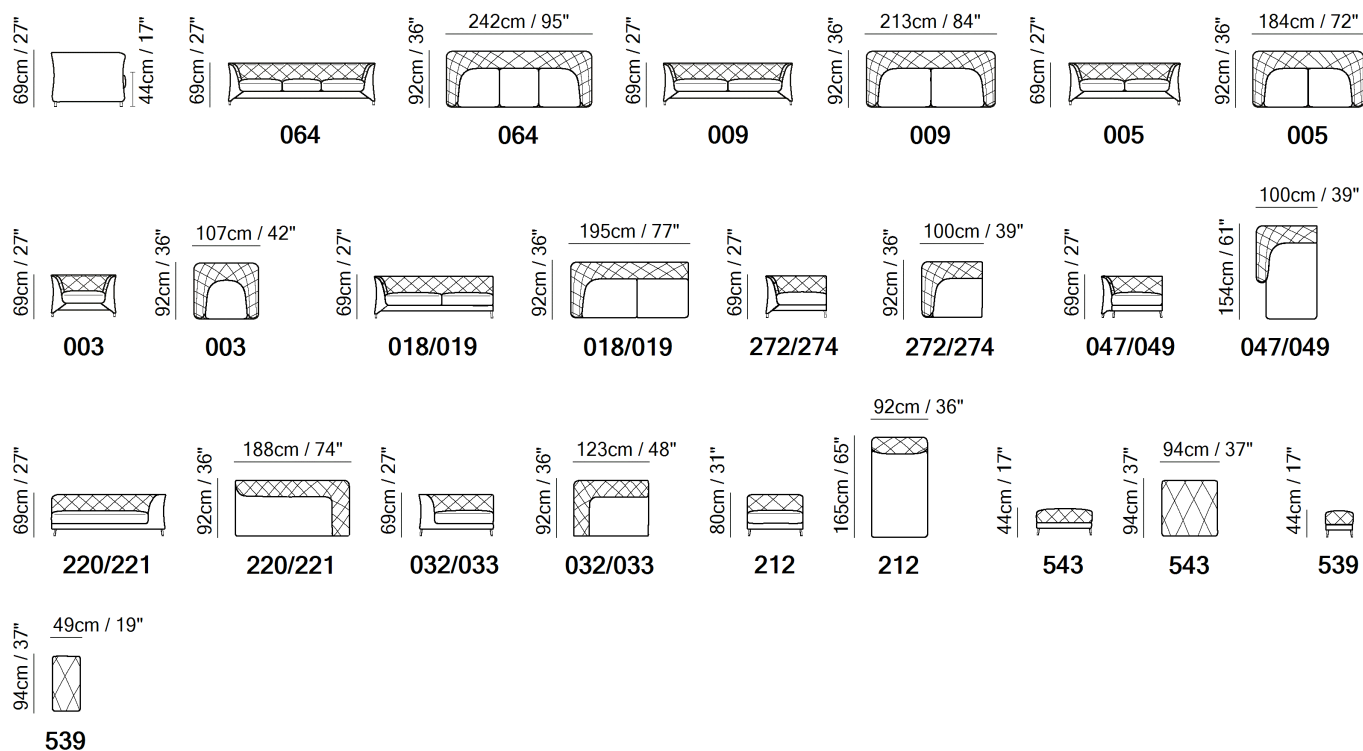

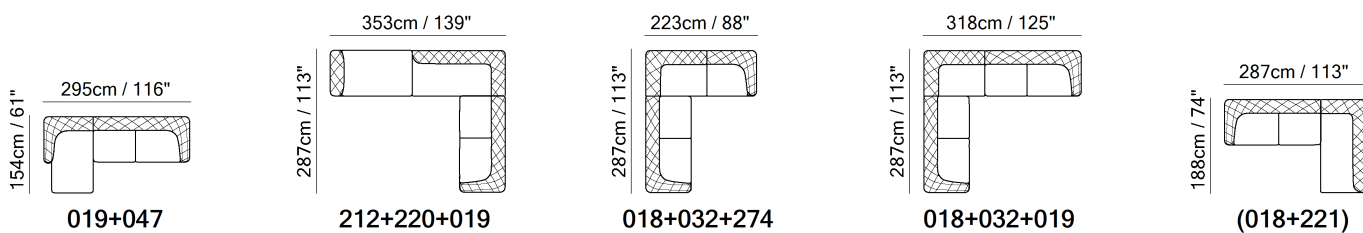

## SCHEMATICS



## COMPOSITION EXAMPLES



TECHNICAL INFORMATION

	<b>COVERING</b>	Leather <input checked="" type="checkbox"/>	Soft Cover <input checked="" type="checkbox"/>			
	<b>FILLING</b>	Arms <input type="checkbox"/> Fiber <input checked="" type="checkbox"/> Foam <input type="checkbox"/> Feather/Fiber Mix <input type="checkbox"/> Feather	Seat cushion <input type="checkbox"/> Fiber <input checked="" type="checkbox"/> Foam <input type="checkbox"/> Feather/Fiber Mix <input type="checkbox"/> Feather	Back cushion <input type="checkbox"/> Fiber <input checked="" type="checkbox"/> Foam <input type="checkbox"/> Feather/Fiber Mix <input type="checkbox"/> Feather		
	<b>COMFORT</b>	Standard Comfort <input checked="" type="checkbox"/>	Firm Comfort <input type="checkbox"/>			
	<b>FUNCTION</b>	Bed <input type="checkbox"/>	Electric motion <input type="checkbox"/>	Motion <input type="checkbox"/>	Recliner <input type="checkbox"/>	Sliding <input type="checkbox"/>
	<b>VISUAL APPEARANCE*</b>	Low <input type="checkbox"/>	Medium <input checked="" type="checkbox"/>	High <input type="checkbox"/>		
	<b>LEGS</b>	Wood <input type="checkbox"/>	Plastic <input type="checkbox"/>	Metal <input checked="" type="checkbox"/>	Upholstered <input type="checkbox"/>	Castors <input type="checkbox"/>

VISUAL APPEARANCE

The product may reveal various wrinkles due to the combination of Elasticity of the covering, characteristics of the interior construction and the design of the product.



Products with Visual Appearance listed as High or Medium would require higher degree of care, where seats and back cushions may require fluffing and plumping more often than Products with Visual Appearance listed as Low.

NOTES

- A modern reinterpretation of a classic chester, the La Scala sofa, designed by Claudio Bellini, is a masterpiece of craftsmanship, characterized by the straight lines along the perimeter that surround the detail of the deep-buttoned upholstery and the softness of the cushions.
- The interplay between interior and exterior gives rise to a sofa with a unique design, which is also incredibly comfortable thanks to the fine padding inserted in the enveloping backrest and deep seat.
- A traditional model that even blends in with contemporary furnishing projects with elegance and sobriety.
- Model is not available with article Misterbianco (cat. 30).
- Seat cushion includes a layer of memory foam, a pressure-sensitive soft polyurethane, that recovers its form completely thus giving great comfort.
- Tight Back Cushion (the back cushions of the models are fixed to the frame)
- Loose Seat Cushion (the seat cushions of the model are not fixed to the frame)
- Feet will be in a bag inside the package and requires assembling.
- Feet available in metal finishing 78 (Black Chrome)
- Feet height 12,5 cm

**NOTES**

---



■ Vers. 009



■ Vers. 088



■ Vers. 088



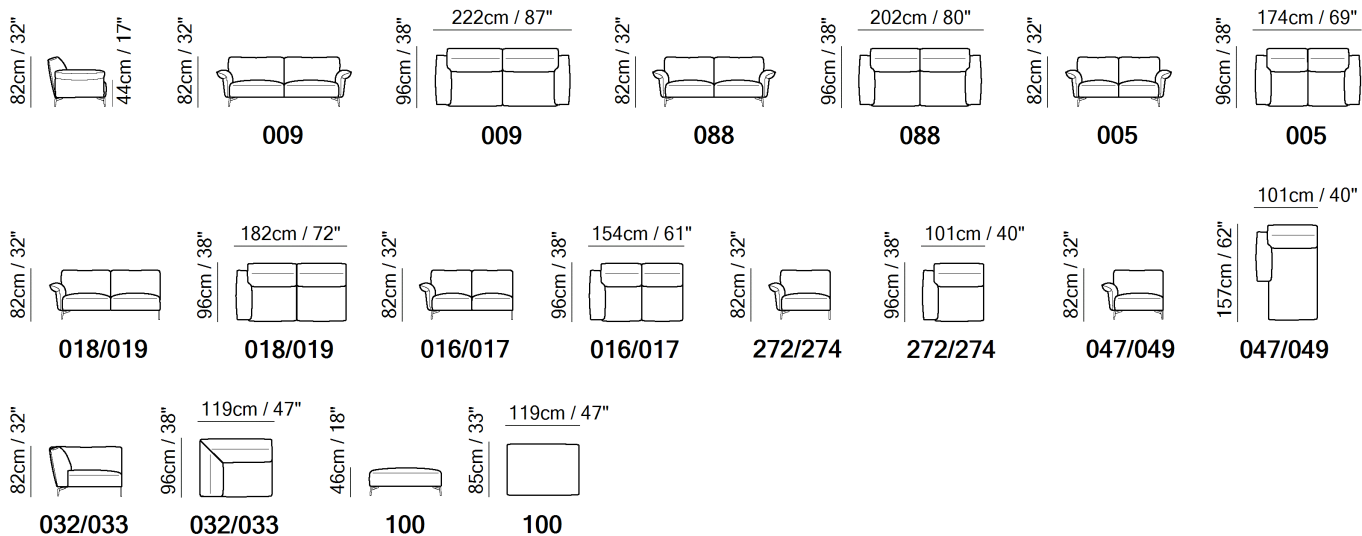

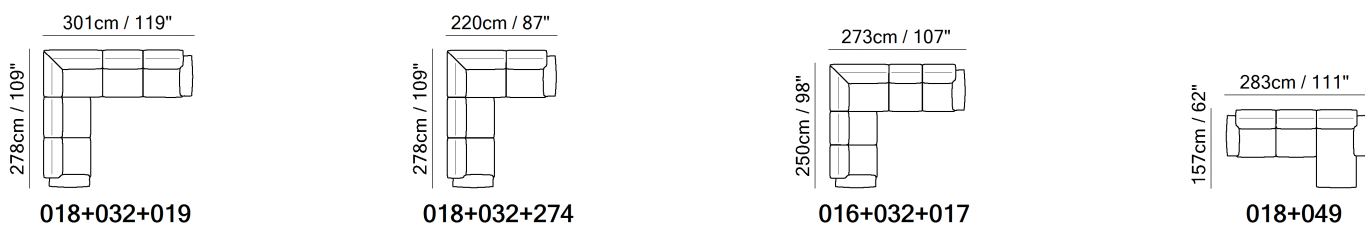

## SCHEMATICS



## COMPOSITION EXAMPLES



TECHNICAL INFORMATION

	<b>COVERING</b>	Leather <input checked="" type="checkbox"/>	Soft Cover <input checked="" type="checkbox"/>			
	<b>FILLING</b>	Arms <input type="checkbox"/> Fiber <input checked="" type="checkbox"/> Foam <input type="checkbox"/> Feather/Fiber Mix <input checked="" type="checkbox"/> Feather	Seat cushion <input type="checkbox"/> Fiber <input checked="" type="checkbox"/> Foam <input type="checkbox"/> Feather/Fiber Mix <input type="checkbox"/> Feather	Back cushion <input type="checkbox"/> Fiber <input checked="" type="checkbox"/> Foam <input type="checkbox"/> Feather/Fiber Mix <input type="checkbox"/> Feather		
	<b>COMFORT</b>	Standard Comfort <input checked="" type="checkbox"/>	Firm Comfort <input type="checkbox"/>			
	<b>FUNCTION</b>	Bed <input type="checkbox"/>	Electric motion <input type="checkbox"/>	Motion <input type="checkbox"/>	Recliner <input type="checkbox"/>	Sliding <input type="checkbox"/>
	<b>VISUAL APPEARANCE*</b>	Low <input type="checkbox"/>	Medium <input checked="" type="checkbox"/>	High <input type="checkbox"/>		
	<b>LEGS</b>	Wood <input type="checkbox"/>	Metal <input checked="" type="checkbox"/>	Plastic <input type="checkbox"/>	Castors <input type="checkbox"/>	Upholstered <input type="checkbox"/>

VISUAL APPEARANCE

The product may reveal various wrinkles due to the combination of Elasticity of the covering, characteristics of the interior construction and the design of the product.



Products with Visual Appearance listed as High or Medium would require higher degree of care, where seats and back cushions may require fluffing and plumping more often than Products with Visual Appearance listed as Low.

NOTES

- Compactness, style and elegance are combined in a vintage-effect sofa that is ideal for urban and metropolitan spaces. The model features highly versatile configurations and coverings.
- In leather the model is available starting from cat. A0.
- Model is not available with article Misterbianco (cat. 30).
- Tight Seat Cushion (the seat cushions of the models are fixed to the frame)
- Tight Back Cushion (the back cushions of the models are fixed to the frame)
- Internal wooden frame.
- Feet will be in a bag inside the package and requires assembling.
- Feet available in metal finishing 78 (Black Chrome)
- Feet height 14,0 cm

NOTES

---



■ Vers. 450+338+452



■ Vers. 450+338+452



■ Vers. 450+452



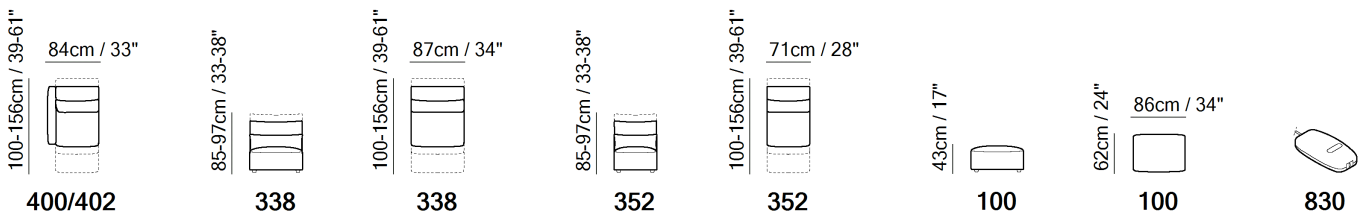
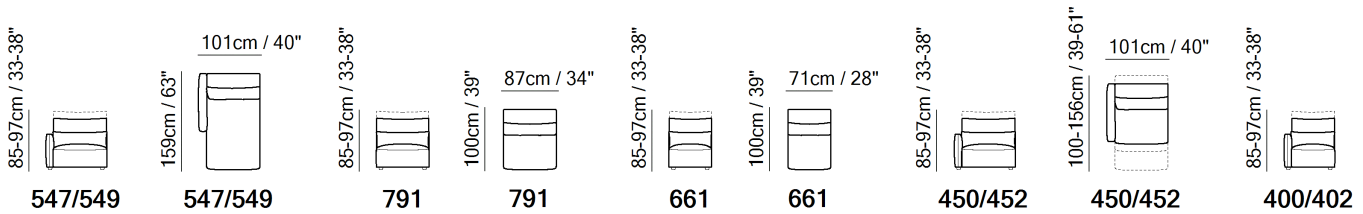
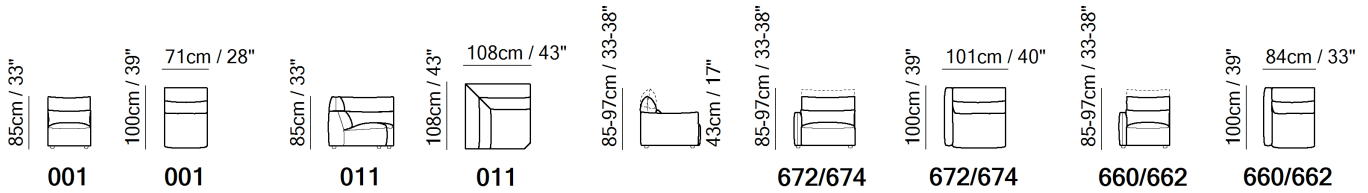
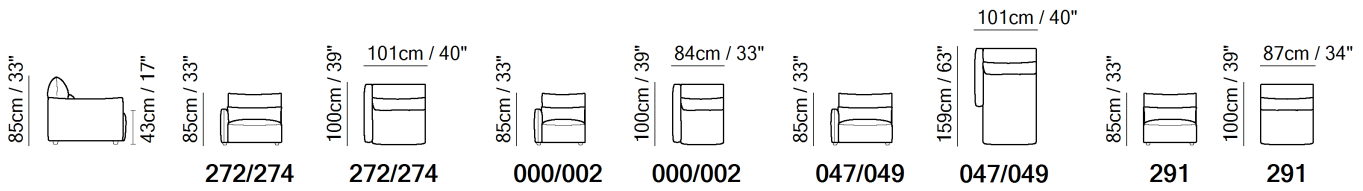

SCHEMATICS

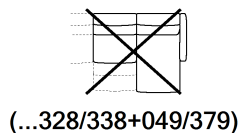
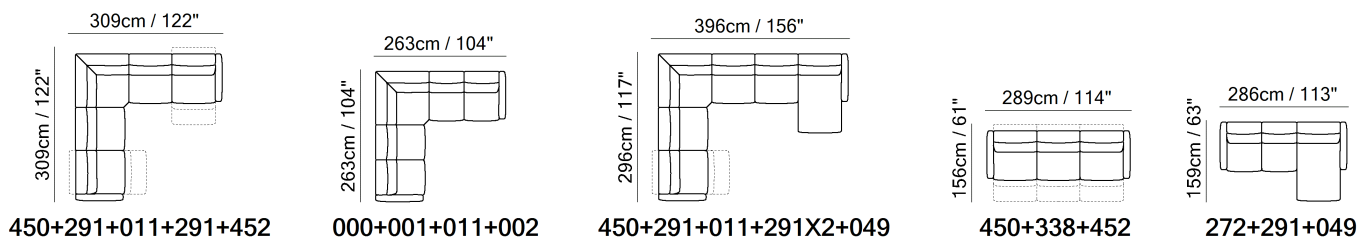

COMPOSITION EXAMPLES



TECHNICAL INFORMATION

	<b>COVERING</b>	Leather <input checked="" type="checkbox"/>			
	<b>FILLING</b>	Arms	Seat cushion	Back cushion	
		<input type="checkbox"/> Fiber	<input type="checkbox"/> Fiber	<input type="checkbox"/> Fiber	
		<input checked="" type="checkbox"/> Foam	<input checked="" type="checkbox"/> Foam	<input checked="" type="checkbox"/> Foam	
		<input type="checkbox"/> Feather/Fiber Mix	<input type="checkbox"/> Feather/Fiber Mix	<input type="checkbox"/> Feather/Fiber Mix	
		<input type="checkbox"/> Feather	<input type="checkbox"/> Feather	<input type="checkbox"/> Feather	
	<b>COMFORT</b>	Standard Comfort <input checked="" type="checkbox"/>	Firm Comfort <input type="checkbox"/>		
	<b>FUNCTION</b>	Bed <input type="checkbox"/>	Electric motion <input checked="" type="checkbox"/>	Motion <input checked="" type="checkbox"/>	Recliner <input type="checkbox"/>
					Sliding <input type="checkbox"/>
	<b>LEGS</b>	Wood <input type="checkbox"/>	Plastic <input checked="" type="checkbox"/>	Metal <input type="checkbox"/>	Upholstered <input type="checkbox"/>
					Castors <input type="checkbox"/>

NOTES

- An authentic galaxy of comfort, design and innovation. An enveloping design is combined with extreme modularity, space-saving features and a latest-generation recliner, allowing you to activate the headrest and footrest on each seat to obtain the desired position.
- Model Galaxy (3029) can be ordered in fabric using code V029. When upholstered in fabric, Galaxy features a precious leather insert on the armrest.
- Model is not available with article Misterbianco (cat. 30).
- To allow modularity, the single elements can be put together thanks to the rubber stops under the legs.
- Dual power mechanism with internal seat buttons (recliner and power headrest lift with manual adjustable tilt position)
- Switch is located internally between arm and seat, that activates recliner and headrest lift separately.
- A battery pack can be ordered with its own version code 830. For order entry please use XX for category and XXX for cover code. In order to optimize the duration of the battery, it is suggested to order one per each motion seat.
- Seat and back cushions are fixed to the frame.
- Internal wooden frame.
- Feet will be in a bag inside the package and requires assembling.
- Feet height 4,0 cm

NOTES

---



■ Vers. 446



■ Vers. 446



■ Vers. 450+338+399+073



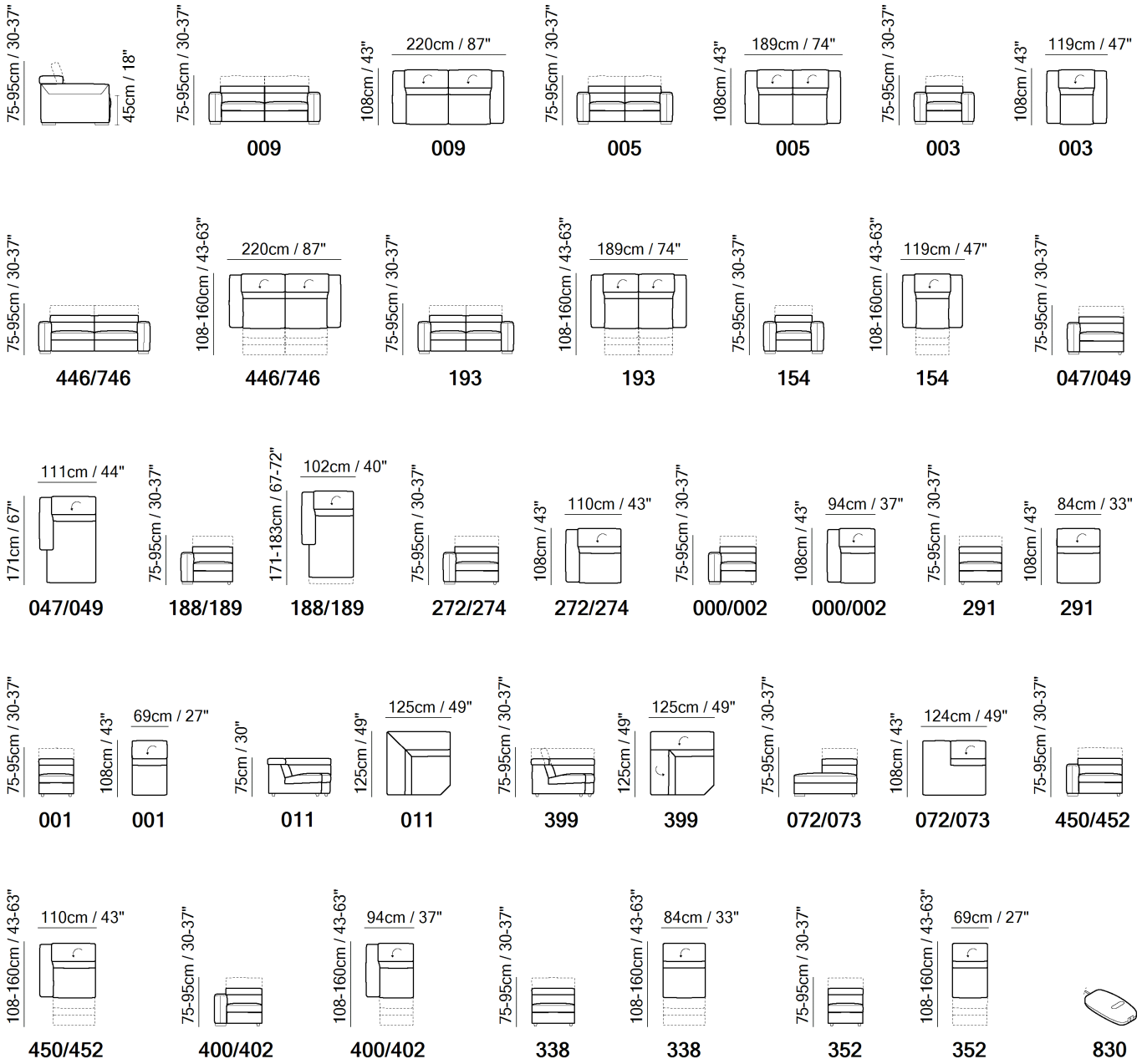

## SCHEMATICS

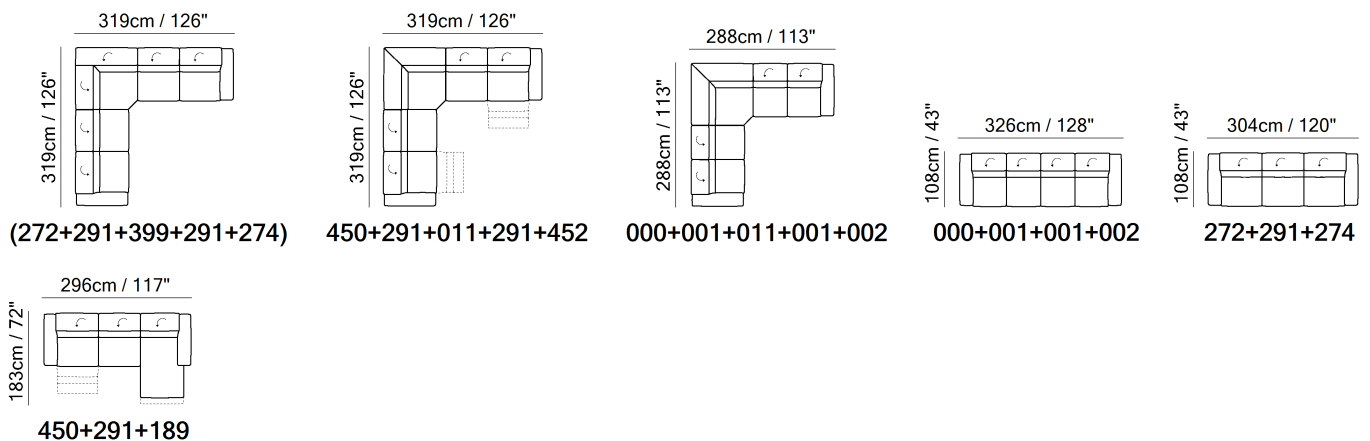

## COMPOSITION EXAMPLES



TECHNICAL INFORMATION

	<b>COVERING</b>	Leather <input checked="" type="checkbox"/>	Soft Cover <input checked="" type="checkbox"/>				
	<b>FILLING</b>	Arms	<input type="checkbox"/> Fiber <input checked="" type="checkbox"/> Foam <input type="checkbox"/> Feather/Fiber Mix <input type="checkbox"/> Feather	Seat cushion	<input type="checkbox"/> Fiber <input checked="" type="checkbox"/> Foam <input type="checkbox"/> Feather/Fiber Mix <input type="checkbox"/> Feather	Back cushion	<input type="checkbox"/> Fiber <input checked="" type="checkbox"/> Foam <input type="checkbox"/> Feather/Fiber Mix <input type="checkbox"/> Feather
	<b>COMFORT</b>	Standard Comfort <input checked="" type="checkbox"/>	Firm Comfort <input checked="" type="checkbox"/>				
	<b>FUNCTION</b>	Bed <input type="checkbox"/>	Electric motion <input checked="" type="checkbox"/>	Motion <input checked="" type="checkbox"/>	Recliner <input checked="" type="checkbox"/>	Sliding <input type="checkbox"/>	
	<b>LEGS</b>	Wood <input checked="" type="checkbox"/>	Metal <input type="checkbox"/>	Plastic <input type="checkbox"/>	Castors <input type="checkbox"/>	Upholstered <input type="checkbox"/>	

NOTES

- Designed by Natuzzi Design Center.
- Date of launch: 2017.
- A sofa that becomes the star of every living room and space. Adjustable headrest on each seat, integrated lumbar support, recliner and space-saving functions: you could ask for no more.
- Model is not available with article Misterbianco (cat. 30).
- LEATHER: Contrast stitching is available only in leather and guided directly in Nares. The colour of the stitching is strictly connected to the colour of the leather chosen.
- FABRIC: In fabric contrast welt (as well as any another decorative detail such as a band under arm cushion or backrest or inserts) can be made with any color of art. Le Mans.
- Available with Soft Touch mechanism that changes the seat and back cushion position with a simple tap.
- Thanks to ZeroWall mechanism, seat and back cushions can be reclined at a great length without moving sofa away from the wall.
- A battery pack can be ordered with its own version code 830. For order entry please use XX for category and XXX for cover code. In order to optimize the duration of the battery, it is suggested to order one per each motion seat.
- Seat and back cushions are fixed to the frame.
- No Leather/Fabric Side (the sectional pieces have the side covered with lining and not leather nor fabric)
- Internal wooden frame.
- Feet available in wood finishings 09 (Walnut) / 18 (Wengè)
- Feet will be in a bag inside the package and requires assembling.

## NOTES

---

- Feet height 4,0 cm



■ Vers. 009



■ Vers. 018+049



■ Vers. 586



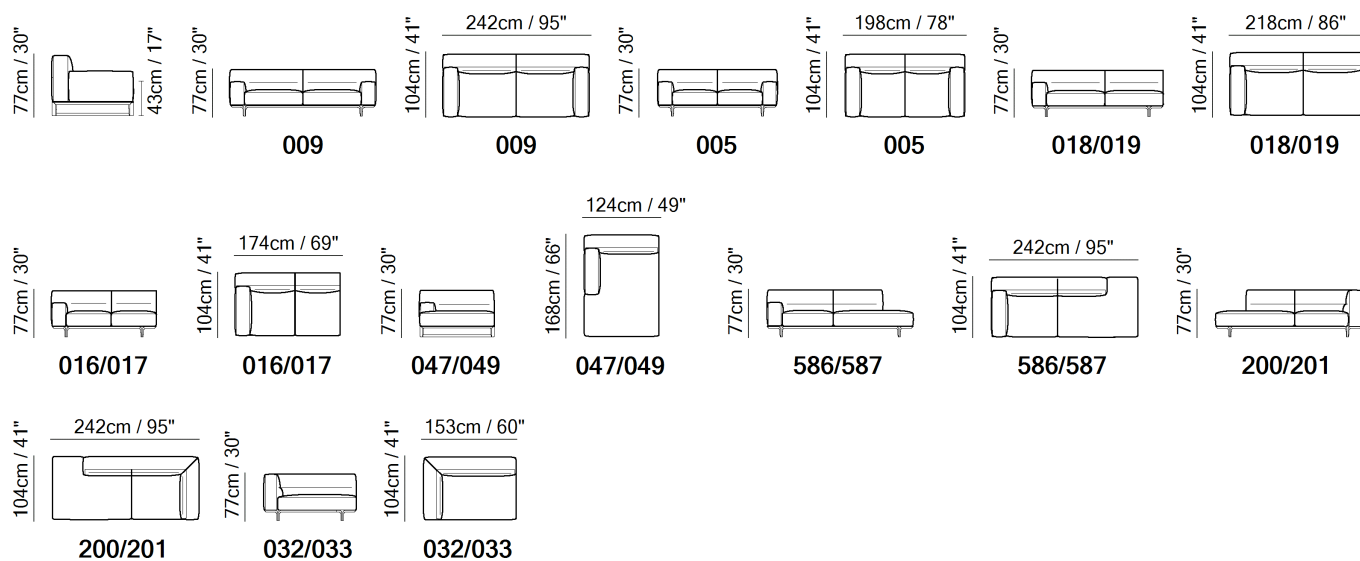

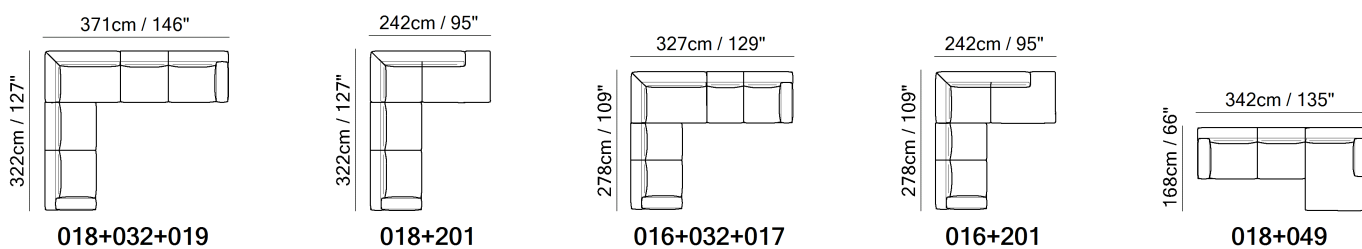

## SCHEMATICS



## COMPOSITION EXAMPLES



TECHNICAL INFORMATION

	<b>COVERING</b>	Leather <input checked="" type="checkbox"/>	Soft Cover <input checked="" type="checkbox"/>			
	<b>FILLING</b>	Arms <input type="checkbox"/> Fiber <input checked="" type="checkbox"/> Foam <input type="checkbox"/> Feather/Fiber Mix <input type="checkbox"/> Feather	Seat cushion <input type="checkbox"/> Fiber <input checked="" type="checkbox"/> Foam <input type="checkbox"/> Feather/Fiber Mix <input type="checkbox"/> Feather	Back cushion <input type="checkbox"/> Fiber <input checked="" type="checkbox"/> Foam <input type="checkbox"/> Feather/Fiber Mix <input type="checkbox"/> Feather		
	<b>COMFORT</b>	Standard Comfort <input checked="" type="checkbox"/>	Firm Comfort <input type="checkbox"/>			
	<b>FUNCTION</b>	Bed <input type="checkbox"/>	Electric motion <input type="checkbox"/>	Motion <input type="checkbox"/>	Recliner <input type="checkbox"/>	Sliding <input type="checkbox"/>
	<b>VISUAL APPEARANCE*</b>	Low <input type="checkbox"/>	Medium <input type="checkbox"/>	High <input checked="" type="checkbox"/>		
	<b>LEGS</b>	Wood <input checked="" type="checkbox"/>	Plastic <input type="checkbox"/>	Metal <input type="checkbox"/>	Upholstered <input type="checkbox"/>	Castors <input type="checkbox"/>

VISUAL APPEARANCE

The product may reveal various wrinkles due to the combination of Elasticity of the covering, characteristics of the interior construction and the design of the product.



Products with Visual Appearance listed as High or Medium would require higher degree of care, where seats and back cushions may require fluffing and plumping more often than Products with Visual Appearance listed as Low.

NOTES

- Designed by Tapinassi & Manzoni.
- Date of launch: 2017.
- A perfect combination of modularity, craftsmanship and refined design. Kendo brings its refined personality to every living area, enhanced by precious details and exceptional comfort.
- Model also available with thick leather with model code Sxxx (Art. Cassidy cat.60, Misterbianco cat.30).
- FABRIC: In fabric contrast welt (as well as any another decorative detail such as a band under arm cushion or backrest or inserts) can be made with any color of art. Le Mans.
- Seat cushion includes a layer of memory foam, a pressure-sensitive soft polyurethane, that recovers its form completely thus giving great comfort.
- Seat and back cushions are fixed to the frame.
- In leather version module side panels are fully upholstered.
- Internal wooden frame.
- Feet available in wooden finishings 32 (Smoked Oak) with metal insert in brass / 33 (Olive Walnut; with upcharge) with metal insert in color pewter
- Feet requires assembling. Feet will be in a separate package.
- Feet height 14,0 cm

NOTES

---



■ Vers. 012



■ Vers. 012





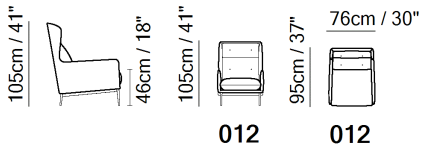

■ Vers. 012

SCHEMATICS

---



**TECHNICAL INFORMATION**

	<b>COVERING</b>	Leather <input checked="" type="checkbox"/>	Soft Cover <input checked="" type="checkbox"/>				
	<b>FILLING</b>	Arms	<input type="checkbox"/> Fiber <input checked="" type="checkbox"/> Foam <input type="checkbox"/> Feather/Fiber Mix <input type="checkbox"/> Feather	Seat cushion	<input type="checkbox"/> Fiber <input checked="" type="checkbox"/> Foam <input type="checkbox"/> Feather/Fiber Mix <input type="checkbox"/> Feather	Back cushion	<input type="checkbox"/> Fiber <input checked="" type="checkbox"/> Foam <input type="checkbox"/> Feather/Fiber Mix <input type="checkbox"/> Feather
	<b>COMFORT</b>	Standard Comfort <input checked="" type="checkbox"/>	Firm Comfort <input type="checkbox"/>				
	<b>FUNCTION</b>	Bed <input type="checkbox"/>	Electric motion <input type="checkbox"/>	Motion <input type="checkbox"/>	Recliner <input type="checkbox"/>	Sliding <input type="checkbox"/>	
	<b>LEGS</b>	Wood <input type="checkbox"/>	Metal <input checked="" type="checkbox"/>	Plastic <input type="checkbox"/>	Castors <input type="checkbox"/>	Upholstered <input type="checkbox"/>	

**NOTES**

- Loose Seat Cushion (the seat cushions of the model are not fixed to the frame)
- Back Cushion Zippered (the back cushion is attached to the frame through a zipper)
- Internal wooden frame.
- Feet will be in a bag inside the package and requires assembling.
- Front feet are slightly higher in respect to rear.
- Feet available in metal finishings 77 (Glossy Chromed) / 78 (Black Chrome)
- Feet height 22,0/14,5 cm

NOTES

---



■ Vers. 009



■ Vers. 446



■ Vers. 272+291+049



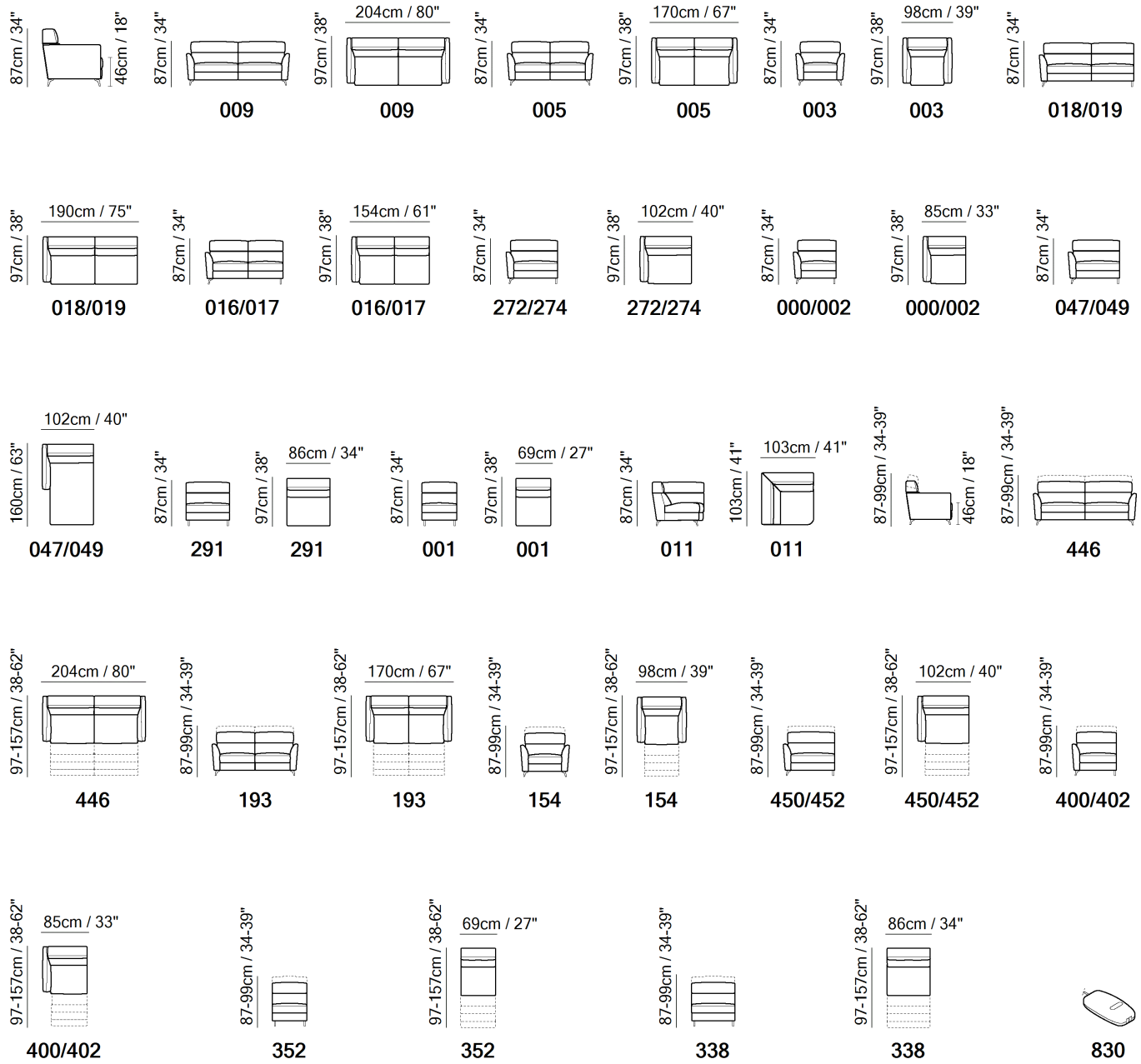

SCHEMATICS

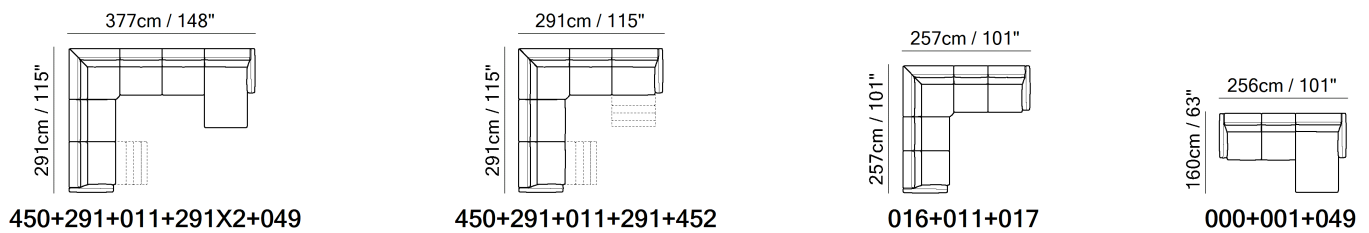

COMPOSITION EXAMPLES



TECHNICAL INFORMATION

	<b>COVERING</b>	Leather <input checked="" type="checkbox"/>	Soft Cover <input checked="" type="checkbox"/>				
	<b>FILLING</b>	Arms	<input type="checkbox"/> Fiber <input checked="" type="checkbox"/> Foam <input type="checkbox"/> Feather/Fiber Mix <input type="checkbox"/> Feather	Seat cushion	<input type="checkbox"/> Fiber <input checked="" type="checkbox"/> Foam <input type="checkbox"/> Feather/Fiber Mix <input type="checkbox"/> Feather	Back cushion	<input type="checkbox"/> Fiber <input checked="" type="checkbox"/> Foam <input type="checkbox"/> Feather/Fiber Mix <input type="checkbox"/> Feather
	<b>COMFORT</b>	Standard Comfort <input checked="" type="checkbox"/>	Firm Comfort <input type="checkbox"/>				
	<b>FUNCTION</b>	Bed <input type="checkbox"/>	Electric motion <input checked="" type="checkbox"/>	Motion <input checked="" type="checkbox"/>	Recliner <input checked="" type="checkbox"/>	Sliding <input type="checkbox"/>	
	<b>LEGS</b>	Wood <input type="checkbox"/>	Plastic <input type="checkbox"/>	Metal <input checked="" type="checkbox"/>	Upholstered <input type="checkbox"/>	Castors <input type="checkbox"/>	

NOTES

- Designed by Enrique Marti.
- Date of launch: 2017.
- A simple, versatile sofa designed by Enrique Marti, ideal for any space and furnishing style. Thanks to the Dual Power mechanism, the headrest and footrest can be operated separately for an unprecedented relaxation.
- Model is not available with article Misterbianco (cat. 30).
- FABRIC: In fabric contrast welt (as well as any another decorative detail such as a band under arm cushion or backrest or inserts) can be made with any color of art. Le Mans.
- Dual power mechanism with internal seat buttons (recliner and power headrest lift with manual adjustable tilt position)
- Switch is located internally between arm and seat, that activates recliner and headrest lift separately.
- Thanks to ZeroWall mechanism, seat and back cushions can be reclined at a great length without moving sofa away from the wall.
- A battery pack can be ordered with its own version code 830. For order entry please use XX for category and XXX for cover code. In order to optimize the duration of the battery, it is suggested to order one per each motion seat.
- Seat and back cushions are fixed to the frame.
- Internal wooden frame.
- Feet available in metal finishings 77 (Glossy Chromed) / 78 (Black Chrome)
- Feet will be in a bag inside the package and requires assembling.
- Feet height 11,0 cm

NOTES

---



■ Vers. 212+017+556+110+108+122



■ Vers. 800+801+330+642+122+122+242+543





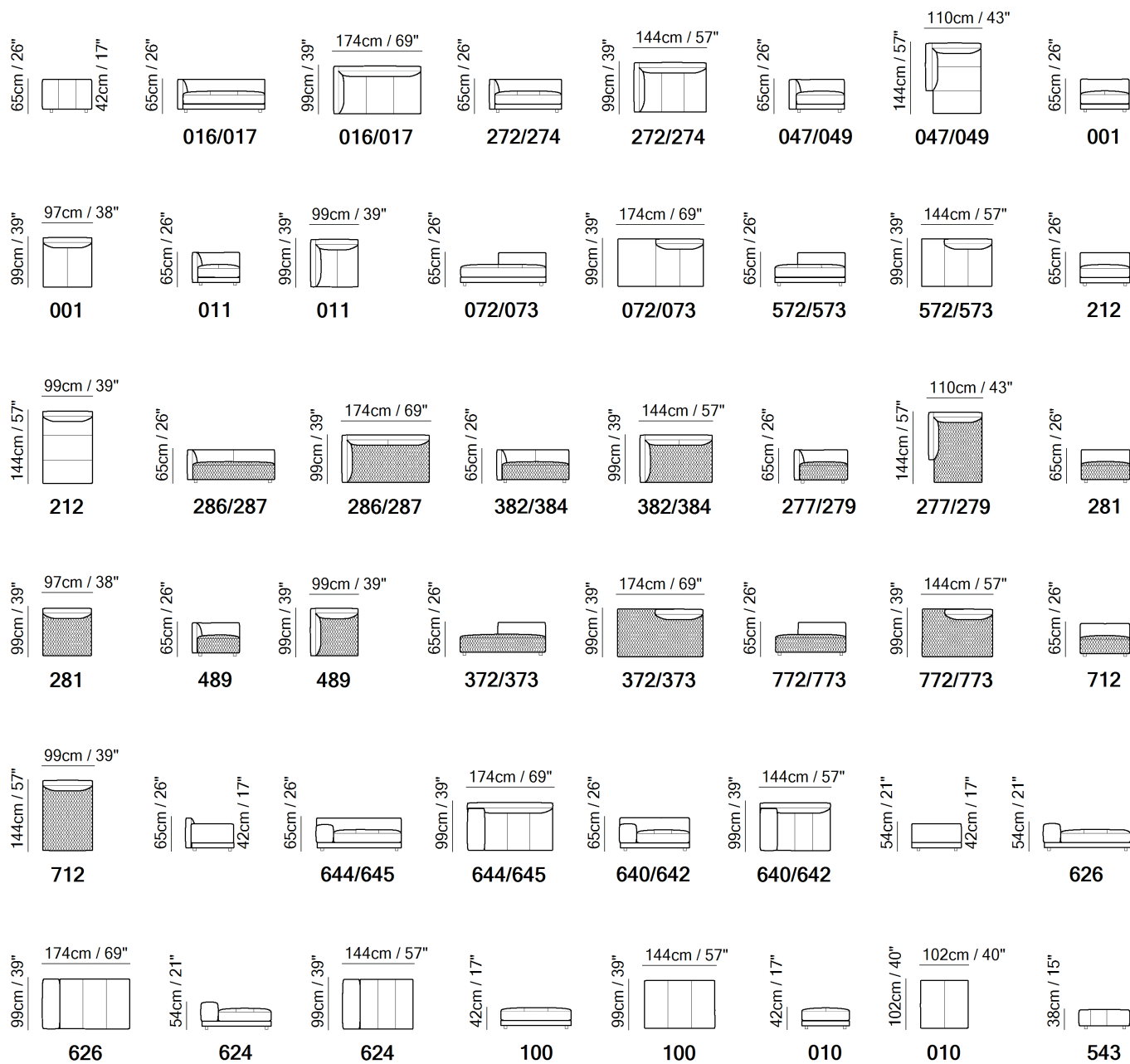

■ Vers. 272+212+001+821+642+811+108+110+110+122+108+108+110+122

SCHEMATICS



## TECHNICAL INFORMATION

	<b>COVERING</b>	Leather <input checked="" type="checkbox"/>	Soft Cover <input checked="" type="checkbox"/>				
	<b>FILLING</b>	Arms	<input type="checkbox"/> Fiber <input checked="" type="checkbox"/> Foam <input type="checkbox"/> Feather/Fiber Mix <input type="checkbox"/> Feather	Seat cushion	<input type="checkbox"/> Fiber <input checked="" type="checkbox"/> Foam <input type="checkbox"/> Feather/Fiber Mix <input type="checkbox"/> Feather	Back cushion	<input type="checkbox"/> Fiber <input checked="" type="checkbox"/> Foam <input type="checkbox"/> Feather/Fiber Mix <input type="checkbox"/> Feather
	<b>COMFORT</b>	Standard Comfort <input checked="" type="checkbox"/>	Firm Comfort <input type="checkbox"/>				
	<b>FUNCTION</b>	Bed <input type="checkbox"/>	Electric motion <input type="checkbox"/>	Motion <input type="checkbox"/>	Recliner <input type="checkbox"/>	Sliding <input type="checkbox"/>	
	<b>LEGS</b>	Wood <input type="checkbox"/>	Metal <input type="checkbox"/>	Plastic <input checked="" type="checkbox"/>	Castors <input type="checkbox"/>	Upholstered <input type="checkbox"/>	

## NOTES

- The Melpot seating collection gets its name from the very mix of features that set it apart. Strictly following architectural design standards, Melpot delivers a plethora of unexpectedly dramatic design options.
- Completely modular: mix it up with hard and soft surfaces such as pouf accent tables, wall panels or shelves to be placed against the padded backrest, or add a freestanding open shelving or drawer unit in wood for a flexible and personalized space. Modular components and accessories give free reign to creative configurations that suit every taste.
- To allow modularity, the single elements can be put together thanks to the rubber stops under the legs.
- To increase the functionality of MELPOT sofa, we have launched also a furnishing system composed of pouf, bench and shelving units.
- Modules have sets of shelf units in three different sizes that can be combined to each side. All shelves are available in three different dimensions to match the three different dimensions of the seats and shelves are available in two different typologies: closed back with a panel or open shelf.
- Second options versions have quilted seat cushions and include an adjustable headrest to obtain the ideal comfort.
- Squared scatter pillow (version 122) is always available in leather/fabric mix.
- Back cushions are always loose and need to be ordered separately with the following version codes: 110-108-122-556
- Version 556 is an adjustable cushion thanks to an internal mechanism that lets the consumer to modify the position in the desired relax position and comfort.
- Model is not available with article Misterbianco (cat. 30).
- Comfort >> The seat cushions are padded with Climalight (special latest-generation silicone microfibre). The loose cushions are filled with goose down for maximum softness.

NOTES

---

- Seat cushion zippered (the seat cushion is attached to the frame through a zipper)
- Frame of the sofa is completely upholstered
- Internal wooden frame.
- Feet will be in a bag inside the package and requires assembling.
- Feet height 6,0 cm
- ORDERING SHELVING UNITS:
  - 1) As alias code enter LIB
  - 2) Choose shelf finishing:
    - - 810 / 811 / 812 / 821 always walnut (ST39)
    - - 800 / 801 / 802 choose between walnut (ST39), blu royal (ST16) or glossy wine (ST22); metal parts are always in finishing black chrome
    - - 820 / 242 external always in walnut (ST39) and for inside to choose from blu royal (ST16), or glossy wine (ST22)



■ Vers. 003



■ Vers. 003



■ Vers. 066

## SCHEMATICS

---



**003**

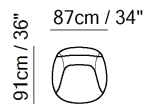

**003**



**066**





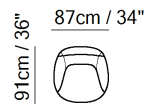

**066**



**066**

TECHNICAL INFORMATION

	<b>COVERING</b>	Mix <input checked="" type="checkbox"/>	Leather <input checked="" type="checkbox"/>	Soft Cover <input checked="" type="checkbox"/>		
	<b>FILLING</b>	Arms <input type="checkbox"/> Fiber <input checked="" type="checkbox"/> Foam <input type="checkbox"/> Feather/Fiber Mix <input type="checkbox"/> Feather	Seat cushion <input type="checkbox"/> Fiber <input checked="" type="checkbox"/> Foam <input type="checkbox"/> Feather/Fiber Mix <input type="checkbox"/> Feather	Back cushion <input type="checkbox"/> Fiber <input checked="" type="checkbox"/> Foam <input type="checkbox"/> Feather/Fiber Mix <input type="checkbox"/> Feather		
	<b>COMFORT</b>	Standard Comfort <input checked="" type="checkbox"/>	Firm Comfort <input type="checkbox"/>			
	<b>FUNCTION</b>	Bed <input type="checkbox"/>	Electric motion <input type="checkbox"/>	Motion <input type="checkbox"/>	Recliner <input type="checkbox"/>	Sliding <input type="checkbox"/>
	<b>LEGS</b>	Wood <input checked="" type="checkbox"/>	Plastic <input type="checkbox"/>	Metal <input type="checkbox"/>	Upholstered <input type="checkbox"/>	Castors <input type="checkbox"/>

NOTES

- Leather/Fabric MIX CATEGORIES are based on the STARTING PRICE CATEGORY OF LEATHER combined with fabric = cat. 1A (cat.10 + fabric) - 1B (cat.15 + fabric) - 2A (cat. 20 ...) - 2B (cat. 25 ...) - 3A (cat. 30 ...) - 3B (cat. 35 ...) - 4A (cat. 40 ...) - 5E (cat. 55 ...)
- FABRIC: In fabric contrast welt (as well as any another decorative detail such as a band under arm cushion or backrest or inserts) can be made with any color of art. Le Mans.
- Model is not available with article Misterbianco (cat. 30).
- Vers. 066: Metal base available in metal finishings 79 (Matte Black)
- Tight Seat Cushion (the seat cushions of the models are fixed to the frame)
- Tight Back Cushion (the back cushions of the models are fixed to the frame)
- Internal wooden frame.
- Feet will be in a bag inside the package and requires assembling.
- Feet available in wooden finishings 29 (Oak Coffee) / 32 (Smoked Oak)
- Feet height 18,0 cm
- LEATHER-FABRIC MIX COVERING OPTIONS:
- 1° COV. (Leather) = Outer body & Welt
- 2° COV. (Fabric) = Inner body and seat cushion

NOTES

---



■ Vers. 009



■ Vers. 009



■ Vers. 009

## SCHEMATICS

---

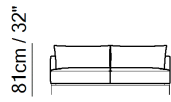
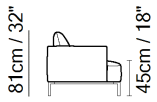

009

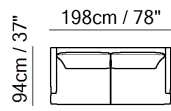

009

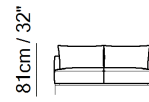



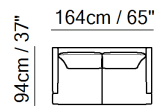

005



005

TECHNICAL INFORMATION

	<b>COVERING</b>	Leather <input checked="" type="checkbox"/>	Soft Cover <input checked="" type="checkbox"/>				
	<b>FILLING</b>	Arms	<input type="checkbox"/> Fiber <input checked="" type="checkbox"/> Foam <input type="checkbox"/> Feather/Fiber Mix <input type="checkbox"/> Feather	Seat cushion	<input type="checkbox"/> Fiber <input checked="" type="checkbox"/> Foam <input type="checkbox"/> Feather/Fiber Mix <input type="checkbox"/> Feather	Back cushion	<input type="checkbox"/> Fiber <input checked="" type="checkbox"/> Foam <input type="checkbox"/> Feather/Fiber Mix <input type="checkbox"/> Feather
	<b>COMFORT</b>	Standard Comfort <input checked="" type="checkbox"/>	Firm Comfort <input type="checkbox"/>				
	<b>FUNCTION</b>	Bed <input type="checkbox"/>	Electric motion <input type="checkbox"/>	Motion <input type="checkbox"/>	Recliner <input type="checkbox"/>	Sliding <input type="checkbox"/>	
	<b>LEGS</b>	Wood <input type="checkbox"/>	Metal <input checked="" type="checkbox"/>	Plastic <input type="checkbox"/>	Castors <input type="checkbox"/>	Upholstered <input type="checkbox"/>	

NOTES

- Comfort and compactness are combined with an essential, contemporary design, enhanced by high-quality materials and workmanship.
- Model is not available with article Misterbianco (cat. 30).
- Tight Seat Cushion (the seat cushions of the models are fixed to the frame)
- Back Cushion Zippered (the back cushion is attached to the frame through a zipper)
- Internal wooden frame.
- Feet will be in a bag inside the package and requires assembling.
- Feet available in metal finishings 77 (Glossy Chromed) / 78 (Black Chrome)
- Feet height 21,0 cm

NOTES

---



■ Vers. 018+489+073



■ Vers. 018+489+073



■ Vers. 018+489+073



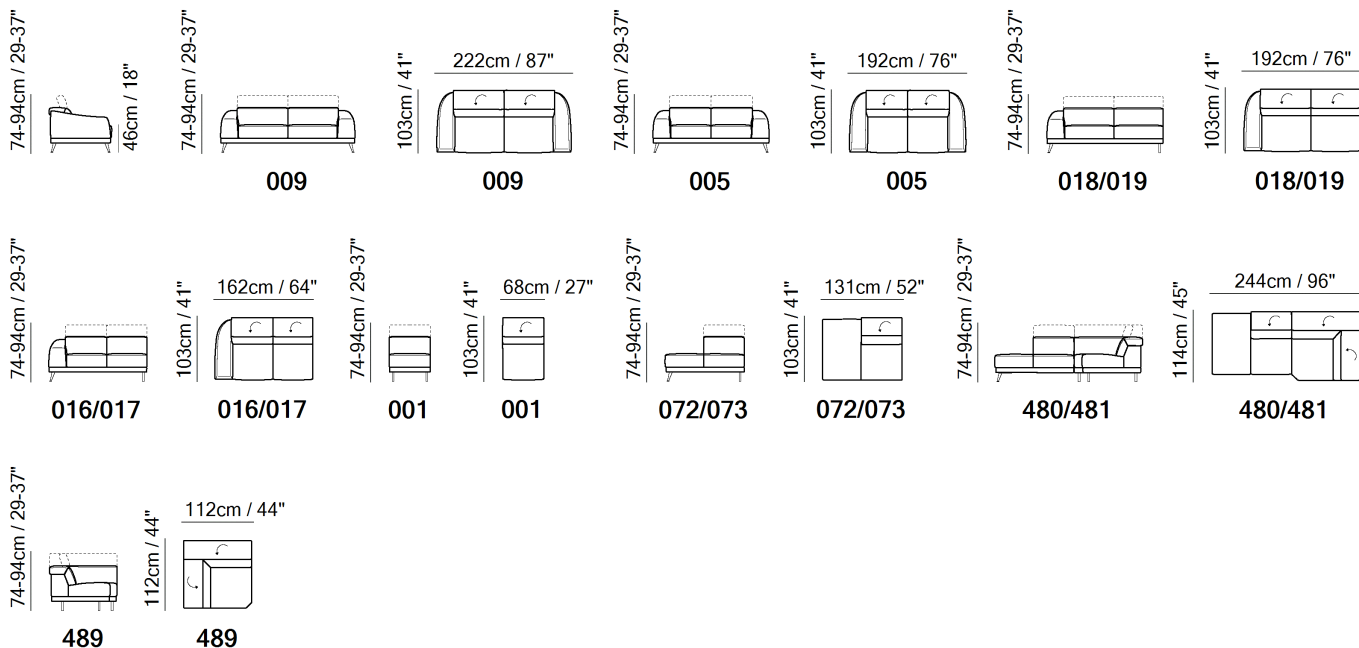

SCHEMATICS

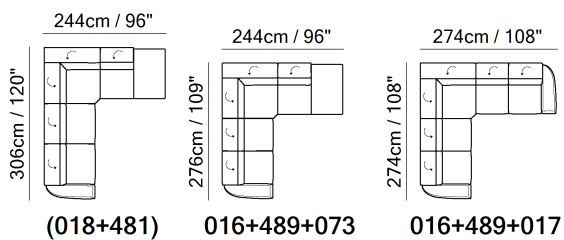

COMPOSITION EXAMPLES



TECHNICAL INFORMATION

	<b>COVERING</b>	Leather <input checked="" type="checkbox"/>	Soft Cover <input checked="" type="checkbox"/>				
	<b>FILLING</b>	Arms	<input type="checkbox"/> Fiber <input checked="" type="checkbox"/> Foam <input type="checkbox"/> Feather/Fiber Mix <input type="checkbox"/> Feather	Seat cushion	<input type="checkbox"/> Fiber <input checked="" type="checkbox"/> Foam <input type="checkbox"/> Feather/Fiber Mix <input type="checkbox"/> Feather	Back cushion	<input type="checkbox"/> Fiber <input checked="" type="checkbox"/> Foam <input type="checkbox"/> Feather/Fiber Mix <input type="checkbox"/> Feather
	<b>COMFORT</b>	Standard Comfort <input checked="" type="checkbox"/>	Firm Comfort <input type="checkbox"/>				
	<b>FUNCTION</b>	Bed <input type="checkbox"/>	Electric motion <input type="checkbox"/>	Motion <input type="checkbox"/>	Recliner <input type="checkbox"/>	Sliding <input type="checkbox"/>	
	<b>LEGS</b>	Wood <input type="checkbox"/>	Plastic <input type="checkbox"/>	Metal <input checked="" type="checkbox"/>	Upholstered <input type="checkbox"/>	Castors <input type="checkbox"/>	

NOTES

- Metropolitan contemporaneity enters the living room, enhancing its value and elegance. An extremely versatile formal sofa, which is suitable for any environment.
- Contrast stitching is available only with certain covers and option is managed directly in NARES.
- Second option version corner 489 has both headrests adjustable.
- Tight Seat Cushion (the seat cushions of the models are fixed to the frame)
- Tight Back Cushion (the back cushions of the models are fixed to the frame)
- With Leather Side (the sectional pieces come with leather sides)
- Internal wooden frame.
- Feet will be in a bag inside the package and requires assembling.
- Feet available in metal finishings 77 (Glossy Chromed) / 78 (Black Chrome)
- Feet height 15,5 cm

NOTES

---



■ Vers. T66



■ Vers. 272+291+049



■ Vers. 003



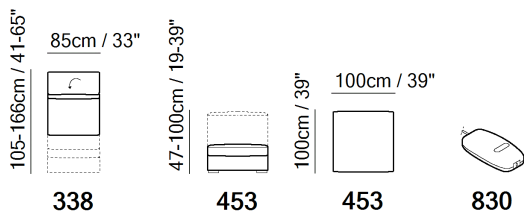
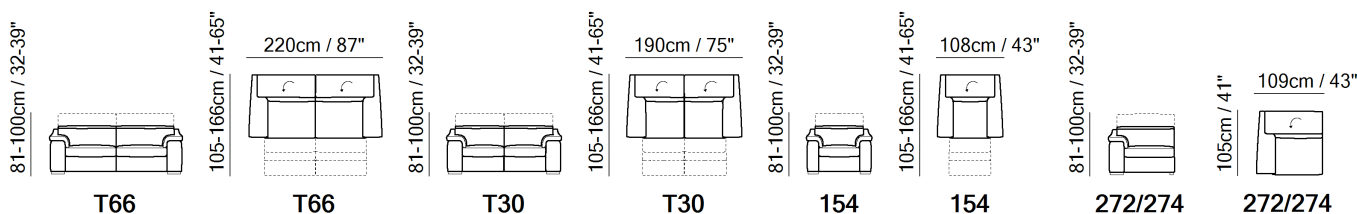
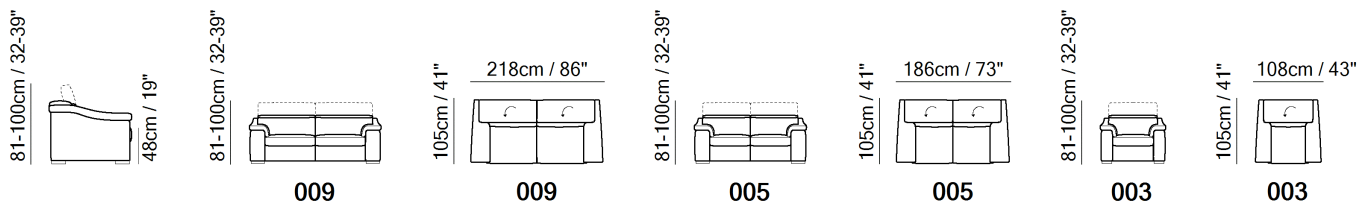

## SCHEMATICS

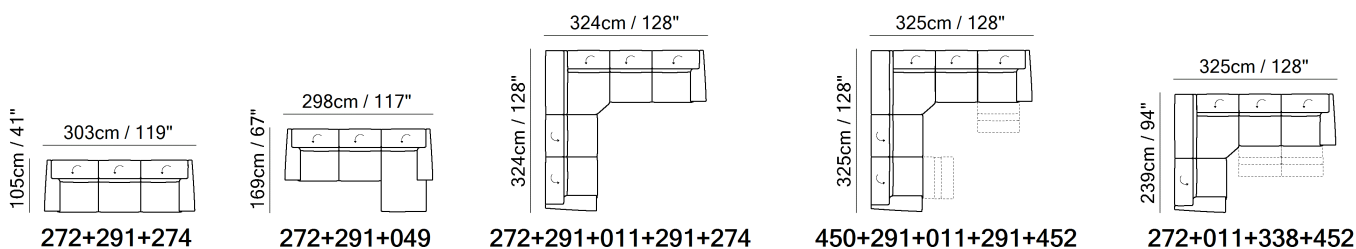

## COMPOSITION EXAMPLES



TECHNICAL INFORMATION

	<b>COVERING</b>	Leather <input checked="" type="checkbox"/>	Soft Cover <input checked="" type="checkbox"/>				
	<b>FILLING</b>	Arms	<input type="checkbox"/> Fiber <input checked="" type="checkbox"/> Foam <input type="checkbox"/> Feather/Fiber Mix <input type="checkbox"/> Feather	Seat cushion	<input type="checkbox"/> Fiber <input checked="" type="checkbox"/> Foam <input type="checkbox"/> Feather/Fiber Mix <input type="checkbox"/> Feather	Back cushion	<input type="checkbox"/> Fiber <input checked="" type="checkbox"/> Foam <input type="checkbox"/> Feather/Fiber Mix <input type="checkbox"/> Feather
	<b>COMFORT</b>	Standard Comfort <input checked="" type="checkbox"/>	Firm Comfort <input type="checkbox"/>				
	<b>FUNCTION</b>	Bed <input type="checkbox"/>	Electric motion <input checked="" type="checkbox"/>	Motion <input checked="" type="checkbox"/>	Recliner <input checked="" type="checkbox"/>	Sliding <input type="checkbox"/>	
	<b>LEGS</b>	Wood <input checked="" type="checkbox"/>	Metal <input type="checkbox"/>	Plastic <input type="checkbox"/>	Castors <input type="checkbox"/>	Upholstered <input type="checkbox"/>	

NOTES

- Designed by Natuzzi Design Center.
- Date of launch: 2017.
- A highly comfortable classic, which offers remarkably versatile configurations and coverings. Its soft design and recliner functions make it ideal for any type of living area.
- Model is not available with article Misterbianco (cat. 30).
- Model is available with contrast welt (or any another decorative detail such as a band under arm cushion) to be entered as second covering in the same category.
- Thanks to ZeroWall mechanism, seat and back cushions can be reclined at a great length without moving sofa away from the wall.
- Stationary versions have manually adjustable headrests.
- A battery pack can be ordered with its own version code 830. For order entry please use XX for category and XXX for cover code. In order to optimize the duration of the battery, it is suggested to order one per each motion seat.
- Seat and back cushions are fixed to the frame.
- No Leather/Fabric Side (the sectional pieces have the side covered with lining and not leather nor fabric)
- Internal wooden frame.
- Feet will be in a bag inside the package and requires assembling.
- Feet available in wood finishings 09 (Walnut) / 18 (Wengè)
- Feet height 4,0 cm

NOTES

---



■ Vers. 003



■ Vers. 066

## SCHEMATICS

---

70cm / 28"  
44cm / 17"



70cm / 28"



003

78cm / 31"  
78cm / 31"



003

70cm / 28"  
44cm / 17"



70cm / 28"







066

78cm / 31"  
78cm / 31"



066

## TECHNICAL INFORMATION

	<b>COVERING</b>	Mix <input checked="" type="checkbox"/>	Leather <input checked="" type="checkbox"/>	Soft Cover <input checked="" type="checkbox"/>		
	<b>FILLING</b>	Arms <input type="checkbox"/> Fiber <input checked="" type="checkbox"/> Foam <input type="checkbox"/> Feather/Fiber Mix <input type="checkbox"/> Feather	Seat cushion <input type="checkbox"/> Fiber <input checked="" type="checkbox"/> Foam <input type="checkbox"/> Feather/Fiber Mix <input type="checkbox"/> Feather	Back cushion <input type="checkbox"/> Fiber <input checked="" type="checkbox"/> Foam <input type="checkbox"/> Feather/Fiber Mix <input type="checkbox"/> Feather		
	<b>COMFORT</b>	Standard Comfort <input checked="" type="checkbox"/>	Firm Comfort <input type="checkbox"/>			
	<b>FUNCTION</b>	Bed <input type="checkbox"/>	Electric motion <input type="checkbox"/>	Motion <input type="checkbox"/>	Recliner <input type="checkbox"/>	Sliding <input type="checkbox"/>
	<b>LEGS</b>	Wood <input type="checkbox"/>	Plastic <input type="checkbox"/>	Metal <input checked="" type="checkbox"/>	Upholstered <input type="checkbox"/>	Castors <input type="checkbox"/>

## NOTES

- Leather/Fabric MIX CATEGORIES are based on the STARTING PRICE CATEGORY OF LEATHER combined with fabric = cat. 1A (cat.10 + fabric) - 1B (cat.15 + fabric) - 2A (cat. 20 ...) - 2B (cat. 25 ...) - 3A (cat. 30 ...) - 3B (cat. 35 ...) - 4A (cat. 40 ...) - 5E (cat. 55 ...)
- Model is not available with article Misterbianco (cat. 30).
- Tight Seat Cushion (the seat cushions of the models are fixed to the frame)
- Tight Back Cushion (the back cushions of the models are fixed to the frame)
- Internal wooden frame.
- Feet will be in a bag inside the package and requires assembling.
- Feet available in metal finishings 77 (Glossy Chromed) / 78 (Black Chrome)
- Vers. 066: Metal base available in metal finishings 79 (Matte Black)
- Feet height 12,5 cm
- LEATHER-FABRIC MIX COVERING OPTIONS:
- 1° COV. (Leather) = Inner back cushion
- 2° COV. (Fabric) = Outer body and seat cushion

NOTES

---



■ Vers. 003



■ Vers. 003





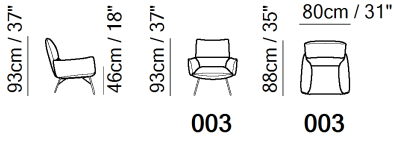

■ Vers. 003

SCHEMATICS

---



TECHNICAL INFORMATION

	<b>COVERING</b>	Mix <input checked="" type="checkbox"/>	Leather <input checked="" type="checkbox"/>	Soft Cover <input checked="" type="checkbox"/>			
	<b>FILLING</b>	Arms	<input type="checkbox"/> Fiber <input checked="" type="checkbox"/> Foam <input type="checkbox"/> Feather/Fiber Mix <input type="checkbox"/> Feather	Seat cushion	<input type="checkbox"/> Fiber <input checked="" type="checkbox"/> Foam <input type="checkbox"/> Feather/Fiber Mix <input type="checkbox"/> Feather	Back cushion	<input type="checkbox"/> Fiber <input checked="" type="checkbox"/> Foam <input type="checkbox"/> Feather/Fiber Mix <input type="checkbox"/> Feather
	<b>COMFORT</b>	Standard Comfort <input checked="" type="checkbox"/>	Firm Comfort <input type="checkbox"/>				
	<b>FUNCTION</b>	Bed <input type="checkbox"/>	Electric motion <input type="checkbox"/>	Motion <input type="checkbox"/>	Recliner <input type="checkbox"/>	Sliding <input type="checkbox"/>	
	<b>LEGS</b>	Wood <input type="checkbox"/>	Metal <input checked="" type="checkbox"/>	Plastic <input type="checkbox"/>	Castors <input type="checkbox"/>	Upholstered <input type="checkbox"/>	

NOTES

- FABRIC: In fabric contrast welt (as well as any another decorative detail such as a band under arm cushion or backrest or inserts) can be made with any color of art. Le Mans.
- Leather/Fabric MIX CATEGORIES are based on the STARTING PRICE CATEGORY OF LEATHER combined with fabric = cat. 1A (cat.10 + fabric) - 1B (cat.15 + fabric) - 2A (cat. 20 ...) - 2B (cat. 25 ...) - 3A (cat. 30 ...) - 3B (cat. 35 ...) - 4A (cat. 40 ...) - 5E (cat. 55 ...)
- Model is not available with article Misterbianco (cat. 30).
- Tight Seat Cushion (the seat cushions of the models are fixed to the frame)
- Tight Back Cushion (the back cushions of the models are fixed to the frame)
- Metal Frame
- Feet will be in a bag inside the package and requires assembling.
- Front feet are slightly higher in respect to rear.
- Feet available in metal finishing 78 (Black Chrome)
- Feet height 33,0/26,5 cm
- LEATHER-FABRIC MIX COVERING OPTIONS:
- 1° COV. (Leather) = Back cushion, seat cushion and welt
- 2° COV. (Fabric) = Base

NOTES

---



■ Vers. 064



■ Vers. N46



■ Vers. 272+291+076+N038+N052



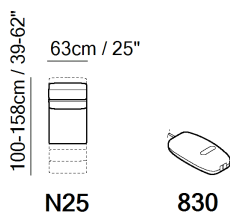
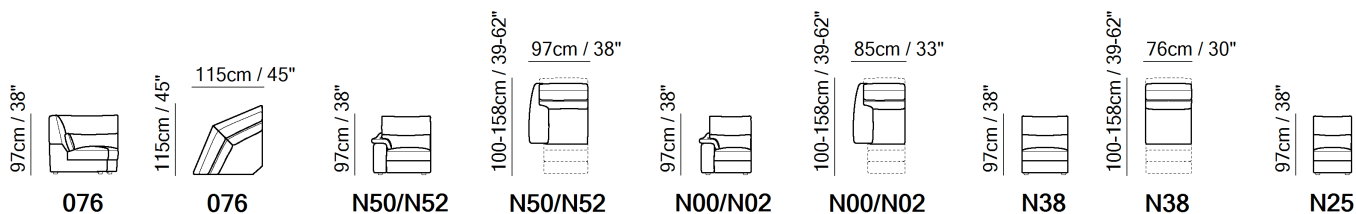
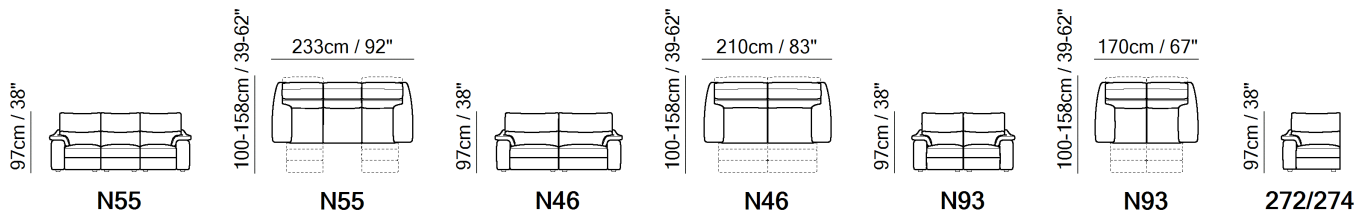
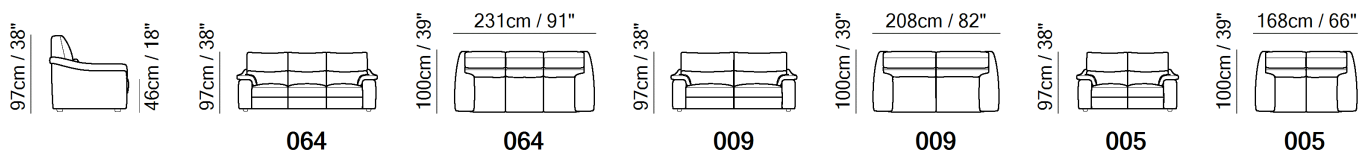

## SCHEMATICS

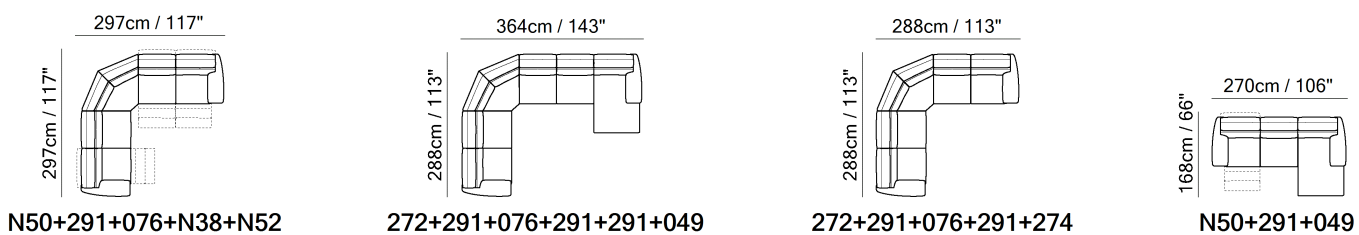

## COMPOSITION EXAMPLES



TECHNICAL INFORMATION

	<b>COVERING</b>	Leather <input checked="" type="checkbox"/>	Soft Cover <input checked="" type="checkbox"/>				
	<b>FILLING</b>	Arms	<input type="checkbox"/> Fiber <input checked="" type="checkbox"/> Foam <input type="checkbox"/> Feather/Fiber Mix <input type="checkbox"/> Feather	Seat cushion	<input type="checkbox"/> Fiber <input checked="" type="checkbox"/> Foam <input type="checkbox"/> Feather/Fiber Mix <input type="checkbox"/> Feather	Back cushion	<input type="checkbox"/> Fiber <input checked="" type="checkbox"/> Foam <input type="checkbox"/> Feather/Fiber Mix <input type="checkbox"/> Feather
	<b>COMFORT</b>	Standard Comfort <input checked="" type="checkbox"/>	Firm Comfort <input type="checkbox"/>				
	<b>FUNCTION</b>	Bed <input type="checkbox"/>	Electric motion <input type="checkbox"/>	Motion <input checked="" type="checkbox"/>	Recliner <input checked="" type="checkbox"/>	Sliding <input type="checkbox"/>	
	<b>LEGS</b>	Wood <input type="checkbox"/>	Plastic <input checked="" type="checkbox"/>	Metal <input type="checkbox"/>	Upholstered <input type="checkbox"/>	Castors <input type="checkbox"/>	

NOTES

- Designed by Natuzzi Design Center.
- Date of launch: 2017.
- A marvel of comfort and technology that combines “triple-motion” functions and an enveloping design. A sofa that brings the value of Natuzzi research and development to every living area.
- Model is not available with article Misterbianco (cat. 30).
- Triple motion mechanism (vers. Nxx) activates footrest, headrest and lumbar support. The power mechanism switch is on the external side panel which also allocates a USB charging port.
- Models with triple motion mechanism have a "home" button that resets from the relax position to the original position all in one movement. The "home" button is the first of the three switches and is activated by continuous pressure.
- Thanks to ZeroWall mechanism, seat and back cushions can be reclined at a great length without moving sofa away from the wall.
- A battery pack can be ordered with its own version code 830. For order entry please use XX for category and XXX for cover code. In order to optimize the duration of the battery, it is suggested to order one per each motion seat.
- Power switch located also allocates a USB charging port.
- Seat and back cushions are fixed to the frame.
- Internal wooden frame.
- Feet will be in a bag inside the package and requires assembling.
- Feet height 4,5 cm

NOTES

---



■ Vers. 197



■ Vers. 003



■ Vers. 003

SCHEMATICS

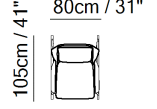
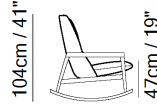
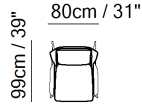





003

003

196

196

TECHNICAL INFORMATION

	<b>COVERING</b>	Soft Cover <input checked="" type="checkbox"/>					
	<b>FILLING</b>	Arms	<input type="checkbox"/> Fiber <input checked="" type="checkbox"/> Foam <input type="checkbox"/> Feather/Fiber Mix <input checked="" type="checkbox"/> Feather	Seat cushion	<input type="checkbox"/> Fiber <input checked="" type="checkbox"/> Foam <input type="checkbox"/> Feather/Fiber Mix <input checked="" type="checkbox"/> Feather	Back cushion	<input type="checkbox"/> Fiber <input checked="" type="checkbox"/> Foam <input type="checkbox"/> Feather/Fiber Mix <input checked="" type="checkbox"/> Feather
	<b>COMFORT</b>	Standard Comfort <input checked="" type="checkbox"/>	Firm Comfort <input type="checkbox"/>				
	<b>FUNCTION</b>	Bed <input type="checkbox"/>	Electric motion <input type="checkbox"/>	Motion <input type="checkbox"/>	Recliner <input type="checkbox"/>	Sliding <input type="checkbox"/>	
	<b>LEGS</b>	Wood <input checked="" type="checkbox"/>	Metal <input type="checkbox"/>	Plastic <input type="checkbox"/>	Castors <input type="checkbox"/>	Upholstered <input type="checkbox"/>	

NOTES

- Designed by Mauro Lipparini.
- Date of launch: 2018.
- Margaret, a distinctive chair that gets its peculiarity from the curved cocoon shaped back in rawhide. The combination of natural materials such as solid wood and genuine rawhide give it a noble look. An element of pure design that enriches any environment.
- Frame in saddle leather in a dark brown colour.
- Available also as a rocking chair (version 196)
- Seat and back cushions aren't fixed to the frame.
- Internal wooden frame.
- With Feet Assembled (the model will be loaded with feet already mounted on the sofa).
- Feet available in wooden finishings 32 (Smoked Oak) / 39 (European Walnut)

NOTES

---



■ Vers. 003



■ Vers. 003





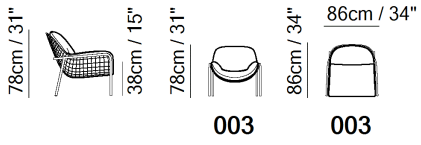

■ Vers. 003

SCHEMATICS

---



TECHNICAL INFORMATION

	<b>COVERING</b>	Leather <input checked="" type="checkbox"/>	Soft Cover <input checked="" type="checkbox"/>				
	<b>FILLING</b>	Arms	<input type="checkbox"/> Fiber <input checked="" type="checkbox"/> Foam <input type="checkbox"/> Feather/Fiber Mix <input type="checkbox"/> Feather	Seat cushion	<input type="checkbox"/> Fiber <input checked="" type="checkbox"/> Foam <input type="checkbox"/> Feather/Fiber Mix <input type="checkbox"/> Feather	Back cushion	<input type="checkbox"/> Fiber <input checked="" type="checkbox"/> Foam <input type="checkbox"/> Feather/Fiber Mix <input type="checkbox"/> Feather
	<b>COMFORT</b>	Standard Comfort <input checked="" type="checkbox"/>	Firm Comfort <input type="checkbox"/>				
	<b>FUNCTION</b>	Bed <input type="checkbox"/>	Electric motion <input type="checkbox"/>	Motion <input type="checkbox"/>	Recliner <input type="checkbox"/>	Sliding <input type="checkbox"/>	
	<b>LEGS</b>	Wood <input type="checkbox"/>	Plastic <input type="checkbox"/>	Metal <input checked="" type="checkbox"/>	Upholstered <input type="checkbox"/>	Castors <input type="checkbox"/>	

NOTES

- Model is not available with article Misterbianco (cat. 30).
- Loose Seat Cushion (the seat cushions of the model are not fixed to the frame)
- Loose Back Cushion (the back cushions of the model are not fixed to the frame)
- Metal Frame
- With Feet Assembled (the model will be loaded with feet already mounted on the sofa).
- Feet available in metal finishing 77 (Glossy Chromed)
- Feet height 27,0 cm

NOTES

---



■ Vers. 003



■ Vers. 003





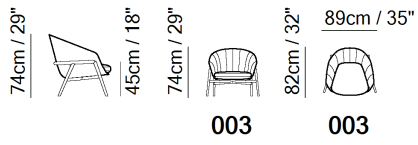

■ Vers. 003

SCHEMATICS

---



TECHNICAL INFORMATION

	<b>COVERING</b>	Mix <input checked="" type="checkbox"/>	Leather <input checked="" type="checkbox"/>	Soft Cover <input checked="" type="checkbox"/>		
	<b>FILLING</b>	Arms <input type="checkbox"/> Fiber <input checked="" type="checkbox"/> Foam <input type="checkbox"/> Feather/Fiber Mix <input type="checkbox"/> Feather	Seat cushion <input type="checkbox"/> Fiber <input checked="" type="checkbox"/> Foam <input type="checkbox"/> Feather/Fiber Mix <input type="checkbox"/> Feather	Back cushion <input type="checkbox"/> Fiber <input checked="" type="checkbox"/> Foam <input type="checkbox"/> Feather/Fiber Mix <input type="checkbox"/> Feather		
	<b>COMFORT</b>	Standard Comfort <input checked="" type="checkbox"/>	Firm Comfort <input type="checkbox"/>			
	<b>FUNCTION</b>	Bed <input type="checkbox"/>	Electric motion <input type="checkbox"/>	Motion <input type="checkbox"/>	Recliner <input type="checkbox"/>	Sliding <input type="checkbox"/>
	<b>LEGS</b>	Wood <input checked="" type="checkbox"/>	Metal <input type="checkbox"/>	Plastic <input type="checkbox"/>	Castors <input type="checkbox"/>	Upholstered <input type="checkbox"/>

NOTES

- Leather/Fabric MIX CATEGORIES are based on the STARTING PRICE CATEGORY OF LEATHER combined with fabric = cat. 1A (cat.10 + fabric) - 1B (cat.15 + fabric) - 2A (cat. 20 ...) - 2B (cat. 25 ...) - 3A (cat. 30 ...) - 3B (cat. 35 ...) - 4A (cat. 40 ...) - 5E (cat. 55 ...)
- Model is not available with article Misterbianco (cat. 30).
- Tight Seat Cushion (the seat cushions of the models are fixed to the frame)
- Tight Back Cushion (the back cushions of the models are fixed to the frame)
- Metal Frame
- With Feet Assembled (the model will be loaded with feet already mounted on the sofa).
- Feet available in wooden finishings 32 (Smoked Oak) / 39 (European Walnut)
- LEATHER-FABRIC MIX COVERING OPTIONS:
- 1° COV. (Leather) = Frame
- 2° COV. (Fabric) = Seat cushions

NOTES

---



■ Vers. 003



■ Vers. 003





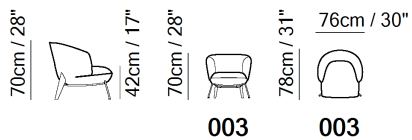

■ Vers. 003

SCHEMATICS

---



TECHNICAL INFORMATION

	<b>COVERING</b>	Mix <input checked="" type="checkbox"/>	Leather <input checked="" type="checkbox"/>	Soft Cover <input checked="" type="checkbox"/>		
	<b>FILLING</b>	Arms	<input type="checkbox"/> Fiber <input checked="" type="checkbox"/> Foam <input type="checkbox"/> Feather/Fiber Mix <input type="checkbox"/> Feather	Seat cushion	<input type="checkbox"/> Fiber <input checked="" type="checkbox"/> Foam <input type="checkbox"/> Feather/Fiber Mix <input type="checkbox"/> Feather	Back cushion <input type="checkbox"/> Fiber <input checked="" type="checkbox"/> Foam <input type="checkbox"/> Feather/Fiber Mix <input type="checkbox"/> Feather
	<b>COMFORT</b>	Standard Comfort <input checked="" type="checkbox"/>	Firm Comfort <input type="checkbox"/>			
	<b>FUNCTION</b>	Bed <input type="checkbox"/>	Electric motion <input type="checkbox"/>	Motion <input type="checkbox"/>	Recliner <input type="checkbox"/>	Sliding <input type="checkbox"/>
	<b>LEGS</b>	Wood <input checked="" type="checkbox"/>	Plastic <input type="checkbox"/>	Metal <input type="checkbox"/>	Upholstered <input type="checkbox"/>	Castors <input type="checkbox"/>

NOTES

- Leather/Fabric MIX CATEGORIES are based on the STARTING PRICE CATEGORY OF LEATHER combined with fabric = cat. 1A (cat.10 + fabric) - 1B (cat.15 + fabric) - 2A (cat. 20 ...) - 2B (cat. 25 ...) - 3A (cat. 30 ...) - 3B (cat. 35 ...) - 4A (cat. 40 ...) - 5E (cat. 55 ...)
- Model is not available with article Misterbianco (cat. 30).
- Tight Seat Cushion (the seat cushions of the models are fixed to the frame)
- Tight Back Cushion (the back cushions of the models are fixed to the frame)
- Metal Frame
- With Feet Assembled (the model will be loaded with feet already mounted on the sofa).
- Front feet of the model is always in black chrome metal, whilst the rear feet are in wood finishing.
- Feet available in wooden finishings 32 (Smoked Oak) / 39 (European Walnut)
- LEATHER-FABRIC MIX COVERING OPTIONS:
- 1° COV. (Leather) = Frame, seat cushion and welt
- 2° COV. (Fabric) = Back cushions

NOTES

---



■ Vers. 066



■ Vers. 066





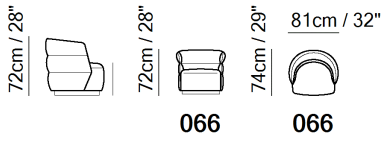

■ Vers. 066

## SCHEMATICS

---



TECHNICAL INFORMATION

	<b>COVERING</b>	Leather <input checked="" type="checkbox"/>	Soft Cover <input checked="" type="checkbox"/>				
	<b>FILLING</b>	Arms	<input type="checkbox"/> Fiber <input checked="" type="checkbox"/> Foam <input type="checkbox"/> Feather/Fiber Mix <input type="checkbox"/> Feather	Seat cushion	<input type="checkbox"/> Fiber <input checked="" type="checkbox"/> Foam <input type="checkbox"/> Feather/Fiber Mix <input type="checkbox"/> Feather	Back cushion	<input type="checkbox"/> Fiber <input checked="" type="checkbox"/> Foam <input type="checkbox"/> Feather/Fiber Mix <input type="checkbox"/> Feather
	<b>COMFORT</b>	Standard Comfort <input checked="" type="checkbox"/>	Firm Comfort <input type="checkbox"/>				
	<b>FUNCTION</b>	Bed <input type="checkbox"/>	Electric motion <input type="checkbox"/>	Motion <input type="checkbox"/>	Recliner <input type="checkbox"/>	Sliding <input type="checkbox"/>	
	<b>LEGS</b>	Wood <input type="checkbox"/>	Metal <input checked="" type="checkbox"/>	Plastic <input type="checkbox"/>	Castors <input type="checkbox"/>	Upholstered <input type="checkbox"/>	

NOTES

- Model is not available with article Misterbianco (cat. 30).
- Tight Seat Cushion (the seat cushions of the models are fixed to the frame)
- Tight Back Cushion (the back cushions of the models are fixed to the frame)
- Internal wooden frame.
- With Feet Assembled (the model will be loaded with feet already mounted on the sofa).
- Feet available in metal finishing 78 (Black Chrome)

NOTES

---



■ Vers. 012



■ Vers. 012+010





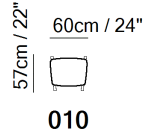
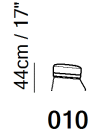
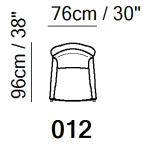

■ Vers. 012

SCHEMATICS

---



TECHNICAL INFORMATION

	<b>COVERING</b>	Leather <input checked="" type="checkbox"/>	Soft Cover <input checked="" type="checkbox"/>				
	<b>FILLING</b>	Arms	<input type="checkbox"/> Fiber <input checked="" type="checkbox"/> Foam <input type="checkbox"/> Feather/Fiber Mix <input type="checkbox"/> Feather	Seat cushion	<input type="checkbox"/> Fiber <input checked="" type="checkbox"/> Foam <input type="checkbox"/> Feather/Fiber Mix <input type="checkbox"/> Feather	Back cushion	<input type="checkbox"/> Fiber <input checked="" type="checkbox"/> Foam <input type="checkbox"/> Feather/Fiber Mix <input type="checkbox"/> Feather
	<b>COMFORT</b>	Standard Comfort <input checked="" type="checkbox"/>	Firm Comfort <input type="checkbox"/>				
	<b>FUNCTION</b>	Bed <input type="checkbox"/>	Electric motion <input type="checkbox"/>	Motion <input type="checkbox"/>	Recliner <input type="checkbox"/>	Sliding <input type="checkbox"/>	
	<b>LEGS</b>	Wood <input type="checkbox"/>	Plastic <input type="checkbox"/>	Metal <input checked="" type="checkbox"/>	Upholstered <input type="checkbox"/>	Castors <input type="checkbox"/>	

NOTES

- Tight Seat Cushion (the seat cushions of the models are fixed to the frame)
- Tight Back Cushion (the back cushions of the models are fixed to the frame)
- Internal wooden frame.
- Feet will be in a bag inside the package and requires assembling.
- Front feet are slightly higher in respect to rear.
- Feet available in metal finishings 75 (Glazed Nickel) / 78 (Black Chrome)
- Feet height 23,0/15,0 cm

NOTES

---



■ Vers. 064+109+109+152+152



■ Vers. 009+109+152







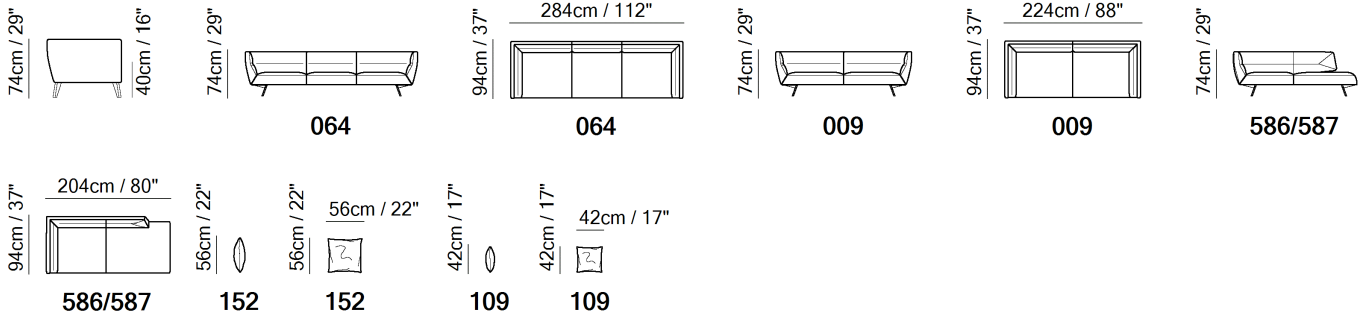

■ Vers. 586

**SCHEMATICS**



TECHNICAL INFORMATION

	<b>COVERING</b>	Leather <input checked="" type="checkbox"/>	Soft Cover <input checked="" type="checkbox"/>			
	<b>FILLING</b>	Arms <input type="checkbox"/> Fiber <input checked="" type="checkbox"/> Foam <input type="checkbox"/> Feather/Fiber Mix <input type="checkbox"/> Feather	Seat cushion <input type="checkbox"/> Fiber <input checked="" type="checkbox"/> Foam <input type="checkbox"/> Feather/Fiber Mix <input type="checkbox"/> Feather	Back cushion <input checked="" type="checkbox"/> Fiber <input type="checkbox"/> Foam <input type="checkbox"/> Feather/Fiber Mix <input type="checkbox"/> Feather		
	<b>COMFORT</b>	Standard Comfort <input checked="" type="checkbox"/>	Firm Comfort <input type="checkbox"/>			
	<b>FUNCTION</b>	Bed <input type="checkbox"/>	Electric motion <input type="checkbox"/>	Motion <input type="checkbox"/>	Recliner <input type="checkbox"/>	Sliding <input type="checkbox"/>
	<b>VISUAL APPEARANCE*</b>	Low <input type="checkbox"/>	Medium <input checked="" type="checkbox"/>	High <input type="checkbox"/>		
	<b>LEGS</b>	Wood <input checked="" type="checkbox"/>	Metal <input type="checkbox"/>	Plastic <input type="checkbox"/>	Castors <input type="checkbox"/>	Upholstered <input type="checkbox"/>

VISUAL APPEARANCE

The product may reveal various wrinkles due to the combination of Elasticity of the covering, characteristics of the interior construction and the design of the product.



Products with Visual Appearance listed as High or Medium would require higher degree of care, where seats and back cushions may require fluffing and plumping more often than Products with Visual Appearance listed as Low.

NOTES

- Essential lines embellished by the decorative stitching on the back seat cushions and by the base in solid smoked oak 32 with details in brushed brass.
- Optional loose pillows (vers. 109-152) are available in two different sizes to improve comfort.
- Model is not available with article Misterbianco (cat. 30).
- Comfort >> The mix of padding in polyurethane and Climalight (special latest-generation silicone microfibre) guarantees a look and support that does not change over time.
- Tight Seat Cushion (the seat cushions of the models are fixed to the frame)
- Tight Back Cushion (the back cushions of the models are fixed to the frame)
- With Leather Side (the sectional pieces come with leather sides)
- Internal wooden frame.
- Feet will be in a bag inside the package and requires assembling.
- Feet available in wooden finishings 32 (Smoked Oak)

NOTES

---





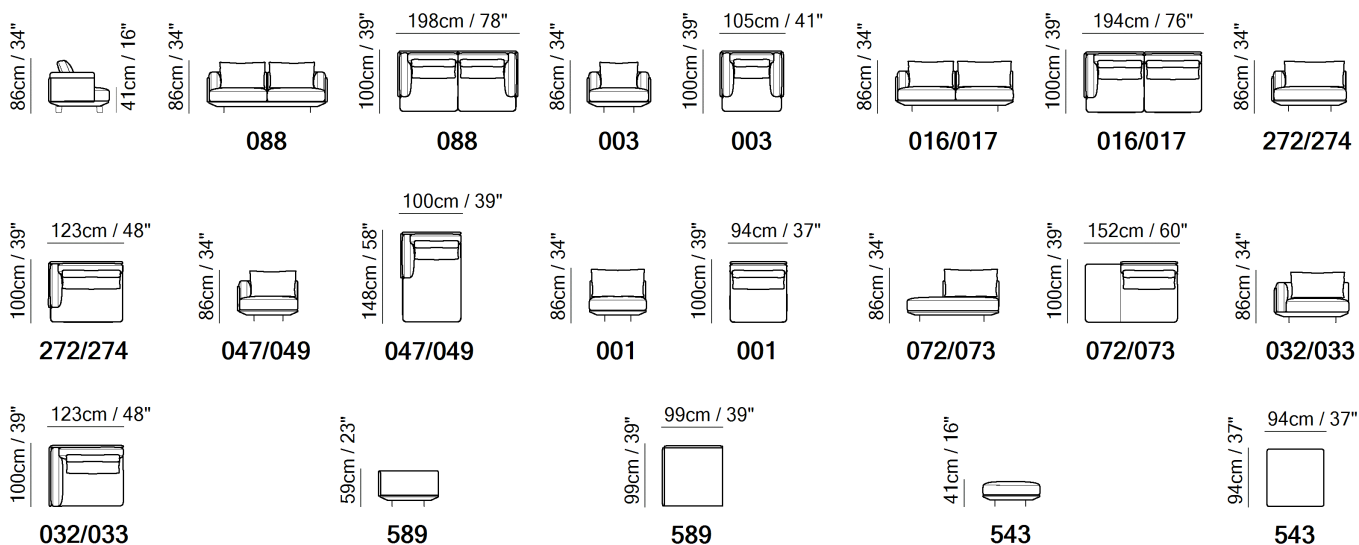

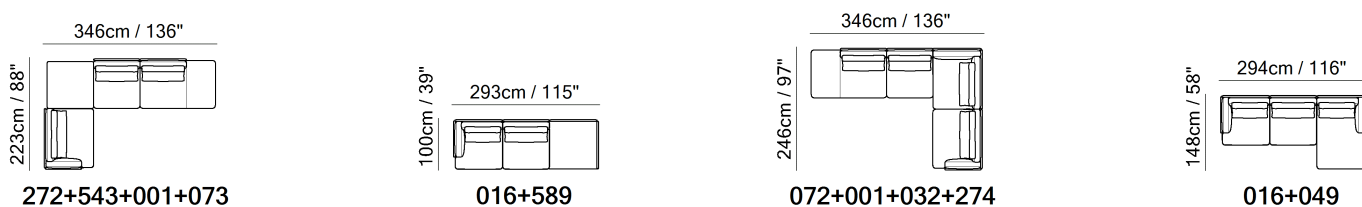

## SCHEMATICS



## COMPOSITION EXAMPLES



TECHNICAL INFORMATION

	<b>COVERING</b>	Leather <input checked="" type="checkbox"/>	Soft Cover <input checked="" type="checkbox"/>			
	<b>FILLING</b>	Arms <input type="checkbox"/> Fiber <input checked="" type="checkbox"/> Foam <input type="checkbox"/> Feather/Fiber Mix <input type="checkbox"/> Feather	Seat cushion <input type="checkbox"/> Fiber <input checked="" type="checkbox"/> Foam <input type="checkbox"/> Feather/Fiber Mix <input type="checkbox"/> Feather	Back cushion <input type="checkbox"/> Fiber <input checked="" type="checkbox"/> Foam <input type="checkbox"/> Feather/Fiber Mix <input type="checkbox"/> Feather		
	<b>COMFORT</b>	Standard Comfort <input checked="" type="checkbox"/>	Firm Comfort <input type="checkbox"/>			
	<b>FUNCTION</b>	Bed <input type="checkbox"/>	Electric motion <input type="checkbox"/>	Motion <input type="checkbox"/>	Recliner <input type="checkbox"/>	Sliding <input type="checkbox"/>
	<b>VISUAL APPEARANCE*</b>	Low <input type="checkbox"/>	Medium <input type="checkbox"/>	High <input checked="" type="checkbox"/>		
	<b>LEGS</b>	Wood <input type="checkbox"/>	Plastic <input type="checkbox"/>	Metal <input checked="" type="checkbox"/>	Upholstered <input type="checkbox"/>	Castors <input type="checkbox"/>

VISUAL APPEARANCE

The product may reveal various wrinkles due to the combination of Elasticity of the covering, characteristics of the interior construction and the design of the product.



Products with Visual Appearance listed as High or Medium would require higher degree of care, where seats and back cushions may require fluffing and plumping more often than Products with Visual Appearance listed as Low.

NOTES

- Designed by Mauro Lipparini.
- Date of launch: 2019.
- The intricate but yet measured, and sophisticated design makes this model a witness of timeless forms and languages, with a modern tract.
- Removable cover in fabric and leather thanks to use of decorative zippers to be ordered as R147. Model available in fabric and leather starting from category 15.
- With the code 3147, it is possible to order CAMPUS outer frame in basket woven suede Gargano, with irregular weaves. The final consumer can choose between 7 colors of suede to match freely with the leather and fabric articles of the Natuzzi Italia collection.
- 3147 LEATHER / SUEDE or FABRIC/SUEDE MIX:
  - First cover is always in leather or fabric;
  - Second cover (back of the frame) is always in basket woven suede (art. Gargano).
- Model is not available with article Misterbianco (cat. 30).
- Seat cushion includes a layer of memory foam, a pressure-sensitive soft polyurethane, that recovers its form completely thus giving great comfort.
- Comfort >> The mix of padding in polyurethane and Climalight (special latest-generation silicone microfibre) guarantees a look and support that does not change over time.
- The version 589 can be used both as a corner and as a terminal module in a linear configuration and it is in tobacco-colored ash wood or eucalyptus wood.

## NOTES

---

- Anti-slip lining under the seat cushions to prevent them from sliding down when seated.
- In leather version module side panels are fully upholstered.
- Seat and back cushions aren't fixed to the frame.
- Internal wooden frame.
- Metal feet available in two finishes: 46 glossy champagne and 79 matt black with anti-scratch foot liners.
- The colour of the zip is always linked with the colour of the feet chosen.  
When the feet finish is champagne (46), the color of the zip is gold.  
When the feet finish is matt black (79), the color of the zip is silver.
- Feet will be in a bag inside the package and requires assembling.



■ Vers. 725+708+790+708+726



■ Vers. 725+708+790+708+726



■ Vers. 543+761+790+708+726



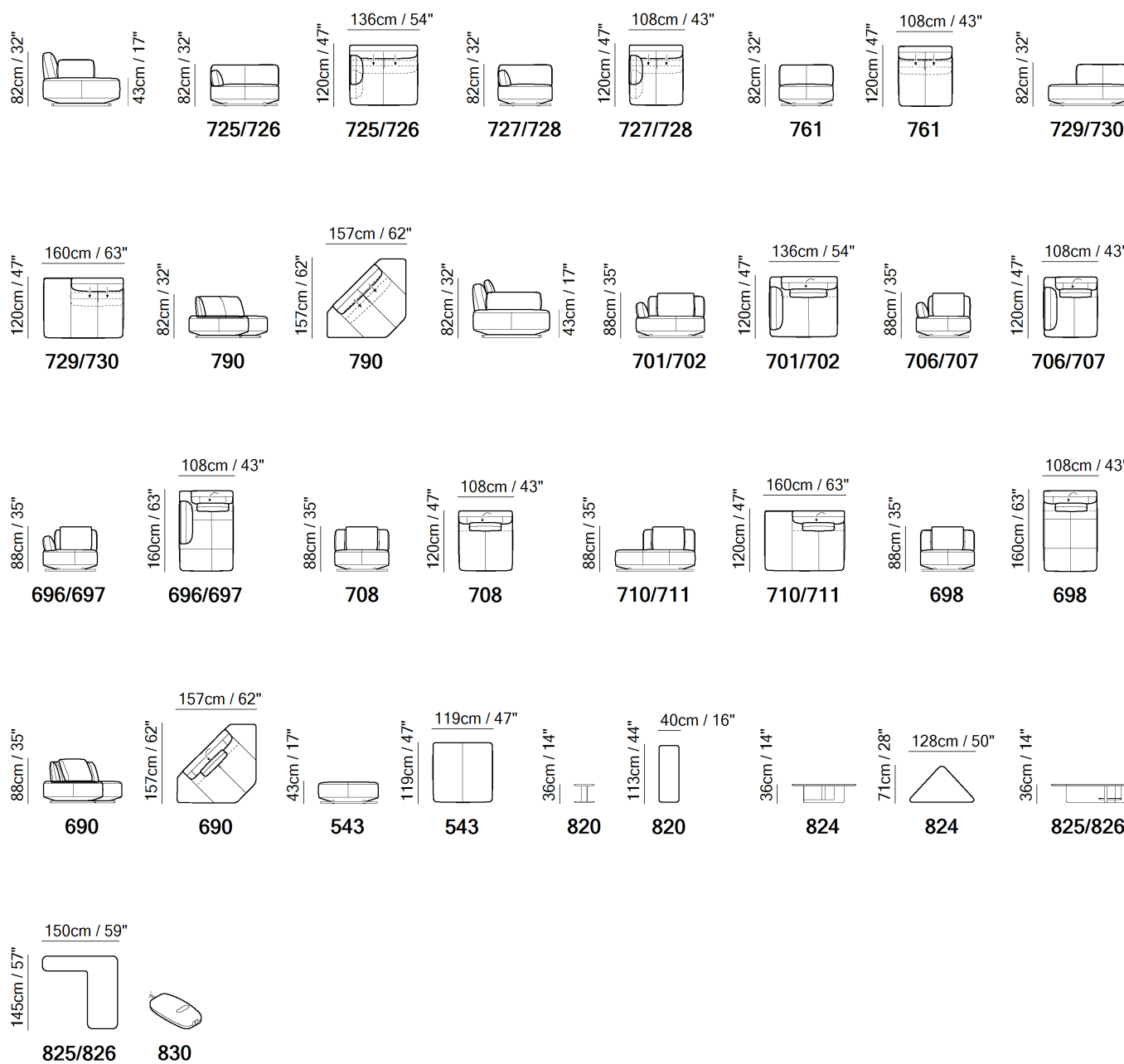

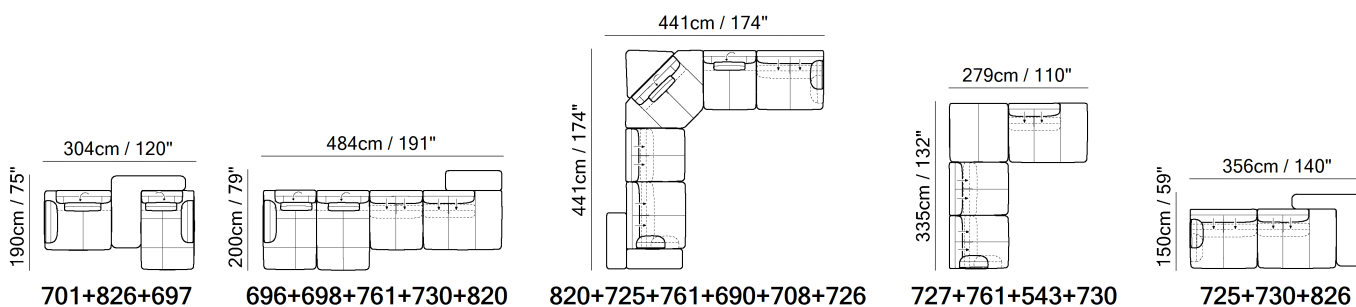

## SCHEMATICS



## COMPOSITION EXAMPLES



TECHNICAL INFORMATION

	<b>COVERING</b>	Leather <input checked="" type="checkbox"/>	Soft Cover <input checked="" type="checkbox"/>				
	<b>FILLING</b>	Arms	<input type="checkbox"/> Fiber <input checked="" type="checkbox"/> Foam <input type="checkbox"/> Feather/Fiber Mix <input type="checkbox"/> Feather	Seat cushion	<input type="checkbox"/> Fiber <input checked="" type="checkbox"/> Foam <input type="checkbox"/> Feather/Fiber Mix <input type="checkbox"/> Feather	Back cushion	<input type="checkbox"/> Fiber <input checked="" type="checkbox"/> Foam <input type="checkbox"/> Feather/Fiber Mix <input type="checkbox"/> Feather
	<b>COMFORT</b>	Standard Comfort <input checked="" type="checkbox"/>	Firm Comfort <input type="checkbox"/>				
	<b>FUNCTION</b>	Bed <input type="checkbox"/>	Electric motion <input type="checkbox"/>	Motion <input type="checkbox"/>	Recliner <input type="checkbox"/>	Sliding <input type="checkbox"/>	
	<b>VISUAL APPEARANCE*</b>	Low <input type="checkbox"/>	Medium <input checked="" type="checkbox"/>	High <input type="checkbox"/>			
	<b>LEGS</b>	Wood <input checked="" type="checkbox"/>	Metal <input type="checkbox"/>	Plastic <input type="checkbox"/>	Castors <input type="checkbox"/>	Upholstered <input type="checkbox"/>	

VISUAL APPEARANCE

The product may reveal various wrinkles due to the combination of Elasticity of the covering, characteristics of the interior construction and the design of the product.



Products with Visual Appearance listed as High or Medium would require higher degree of care, where seats and back cushions may require fluffing and plumping more often than Products with Visual Appearance listed as Low.

NOTES

- Designed by Mauro Lipparini.
- Date of launch: 2019.
- Each module (except corner and chaise-longue) can be ordered in two types of mechanisms: flip or sliding.
- Innovative “Flip” mechanism that allows you to manually change the position of the backrest from vertical to horizontal to find the desired comfort and the best conviviality. Version comes with a scatter pillow.
- The electric sliding mechanism allows the backrest to move forward or backward changing the depth of the seat. This mechanism is activated by two touch buttons placed on the seat.
- The Cava range is completed by 3 different tables (vers 820-824-825/826) in different shapes and sizes with metal frame and top in elm tobacco finish.
- Model is not available with article Misterbianco (cat. 30).
- Seat cushion includes a layer of memory foam, a pressure-sensitive soft polyurethane, that recovers its form completely thus giving great comfort.
- A battery pack can be ordered with its own version code 830. For order entry please use XX for category and XXX for cover code. In order to optimize the duration of the battery, it is suggested to order one per each motion seat.
- Seat and back cushions are fixed to the frame.
- With Leather Side (the sectional pieces come with leather sides)

## NOTES

---

- Feet will be in a bag inside the package and requires assembling.
- The seats are supported by tubular solid wood base in a ash wood tobacco 44 finish combined with metal coffee 85 finish (with anti-scratch foot liners).



■ Vers. 756+799+311+793



■ Vers. 756+759



■ Vers. 450+793



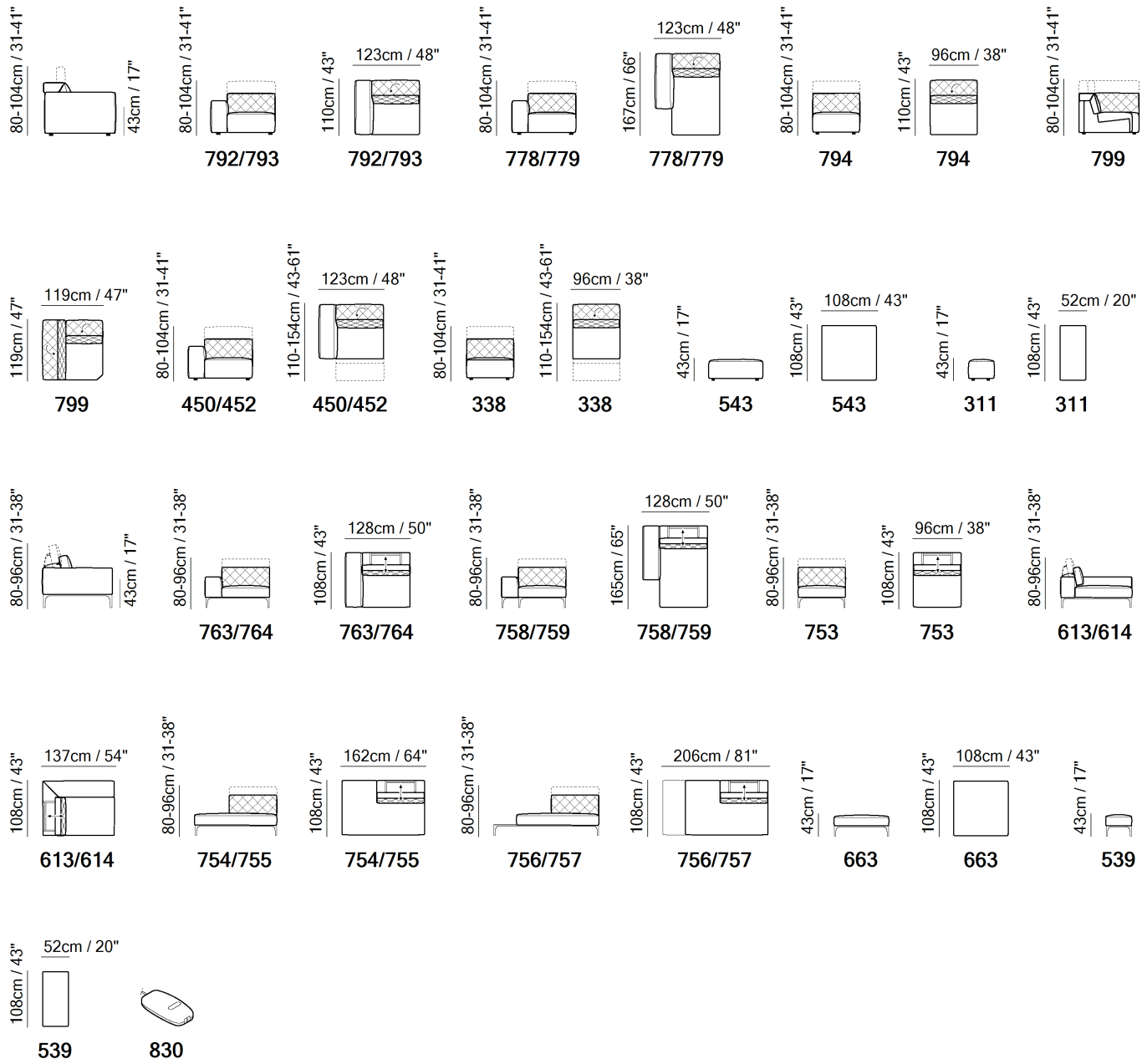

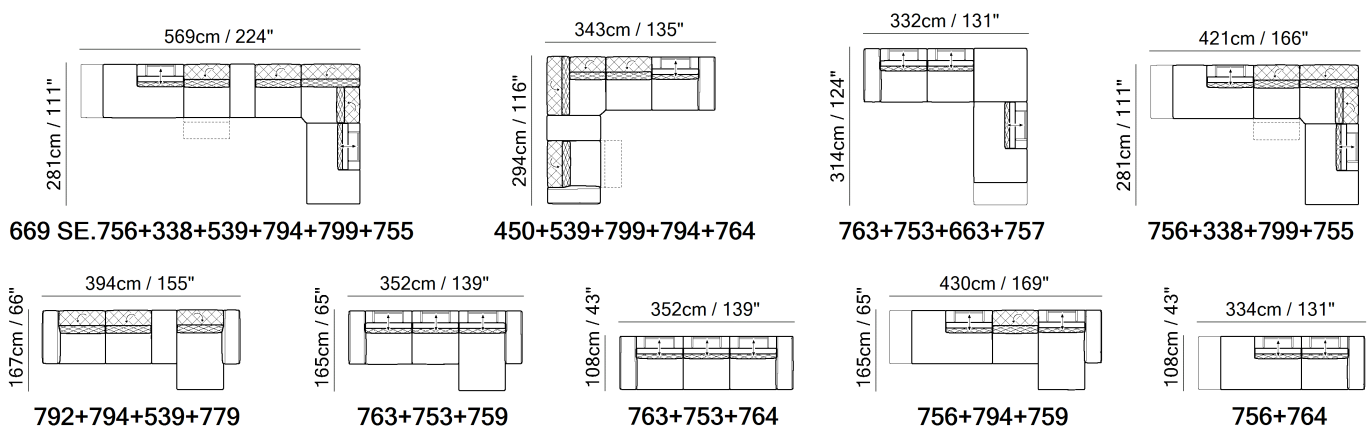

**SCHEMATICS**



**COMPOSITION EXAMPLES**



TECHNICAL INFORMATION

	<b>COVERING</b>	Leather <input checked="" type="checkbox"/>	Soft Cover <input checked="" type="checkbox"/>			
	<b>FILLING</b>	Arms <input type="checkbox"/> Fiber <input checked="" type="checkbox"/> Foam <input type="checkbox"/> Feather/Fiber Mix <input type="checkbox"/> Feather	Seat cushion <input type="checkbox"/> Fiber <input checked="" type="checkbox"/> Foam <input type="checkbox"/> Feather/Fiber Mix <input type="checkbox"/> Feather	Back cushion <input type="checkbox"/> Fiber <input checked="" type="checkbox"/> Foam <input type="checkbox"/> Feather/Fiber Mix <input type="checkbox"/> Feather		
	<b>COMFORT</b>	Standard Comfort <input checked="" type="checkbox"/>	Firm Comfort <input type="checkbox"/>			
	<b>FUNCTION</b>	Bed <input type="checkbox"/>	Electric motion <input checked="" type="checkbox"/>	Motion <input type="checkbox"/>	Recliner <input type="checkbox"/>	Sliding <input type="checkbox"/>
	<b>VISUAL APPEARANCE*</b>	Low <input checked="" type="checkbox"/>	Medium <input type="checkbox"/>	High <input type="checkbox"/>		
	<b>LEGS</b>	Wood <input type="checkbox"/> Castors <input type="checkbox"/>	Plastic <input type="checkbox"/>	Metal <input checked="" type="checkbox"/>	Metal <input checked="" type="checkbox"/>	Upholstered <input type="checkbox"/>

VISUAL APPEARANCE

The product may reveal various wrinkles due to the combination of Elasticity of the covering, characteristics of the interior construction and the design of the product.



Products with Visual Appearance listed as High or Medium would require higher degree of care, where seats and back cushions may require fluffing and plumping more often than Products with Visual Appearance listed as Low.

NOTES

- Designed by Marcel Wanders Studio.
- Date of launch: 2019.
- Model is not available with article Misterbianco (cat. 30).
- To allow modularity, the single elements can be put together thanks to the rubber stops under the legs.
- Thanks to ZeroWall mechanism, seat and back cushions can be reclined at a great length without moving sofa away from the wall.
- A battery pack can be ordered with its own version code 830. For order entry please use XX for category and XXX for cover code. In order to optimize the duration of the battery, it is suggested to order one per each motion seat.
- Seat and back cushions are fixed to the frame.
- With Leather Side (the sectional pieces come with leather sides)
- Metal Frame
- Feet will be in a bag inside the package and requires assembling.
- Closed base modules with hidden metal anti-slip and anti-scratch feet (4cm height)
- Open base modules with arch shaped anti-scratch feet in die-cast metal available in 3 finishes: 74 graphite gray rough, 77 glossy chrome and 45 glossy black

**NOTES**

---

- Feet height 20,0 cm



■ Vers. 135



■ Vers. 135





■ Vers. 066

## SCHEMATICS

---

83cm / 33"  
  
43cm / 17"

83cm / 33"  
  
**066**





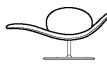

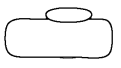
71cm / 28"    118cm / 46"  
  
**066**

85cm / 33"  
  
39cm / 15"

85cm / 33"  
  
**135**

80cm / 31"    175cm / 69"  
  
**135**

TECHNICAL INFORMATION

	<b>COVERING</b>	Leather <input checked="" type="checkbox"/>	Soft Cover <input checked="" type="checkbox"/>				
	<b>FILLING</b>	Arms	<input type="checkbox"/> Fiber <input checked="" type="checkbox"/> Foam <input type="checkbox"/> Feather/Fiber Mix <input type="checkbox"/> Feather	Seat cushion	<input type="checkbox"/> Fiber <input checked="" type="checkbox"/> Foam <input type="checkbox"/> Feather/Fiber Mix <input type="checkbox"/> Feather	Back cushion	<input type="checkbox"/> Fiber <input checked="" type="checkbox"/> Foam <input type="checkbox"/> Feather/Fiber Mix <input type="checkbox"/> Feather
	<b>COMFORT</b>	Standard Comfort <input checked="" type="checkbox"/>	Firm Comfort <input type="checkbox"/>				
	<b>FUNCTION</b>	Bed <input type="checkbox"/>	Electric motion <input type="checkbox"/>	Motion <input type="checkbox"/>	Recliner <input type="checkbox"/>	Sliding <input type="checkbox"/>	
	<b>VISUAL APPEARANCE*</b>	Low <input checked="" type="checkbox"/>	Medium <input type="checkbox"/>	High <input type="checkbox"/>			
	<b>LEGS</b>	Wood <input type="checkbox"/>	Metal <input checked="" type="checkbox"/>	Plastic <input type="checkbox"/>	Castors <input type="checkbox"/>	Upholstered <input type="checkbox"/>	

VISUAL APPEARANCE

The product may reveal various wrinkles due to the combination of Elasticity of the covering, characteristics of the interior construction and the design of the product.



Products with Visual Appearance listed as High or Medium would require higher degree of care, where seats and back cushions may require fluffing and plumping more often than Products with Visual Appearance listed as Low.

NOTES

- Form obtained with rigid structural polyurethane
- Available with the following fabrics: Lamezia, Rizzoli, Magenta, Tornabuoni, Botteghe, Lagrange, Santandrea, Castiglione, Condotti, Retro' and Laguna.
- Model is not available with article Misterbianco (cat. 30).
- Version 066 available with tray black ashwood
- Tight Seat Cushion (the seat cushions of the models are fixed to the frame)
- Tight Back Cushion (the back cushions of the models are fixed to the frame)
- Metal Frame
- Feet will be in a bag inside the package and requires assembling.
- Metal base available in glossy black metal (45)
- Feet height 32,0 cm

NOTES

---



■ Vers. 655



■ Vers. 655



■ Vers. 003+003

SCHEMATICS

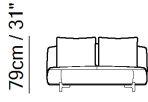
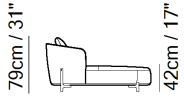

655

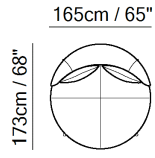

655

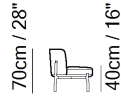



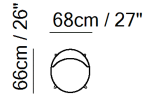

003



003

TECHNICAL INFORMATION

	<b>COVERING</b>	Leather <input checked="" type="checkbox"/>	Soft Cover <input checked="" type="checkbox"/>				
	<b>FILLING</b>	Arms	<input type="checkbox"/> Fiber <input checked="" type="checkbox"/> Foam <input type="checkbox"/> Feather/Fiber Mix <input type="checkbox"/> Feather	Seat cushion	<input type="checkbox"/> Fiber <input checked="" type="checkbox"/> Foam <input type="checkbox"/> Feather/Fiber Mix <input type="checkbox"/> Feather	Back cushion	<input type="checkbox"/> Fiber <input checked="" type="checkbox"/> Foam <input type="checkbox"/> Feather/Fiber Mix <input type="checkbox"/> Feather
	<b>COMFORT</b>	Standard Comfort <input checked="" type="checkbox"/>	Firm Comfort <input type="checkbox"/>				
	<b>FUNCTION</b>	Bed <input type="checkbox"/>	Electric motion <input type="checkbox"/>	Motion <input type="checkbox"/>	Recliner <input type="checkbox"/>	Sliding <input type="checkbox"/>	
	<b>LEGS</b>	Wood <input checked="" type="checkbox"/>	Plastic <input type="checkbox"/>	Metal <input type="checkbox"/>	Upholstered <input type="checkbox"/>	Castors <input type="checkbox"/>	

NOTES

- Designed by Bernhardt & Vella.
- An oasis of pure relaxation, a perfect blend of classical and contemporary styles. With its simple lines, Amalia steals the limelight in any living room or sleeping area.
- A sofa with rounded lines, but also an inviting dormouse. Amalia is also available without armrests.
- Its original rounded backrest embraces two large cushions filled with the finest-quality breathable, anti-allergy materials, ensuring lasting good looks and support.
- Model is not available with article Misterbianco (cat. 30).
- Tight Seat Cushion (the seat cushions of the models are fixed to the frame)
- Tight Back Cushion (the back cushions of the models are fixed to the frame)
- Wood/Metal Frame
- Feet will be in a bag inside the package and requires assembling.
- Front feet are slightly higher in respect to rear.
- Feet available in wooden finishings 32 (Smoked Oak) / 39 (European Walnut)
- Feet height 11,0/26,0 cm

**NOTES**

---



■ Vers. 003



■ Vers. 003







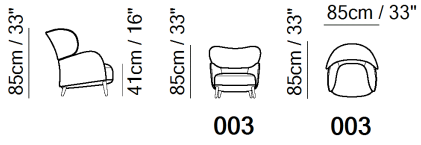

■ Vers. 003

SCHEMATICS

---



TECHNICAL INFORMATION

	<b>COVERING</b>	Leather <input checked="" type="checkbox"/>	Soft Cover <input checked="" type="checkbox"/>				
	<b>FILLING</b>	Arms	<input type="checkbox"/> Fiber <input checked="" type="checkbox"/> Foam <input type="checkbox"/> Feather/Fiber Mix <input type="checkbox"/> Feather	Seat cushion	<input type="checkbox"/> Fiber <input checked="" type="checkbox"/> Foam <input type="checkbox"/> Feather/Fiber Mix <input type="checkbox"/> Feather	Back cushion	<input type="checkbox"/> Fiber <input checked="" type="checkbox"/> Foam <input type="checkbox"/> Feather/Fiber Mix <input type="checkbox"/> Feather
	<b>COMFORT</b>	Standard Comfort <input checked="" type="checkbox"/>	Firm Comfort <input type="checkbox"/>				
	<b>FUNCTION</b>	Bed <input type="checkbox"/>	Electric motion <input type="checkbox"/>	Motion <input type="checkbox"/>	Recliner <input type="checkbox"/>	Sliding <input type="checkbox"/>	
	<b>VISUAL APPEARANCE*</b>	Low <input type="checkbox"/>	Medium <input type="checkbox"/>	High <input checked="" type="checkbox"/>			
	<b>LEGS</b>	Wood <input checked="" type="checkbox"/>	Metal <input type="checkbox"/>	Plastic <input type="checkbox"/>	Castors <input type="checkbox"/>	Upholstered <input type="checkbox"/>	

VISUAL APPEARANCE

The product may reveal various wrinkles due to the combination of Elasticity of the covering, characteristics of the interior construction and the design of the product.



Products with Visual Appearance listed as High or Medium would require higher degree of care, where seats and back cushions may require fluffing and plumping more often than Products with Visual Appearance listed as Low.

NOTES

- Designed by Claudio Bellini.
- Date of launch: 2019.
- The 50s make a stylish come-back in the Blossom armchair project. The highly inviting design alludes to the profile of a bud and generous shapes confer a distinct visual comfort which is confirmed by the quality of its upholstery.
- Model is not available with fabric article Laguna.
- Seat and back cushions are fixed to the frame.
- Feet will be in a bag inside the package and requires assembling.
- Front feet are slightly higher in respect to rear.
- Feet available in wood finishings 09 (Walnut) / 18 (Wengè)
- Feet height 20,0/15,0 cm

NOTES

---



■ Vers. 009



■ Vers. 005



■ Vers. 003

SCHEMATICS



009

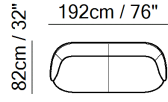

009

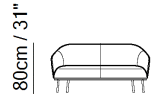

005

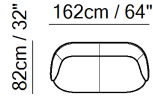

005



003





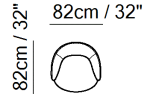

003



003

TECHNICAL INFORMATION

	<b>COVERING</b>	Leather <input checked="" type="checkbox"/>	Soft Cover <input checked="" type="checkbox"/>			
	<b>FILLING</b>	Arms <input type="checkbox"/> Fiber <input checked="" type="checkbox"/> Foam <input type="checkbox"/> Feather/Fiber Mix <input type="checkbox"/> Feather	Seat cushion <input type="checkbox"/> Fiber <input checked="" type="checkbox"/> Foam <input type="checkbox"/> Feather/Fiber Mix <input type="checkbox"/> Feather	Back cushion <input type="checkbox"/> Fiber <input checked="" type="checkbox"/> Foam <input type="checkbox"/> Feather/Fiber Mix <input type="checkbox"/> Feather		
	<b>COMFORT</b>	Standard Comfort <input checked="" type="checkbox"/>	Firm Comfort <input type="checkbox"/>			
	<b>FUNCTION</b>	Bed <input type="checkbox"/>	Electric motion <input type="checkbox"/>	Motion <input type="checkbox"/>	Recliner <input type="checkbox"/>	Sliding <input type="checkbox"/>
	<b>LEGS</b>	Wood <input type="checkbox"/>	Plastic <input type="checkbox"/>	Metal <input checked="" type="checkbox"/>	Upholstered <input type="checkbox"/>	Castors <input type="checkbox"/>

NOTES

- Designed by Claudio Bellini.
- A welcoming refuge which adds style and originality to your interiors. Botanic reinterprets the style of the 50s, harmonizing it in an open-based project with metal feet, clear features of later trends. In fabric or leather, it generates an immediate sense of hospitality, thanks to its soft and enveloping forms.
- The decorative piping underlines the shape of the sofa and emphasizes its mid-century design.
- Model is not available with article Misterbianco (cat. 30).
- Tight Seat Cushion (the seat cushions of the models are fixed to the frame)
- Tight Back Cushion (the back cushions of the models are fixed to the frame)
- Internal wooden frame.
- Front feet are slightly higher in respect to rear.
- Feet available in metal finishing 79 (Matte Black)
- Feet height 22,0/20,0 cm

NOTES

---



■ Vers. 009



■ Vers. 088



■ Vers. 016+032+073



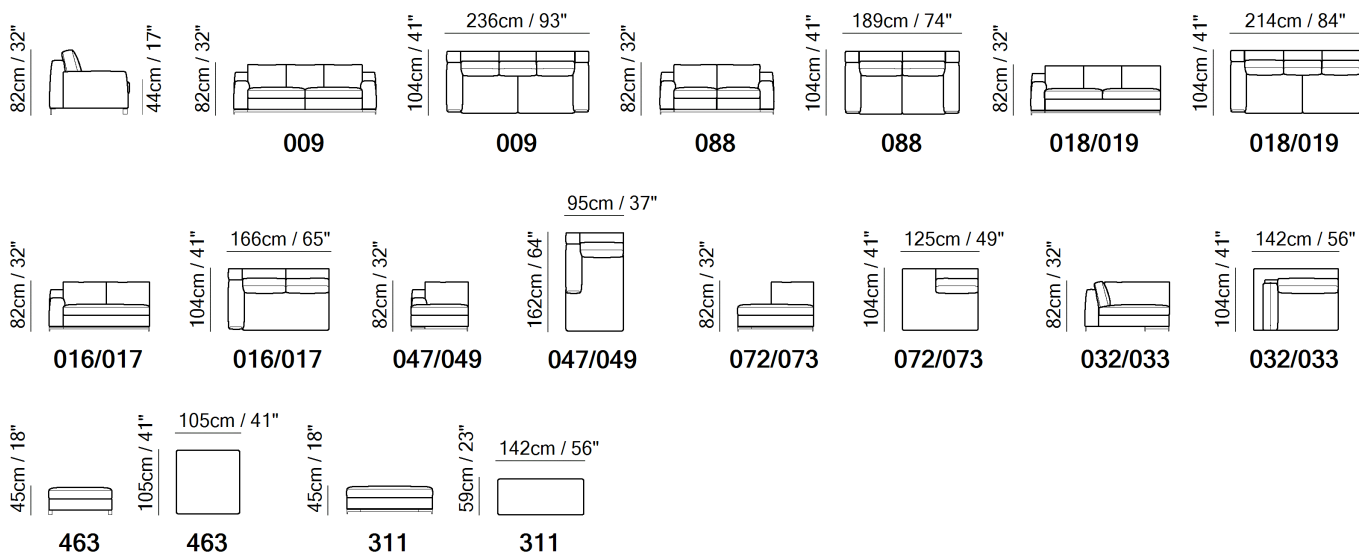

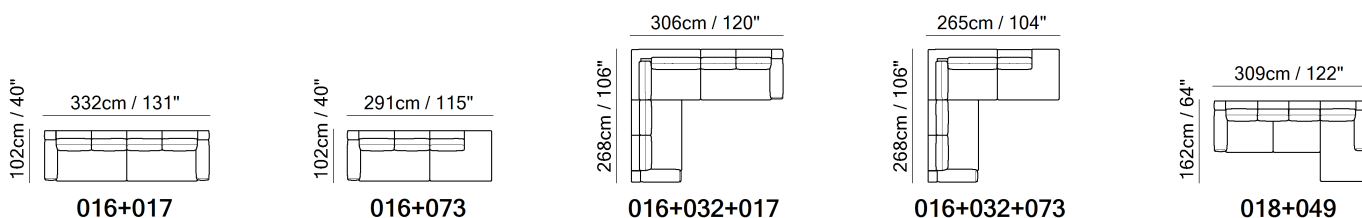

## SCHEMATICS



## COMPOSITION EXAMPLES



TECHNICAL INFORMATION

	<b>COVERING</b>	Leather <input checked="" type="checkbox"/>	Soft Cover <input checked="" type="checkbox"/>			
	<b>FILLING</b>	Arms <input type="checkbox"/> Fiber <input checked="" type="checkbox"/> Foam <input type="checkbox"/> Feather/Fiber Mix <input type="checkbox"/> Feather	Seat cushion <input type="checkbox"/> Fiber <input checked="" type="checkbox"/> Foam <input type="checkbox"/> Feather/Fiber Mix <input type="checkbox"/> Feather	Back cushion <input checked="" type="checkbox"/> Fiber <input type="checkbox"/> Foam <input type="checkbox"/> Feather/Fiber Mix <input type="checkbox"/> Feather		
	<b>COMFORT</b>	Standard Comfort <input checked="" type="checkbox"/>	Firm Comfort <input type="checkbox"/>			
	<b>FUNCTION</b>	Bed <input type="checkbox"/>	Electric motion <input type="checkbox"/>	Motion <input type="checkbox"/>	Recliner <input type="checkbox"/>	Sliding <input type="checkbox"/>
	<b>VISUAL APPEARANCE*</b>	Low <input type="checkbox"/>	Medium <input checked="" type="checkbox"/>	High <input type="checkbox"/>		
	<b>LEGS</b>	Wood <input checked="" type="checkbox"/>	Metal <input type="checkbox"/>	Plastic <input type="checkbox"/>	Castors <input type="checkbox"/>	Upholstered <input type="checkbox"/>

VISUAL APPEARANCE

The product may reveal various wrinkles due to the combination of Elasticity of the covering, characteristics of the interior construction and the design of the product.



Products with Visual Appearance listed as High or Medium would require higher degree of care, where seats and back cushions may require fluffing and plumping more often than Products with Visual Appearance listed as Low.

NOTES

- Designed by Maurizio Manzoni.
- The highly versatile LEAF sofa comes into its own in more structured compositions. Comfort and linearity provide an ideal blend for everyday moments of pleasure and friendship.
- Model is not available with article Misterbianco (cat. 30).
- To allow modularity, the single elements can be put together thanks to the rubber stops under the legs.
- Comfort >> The mix of padding in polyurethane and Climalight (special latest-generation silicone microfibre) guarantees a look and support that does not change over time.
- Tight Seat Cushion (the seat cushions of the models are fixed to the frame)
- Loose Back Cushion (the back cushions of the model are not fixed to the frame)
- Internal wooden frame.
- Feet will be in a bag inside the package and requires assembling.
- Solid wood base black ashwood (FT51) combined with metal feet in glossy black (FT71)
- Feet height 10,5 cm

NOTES

---



■ Vers. 272+274



■ Vers. 272+489+291+274



■ Vers. 450+452



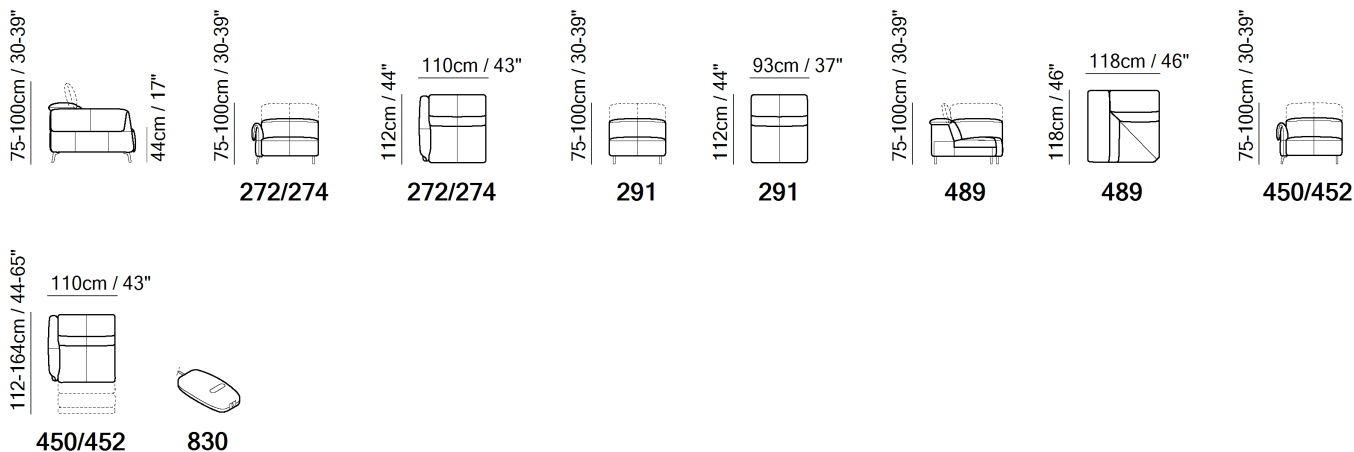

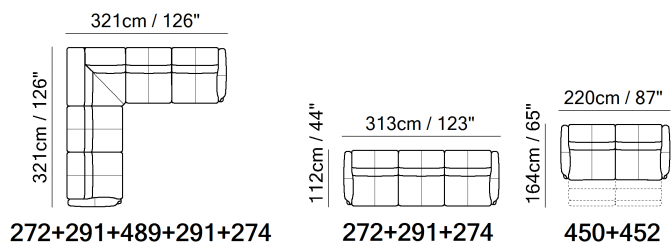

## SCHEMATICS



## COMPOSITION EXAMPLES



TECHNICAL INFORMATION

	<b>COVERING</b>	Leather <input checked="" type="checkbox"/>	Soft Cover <input checked="" type="checkbox"/>			
	<b>FILLING</b>	Arms <input type="checkbox"/> Fiber <input checked="" type="checkbox"/> Foam <input type="checkbox"/> Feather/Fiber Mix <input type="checkbox"/> Feather	Seat cushion <input type="checkbox"/> Fiber <input checked="" type="checkbox"/> Foam <input type="checkbox"/> Feather/Fiber Mix <input type="checkbox"/> Feather	Back cushion <input type="checkbox"/> Fiber <input checked="" type="checkbox"/> Foam <input type="checkbox"/> Feather/Fiber Mix <input type="checkbox"/> Feather		
	<b>COMFORT</b>	Standard Comfort <input checked="" type="checkbox"/>	Firm Comfort <input checked="" type="checkbox"/>			
	<b>FUNCTION</b>	Bed <input type="checkbox"/>	Electric motion <input checked="" type="checkbox"/>	Motion <input type="checkbox"/>	Recliner <input type="checkbox"/>	Sliding <input type="checkbox"/>
	<b>VISUAL APPEARANCE*</b>	Low <input type="checkbox"/>	Medium <input type="checkbox"/>	High <input checked="" type="checkbox"/>		
	<b>LEGS</b>	Wood <input type="checkbox"/>	Plastic <input type="checkbox"/>	Metal <input checked="" type="checkbox"/>	Upholstered <input type="checkbox"/>	Castors <input type="checkbox"/>

VISUAL APPEARANCE

The product may reveal various wrinkles due to the combination of Elasticity of the covering, characteristics of the interior construction and the design of the product.



Products with Visual Appearance listed as High or Medium would require higher degree of care, where seats and back cushions may require fluffing and plumping more often than Products with Visual Appearance listed as Low.

NOTES

- Designed by Claudio Bellini.
- Date of launch: 2019.
- With its abundant soft profile, SEAGULL exudes comfort, an impression which is further underlined by its electric relaxation mechanisms and adjustable headrest.
- Model is not available with article Misterbianco (cat. 30).
- The model has external soft touch buttons on the arm to activate the mechanism.
- Thanks to ZeroWall mechanism, seat and back cushions can be reclined at a great length without moving sofa away from the wall.
- Model has power combined headrest. ATTENTION! The headrest opens first followed by the footrest; then the headrest has one final extra rotation for comfortable TV watching position.
- A battery pack can be ordered with its own version code 830. For order entry please use XX for category and XXX for cover code. In order to optimize the duration of the battery, it is suggested to order one per each motion seat.
- Seat and back cushions are fixed to the frame.
- No Leather/Fabric Side (the sectional pieces have the side covered with lining and not leather nor fabric)
- Internal wooden frame.
- Feet will be in a bag inside the package and requires assembling.

## NOTES

---

- Feet available in metal finishing 78 (Black Chrome)
- Feet height 13,0 cm



■ Vers. 064

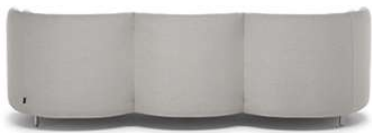

■ Vers. 064







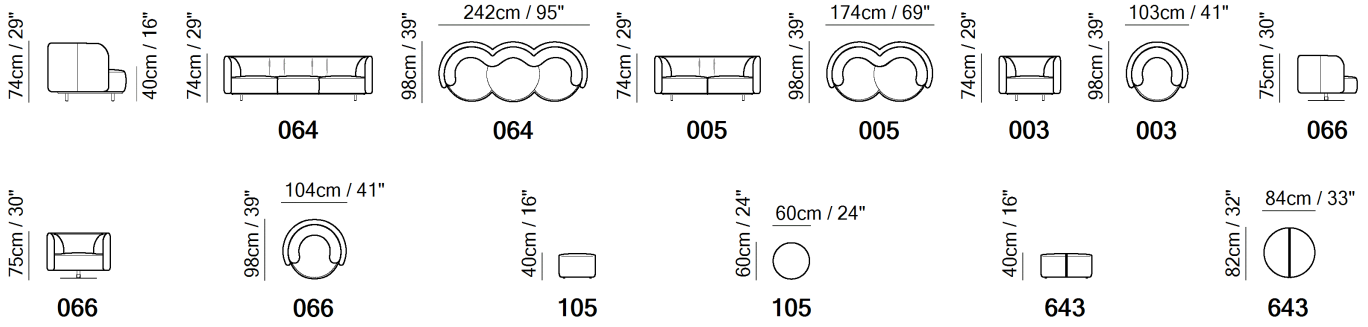

■ Vers. 005+003

SCHEMATICS



TECHNICAL INFORMATION

	<b>COVERING</b>	Leather <input checked="" type="checkbox"/>	Soft Cover <input checked="" type="checkbox"/>			
	<b>FILLING</b>	Arms <input type="checkbox"/> Fiber <input checked="" type="checkbox"/> Foam <input type="checkbox"/> Feather/Fiber Mix <input type="checkbox"/> Feather	Seat cushion <input type="checkbox"/> Fiber <input checked="" type="checkbox"/> Foam <input type="checkbox"/> Feather/Fiber Mix <input type="checkbox"/> Feather	Back cushion <input type="checkbox"/> Fiber <input checked="" type="checkbox"/> Foam <input type="checkbox"/> Feather/Fiber Mix <input type="checkbox"/> Feather		
	<b>COMFORT</b>	Standard Comfort <input checked="" type="checkbox"/>	Firm Comfort <input type="checkbox"/>			
	<b>FUNCTION</b>	Bed <input type="checkbox"/>	Electric motion <input type="checkbox"/>	Motion <input type="checkbox"/>	Recliner <input type="checkbox"/>	Sliding <input type="checkbox"/>
	<b>VISUAL APPEARANCE*</b>	Low <input type="checkbox"/>	Medium <input checked="" type="checkbox"/>	High <input type="checkbox"/>		
	<b>LEGS</b>	Wood <input type="checkbox"/>	Metal <input checked="" type="checkbox"/>	Plastic <input type="checkbox"/>	Castors <input type="checkbox"/>	Upholstered <input type="checkbox"/>

VISUAL APPEARANCE

The product may reveal various wrinkles due to the combination of Elasticity of the covering, characteristics of the interior construction and the design of the product.



Products with Visual Appearance listed as High or Medium would require higher degree of care, where seats and back cushions may require fluffing and plumping more often than Products with Visual Appearance listed as Low.

NOTES

- Designed by Nika Zupanc.
- Magazine Rack Voyage (T845) is a unique element that can be positioned on the ground next to the seat, or integrated into the Pouf and Ottoman versions of the 3201 Wave model.
- Model is not available with article Misterbianco (cat. 30).
- Tight Seat Cushion (the seat cushions of the models are fixed to the frame)
- Tight Back Cushion (the back cushions of the models are fixed to the frame)
- Internal wooden frame.
- Feet will be in a bag inside the package and requires assembling.
- Feet available in metal finishing 88 (Light Gold)
- Feet height 11,0 cm

NOTES

---



■ Vers. 780+745+049



■ Vers. 780+745



■ Vers. 783+785





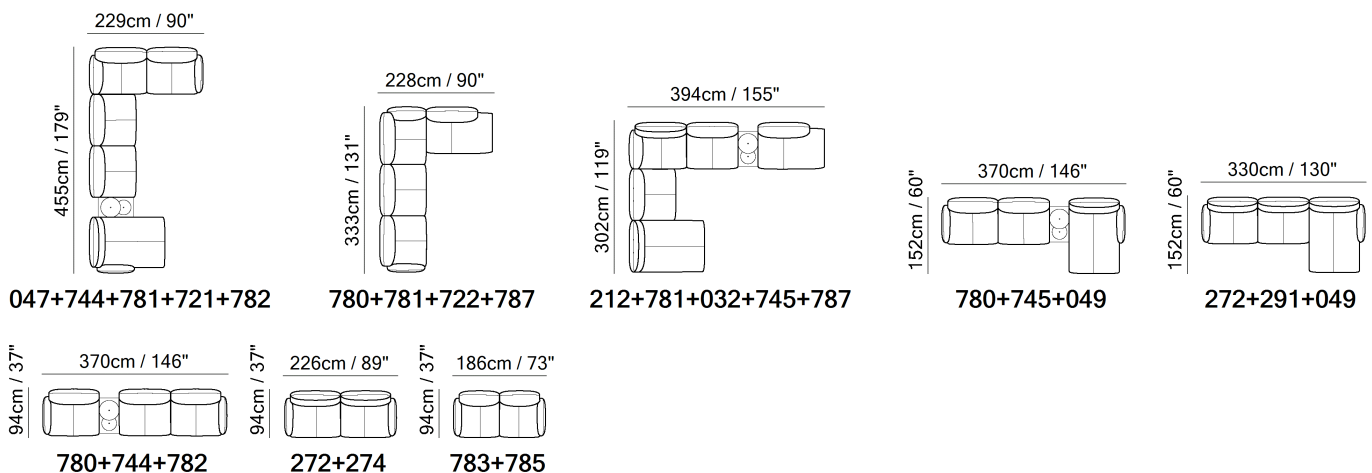

SCHEMATICS



COMPOSITION EXAMPLES



TECHNICAL INFORMATION

	<b>COVERING</b>	Leather <input checked="" type="checkbox"/>	Soft Cover <input checked="" type="checkbox"/>			
	<b>FILLING</b>	Arms <input type="checkbox"/> Fiber <input checked="" type="checkbox"/> Foam <input type="checkbox"/> Feather/Fiber Mix <input type="checkbox"/> Feather	Seat cushion <input type="checkbox"/> Fiber <input checked="" type="checkbox"/> Foam <input type="checkbox"/> Feather/Fiber Mix <input type="checkbox"/> Feather	Back cushion <input type="checkbox"/> Fiber <input checked="" type="checkbox"/> Foam <input type="checkbox"/> Feather/Fiber Mix <input type="checkbox"/> Feather		
	<b>COMFORT</b>	Standard Comfort <input checked="" type="checkbox"/>	Firm Comfort <input type="checkbox"/>			
	<b>FUNCTION</b>	Bed <input type="checkbox"/>	Electric motion <input type="checkbox"/>	Motion <input type="checkbox"/>	Recliner <input type="checkbox"/>	Sliding <input type="checkbox"/>
	<b>VISUAL APPEARANCE*</b>	Low <input checked="" type="checkbox"/>	Medium <input type="checkbox"/>	High <input type="checkbox"/>		
	<b>LEGS</b>	Wood <input type="checkbox"/>	Plastic <input type="checkbox"/>	Metal <input checked="" type="checkbox"/>	Upholstered <input type="checkbox"/>	Castors <input type="checkbox"/>

VISUAL APPEARANCE

The product may reveal various wrinkles due to the combination of Elasticity of the covering, characteristics of the interior construction and the design of the product.



Products with Visual Appearance listed as High or Medium would require higher degree of care, where seats and back cushions may require fluffing and plumping more often than Products with Visual Appearance listed as Low.

NOTES

- Designed by Claudio Bellini.
- Heights and volumes make Pablo the icon of contemporary furnishing.
- PABLO is the first sofa in the Natuzzi Italia collection with high back and low back modules that can be mixed together to create contemporary configurations with different comfort. Modules with high back for those who want to completely relax while also supporting the garment, or modules with low back for a cooler design.
- To allow modularity, the single elements can be put together thanks to the rubber stops under the legs.
- The 576-578 versions have a shelf integrated into the seat via pin. It is made of gray matt lacquered wood and acts as a comfortable and functional support surface.
- The 744-745 versions, in addition to the shelf, are completed by a table with extra white tempered glass top with a polished edge profile. The stem that holds the glass top is in pewter colored metal like the feet and the details on the armrest.
- Feet available in metal finishing 80 (pewter)

NOTES

---



■ Vers. 009+089+089



■ Vers. 009+089+089



■ Vers. 029+291+200+019+089



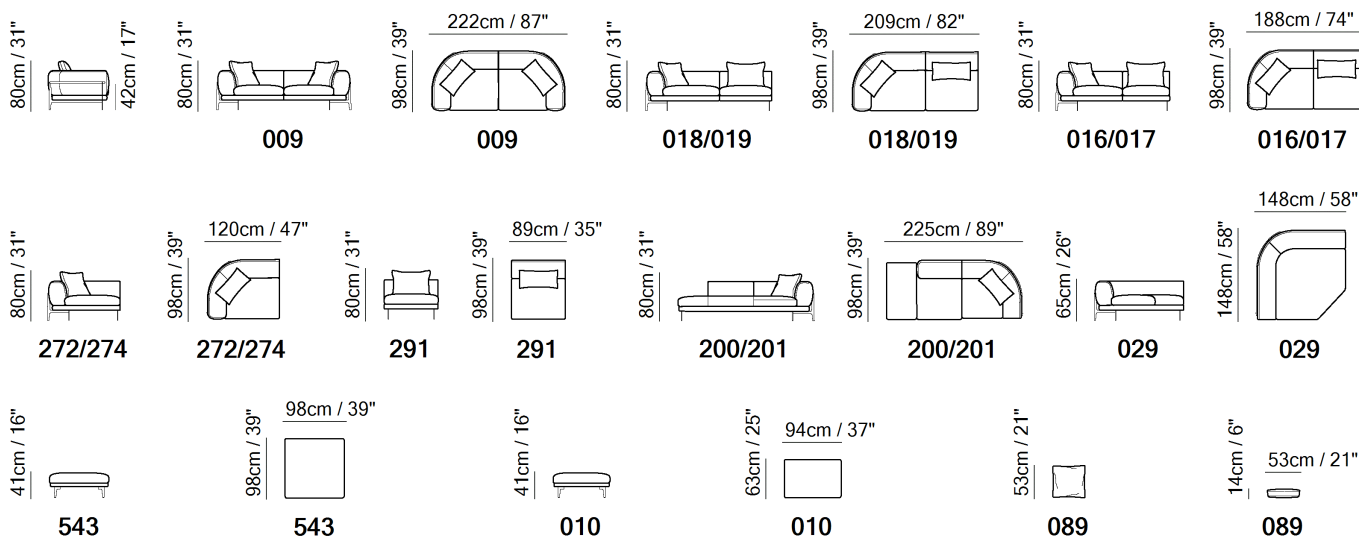

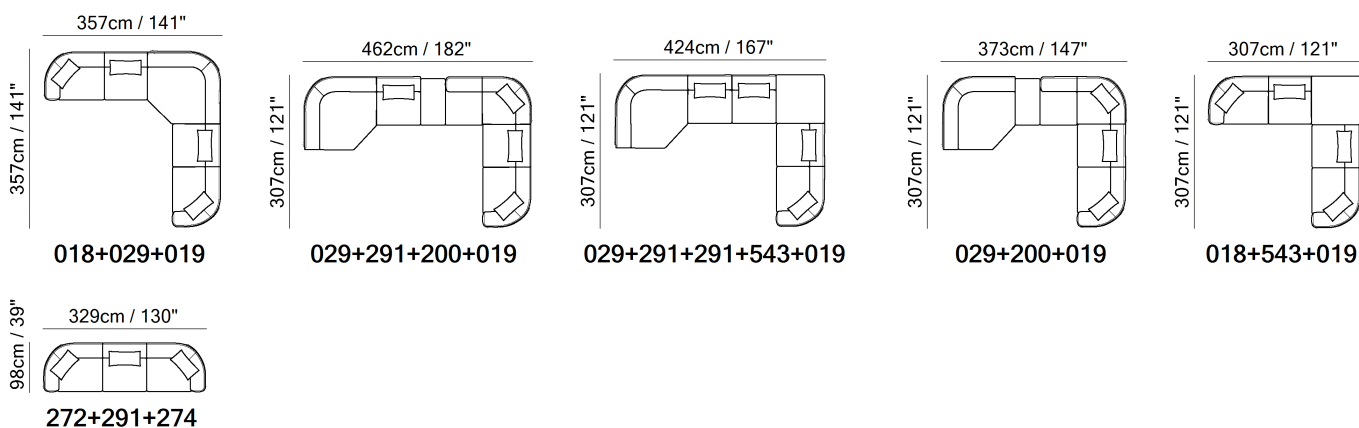

## SCHEMATICS



## COMPOSITION EXAMPLES



TECHNICAL INFORMATION

	<b>COVERING</b>	Leather <input checked="" type="checkbox"/>	Soft Cover <input checked="" type="checkbox"/>				
	<b>FILLING</b>	Arms	<input type="checkbox"/> Fiber <input checked="" type="checkbox"/> Foam <input type="checkbox"/> Feather/Fiber Mix <input type="checkbox"/> Feather	Seat cushion	<input type="checkbox"/> Fiber <input checked="" type="checkbox"/> Foam <input type="checkbox"/> Feather/Fiber Mix <input type="checkbox"/> Feather	Back cushion	<input type="checkbox"/> Fiber <input checked="" type="checkbox"/> Foam <input type="checkbox"/> Feather/Fiber Mix <input type="checkbox"/> Feather
	<b>COMFORT</b>	Standard Comfort <input checked="" type="checkbox"/>	Firm Comfort <input type="checkbox"/>				
	<b>FUNCTION</b>	Bed <input type="checkbox"/>	Electric motion <input type="checkbox"/>	Motion <input type="checkbox"/>	Recliner <input type="checkbox"/>	Sliding <input type="checkbox"/>	
	<b>VISUAL APPEARANCE*</b>	Low <input checked="" type="checkbox"/>	Medium <input type="checkbox"/>	High <input type="checkbox"/>			
	<b>LEGS</b>	Wood <input type="checkbox"/>	Metal <input checked="" type="checkbox"/>	Plastic <input type="checkbox"/>	Castors <input type="checkbox"/>	Upholstered <input type="checkbox"/>	

VISUAL APPEARANCE

The product may reveal various wrinkles due to the combination of Elasticity of the covering, characteristics of the interior construction and the design of the product.



Products with Visual Appearance listed as High or Medium would require higher degree of care, where seats and back cushions may require fluffing and plumping more often than Products with Visual Appearance listed as Low.

NOTES

- Designed by Maurizio Manzoni.
- Date of launch: 2020.
- OBLO' is the safe window from which to observe what is beyond the glass. A robust frame to rely on, and rounded shapes from which to be pampered.
- Rounded and fluid shapes for the armrest and back embellished with a metal tubing that surrounds it as if it were a belt that emphasizes the softness and roundness of the sinuous body. In addition to being a strong design element, this tubular features becomes a foot by grafting onto laser-cut steel plates.
- Available in leather or fabric.
- To allow modularity, the single elements can be put together thanks to the rubber stops under the legs.
- 200/201 versions have a non-upholstered side panel.
- Comfort >> The mix of padding in polyurethane and Climalight (special latest-generation silicone microfibre) guarantees a look and support that does not change over time.
- Feet and base in 87 (matt black metal with brushed brass tips)

NOTES

---



■ Vers. 000+221



■ Vers. 000+001+032+291+010



■ Vers. 135



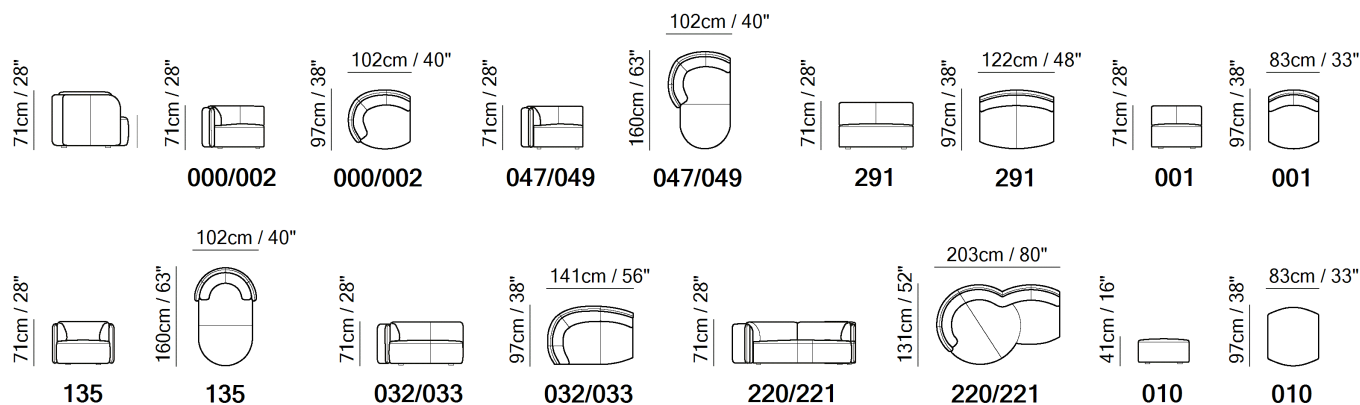

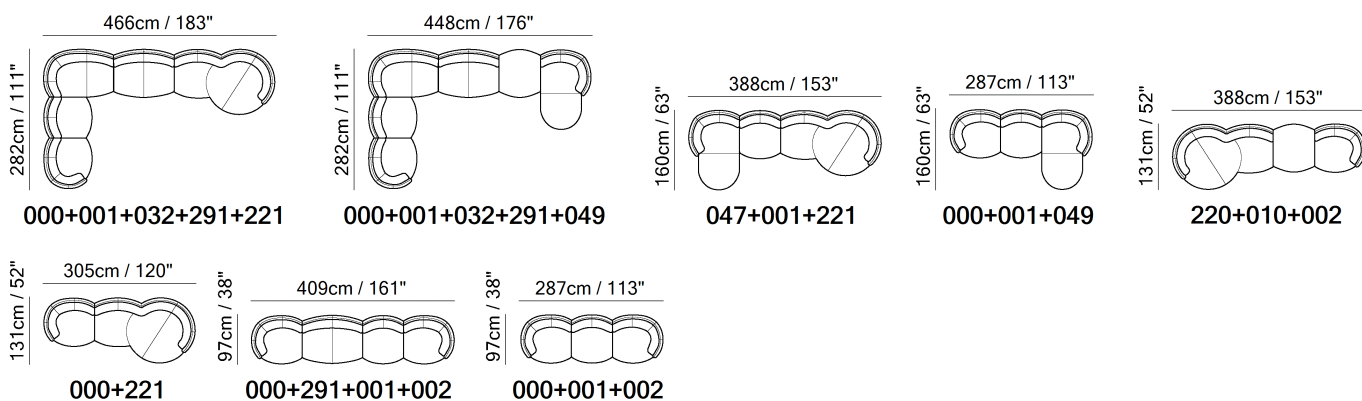

SCHEMATICS



COMPOSITION EXAMPLES



TECHNICAL INFORMATION

	<b>COVERING</b>	Leather <input checked="" type="checkbox"/>	Soft Cover <input checked="" type="checkbox"/>				
	<b>FILLING</b>	Arms	<input type="checkbox"/> Fiber <input checked="" type="checkbox"/> Foam <input type="checkbox"/> Feather/Fiber Mix <input type="checkbox"/> Feather	Seat cushion	<input type="checkbox"/> Fiber <input checked="" type="checkbox"/> Foam <input type="checkbox"/> Feather/Fiber Mix <input type="checkbox"/> Feather	Back cushion	<input type="checkbox"/> Fiber <input checked="" type="checkbox"/> Foam <input type="checkbox"/> Feather/Fiber Mix <input type="checkbox"/> Feather
	<b>COMFORT</b>	Standard Comfort <input checked="" type="checkbox"/>	Firm Comfort <input type="checkbox"/>				
	<b>FUNCTION</b>	Bed <input type="checkbox"/>	Electric motion <input type="checkbox"/>	Motion <input type="checkbox"/>	Recliner <input type="checkbox"/>	Sliding <input type="checkbox"/>	
	<b>VISUAL APPEARANCE*</b>	Low <input type="checkbox"/>	Medium <input checked="" type="checkbox"/>	High <input type="checkbox"/>			
	<b>LEGS</b>	Wood <input type="checkbox"/>	Plastic <input type="checkbox"/>	Metal <input type="checkbox"/>	Upholstered <input type="checkbox"/>	Castors <input type="checkbox"/>	

VISUAL APPEARANCE

The product may reveal various wrinkles due to the combination of Elasticity of the covering, characteristics of the interior construction and the design of the product.



Products with Visual Appearance listed as High or Medium would require higher degree of care, where seats and back cushions may require fluffing and plumping more often than Products with Visual Appearance listed as Low.

NOTES

- Designed by Nika Zupanc.
- Date of launch: 2020.
- Model is not available with article Misterbianco (cat. 30).
- Seat cushion includes a layer of memory foam, a pressure-sensitive soft polyurethane, that recovers its form completely thus giving great comfort.
- Upholstered sofa sides with hidden and removable hooks
- Anti-scratch and non-slip hidden feet.

NOTES

---



■ Vers. 009



■ Vers. 009







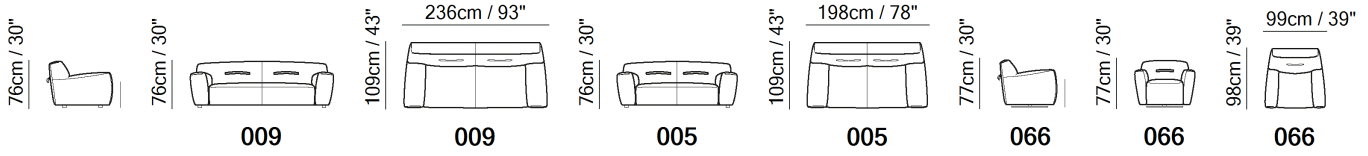

■ Vers. 066

SCHEMATICS



TECHNICAL INFORMATION

	<b>COVERING</b>	Leather <input checked="" type="checkbox"/>	Soft Cover <input checked="" type="checkbox"/>				
	<b>FILLING</b>	Arms	<input type="checkbox"/> Fiber <input checked="" type="checkbox"/> Foam <input type="checkbox"/> Feather/Fiber Mix <input type="checkbox"/> Feather	Seat cushion	<input type="checkbox"/> Fiber <input checked="" type="checkbox"/> Foam <input type="checkbox"/> Feather/Fiber Mix <input type="checkbox"/> Feather	Back cushion	<input type="checkbox"/> Fiber <input checked="" type="checkbox"/> Foam <input type="checkbox"/> Feather/Fiber Mix <input type="checkbox"/> Feather
	<b>COMFORT</b>	Standard Comfort <input checked="" type="checkbox"/>	Firm Comfort <input type="checkbox"/>				
	<b>FUNCTION</b>	Bed <input type="checkbox"/>	Electric motion <input type="checkbox"/>	Motion <input type="checkbox"/>	Recliner <input type="checkbox"/>	Sliding <input type="checkbox"/>	
	<b>VISUAL APPEARANCE*</b>	Low <input type="checkbox"/>	Medium <input type="checkbox"/>	High <input checked="" type="checkbox"/>			
	<b>LEGS</b>	Wood <input type="checkbox"/>	Metal <input checked="" type="checkbox"/>	Plastic <input type="checkbox"/>	Castors <input type="checkbox"/>	Upholstered <input type="checkbox"/>	

VISUAL APPEARANCE

The product may reveal various wrinkles due to the combination of Elasticity of the covering, characteristics of the interior construction and the design of the product.



Products with Visual Appearance listed as High or Medium would require higher degree of care, where seats and back cushions may require fluffing and plumping more often than Products with Visual Appearance listed as Low.

NOTES

- Designed by Paola Navone.
- The peculiarity of ARGO is its design with soft and rounded shapes. It is an invitation to enjoy life by lying completely in its softness.
- Model is not available with article Misterbianco (cat. 30).
- Comfort >> The mix of padding in polyurethane and Climalight (special latest-generation silicone microfibre) guarantees a look and support that does not change over time.
- Tight Seat Cushion (the seat cushions of the models are fixed to the frame)
- Tight Back Cushion (the back cushions of the models are fixed to the frame)
- Feet will be in a bag inside the package and requires assembling.
- Feet available in metal finishing 79 (Matte Black)
- Feet height 5,0 cm

NOTES

---



■ Vers. 272+202+274



■ Vers. 272+202+274



■ Vers. 272+274



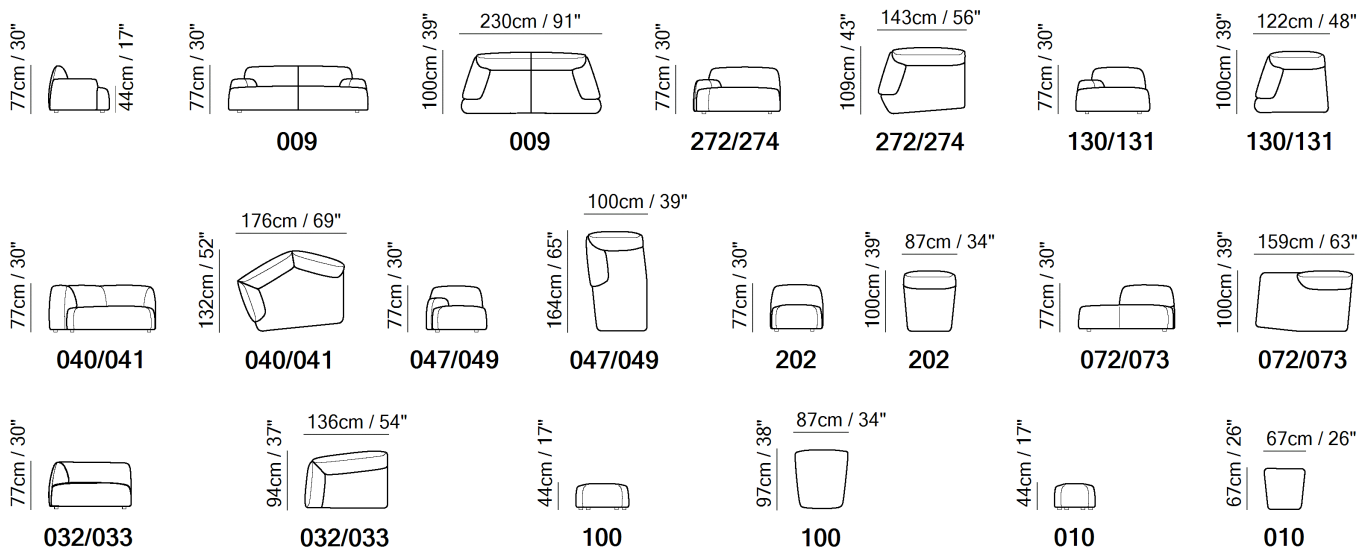

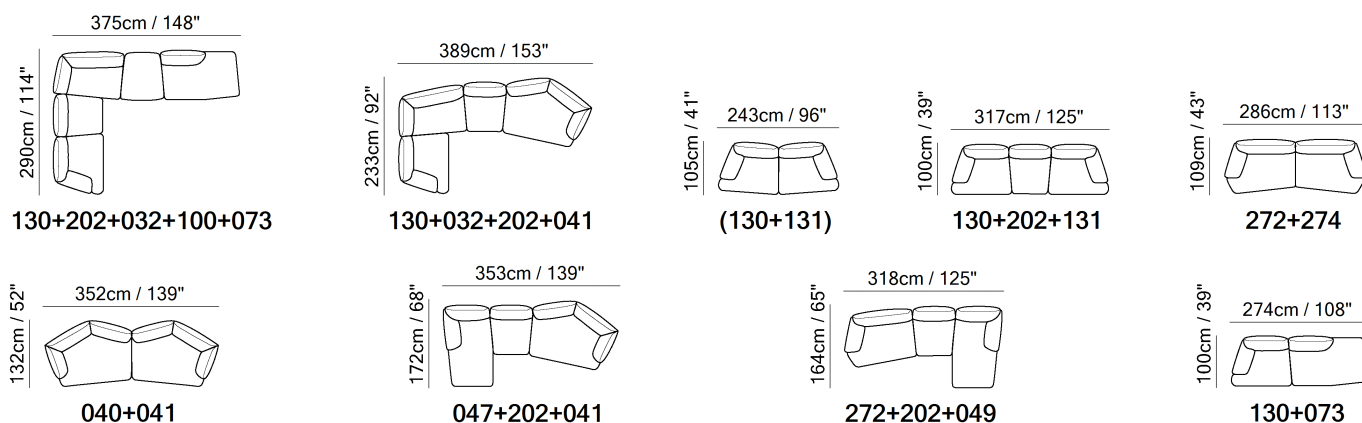

## SCHEMATICS



## COMPOSITION EXAMPLES



TECHNICAL INFORMATION

	<b>COVERING</b>	Leather <input checked="" type="checkbox"/>	Soft Cover <input checked="" type="checkbox"/>				
	<b>FILLING</b>	Arms	<input type="checkbox"/> Fiber <input checked="" type="checkbox"/> Foam <input type="checkbox"/> Feather/Fiber Mix <input type="checkbox"/> Feather	Seat cushion	<input type="checkbox"/> Fiber <input checked="" type="checkbox"/> Foam <input type="checkbox"/> Feather/Fiber Mix <input type="checkbox"/> Feather	Back cushion	<input type="checkbox"/> Fiber <input checked="" type="checkbox"/> Foam <input type="checkbox"/> Feather/Fiber Mix <input type="checkbox"/> Feather
	<b>COMFORT</b>	Standard Comfort <input checked="" type="checkbox"/>	Firm Comfort <input type="checkbox"/>				
	<b>FUNCTION</b>	Bed <input type="checkbox"/>	Electric motion <input type="checkbox"/>	Motion <input type="checkbox"/>	Recliner <input type="checkbox"/>	Sliding <input type="checkbox"/>	
	<b>VISUAL APPEARANCE*</b>	Low <input checked="" type="checkbox"/>	Medium <input type="checkbox"/>	High <input type="checkbox"/>			
	<b>LEGS</b>	Wood <input type="checkbox"/>	Plastic <input type="checkbox"/>	Metal <input type="checkbox"/>	Upholstered <input type="checkbox"/>	Castors <input type="checkbox"/>	

VISUAL APPEARANCE

The product may reveal various wrinkles due to the combination of Elasticity of the covering, characteristics of the interior construction and the design of the product.



Products with Visual Appearance listed as High or Medium would require higher degree of care, where seats and back cushions may require fluffing and plumping more often than Products with Visual Appearance listed as Low.

NOTES

- Designed by Mauro Lipparini.
- The abacus of Buddie is made of seven different modules which can be combined according to the needs of each, to form linear sofas, corner sofas, relaxation islands, symmetrical or asymmetrical compositions, and visionary or more conventional appearances. Each combination can be slightly different from the other, while maintaining comfort and their harmonious and convivial spirit, inviting casual and extraordinary relaxation.
- The backrests, seats and backs - all perfectly padded with durable but soft materials - fit together in an overlap of volumes, a detail with aesthetic and functional value, underlined by a series of irregular seams that enhances its uniqueness.
- It's bevelled geometric shapes are supported by invisible non-slip feet, a detail that adds to its relaxed appearance.
- Model is not available with article Misterbianco (cat. 30).
- Seat and back cushions are fixed to the frame.
- With Leather Side (the sectional pieces come with leather sides)
- Feet will be in a bag inside the package and requires assembling.
- Feet height 4,0 cm

NOTES

---



■ Vers. 888



■ Vers. 888

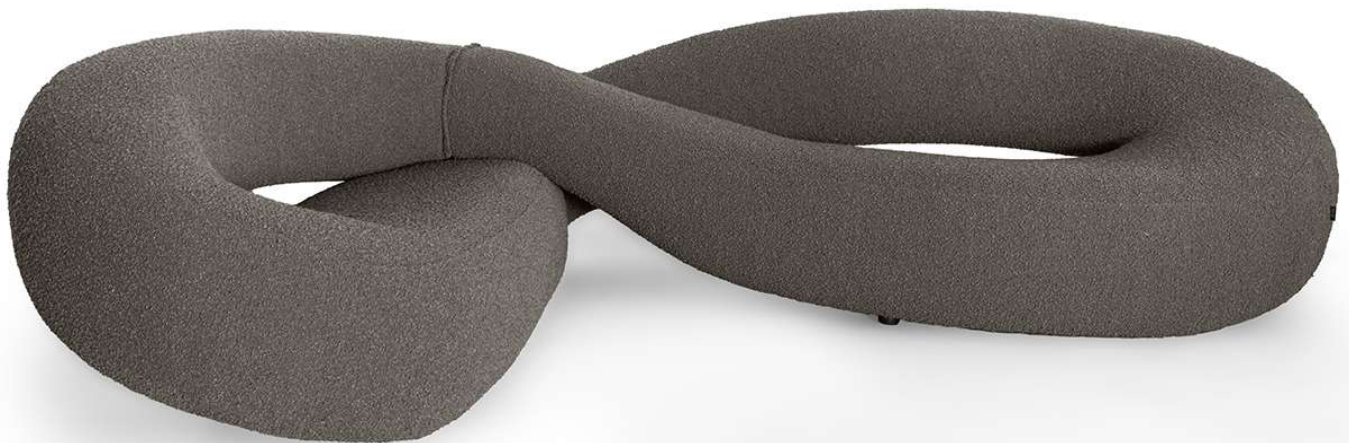



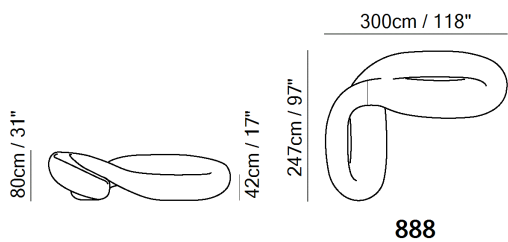

■ Vers. 888

SCHEMATICS

---



TECHNICAL INFORMATION

	<b>COVERING</b>	Soft Cover <input checked="" type="checkbox"/>					
	<b>FILLING</b>	Arms	<input type="checkbox"/> Fiber <input type="checkbox"/> Foam <input type="checkbox"/> Feather/Fiber Mix <input type="checkbox"/> Feather	Seat cushion	<input type="checkbox"/> Fiber <input type="checkbox"/> Foam <input type="checkbox"/> Feather/Fiber Mix <input type="checkbox"/> Feather	Back cushion	<input type="checkbox"/> Fiber <input type="checkbox"/> Foam <input type="checkbox"/> Feather/Fiber Mix <input type="checkbox"/> Feather
	<b>COMFORT</b>	Standard Comfort <input checked="" type="checkbox"/>	Firm Comfort <input type="checkbox"/>				
	<b>FUNCTION</b>	Bed <input type="checkbox"/>	Electric motion <input type="checkbox"/>	Motion <input type="checkbox"/>	Recliner <input type="checkbox"/>	Sliding <input type="checkbox"/>	
	<b>LEGS</b>	Wood <input type="checkbox"/>	Metal <input type="checkbox"/>	Plastic <input type="checkbox"/>	Castors <input type="checkbox"/>	Upholstered <input type="checkbox"/>	

NOTES

- Designed by Marcantonio Raimondi Malerba.
- Date of launch: 2020.
- Infinito came into being thanks to the idea of cross-pollination and to an almost impossible challenge - taking the core aesthetic of one of the most powerful symbols for the human race and turning it into an object that has a strong symbolic value for Natuzzi - the sofa.
- The metal tubular structure gives the sofa a dreamlike and unmistakable shape, while the elastic polyurethane padding of varying density that surrounds it gives this piece of furniture maximum comfort, combining softness and support.
- Infinito is a challenging Design; a technical victory that became a slinky sculpture which glides in and out of itself becoming an inviting sofa perfect for lazing with a comfortable seat and a relaxing chaise-longue in the middle.
- Model is available in fabric only.
- Model available in soft cover Trastevere (cat.88) and Portavenezia (cat.9C).

**NOTES**

---



■ Vers. 064



■ Vers. 200+019



■ Vers. 018+827+049



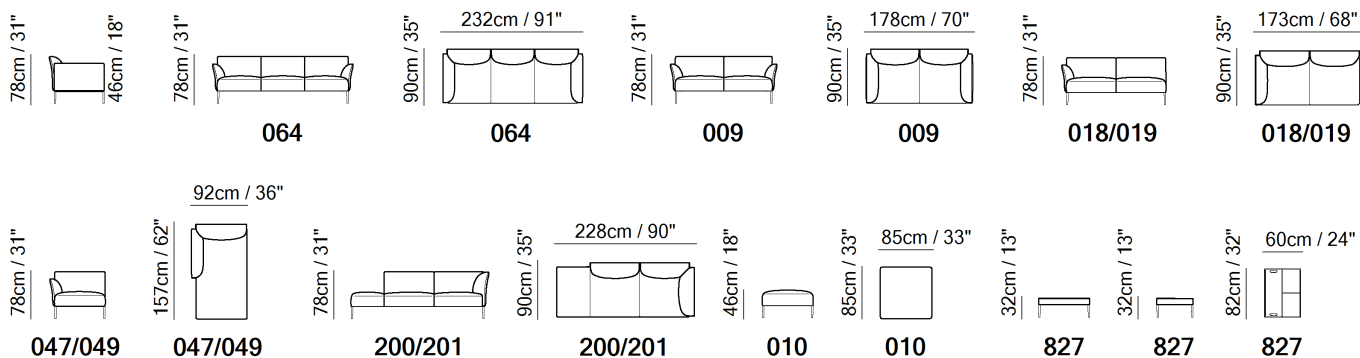

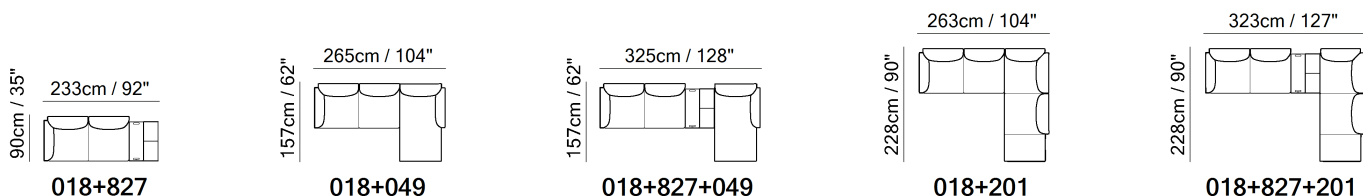

## SCHEMATICS



## COMPOSITION EXAMPLES



TECHNICAL INFORMATION

	<b>COVERING</b>	Leather <input checked="" type="checkbox"/>	Soft Cover <input checked="" type="checkbox"/>				
	<b>FILLING</b>	Arms	<input type="checkbox"/> Fiber <input checked="" type="checkbox"/> Foam <input type="checkbox"/> Feather/Fiber Mix <input type="checkbox"/> Feather	Seat cushion	<input type="checkbox"/> Fiber <input checked="" type="checkbox"/> Foam <input type="checkbox"/> Feather/Fiber Mix <input type="checkbox"/> Feather	Back cushion	<input type="checkbox"/> Fiber <input checked="" type="checkbox"/> Foam <input type="checkbox"/> Feather/Fiber Mix <input type="checkbox"/> Feather
	<b>COMFORT</b>	Standard Comfort <input checked="" type="checkbox"/>	Firm Comfort <input type="checkbox"/>				
	<b>FUNCTION</b>	Bed <input type="checkbox"/>	Electric motion <input type="checkbox"/>	Motion <input type="checkbox"/>	Recliner <input type="checkbox"/>	Sliding <input type="checkbox"/>	
	<b>VISUAL APPEARANCE*</b>	Low <input checked="" type="checkbox"/>	Medium <input type="checkbox"/>	High <input type="checkbox"/>			
	<b>LEGS</b>	Wood <input type="checkbox"/>	Plastic <input type="checkbox"/>	Metal <input type="checkbox"/>	Upholstered <input type="checkbox"/>	Castors <input type="checkbox"/>	

VISUAL APPEARANCE

The product may reveal various wrinkles due to the combination of Elasticity of the covering, characteristics of the interior construction and the design of the product.



Products with Visual Appearance listed as High or Medium would require higher degree of care, where seats and back cushions may require fluffing and plumping more often than Products with Visual Appearance listed as Low.

NOTES

- Designed by Marcel Wanders Studio.
- In leather the model is available starting from cat. 25 (Status).
- Model is not available with article Misterbianco (cat. 30).
- Wide seats despite general small scale of model thanks to slim armrest.
- Absolute comfortable seat cushions thanks to a new polyurethane foam with high density (50).
- Glossy black finishing (FT71) and polished chrome (FT77) open base design gives a feeling of lightness to the model.
- Version 827: Table top in black ash wood (51) or Honey ash wood (55) combined with metal base of the sofa selectable between glossy black (FT71) or polished chrome (FT77).
- Internal wooden frame.

NOTES

---



■ Vers. 009



■ Vers. 220+291+274



■ Vers. 016+076+073



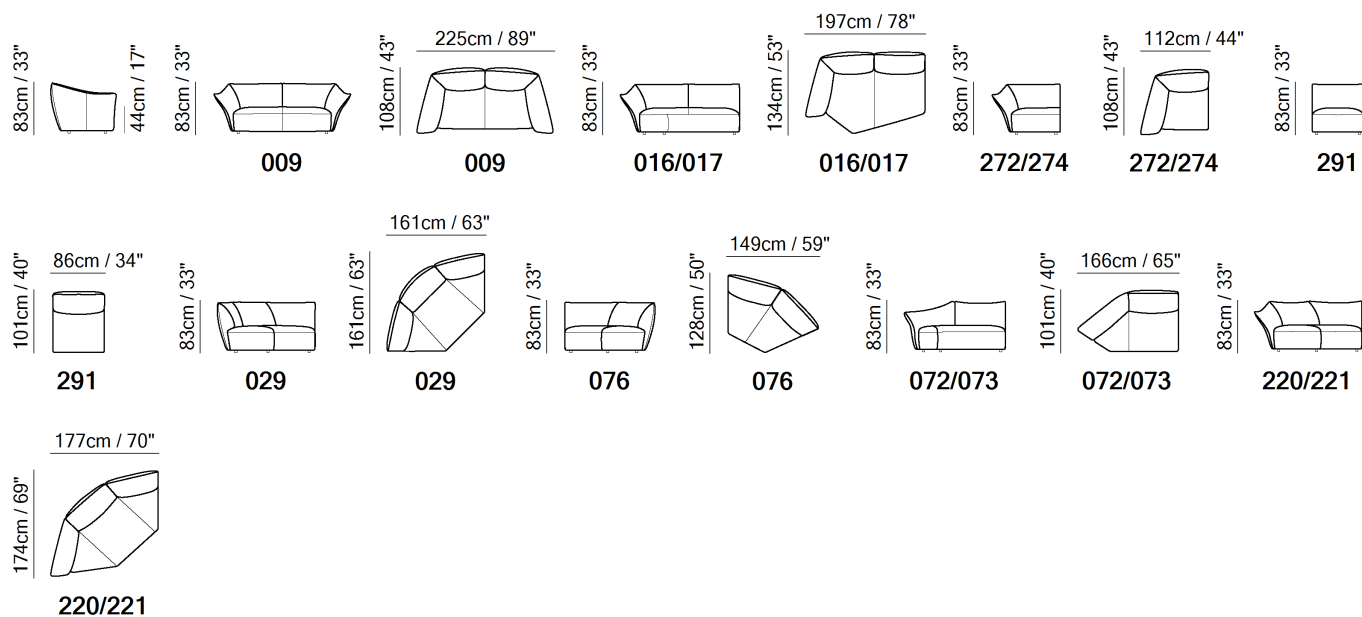

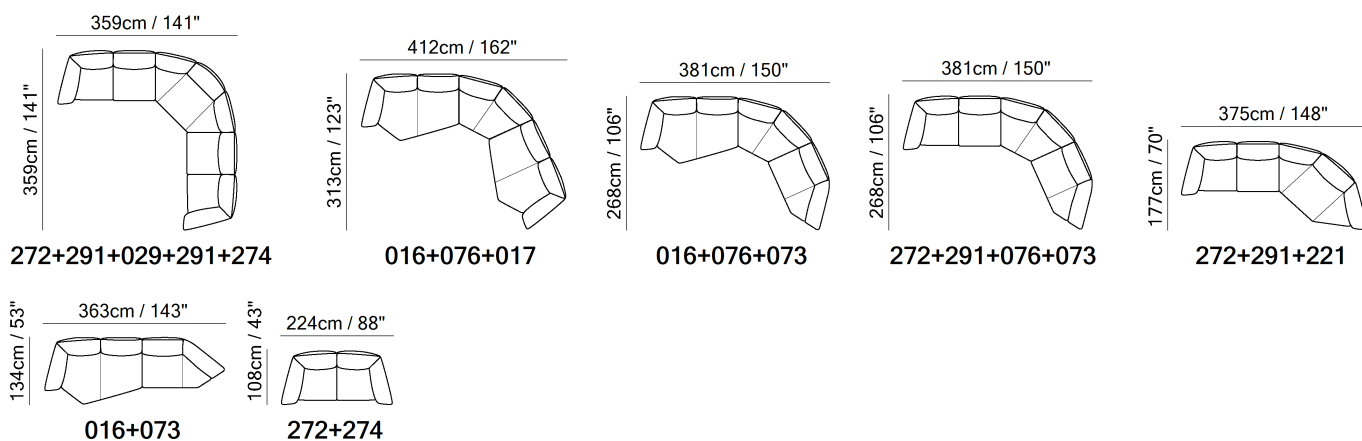

## SCHEMATICS



## COMPOSITION EXAMPLES



TECHNICAL INFORMATION

	<b>COVERING</b>	Leather <input checked="" type="checkbox"/>	Soft Cover <input checked="" type="checkbox"/>			
	<b>FILLING</b>	Arms <input type="checkbox"/> Fiber <input checked="" type="checkbox"/> Foam <input type="checkbox"/> Feather/Fiber Mix <input type="checkbox"/> Feather	Seat cushion <input type="checkbox"/> Fiber <input checked="" type="checkbox"/> Foam <input type="checkbox"/> Feather/Fiber Mix <input type="checkbox"/> Feather	Back cushion <input type="checkbox"/> Fiber <input checked="" type="checkbox"/> Foam <input type="checkbox"/> Feather/Fiber Mix <input type="checkbox"/> Feather		
	<b>COMFORT</b>	Standard Comfort <input checked="" type="checkbox"/>	Firm Comfort <input type="checkbox"/>			
	<b>FUNCTION</b>	Bed <input type="checkbox"/>	Electric motion <input type="checkbox"/>	Motion <input type="checkbox"/>	Recliner <input type="checkbox"/>	Sliding <input type="checkbox"/>
	<b>VISUAL APPEARANCE*</b>	Low <input checked="" type="checkbox"/>	Medium <input type="checkbox"/>	High <input type="checkbox"/>		
	<b>LEGS</b>	Wood <input type="checkbox"/>	Metal <input checked="" type="checkbox"/>	Plastic <input type="checkbox"/>	Castors <input type="checkbox"/>	Upholstered <input type="checkbox"/>

VISUAL APPEARANCE

The product may reveal various wrinkles due to the combination of Elasticity of the covering, characteristics of the interior construction and the design of the product.



Products with Visual Appearance listed as High or Medium would require higher degree of care, where seats and back cushions may require fluffing and plumping more often than Products with Visual Appearance listed as Low.

NOTES

- In leather the model is available starting from cat. 25 (Status).
- Model is not available with article Misterbianco (cat. 30).
- Upholstered side
- Internal structure in molded polyurethane.  
Production process:
  - 1) Polyurethane resin shape.
  - 2) The mold is obtained from this shape
  - 3) Inside the mold there is a metal structure that acts as the backbone of the sofa.
  - 4) Afterwards the high-density polyurethane (50) is injected into the mold.
  - 5) After a specific period of time, this shape stiffens and becomes the body of the sofa.
  - 6) This structure is bonded with a layer of transformed lower density polyurethane to give softness to the seat, to the back and armrests.
  - 7) Everything is covered with dacron, leather or fabric.
  - 8) The end result is a comfort, design and support unchanged over time
- The hidden metal feet with anti-scratch and non-slip rubbers offer a practical solution for protecting floors.

**NOTES**

---



■ Vers. 446



■ Vers. 446



■ Vers. 048



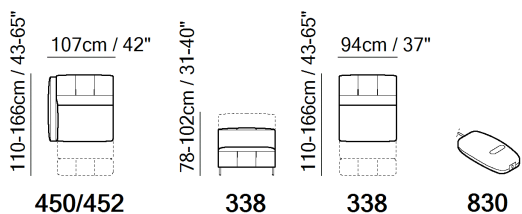
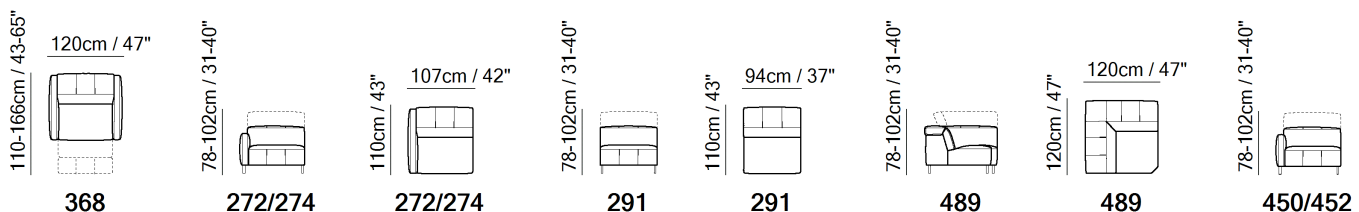
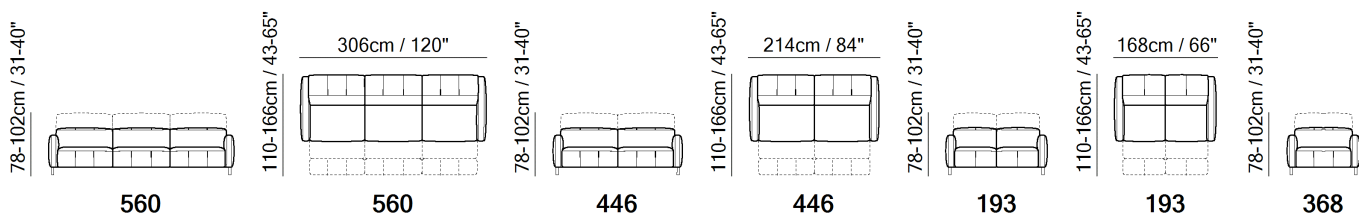
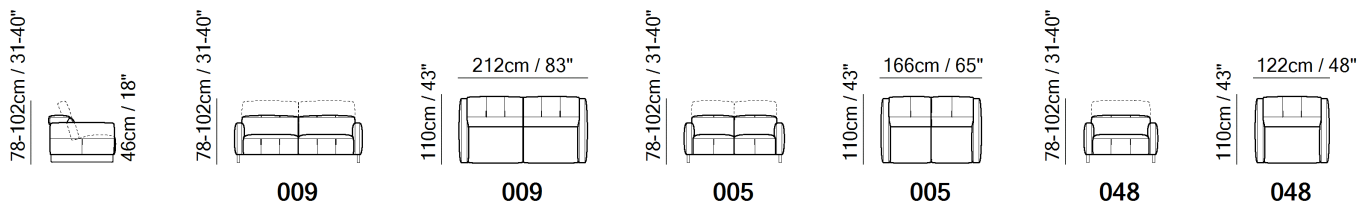

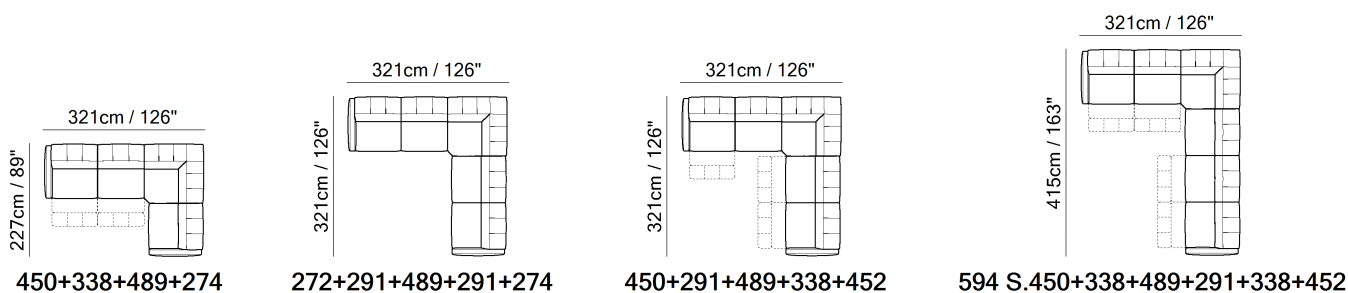

## SCHEMATICS



## COMPOSITION EXAMPLES



TECHNICAL INFORMATION

	<b>COVERING</b>	Leather <input checked="" type="checkbox"/>	Soft Cover <input checked="" type="checkbox"/>			
	<b>FILLING</b>	Arms <input type="checkbox"/> Fiber <input checked="" type="checkbox"/> Foam <input type="checkbox"/> Feather/Fiber Mix <input type="checkbox"/> Feather	Seat cushion <input type="checkbox"/> Fiber <input checked="" type="checkbox"/> Foam <input type="checkbox"/> Feather/Fiber Mix <input type="checkbox"/> Feather	Back cushion <input type="checkbox"/> Fiber <input checked="" type="checkbox"/> Foam <input type="checkbox"/> Feather/Fiber Mix <input type="checkbox"/> Feather		
	<b>COMFORT</b>	Standard Comfort <input checked="" type="checkbox"/>	Firm Comfort <input type="checkbox"/>			
	<b>FUNCTION</b>	Bed <input type="checkbox"/>	Electric motion <input checked="" type="checkbox"/>	Motion <input checked="" type="checkbox"/>	Recliner <input checked="" type="checkbox"/>	Sliding <input type="checkbox"/>
	<b>VISUAL APPEARANCE*</b>	Low <input checked="" type="checkbox"/>	Medium <input type="checkbox"/>	High <input type="checkbox"/>		
	<b>LEGS</b>	Wood <input type="checkbox"/>	Plastic <input type="checkbox"/>	Metal <input checked="" type="checkbox"/>	Upholstered <input type="checkbox"/>	Castors <input type="checkbox"/>

VISUAL APPEARANCE

The product may reveal various wrinkles due to the combination of Elasticity of the covering, characteristics of the interior construction and the design of the product.



Products with Visual Appearance listed as High or Medium would require higher degree of care, where seats and back cushions may require fluffing and plumping more often than Products with Visual Appearance listed as Low.

NOTES

- Designed by Natuzzi Design Center.
- Date of launch: 2021.
- In leather, model is available starting from cat. 10.
- Adjustable headrest on all versions.
- The model has visible internal buttons to activate the mechanism.
- Model has power combined headrest. ATTENTION! The headrest opens first followed by the footrest; then the headrest has one final extra rotation for comfortable TV watching position.
- Seat and back cushions in high density polyurethane foam (35).
- Thanks to ZeroWall mechanism, seat and back cushions can be reclined at a great length without moving sofa away from the wall.
- Version 560, a three seater sofa where each seat has its own electric mechanism.
- A battery pack can be ordered with its own version code 830. For order entry please use XX for category and XXX for cover code. In order to optimize the duration of the battery, it is suggested to order one per each motion seat.
- Seat and back cushions are fixed to the frame.
- No Leather/Fabric Side (the sectional pieces have the side covered with lining and not leather nor fabric)
- Internal wooden frame.

## NOTES

---

- Feet will be in a bag inside the package and requires assembling.
- Feet available in metal finishings 77 (Glossy Chromed) / 78 (Black Chrome)
- Feet height 13,0 cm



■ Vers. F54



■ Vers. F54







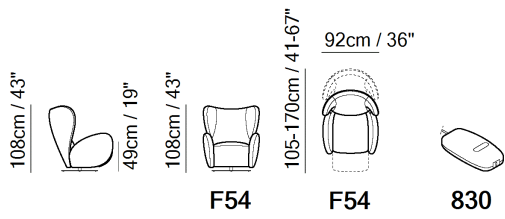

■ Vers. F54

SCHEMATICS

---



TECHNICAL INFORMATION

	<b>COVERING</b>	Leather <input checked="" type="checkbox"/>	Soft Cover <input checked="" type="checkbox"/>				
	<b>FILLING</b>	Arms	<input type="checkbox"/> Fiber <input checked="" type="checkbox"/> Foam <input type="checkbox"/> Feather/Fiber Mix <input type="checkbox"/> Feather	Seat cushion	<input type="checkbox"/> Fiber <input checked="" type="checkbox"/> Foam <input type="checkbox"/> Feather/Fiber Mix <input type="checkbox"/> Feather	Back cushion	<input type="checkbox"/> Fiber <input checked="" type="checkbox"/> Foam <input type="checkbox"/> Feather/Fiber Mix <input type="checkbox"/> Feather
	<b>COMFORT</b>	Standard Comfort <input checked="" type="checkbox"/>	Firm Comfort <input type="checkbox"/>				
	<b>FUNCTION</b>	Bed <input type="checkbox"/>	Electric motion <input type="checkbox"/>	Motion <input type="checkbox"/>	Recliner <input type="checkbox"/>	Sliding <input type="checkbox"/>	
	<b>VISUAL APPEARANCE*</b>	Low <input checked="" type="checkbox"/>	Medium <input type="checkbox"/>	High <input type="checkbox"/>			
	<b>LEGS</b>	Wood <input type="checkbox"/>	Metal <input type="checkbox"/>	Plastic <input type="checkbox"/>	Castors <input type="checkbox"/>	Upholstered <input type="checkbox"/>	

VISUAL APPEARANCE

The product may reveal various wrinkles due to the combination of Elasticity of the covering, characteristics of the interior construction and the design of the product.



Products with Visual Appearance listed as High or Medium would require higher degree of care, where seats and back cushions may require fluffing and plumping more often than Products with Visual Appearance listed as Low.

NOTES

- Designed by Natuzzi Design Center.
- Date of launch: 2021.
- Available in leather or fabric.
- In leather the model is available starting from cat. 15 (Le Mans).
- Model is not available with article Misterbianco (cat. 30).
- Swivel base with 270 rotation, available in 79 matt black finish
- Dual power motion recliner: soft touch buttons positioned, two on the right and two on the left, between seat and armrest.
  - Sitting down, the two left buttons open and close the footboard. The closing button is also equipped with the HOME function that closes all the mechanisms.
  - The two right buttons, on the other hand, activate the opening and closing of the wall bars.
- Plug on the back shell to connect the electrical cables.  
Version 830 is available in order to avoid the imperfections of electrical cables and to place the chair in the middle of the room. It contains the battery kit that must be placed under the seat.

NOTES

---



■ Vers. 009



■ Vers. 586



■ Vers. 018+481



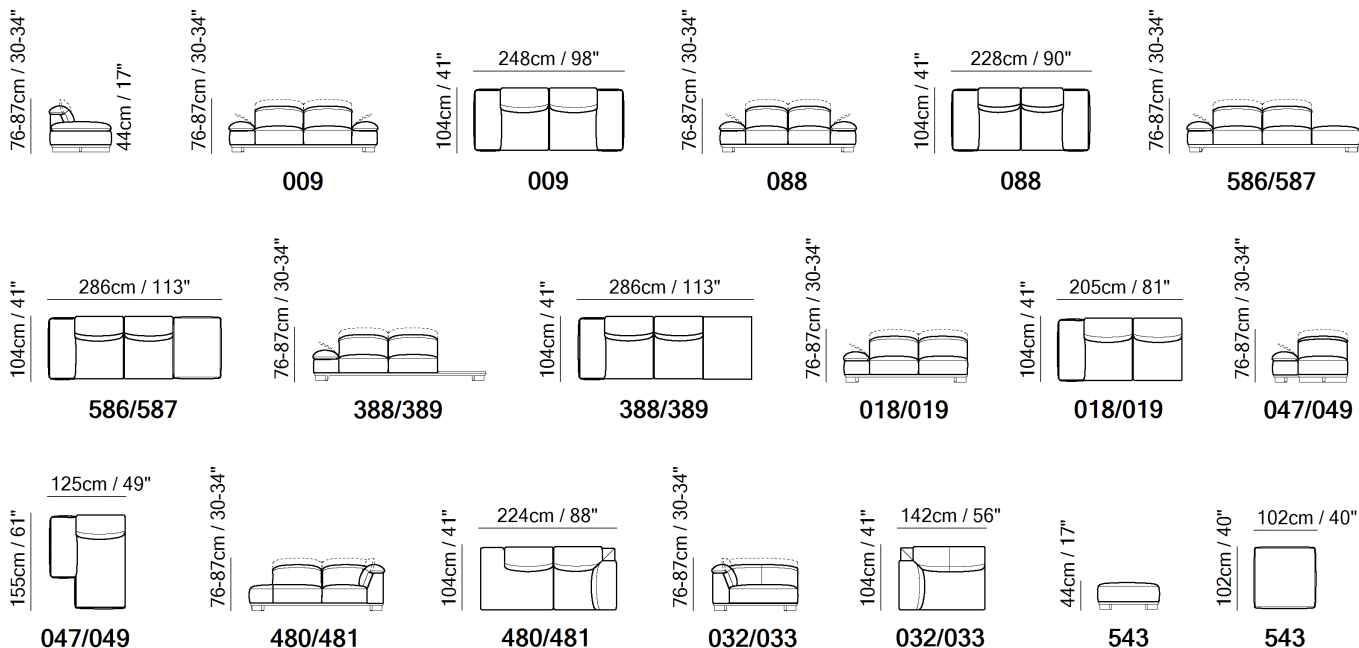

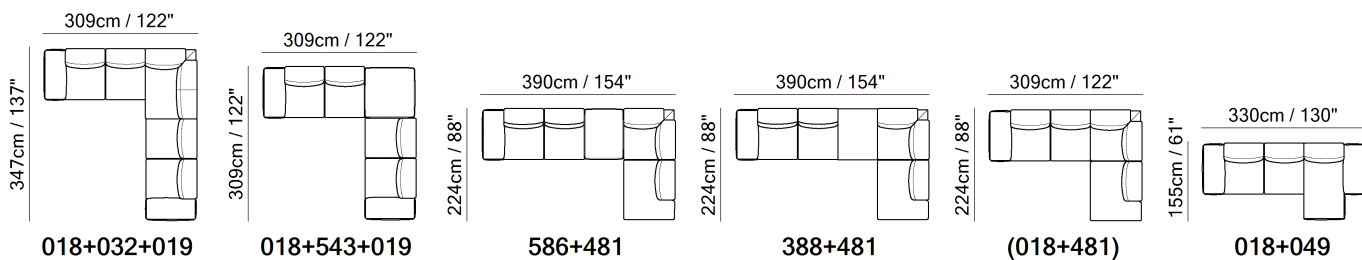

**SCHEMATICS**



**COMPOSITION EXAMPLES**



TECHNICAL INFORMATION

	<b>COVERING</b>	Leather <input checked="" type="checkbox"/>	Soft Cover <input checked="" type="checkbox"/>			
	<b>FILLING</b>	Arms <input type="checkbox"/> Fiber <input checked="" type="checkbox"/> Foam <input type="checkbox"/> Feather/Fiber Mix <input type="checkbox"/> Feather	Seat cushion <input type="checkbox"/> Fiber <input checked="" type="checkbox"/> Foam <input type="checkbox"/> Feather/Fiber Mix <input type="checkbox"/> Feather	Back cushion <input type="checkbox"/> Fiber <input checked="" type="checkbox"/> Foam <input type="checkbox"/> Feather/Fiber Mix <input type="checkbox"/> Feather		
	<b>COMFORT</b>	Standard Comfort <input checked="" type="checkbox"/>	Firm Comfort <input type="checkbox"/>			
	<b>FUNCTION</b>	Bed <input type="checkbox"/>	Electric motion <input type="checkbox"/>	Motion <input type="checkbox"/>	Recliner <input type="checkbox"/>	Sliding <input type="checkbox"/>
	<b>VISUAL APPEARANCE*</b>	Low <input checked="" type="checkbox"/>	Medium <input type="checkbox"/>	High <input type="checkbox"/>		
	<b>LEGS</b>	Wood <input type="checkbox"/>	Plastic <input type="checkbox"/>	Metal <input type="checkbox"/>	Upholstered <input type="checkbox"/>	Castors <input type="checkbox"/>

VISUAL APPEARANCE

The product may reveal various wrinkles due to the combination of Elasticity of the covering, characteristics of the interior construction and the design of the product.



Products with Visual Appearance listed as High or Medium would require higher degree of care, where seats and back cushions may require fluffing and plumping more often than Products with Visual Appearance listed as Low.

NOTES

- Designed by Marcel Wanders Studio.
- Date of launch: 2022.
- Model not available in Misterbianco and Cassidy leathers.
- Seat cushion includes a layer of memory foam, a pressure-sensitive soft polyurethane, that recovers its form completely thus giving great comfort.
- Adjustable headrest on all versions.
- Adjustable armrest in several positions with click mechanism in the opening phase and frictioned mechanism in the closing phase.
- Model available with metal base to order as V242.
- Microcellular polyurethane foam padding made from a plant based raw material, drawing from renewable sources found in nature.
- Such padding meets the demands of a market that is increasingly sensitive to products with a low environmental impact and ensures maximum comfort, thanks to high production technology and the high quality of the raw materials from which it is made. The seat is composed of polyurethane foam with density 50 combined with a layer of memory foam 2 cm high.
- Upholstered sofa sides with hidden and removable hooks

NOTES

---



■ Vers. 256



■ Vers. 256







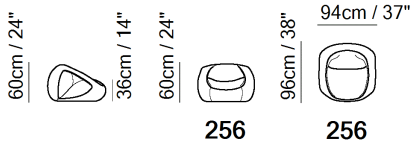

■ Vers. 256+256+256

SCHEMATICS

---



TECHNICAL INFORMATION

	<b>COVERING</b>	Leather <input checked="" type="checkbox"/>	Soft Cover <input checked="" type="checkbox"/>				
	<b>FILLING</b>	Arms	<input type="checkbox"/> Fiber <input type="checkbox"/> Foam <input type="checkbox"/> Feather/Fiber Mix <input type="checkbox"/> Feather	Seat cushion	<input type="checkbox"/> Fiber <input type="checkbox"/> Foam <input type="checkbox"/> Feather/Fiber Mix <input type="checkbox"/> Feather	Back cushion	<input type="checkbox"/> Fiber <input type="checkbox"/> Foam <input type="checkbox"/> Feather/Fiber Mix <input type="checkbox"/> Feather
	<b>COMFORT</b>	Standard Comfort <input checked="" type="checkbox"/>	Firm Comfort <input type="checkbox"/>				
	<b>FUNCTION</b>	Bed <input type="checkbox"/>	Electric motion <input type="checkbox"/>	Motion <input type="checkbox"/>	Recliner <input type="checkbox"/>	Sliding <input type="checkbox"/>	
	<b>VISUAL APPEARANCE*</b>	Low <input checked="" type="checkbox"/>	Medium <input type="checkbox"/>	High <input type="checkbox"/>			
	<b>LEGS</b>	Wood <input type="checkbox"/>	Metal <input type="checkbox"/>	Plastic <input type="checkbox"/>	Castors <input type="checkbox"/>	Upholstered <input type="checkbox"/>	

VISUAL APPEARANCE

The product may reveal various wrinkles due to the combination of Elasticity of the covering, characteristics of the interior construction and the design of the product.



Products with Visual Appearance listed as High or Medium would require higher degree of care, where seats and back cushions may require fluffing and plumping more often than Products with Visual Appearance listed as Low.

NOTES

- Designed by Marcantonio Raimondi Malerba.
- Produced in Natuzzi Italia plants equipped with over two thousand photovoltaic panels and flueless. Each component of Pouf Terra is totally recyclable.
- Available both with eco-friendly coverings such as Byborre, Gaia but also in the vast collection of NI covers both leather and fabric
- Padding in recycled polystyrene that make it light and adaptable in shape to achieve the desired comfort
- Iconic design that can be used in different environments of the house

NOTES

---



■ Vers. 066



■ Vers. 066



■ Vers. 066







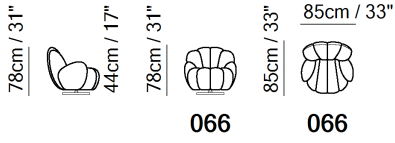

SCHEMATICS

---



TECHNICAL INFORMATION

	<b>COVERING</b>	Soft Cover <input checked="" type="checkbox"/>					
	<b>FILLING</b>	Arms	<input type="checkbox"/> Fiber <input checked="" type="checkbox"/> Foam <input type="checkbox"/> Feather/Fiber Mix <input type="checkbox"/> Feather	Seat cushion	<input type="checkbox"/> Fiber <input checked="" type="checkbox"/> Foam <input type="checkbox"/> Feather/Fiber Mix <input type="checkbox"/> Feather	Back cushion	<input type="checkbox"/> Fiber <input checked="" type="checkbox"/> Foam <input type="checkbox"/> Feather/Fiber Mix <input type="checkbox"/> Feather
	<b>COMFORT</b>	Standard Comfort <input checked="" type="checkbox"/>	Firm Comfort <input type="checkbox"/>				
	<b>FUNCTION</b>	Bed <input type="checkbox"/>	Electric motion <input type="checkbox"/>	Motion <input type="checkbox"/>	Recliner <input type="checkbox"/>	Sliding <input type="checkbox"/>	
	<b>VISUAL APPEARANCE*</b>	Low <input type="checkbox"/>	Medium <input checked="" type="checkbox"/>	High <input type="checkbox"/>			
	<b>LEGS</b>	Wood <input type="checkbox"/>	Plastic <input type="checkbox"/>	Metal <input type="checkbox"/>	Upholstered <input type="checkbox"/>	Castors <input type="checkbox"/>	

VISUAL APPEARANCE

The product may reveal various wrinkles due to the combination of Elasticity of the covering, characteristics of the interior construction and the design of the product.



Products with Visual Appearance listed as High or Medium would require higher degree of care, where seats and back cushions may require fluffing and plumping more often than Products with Visual Appearance listed as Low.

NOTES

- Designed by Natuzzi Design Center.
- Date of launch: 2023.
- 
- Not available in leather and in the following fabrics: Sparano, Portocervo, Scilla, Noto, Costiera, Delfino, Farini, Borgospesso, Gaia and Origani.
- Available with swivel 360° mechanism.

NOTES

---



■ Vers. 272+291+274









■ Vers. 463+291+011+274



■ Vers. 272+291+011+274



TECHNICAL INFORMATION

	<b>COVERING</b>	Leather <input checked="" type="checkbox"/>	Soft Cover <input checked="" type="checkbox"/>			
	<b>FILLING</b>	Arms <input type="checkbox"/> Fiber <input checked="" type="checkbox"/> Foam <input type="checkbox"/> Feather/Fiber Mix <input type="checkbox"/> Feather	Seat cushion <input type="checkbox"/> Fiber <input checked="" type="checkbox"/> Foam <input type="checkbox"/> Feather/Fiber Mix <input type="checkbox"/> Feather	Back cushion <input type="checkbox"/> Fiber <input checked="" type="checkbox"/> Foam <input type="checkbox"/> Feather/Fiber Mix <input type="checkbox"/> Feather		
	<b>COMFORT</b>	Standard Comfort <input checked="" type="checkbox"/>	Firm Comfort <input type="checkbox"/>			
	<b>FUNCTION</b>	Bed <input type="checkbox"/>	Electric motion <input type="checkbox"/>	Motion <input type="checkbox"/>	Recliner <input type="checkbox"/>	Sliding <input type="checkbox"/>
	<b>VISUAL APPEARANCE*</b>	Low <input type="checkbox"/>	Medium <input checked="" type="checkbox"/>	High <input type="checkbox"/>		
	<b>LEGS</b>	Wood <input type="checkbox"/>	Metal <input type="checkbox"/>	Plastic <input checked="" type="checkbox"/>	Castors <input type="checkbox"/>	Upholstered <input type="checkbox"/>

VISUAL APPEARANCE

The product may reveal various wrinkles due to the combination of Elasticity of the covering, characteristics of the interior construction and the design of the product.



Products with Visual Appearance listed as High or Medium would require higher degree of care, where seats and back cushions may require fluffing and plumping more often than Products with Visual Appearance listed as Low.

NOTES

- Designed by Natuzzi Design Center.
- Date of launch: 2023.
- Modular sofa with marked versatility. With just a few elements, it composes islands of comfort with an informal look while maintaining its rigorous expression given by its essential silhouette. Semplice satisfies every need for space and comfort. Easy to customize, few modules allow for endless configuration possibilities to suit your space. It's a modern marriage of versatility, perfect proportions and unmatched comfort.
- Loose cushions in two sizes (vers. 089/109) can be ordered in different coverings and colors. They can be used as lumbar support or as support next to the armrest or simply as decorative items.
- Seat and back cushions in high density poliurethane (35) have a layer of Climalight lining. The lining contains Microflock microfibre made of 100% recycled polyester from PET. Microflock is extremely soft and also regains its original shape after use.
- Back and seat cushions can be removed from frame.
- The back cushions have a roller that rests on the backrest in order to ensure greater support. It can be positioned according to anyone's height to find the desired ergonomics.
- Version 463 can be used as either an ottoman or corner without backrest as it is equipped with hooks.
- Under the seat there are elastic straps which guarantee the same comfort for every seat and more lasting support.

## NOTES

---

- Upholstered sofa sides with hidden and removable hooks
- Feet will be in a bag inside the package and requires assembling.
- Anti-scratch and non-slip hidden feet.
- Feet height 4 cm.



■ Vers. 272+217



■ Vers. 009



■ Vers. 294+379



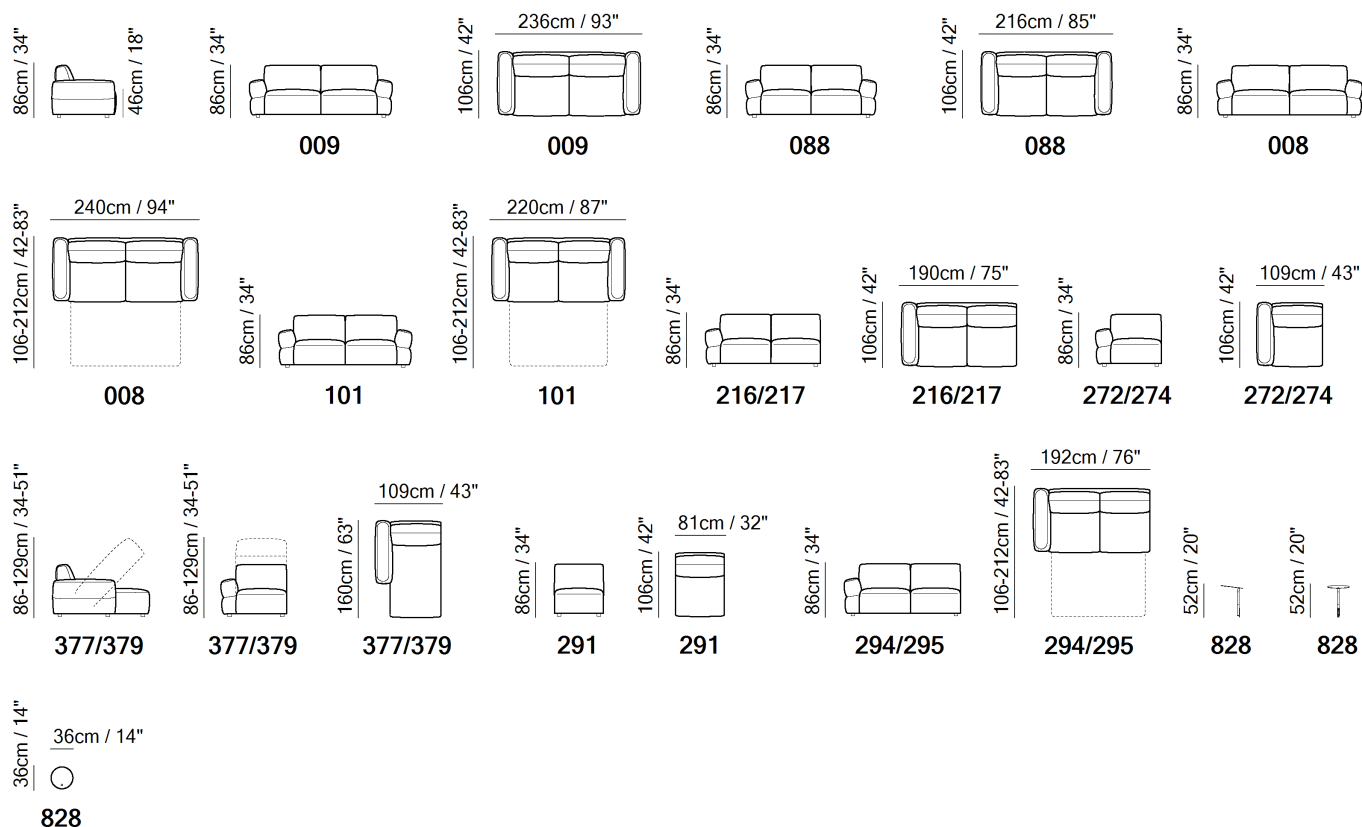



## SCHEMATICS



## COMPOSITION EXAMPLES



TECHNICAL INFORMATION

	<b>COVERING</b>	Leather <input checked="" type="checkbox"/>	Soft Cover <input checked="" type="checkbox"/>				
	<b>FILLING</b>	Arms	<input type="checkbox"/> Fiber <input checked="" type="checkbox"/> Foam <input type="checkbox"/> Feather/Fiber Mix <input type="checkbox"/> Feather	Seat cushion	<input type="checkbox"/> Fiber <input checked="" type="checkbox"/> Foam <input type="checkbox"/> Feather/Fiber Mix <input type="checkbox"/> Feather	Back cushion	<input type="checkbox"/> Fiber <input checked="" type="checkbox"/> Foam <input type="checkbox"/> Feather/Fiber Mix <input type="checkbox"/> Feather
	<b>COMFORT</b>	Standard Comfort <input checked="" type="checkbox"/>	Firm Comfort <input type="checkbox"/>				
	<b>FUNCTION</b>	Bed <input checked="" type="checkbox"/>	Electric motion <input type="checkbox"/>	Motion <input type="checkbox"/>	Recliner <input type="checkbox"/>	Sliding <input type="checkbox"/>	
	<b>VISUAL APPEARANCE*</b>	Low <input checked="" type="checkbox"/>	Medium <input type="checkbox"/>	High <input type="checkbox"/>			
	<b>LEGS</b>	Wood <input type="checkbox"/>	Plastic <input type="checkbox"/>	Metal <input checked="" type="checkbox"/>	Upholstered <input type="checkbox"/>	Castors <input type="checkbox"/>	

VISUAL APPEARANCE

The product may reveal various wrinkles due to the combination of Elasticity of the covering, characteristics of the interior construction and the design of the product.



Products with Visual Appearance listed as High or Medium would require higher degree of care, where seats and back cushions may require fluffing and plumping more often than Products with Visual Appearance listed as Low.

BED MECHANISM & MATTRESS

MECHANISM		MATTRESS		
VERSIONS	TYPE	VERSIONS	TYPE	DIMENSIONS
				W L H
		101,294,295	GREENPLUS	140 195 11
		008	GREENPLUS	160 195 11

**GREENPLUS** GREENPLUS mattress is a patented, innovative product. It is ecological, made up of microporous elastomers. It has a great adaptation capacity to the various body pressure which gives big support to the spine. It is antibacterial and no-allergic.

NOTES

- Designed by Natuzzi Design Center.
- Date of launch: 2023.
- Available in leather or fabric.
- In leather, to avoid cuts on the seat and back cushions, the model is available starting from cat. 15; only in article LE MANS
- Model is not available with article Misterbianco (cat. 30).
- Easy sofa was born from the need to have a user-friendly product equipped with a "ready-to-bed" mechanism without renouncing the typical comfort of a sofa without function. The modern and rounded style gives it unparalleled visual comfort.
- On the side of the armrest there is a pocket outlined by a border. When the sofa is in leather, the piping is tone-on-tone, when the sofa is in fabric, the piping can be in contrasting leather (Le Mans cat.15) or tone-on-tone fabric.
- Seat cushions in high density polyurethane (35) with standard comfort.

## NOTES

---

- Comfort is firmer when ordered as a sofa bed.
- Slatted bed base.
- Greenplus mattress 11 cm high, in size 160cm or 140cm.
- Sofa bed versions (008/101) are equipped with a lever.  
Lever is hidden between the armrest and the seat. When lifted, raises the sofa by a few centimetres, allowing the wheels to move and making it easier to move the sofa.  
When the lever is placed down it is hidden and the wheels do not move.
- Chaise-longue always with storage.
- Version 828: optional rotating metal support can be attached to the armrest. Bedside table or tray when the sofa is used as a bed. Coffee table when the sofa is used as a standard sofa.
- Feet will be in a bag inside the package and requires assembling.
- The hidden metal feet with anti-scratch and non-slip rubbers offer a practical solution for protecting floors.
- Feet height 4,5 cm.



■ Vers. 101



■ Vers. 101



■ Vers. 101

## SCHEMATICS

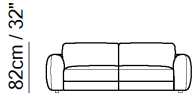

009

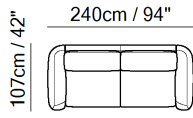

009

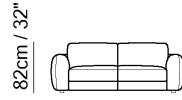

088

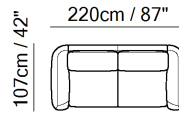

088

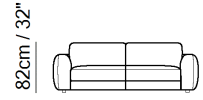

008

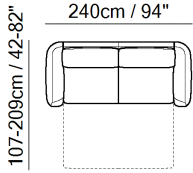

008

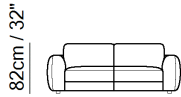



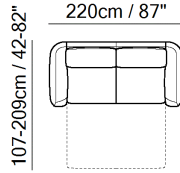



101



101

TECHNICAL INFORMATION

	<b>COVERING</b>	Soft Cover <input checked="" type="checkbox"/>			
	<b>FILLING</b>	Arms	Seat cushion	Back cushion	
		<input type="checkbox"/> Fiber	<input type="checkbox"/> Fiber	<input type="checkbox"/> Fiber	
		<input checked="" type="checkbox"/> Foam	<input checked="" type="checkbox"/> Foam	<input checked="" type="checkbox"/> Foam	
		<input type="checkbox"/> Feather/Fiber Mix	<input type="checkbox"/> Feather/Fiber Mix	<input type="checkbox"/> Feather/Fiber Mix	
		<input type="checkbox"/> Feather	<input type="checkbox"/> Feather	<input type="checkbox"/> Feather	
	<b>COMFORT</b>	Standard Comfort <input checked="" type="checkbox"/>	Firm Comfort <input checked="" type="checkbox"/>		
	<b>FUNCTION</b>	Bed <input checked="" type="checkbox"/>	Electric motion <input type="checkbox"/>	Motion <input type="checkbox"/>	Recliner <input type="checkbox"/>
					Sliding <input type="checkbox"/>
	<b>VISUAL APPEARANCE*</b>	Low <input checked="" type="checkbox"/>	Medium <input type="checkbox"/>	High <input type="checkbox"/>	
	<b>LEGS</b>	Wood <input type="checkbox"/>	Metal <input checked="" type="checkbox"/>	Plastic <input type="checkbox"/>	Castors <input type="checkbox"/>
					Upholstered <input type="checkbox"/>

VISUAL APPEARANCE

The product may reveal various wrinkles due to the combination of Elasticity of the covering, characteristics of the interior construction and the design of the product.



Products with Visual Appearance listed as High or Medium would require higher degree of care, where seats and back cushions may require fluffing and plumping more often than Products with Visual Appearance listed as Low.

BED MECHANISM & MATTRESS

MECHANISM		MATTRESS		
VERSIONS	TYPE	VERSIONS	TYPE	DIMENSIONS
101	Ready-Bed electro-welded - Double folding	101	GREENPLUS	W L H 140 195 11
008	Ready-Bed electro-welded - Double folding	008	GREENPLUS	160 195 11

**Ready-Bed electro-welded** The back cushion goes under the bed mechanism.  
**GREENPLUS** GREENPLUS mattress is a patented, innovative product. It is ecological, made up of microporous elastomers. It has a great adaptation capacity to the various body pressure which gives big support to the spine. It is antibacterial and no-allergic.

NOTES

- Designed by Natuzzi Design Center.
- Date of launch: 2023.
- Simple offers a high comfortable experience while maintaining a modern look thanks to its essential lines.
- Model is available in fabric.
- Seat cushions in high density polyurethane (35) with standard comfort.
- Comfort is firmer when ordered as a sofabed.
- Electro-welded bed base.
- Greenplus mattress 11 cm high, in size 160cm or 140cm.

## NOTES

---

- Sofa bed versions (008/101) are equipped with a lever.  
Lever is hidden between the armrest and the seat. When lifted, raises the sofa by a few centimetres, allowing the wheels to move and making it easier to move the sofa.  
When the lever is placed down it is hidden and the wheels do not move.
- "Ready-to-bed" mechanism. A handle positioned on the backrest allows for easy opening, transforming the sofa into a sofa bed in a single gesture.
- Feet will be in a bag inside the package and requires assembling.
- The hidden metal feet with anti-scratch and non-slip rubbers offer a practical solution for protecting floors.
- Feet height 4 cm.



■ Vers. 272+291+274



■ Vers. 047+291+274



■ Vers. 272+291+045+045+274



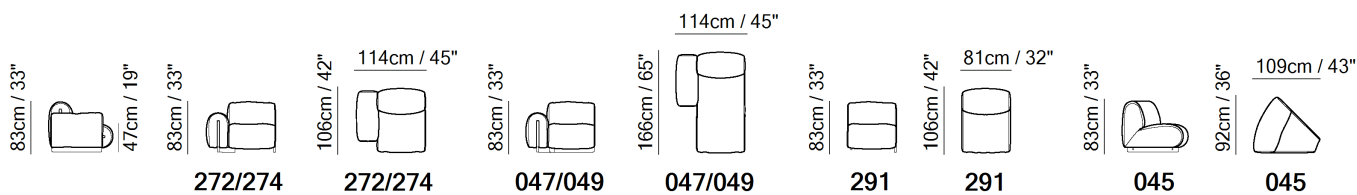

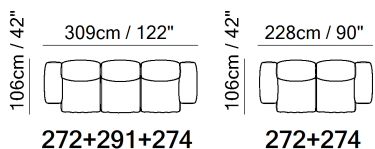
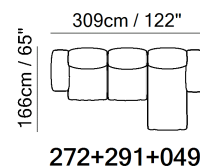
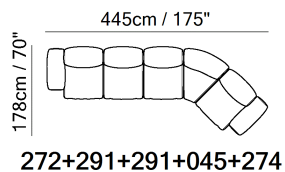
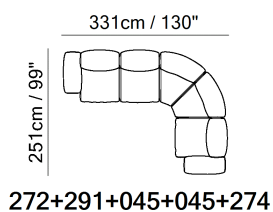
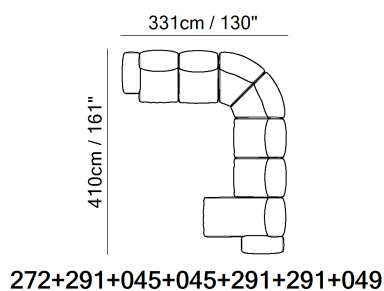

## SCHEMATICS



## COMPOSITION EXAMPLES



TECHNICAL INFORMATION

	<b>COVERING</b>	Leather <input checked="" type="checkbox"/>	Soft Cover <input checked="" type="checkbox"/>				
	<b>FILLING</b>	Arms	<input type="checkbox"/> Fiber <input checked="" type="checkbox"/> Foam <input checked="" type="checkbox"/> Feather/Fiber Mix <input type="checkbox"/> Feather	Seat cushion	<input type="checkbox"/> Fiber <input checked="" type="checkbox"/> Foam <input checked="" type="checkbox"/> Feather/Fiber Mix <input type="checkbox"/> Feather	Back cushion	<input type="checkbox"/> Fiber <input checked="" type="checkbox"/> Foam <input checked="" type="checkbox"/> Feather/Fiber Mix <input type="checkbox"/> Feather
	<b>COMFORT</b>	Standard Comfort <input checked="" type="checkbox"/>	Firm Comfort <input type="checkbox"/>				
	<b>FUNCTION</b>	Bed <input type="checkbox"/>	Electric motion <input type="checkbox"/>	Motion <input type="checkbox"/>	Recliner <input type="checkbox"/>	Sliding <input type="checkbox"/>	
	<b>VISUAL APPEARANCE*</b>	Low <input type="checkbox"/>	Medium <input type="checkbox"/>	High <input checked="" type="checkbox"/>			
	<b>LEGS</b>	Wood <input type="checkbox"/>	Plastic <input type="checkbox"/>	Metal <input type="checkbox"/>	Upholstered <input type="checkbox"/>	Castors <input type="checkbox"/>	

VISUAL APPEARANCE

The product may reveal various wrinkles due to the combination of Elasticity of the covering, characteristics of the interior construction and the design of the product.



Products with Visual Appearance listed as High or Medium would require higher degree of care, where seats and back cushions may require fluffing and plumping more often than Products with Visual Appearance listed as Low.

NOTES

- Designed by STUDIO BIG – Bjarke Ingels Group.
- Date of launch: 2023.
- Colle draws inspiration from the first Natuzzi models recognised worldwide for their soft and hospitable style. It's a key feature of this model that harmoniously portrays the relaxation typical of the Mediterranean life.  
The design is distinguished by the pleasant "wrinkles" that are created on the covering, which enhance the softness of the design and the sense of visual comfort.
- In leather the model is available starting from cat. 15 (Le Mans).
- Model also available with thick leather with model code Sxxx (Art. Cassidy cat.60, Misterbianco cat.30).
- Tone-on-tone edging along the profile of each individual module that emphasizes its roundness and enhances its design.
- Seat cushion includes a layer of memory foam, a pressure-sensitive soft polyurethane, that recovers its form completely thus giving great comfort.
- Internal plywood frame, elastic straps under the seat cushions and on the backrest.
- Removable hooks on each seating module.
- Smoked ash exposed structure (ST12).

## NOTES

---

- The wooden base with anti-scratch and non-slip rubbers offer a practical solution for protecting floors.  
Wooden base requires assembling and it is located in an envelope inside the package  
Base height 8 cm.



■ Vers. 009



■ Vers. 009+251+250+251+250

## SCHEMATICS

---

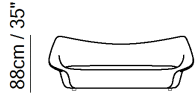

009

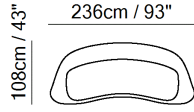

009



251

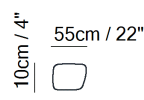

251

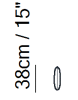







250



250

TECHNICAL INFORMATION

	<b>COVERING</b>	Leather <input checked="" type="checkbox"/>	Soft Cover <input checked="" type="checkbox"/>			
	<b>FILLING</b>	Arms <input type="checkbox"/> Fiber <input checked="" type="checkbox"/> Foam <input type="checkbox"/> Feather/Fiber Mix <input type="checkbox"/> Feather	Seat cushion <input type="checkbox"/> Fiber <input checked="" type="checkbox"/> Foam <input type="checkbox"/> Feather/Fiber Mix <input type="checkbox"/> Feather	Back cushion <input type="checkbox"/> Fiber <input checked="" type="checkbox"/> Foam <input type="checkbox"/> Feather/Fiber Mix <input type="checkbox"/> Feather		
	<b>COMFORT</b>	Standard Comfort <input checked="" type="checkbox"/>	Firm Comfort <input type="checkbox"/>			
	<b>FUNCTION</b>	Bed <input type="checkbox"/>	Electric motion <input type="checkbox"/>	Motion <input type="checkbox"/>	Recliner <input type="checkbox"/>	Sliding <input type="checkbox"/>
	<b>VISUAL APPEARANCE*</b>	Low <input checked="" type="checkbox"/>	Medium <input type="checkbox"/>	High <input type="checkbox"/>		
	<b>LEGS</b>	Wood <input type="checkbox"/>	Metal <input checked="" type="checkbox"/>	Plastic <input type="checkbox"/>	Castors <input type="checkbox"/>	Upholstered <input type="checkbox"/>

VISUAL APPEARANCE

The product may reveal various wrinkles due to the combination of Elasticity of the covering, characteristics of the interior construction and the design of the product.



Products with Visual Appearance listed as High or Medium would require higher degree of care, where seats and back cushions may require fluffing and plumping more often than Products with Visual Appearance listed as Low.

NOTES

- Designed by Enrique Marti.
- Date of launch: 2023.
- Splash is about stopping time, that moment of rest in which absolutely nothing happens but gives us an instant of great well-being. As if one presses the pause button at the precise moment when a drop of water falls on a surface and jumps. This creates curved upward arms, as if enveloping or embracing those who sit on it.
- Available in leather or fabric.
- In leather, model is available starting from cat. 30.
- Model is not available with article Misterbianco (cat. 30).
- Cushions available tone on tone or contrast.
- Internal metal frame covered with differentiated density polyurethane to provide support on the backrest (50) and softness on the seat (40).
- Seat frame is made of plywood and has elastic straps to ensure maximum comfort.
- The hidden metal feet with anti-scratch and non-slip rubbers offer a practical solution for protecting floors.
- Feet will be in a bag inside the package and requires assembling.
- Feet height 4cm.

NOTES

---



■ Vers. 715+716+238+208



■ Vers. 072+076+274



■ Vers. 272+032+291+049



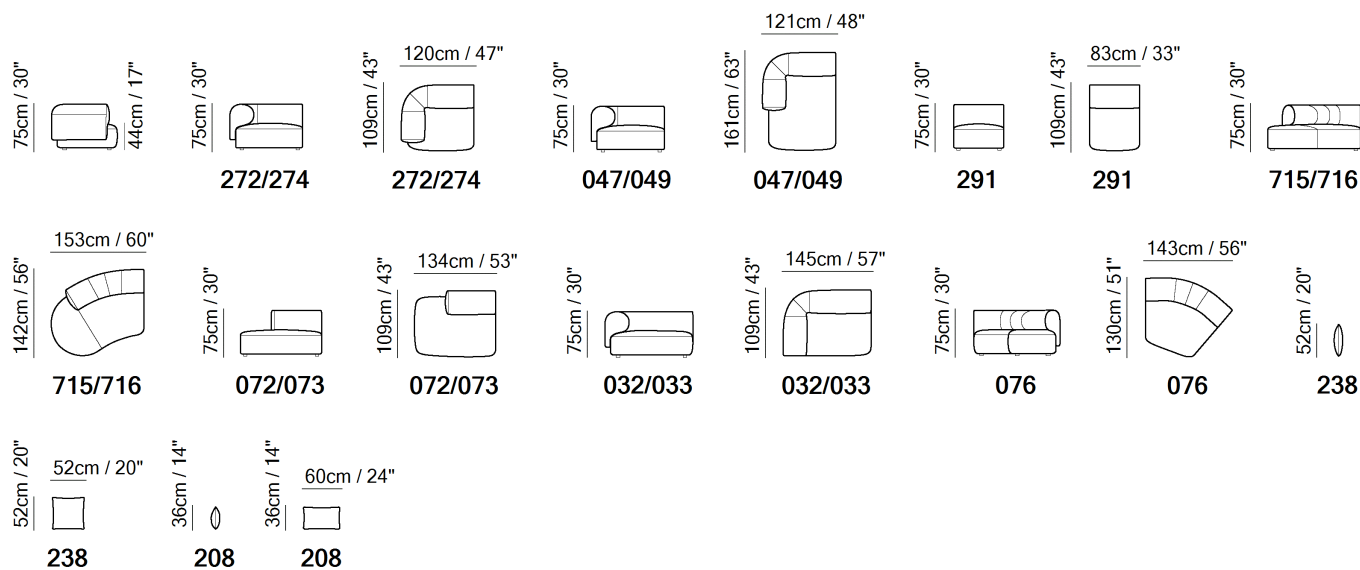

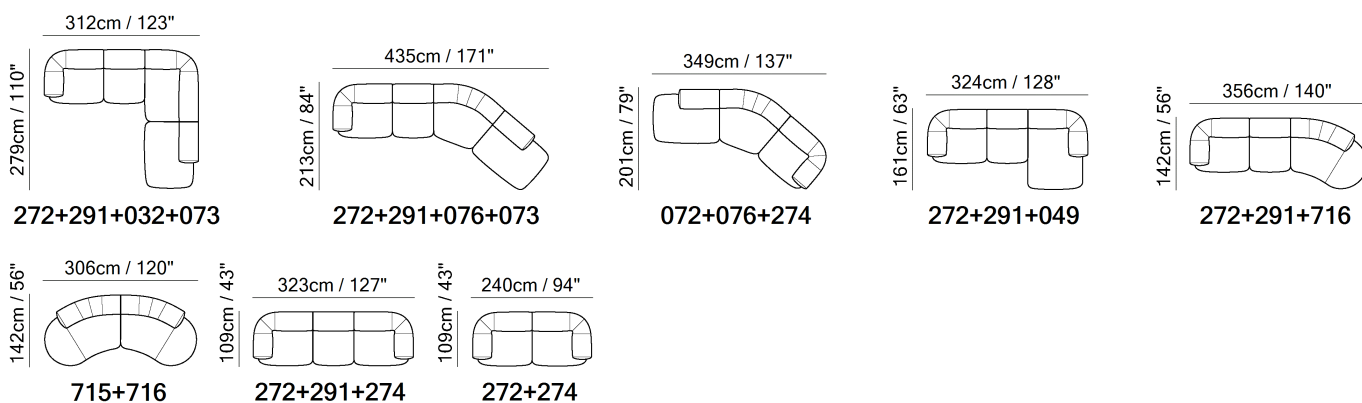

## SCHEMATICS



## COMPOSITION EXAMPLES



TECHNICAL INFORMATION

	<b>COVERING</b>	Leather <input checked="" type="checkbox"/>	Soft Cover <input checked="" type="checkbox"/>				
	<b>FILLING</b>	Arms	<input type="checkbox"/> Fiber <input checked="" type="checkbox"/> Foam <input type="checkbox"/> Feather/Fiber Mix <input type="checkbox"/> Feather	Seat cushion	<input type="checkbox"/> Fiber <input checked="" type="checkbox"/> Foam <input type="checkbox"/> Feather/Fiber Mix <input type="checkbox"/> Feather	Back cushion	<input type="checkbox"/> Fiber <input checked="" type="checkbox"/> Foam <input type="checkbox"/> Feather/Fiber Mix <input type="checkbox"/> Feather
	<b>COMFORT</b>	Standard Comfort <input checked="" type="checkbox"/>	Firm Comfort <input type="checkbox"/>				
	<b>FUNCTION</b>	Bed <input type="checkbox"/>	Electric motion <input type="checkbox"/>	Motion <input type="checkbox"/>	Recliner <input type="checkbox"/>	Sliding <input type="checkbox"/>	
	<b>VISUAL APPEARANCE*</b>	Low <input checked="" type="checkbox"/>	Medium <input type="checkbox"/>	High <input type="checkbox"/>			
	<b>LEGS</b>	Wood <input type="checkbox"/>	Plastic <input type="checkbox"/>	Metal <input checked="" type="checkbox"/>	Upholstered <input type="checkbox"/>	Castors <input type="checkbox"/>	

VISUAL APPEARANCE

The product may reveal various wrinkles due to the combination of Elasticity of the covering, characteristics of the interior construction and the design of the product.



Products with Visual Appearance listed as High or Medium would require higher degree of care, where seats and back cushions may require fluffing and plumping more often than Products with Visual Appearance listed as Low.

NOTES

- Designed by Simone Bonanni Studio.
- Date of launch: 2023.
- Available in leather or fabric.
- In leather the model is available starting from cat. 15 (Le Mans).
- Model is not available with article Misterbianco (cat. 30).
- Tone-on-tone edging along the profile of each individual module that emphasizes its roundness and enhances its design.
- Seat and back cushion composed of polyurethane foam in different densities: firmer on the seat and softer on the back.
- Versions 238 and 208: Optional cushions in two different sizes and shapes can be ordered in leather and fabric.
- Versions 715 and 716: End elements with organic shapes.
- Internal plywood frame, elastic straps under the seat cushions and on the backrest.
- Upholstered sofa sides with hidden and removable hooks
- Feet will be in a bag inside the package and requires assembling.
- The hidden metal feet with anti-scratch and non-slip rubbers offer a practical solution for protecting floors.

## NOTES

---

- Feet height 4 cm.



■ Vers. N00+N25+N02



■ Vers. N46



■ Vers. 000+001+076+002



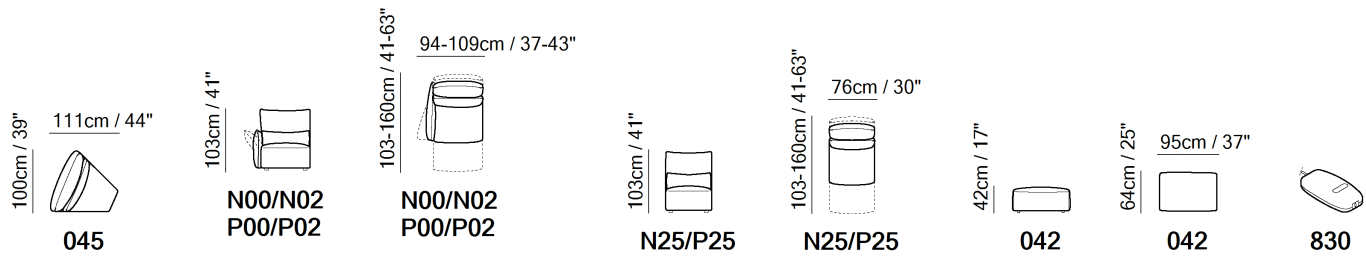
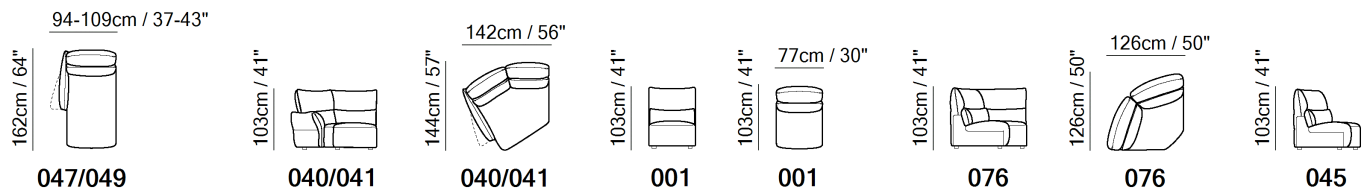
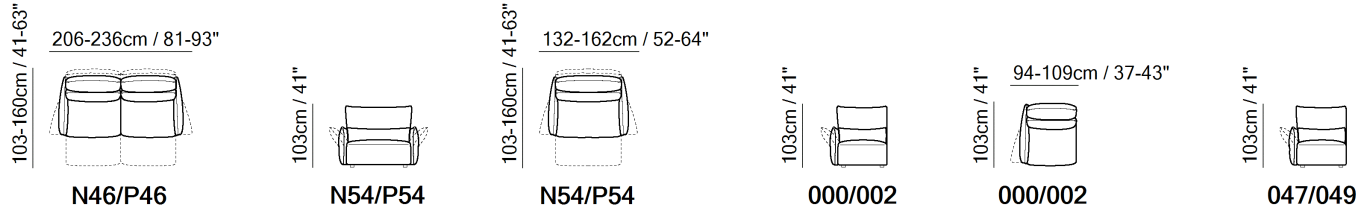
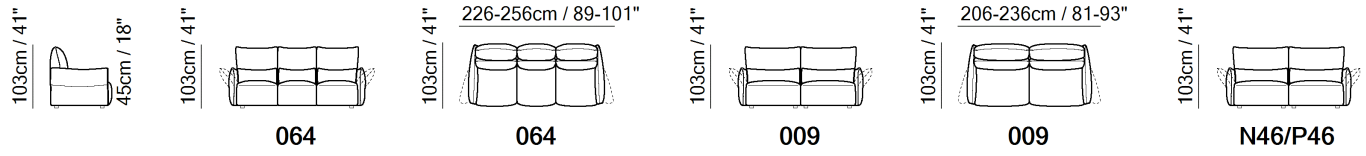

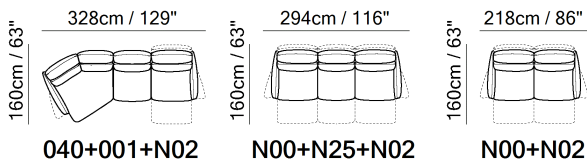
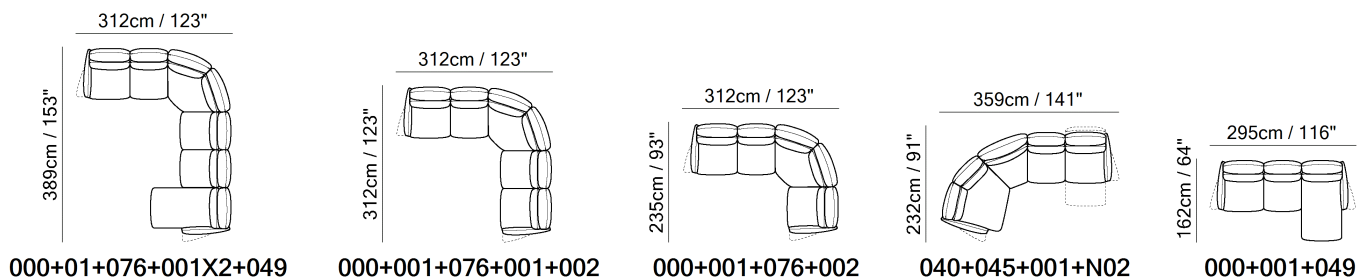

SCHEMATICS



COMPOSITION EXAMPLES



TECHNICAL INFORMATION

	<b>COVERING</b>	Leather <input checked="" type="checkbox"/>	Soft Cover <input checked="" type="checkbox"/>				
	<b>FILLING</b>	Arms	<input type="checkbox"/> Fiber <input checked="" type="checkbox"/> Foam <input type="checkbox"/> Feather/Fiber Mix <input type="checkbox"/> Feather	Seat cushion	<input type="checkbox"/> Fiber <input checked="" type="checkbox"/> Foam <input type="checkbox"/> Feather/Fiber Mix <input type="checkbox"/> Feather	Back cushion	<input type="checkbox"/> Fiber <input checked="" type="checkbox"/> Foam <input type="checkbox"/> Feather/Fiber Mix <input type="checkbox"/> Feather
	<b>COMFORT</b>	Standard Comfort <input checked="" type="checkbox"/>	Firm Comfort <input type="checkbox"/>				
	<b>FUNCTION</b>	Bed <input type="checkbox"/>	Electric motion <input checked="" type="checkbox"/>	Motion <input checked="" type="checkbox"/>	Recliner <input checked="" type="checkbox"/>	Sliding <input type="checkbox"/>	
	<b>VISUAL APPEARANCE*</b>	Low <input type="checkbox"/>	Medium <input type="checkbox"/>	High <input checked="" type="checkbox"/>			
	<b>LEGS</b>	Wood <input type="checkbox"/>	Metal <input checked="" type="checkbox"/>	Plastic <input type="checkbox"/>	Castors <input type="checkbox"/>	Upholstered <input type="checkbox"/>	

VISUAL APPEARANCE

The product may reveal various wrinkles due to the combination of Elasticity of the covering, characteristics of the interior construction and the design of the product.



Products with Visual Appearance listed as High or Medium would require higher degree of care, where seats and back cushions may require fluffing and plumping more often than Products with Visual Appearance listed as Low.

NOTES

- Designed by Natuzzi Design Center.
- Date of launch: 2023.
- A never ending relax.  
A modular system that brings together the brand's key features, such as comfort and functionality, updating them in a contemporary and versatile design.  
The wide abacus allows the creation of countless configurations suitable for all needs and spaces.
- In leather the model is available starting from cat. 15 (Le Mans).
- Model is not available with article Misterbianco (cat. 30).
- Thin-profile armrest with pillow shape also on backrest. To reinforce this concept, the band running around the entire perimeter of the sofa can be tone-on-tone or contrasting.
- Model can be ordered as follows:
  1. In leather, single covering;
  2. In leather, with leather piping chosen between Lemans (cat. 15) and Stromboli (cat. 30);
  3. In fabric, single covering;
  4. In fabric, with leather piping chosen between Lemans (cat. 15) and Stromboli (cat. 30).
- Seat and back cushion composed of polyurethane foam in different densities: firmer on the seat and softer on the back.
- Relax function with triple motion mechanism.  
Triple motion mechanism activates footrest, headrest and lumbar support.

## NOTES

---

- Wellbe has a "home" button that resets from the relax position to the original position all in one movement. The "home" button is the first of the three switches and is activated by continuous pressure.
- On the armrest there is a button to activate and deactivate the recliner mechanism.
- Vers. P00-P02-P25-P46-P54: possibility to activate the recliner function also via downloadable APP.
- The armless chair has buttons on the right side of the seat.
- Flexible armrest in the front with storage pocket.
- Built in USB C cable plug with charging capacity. Available only for motion versions.
- Equipped with satin label that is intended to indicate the position of the control panel.
- Lovechair has a recliner.
- The corner module has been designed with a wedge to improve its comfort and provide better functionality without compromising the design.
- Seats come in 3 different width:
  - N46-009 wide seat;
  - N00/N02-000/002-001-N25 medium seat;
  - 064 small seat.
- A battery pack can be ordered with its own version code 830. For order entry please use XX for category and XXX for cover code. In order to optimize the duration of the battery, it is suggested to order one per each motion seat.
- Internal wooden frame.
- Hooks on each seat.
- No upholstered side.
- The hidden metal feet with anti-scratch and non-slip rubbers offer a practical solution for protecting floors.
- Feet will be in a bag inside the package and requires assembling.
- Feet height 4 cm.



■ Vers. 450+274



■ Vers. 450+274



■ Vers. 450+291+274



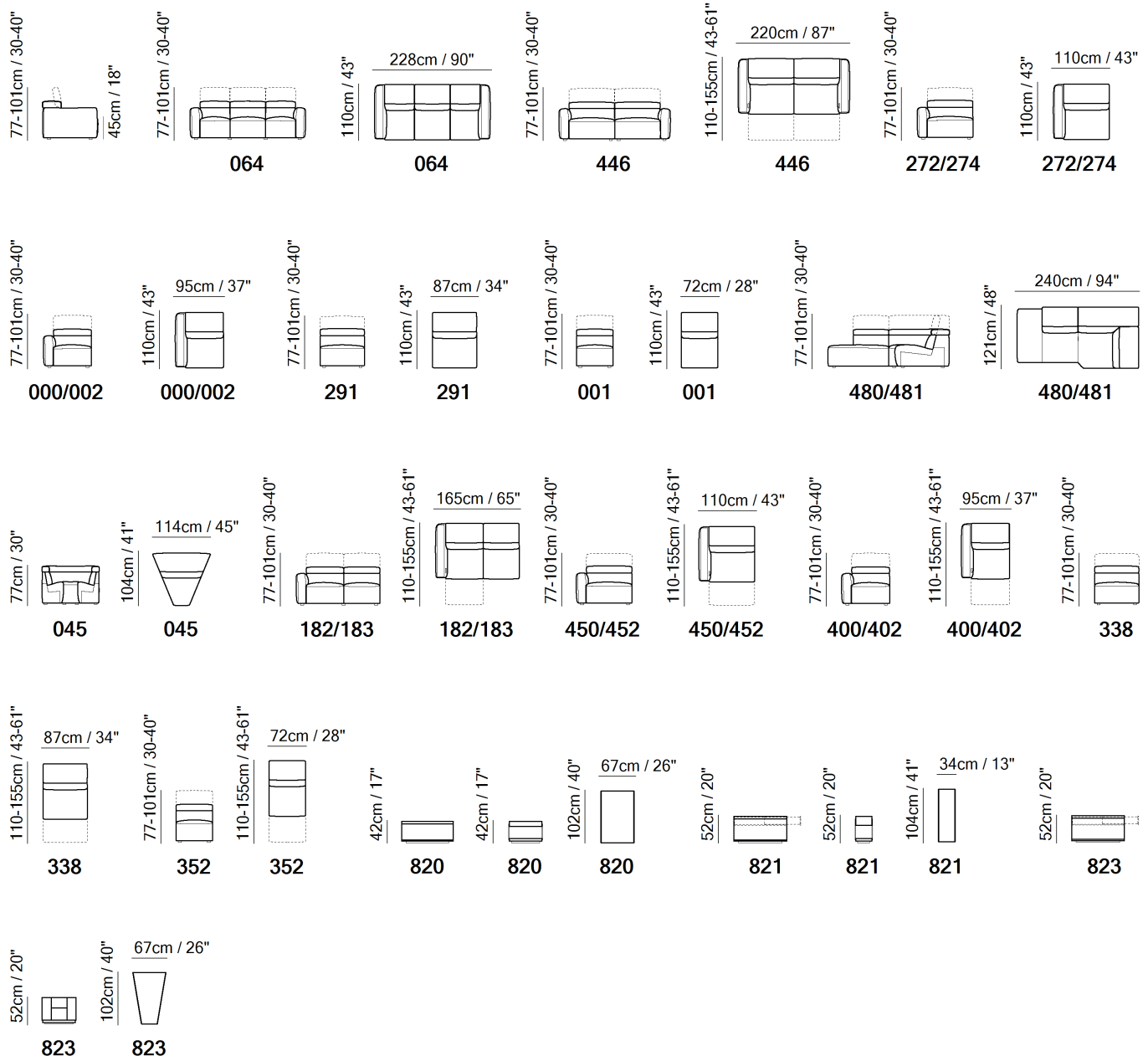

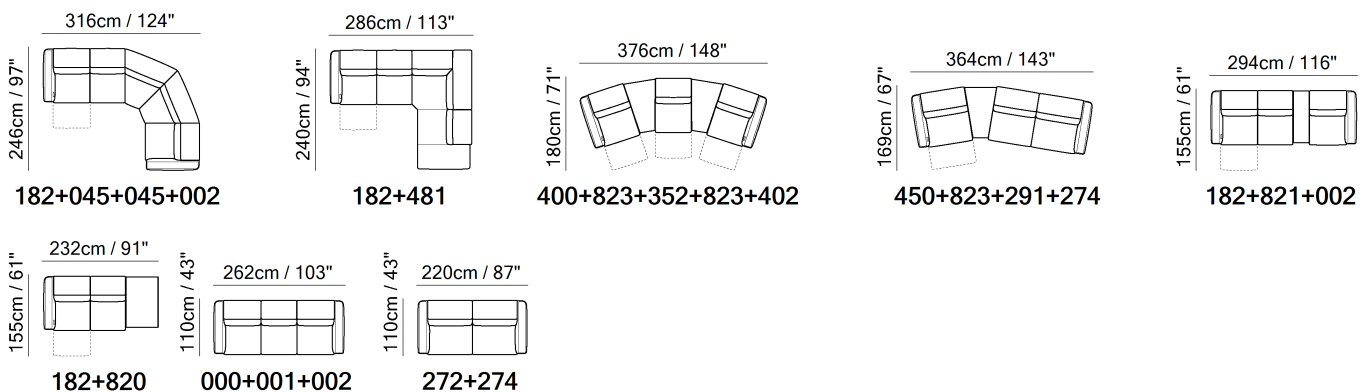

**SCHEMATICS**



**COMPOSITION EXAMPLES**



TECHNICAL INFORMATION

	<b>COVERING</b>	Leather <input checked="" type="checkbox"/>	Soft Cover <input checked="" type="checkbox"/>			
	<b>FILLING</b>	Arms <input type="checkbox"/> Fiber <input checked="" type="checkbox"/> Foam <input type="checkbox"/> Feather/Fiber Mix <input type="checkbox"/> Feather	Seat cushion <input type="checkbox"/> Fiber <input checked="" type="checkbox"/> Foam <input type="checkbox"/> Feather/Fiber Mix <input type="checkbox"/> Feather	Back cushion <input type="checkbox"/> Fiber <input checked="" type="checkbox"/> Foam <input type="checkbox"/> Feather/Fiber Mix <input type="checkbox"/> Feather		
	<b>COMFORT</b>	Standard Comfort <input checked="" type="checkbox"/>	Firm Comfort <input type="checkbox"/>			
	<b>FUNCTION</b>	Bed <input type="checkbox"/>	Electric motion <input checked="" type="checkbox"/>	Motion <input checked="" type="checkbox"/>	Recliner <input type="checkbox"/>	Sliding <input type="checkbox"/>
	<b>VISUAL APPEARANCE*</b>	Low <input type="checkbox"/>	Medium <input checked="" type="checkbox"/>	High <input type="checkbox"/>		
	<b>LEGS</b>	Wood <input type="checkbox"/>	Plastic <input type="checkbox"/>	Metal <input type="checkbox"/>	Upholstered <input type="checkbox"/>	Castors <input type="checkbox"/>

VISUAL APPEARANCE

The product may reveal various wrinkles due to the combination of Elasticity of the covering, characteristics of the interior construction and the design of the product.



Products with Visual Appearance listed as High or Medium would require higher degree of care, where seats and back cushions may require fluffing and plumping more often than Products with Visual Appearance listed as Low.

NOTES

- Designed by Natuzzi Design Center.
- Date of launch: 2024.
- Introducing the new Domus sofa, the model draws inspiration from the Roman Domus, the heart of daily life. This design embodies the essence of comfort and elegance, reflecting the central role that the Domus played in ancient Roman households.
- Available in leather or fabric.
- When the model is in fabric: the first covering is the main fabric where the second covering is the contrast leather piping available in CAT 15 Le Mans, CAT 30 Stromboli, CAT 40 Siena.
- Model is not available with article Misterbianco (cat. 30).
- It offers both motion recliner and non-recliner modules.
- The mechanism of the sofa with a dual motor recliner is very intuitive. With the two buttons on the front part of the control panel, the headrest opens first simultaneously, and once opened, the footrest opens.
- The two buttons on the inner part of the control panel, towards the backrest, allow you to individually control the position of the headrest, tilting it further and bringing it to a more advanced position. This provides better comfort when watching TV, reading a book, or relaxing.

## NOTES

---

- By distributing weight evenly across all pressure points, the zero-gravity power motion system makes you feel weightless. It takes the pressure off your spine and can promote circulation in the legs.  
The definition of Zero Gravity Reclining is the ability for your heart to be resting above your feet which provides proven health benefits.
- The Domus sofa is also available with a 45-degree corner option and terminal. It also includes in between seat console and table tops, rectangular or trapezoidal, complete with storage compartments
- The Domus Sofa is complemented by versatile table tops vers. 820, 821, 823. They are available in three elegant wood finishes: smoked oak (ST32), ash grey oak (ST23), and walnut finish (ST39).
- These table tops come in two shapes: rectangular and trapezoidal. The rectangular table tops (vers. 820,821) offer the flexibility of being available with or without drawer storage, while the trapezoidal table top (vers. 823) include drawer storage.  
Designed for adaptability, these table tops can be seamlessly integrated between the seats or positioned at the end of an armless sofa composition, enhancing both functionality and aesthetic appeal.



■ Vers. 216+045+274



■ Vers. 216+045+274



■ Vers. 216+045+274



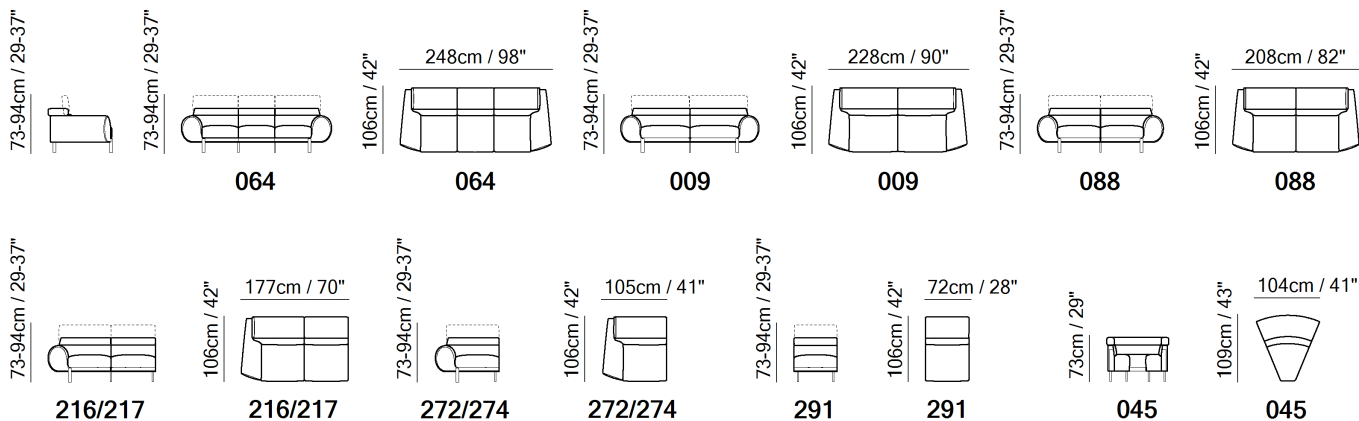

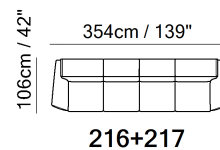
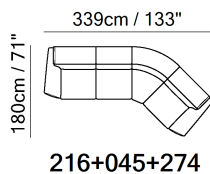
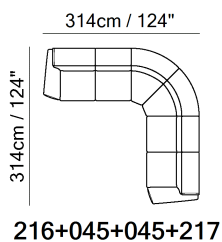

**SCHEMATICS**



**COMPOSITION EXAMPLES**



TECHNICAL INFORMATION

	<b>COVERING</b>	Leather <input checked="" type="checkbox"/>	Soft Cover <input checked="" type="checkbox"/>			
	<b>FILLING</b>	Arms <input type="checkbox"/> Fiber <input checked="" type="checkbox"/> Foam <input type="checkbox"/> Feather/Fiber Mix <input type="checkbox"/> Feather	Seat cushion <input type="checkbox"/> Fiber <input checked="" type="checkbox"/> Foam <input type="checkbox"/> Feather/Fiber Mix <input type="checkbox"/> Feather	Back cushion <input type="checkbox"/> Fiber <input checked="" type="checkbox"/> Foam <input type="checkbox"/> Feather/Fiber Mix <input type="checkbox"/> Feather		
	<b>COMFORT</b>	Standard Comfort <input checked="" type="checkbox"/>	Firm Comfort <input type="checkbox"/>			
	<b>FUNCTION</b>	Bed <input type="checkbox"/>	Electric motion <input type="checkbox"/>	Motion <input type="checkbox"/>	Recliner <input type="checkbox"/>	Sliding <input type="checkbox"/>
	<b>VISUAL APPEARANCE*</b>	Low <input checked="" type="checkbox"/>	Medium <input type="checkbox"/>	High <input type="checkbox"/>		
	<b>LEGS</b>	Wood <input type="checkbox"/>	Metal <input type="checkbox"/>	Plastic <input type="checkbox"/>	Castors <input type="checkbox"/>	Upholstered <input type="checkbox"/>

VISUAL APPEARANCE

The product may reveal various wrinkles due to the combination of Elasticity of the covering, characteristics of the interior construction and the design of the product.



Products with Visual Appearance listed as High or Medium would require higher degree of care, where seats and back cushions may require fluffing and plumping more often than Products with Visual Appearance listed as Low.

NOTES

- Designed by Natuzzi Design Center.
- Date of launch: 2024.
- Introducing the epitome of minimalist elegance. Plutone it serves as a reminder that true beauty lies in the purity of simplicity. Inspired by the vast expanse of space, this sofa encapsulates the essence of modern sophistication.
- Available in leather or fabric.
- In leather the model is available starting from cat. 15 (Le Mans).
- Model is not available with article Misterbianco (cat. 30).
- Modular sofa available in linear and sectional versions with a 45° corner.
- Adjustable headrest on all versions except for corner version 045.
- Hooks on modular seats.
- Feet available in metal finishings 74 (Graphite Grey Rough) / 79 (Matt Black).

NOTES

---



■ Vers. 727+728



■ Vers. 727+728



■ Vers. 727+761+790+761+728



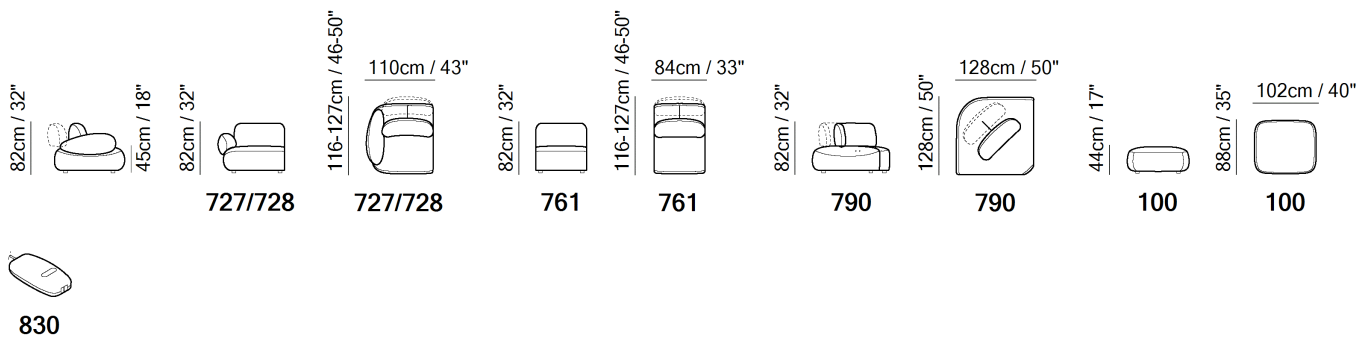

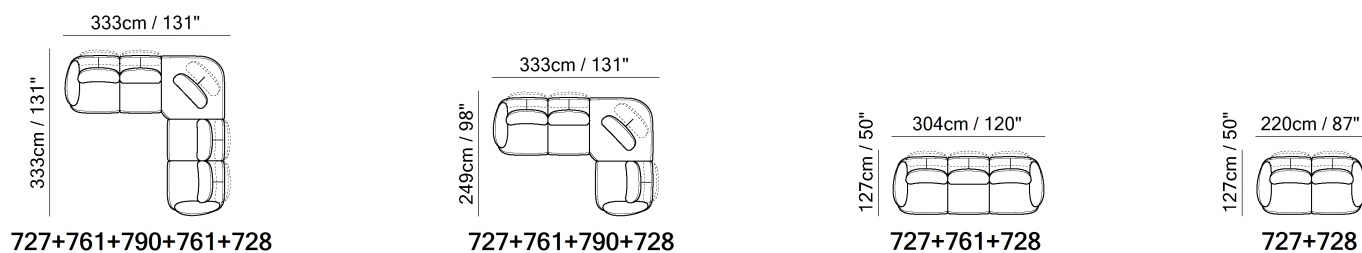

## SCHEMATICS



## COMPOSITION EXAMPLES



TECHNICAL INFORMATION

	<b>COVERING</b>	Leather <input checked="" type="checkbox"/>	Soft Cover <input checked="" type="checkbox"/>			
	<b>FILLING</b>	Arms <input type="checkbox"/> Fiber <input checked="" type="checkbox"/> Foam <input type="checkbox"/> Feather/Fiber Mix <input type="checkbox"/> Feather	Seat cushion <input type="checkbox"/> Fiber <input checked="" type="checkbox"/> Foam <input type="checkbox"/> Feather/Fiber Mix <input type="checkbox"/> Feather	Back cushion <input type="checkbox"/> Fiber <input checked="" type="checkbox"/> Foam <input type="checkbox"/> Feather/Fiber Mix <input type="checkbox"/> Feather		
	<b>COMFORT</b>	Standard Comfort <input checked="" type="checkbox"/>	Firm Comfort <input type="checkbox"/>			
	<b>FUNCTION</b>	Bed <input type="checkbox"/>	Electric motion <input type="checkbox"/>	Motion <input type="checkbox"/>	Recliner <input type="checkbox"/>	Sliding <input type="checkbox"/>
	<b>VISUAL APPEARANCE*</b>	Low <input checked="" type="checkbox"/>	Medium <input type="checkbox"/>	High <input type="checkbox"/>		
	<b>LEGS</b>	Wood <input type="checkbox"/>	Plastic <input type="checkbox"/>	Metal <input checked="" type="checkbox"/>	Upholstered <input type="checkbox"/>	Castors <input type="checkbox"/>

VISUAL APPEARANCE

The product may reveal various wrinkles due to the combination of Elasticity of the covering, characteristics of the interior construction and the design of the product.



Products with Visual Appearance listed as High or Medium would require higher degree of care, where seats and back cushions may require fluffing and plumping more often than Products with Visual Appearance listed as Low.

NOTES

- Designed by Natuzzi Design Center.
- Date of launch: 2024.
- With its unique design, Snail captures the elegance and functionality of nature. Its side shape is reminiscent of the elegant silhouette of a snail, while the translating backrest emulates the fluid and reassuring movement of a snail retracting into its shell.
- Available in leather or fabric.
- In leather the model is available starting from cat. 15 (Le Mans).
- Model is not available with article Misterbianco (cat. 30).
- The piping running around the entire perimeter of the sofa can be tone-on-tone in the same leather or in contrast when in fabric. If the main covering chosen is fabric the contrast piping can be done in leather CAT 15 Le Mans, CAT 25 Status, CAT 30 Stromboli e CAT 40 Siena.
- A sliding mechanism on all modules allows the backrest to be shifted by approx 400 mm, so as to have customized comfort modifying the seat depth from approx 60cm to 100cm. This allows the seat to be used as a casual seat or as a compact chaise longue.
- Available with Soft Touch mechanism that customize the back cushion depth with a tap. The buttons are positioned on the internal side of the arm for versions 727/728 and on the internal right side of the seat for versions 761/790.
- A battery pack can be ordered with its own version code 830. For order entry please use XX for category and XXX for cover code. In order to optimize the duration of the battery, it is suggested to order one per each motion seat.

## NOTES

---

- The battery pack has to be connected to the back of the chair by removing the power supply cable. It is strongly recommended to order one battery bank per motion seat in order to guarantee a long life.
- Upholstered side
- Removable hooks on each seating module.
- The hidden metal feet with anti-scratch and non-slip rubbers offer a practical solution for protecting floors.



■ Vers. Q00+Q02



■ Vers. Q00+Q25+Q02



■ Vers. Q00+045+823+Q25+817



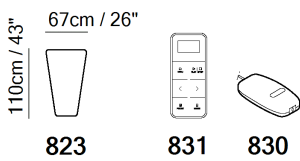
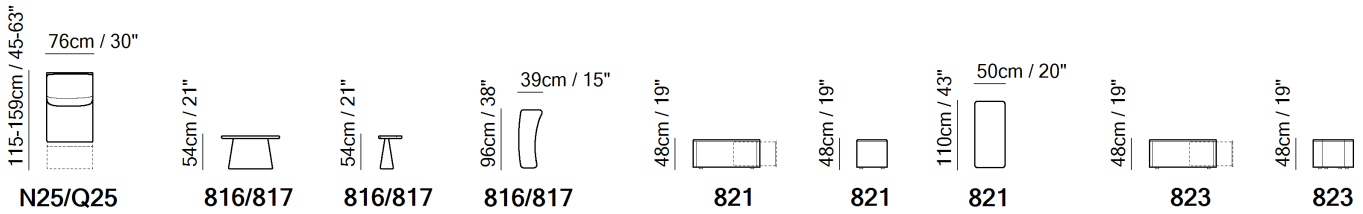
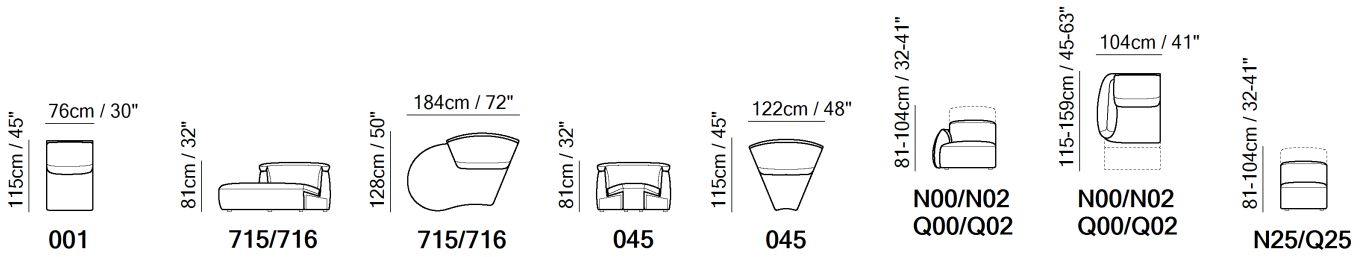
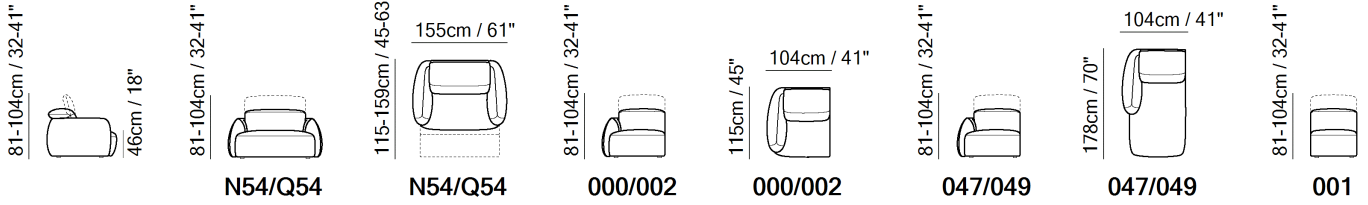

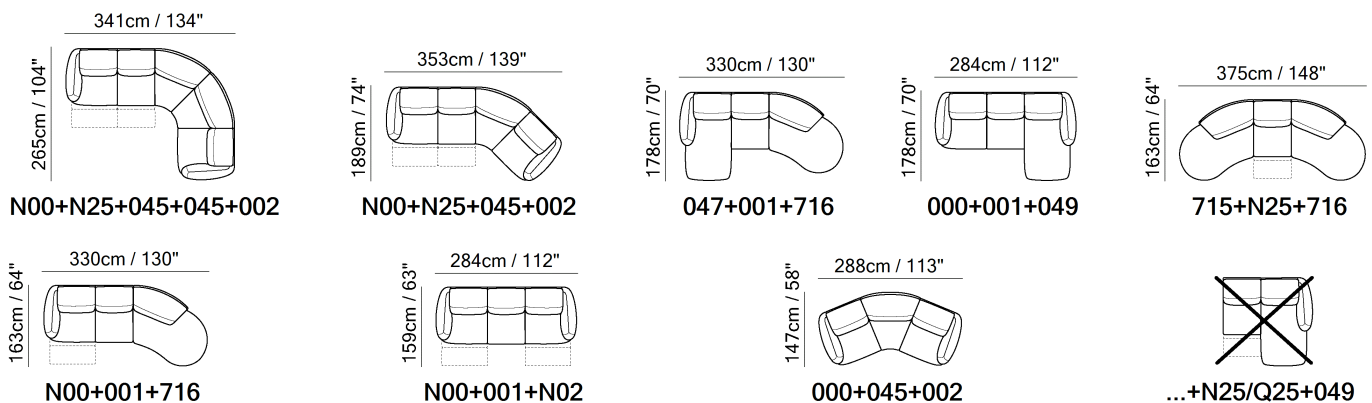

SCHEMATICS



COMPOSITION EXAMPLES



TECHNICAL INFORMATION

	<b>COVERING</b>	Leather <input checked="" type="checkbox"/>	Soft Cover <input checked="" type="checkbox"/>			
	<b>FILLING</b>	Arms <input type="checkbox"/> Fiber <input checked="" type="checkbox"/> Foam <input type="checkbox"/> Feather/Fiber Mix <input type="checkbox"/> Feather	Seat cushion <input type="checkbox"/> Fiber <input checked="" type="checkbox"/> Foam <input type="checkbox"/> Feather/Fiber Mix <input type="checkbox"/> Feather	Back cushion <input type="checkbox"/> Fiber <input checked="" type="checkbox"/> Foam <input type="checkbox"/> Feather/Fiber Mix <input type="checkbox"/> Feather		
	<b>COMFORT</b>	Standard Comfort <input checked="" type="checkbox"/>	Firm Comfort <input type="checkbox"/>			
	<b>FUNCTION</b>	Bed <input type="checkbox"/>	Electric motion <input checked="" type="checkbox"/>	Motion <input checked="" type="checkbox"/>	Recliner <input checked="" type="checkbox"/>	Sliding <input type="checkbox"/>
	<b>VISUAL APPEARANCE*</b>	Low <input type="checkbox"/>	Medium <input type="checkbox"/>	High <input checked="" type="checkbox"/>		
	<b>LEGS</b>	Wood <input type="checkbox"/>	Metal <input type="checkbox"/>	Plastic <input type="checkbox"/>	Castors <input type="checkbox"/>	Upholstered <input type="checkbox"/>

VISUAL APPEARANCE

The product may reveal various wrinkles due to the combination of Elasticity of the covering, characteristics of the interior construction and the design of the product.



Products with Visual Appearance listed as High or Medium would require higher degree of care, where seats and back cushions may require fluffing and plumping more often than Products with Visual Appearance listed as Low.

NOTES

- Designed by Natuzzi Design Center.
- Date of launch: 2024.
- Mindful is a visionary sofa that transcends the ordinary. Inspired by the harmony of body movement, this masterpiece redefines the art of relaxation. Our designers and engineers have meticulously crafted a game changing sofa that for the first time combines in a single product all the latest innovations in motion technology.
- Available in leather or fabric.
- In leather the model is available starting from cat. 15 (Le Mans).
- Modular sofa available in linear and sectional versions with 45' Corner, Chaise Longue and round shaped terminal
- The corner module has been designed with a concave wedge to improve its comfort and provide better functionality without compromising the design.
- Complementary coffee tables and table top collection: Two stylish in-between seats side tables (vers. 821/823) seamlessly integrating with your seating arrangement while providing a chic table top, furthermore an organically shaped side armrest table (vers. 816/817). Available in upholstery price list.
- Central Coffee table with a convenient lift-up top, storage drawer and castors (Q083001XNA). Accent round side table allowing for versatile use (Q083002XNA). Both available in furnishing price list.
- Model is not available with article Misterbianco (cat. 30).

## NOTES

- Mindful's innovative mechanism enables 3 special functions: 365, Micromobility and triple motion with Zero Gravity.
- The leather insert (on the seat and backrest) and piping can be tone-on-tone or in contrast. If the main covering chosen is fabric the contrast piping can be done in leather CAT 15 Le Mans, Cat 25 Status, Cat 30 Stromboli or Cat 40 Siena.
- "365" and Micromobility functions are innovative regenerative systems, consisting of intelligent electronic mechanism activated via remote control. "365" helps to synchronize breathing with heartbeat and Micromobility gently stimulate body muscles.
- Function "365": activated through preset button on the remote control. The function triggers the movement of the headrest and lumbar to arch the back and facilitate synchronization of breath and heartbeat. It is suggested to perform 3 times a day, with 6 breaths per minute for 5 minutes per session. This process helps practicing synchronization of breathing with heartbeats, reducing stress.
- Function "Micromobility" activated through preset button on the remote control. The function can be started only once Zero Gravity is reached by triple motion. Once function is on, the sofa moves imperceptibly. It acts by slowly tilting seat and footrest simultaneously with micro movements, that, while the user is in a resting position, keeps muscles active improving blood circulation, contributing to a state of relaxation.
- Triple motion mechanism with independent control for headrest, lumbar and footrest.
- Zero Gravity is a reclining position activated through a triple motion mechanism. This position can be achieved through remote control (in QXX versions) or keypad (in QXX and NXX versions), by fully opening the seat and achieving full body extension, aligning the feet with the heart. This way, an optimal body position is reached, facilitating blood circulation. Zero Gravity is the starting position for Micromobility preset.
- All QXX versions beside Triple Motion/Zero Gravity, include "365" and Micromobility functions. "365" and Micromobility are exclusively operated by a remote control (sold separately, version 831). One remote control can manage up to 6 different seats separately.
- The NXX versions exclusively feature the Triple motion mechanism with Zero Gravity, which can only be activated via a keypad positioned on the inner side of the seat.
- Battery kit vers. 830 can be ordered as optional only for NXX versions. Please note that one battery can operate only one mechanism. Versions QXX cannot support battery kit.
- Versions 715/716/045 don't have adjustable headrest function. Electric headrest is available on versions NXX and QXX. Manual headrest is available on stationary versions.



■ Vers. 018+274



■ Vers. 018+045+045+274



■ Vers. 018+033+291+274



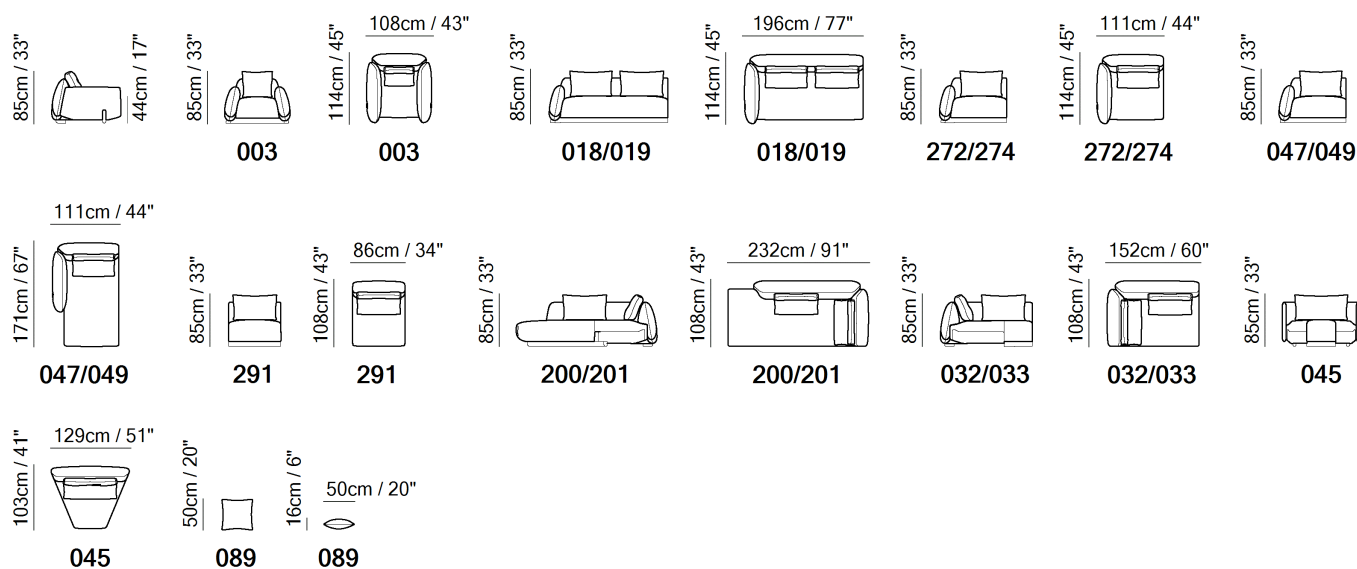

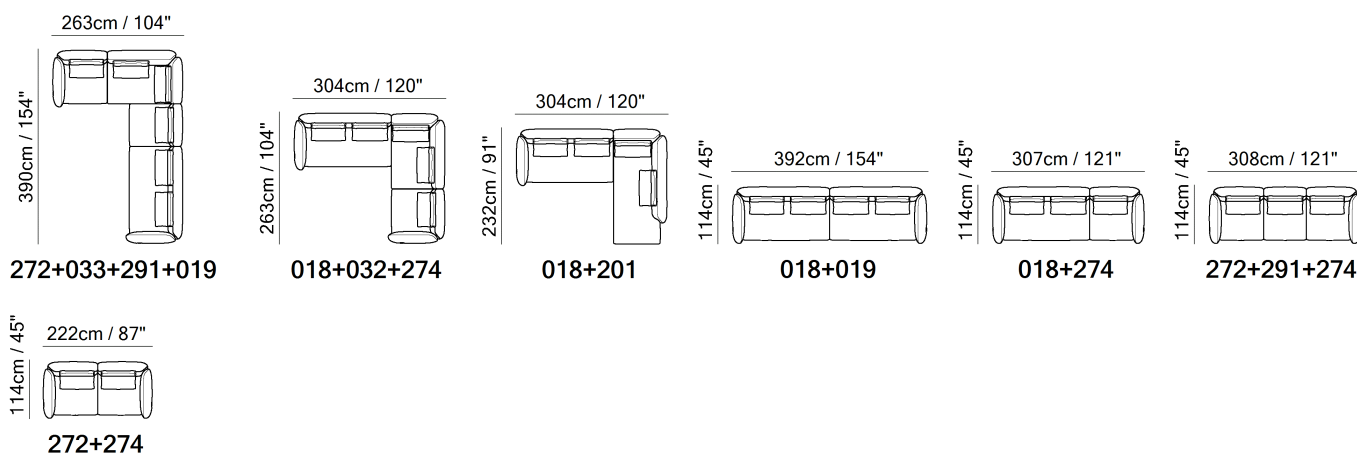

## SCHEMATICS



## COMPOSITION EXAMPLES



TECHNICAL INFORMATION

	<b>COVERING</b>	Leather <input checked="" type="checkbox"/>	Soft Cover <input checked="" type="checkbox"/>			
	<b>FILLING</b>	Arms <input type="checkbox"/> Fiber <input checked="" type="checkbox"/> Foam <input type="checkbox"/> Feather/Fiber Mix <input type="checkbox"/> Feather	Seat cushion <input type="checkbox"/> Fiber <input checked="" type="checkbox"/> Foam <input type="checkbox"/> Feather/Fiber Mix <input type="checkbox"/> Feather	Back cushion <input type="checkbox"/> Fiber <input checked="" type="checkbox"/> Foam <input type="checkbox"/> Feather/Fiber Mix <input type="checkbox"/> Feather		
	<b>COMFORT</b>	Standard Comfort <input checked="" type="checkbox"/>	Firm Comfort <input type="checkbox"/>			
	<b>FUNCTION</b>	Bed <input type="checkbox"/>	Electric motion <input type="checkbox"/>	Motion <input type="checkbox"/>	Recliner <input type="checkbox"/>	Sliding <input type="checkbox"/>
	<b>VISUAL APPEARANCE*</b>	Low <input checked="" type="checkbox"/>	Medium <input type="checkbox"/>	High <input type="checkbox"/>		
	<b>LEGS</b>	Wood <input type="checkbox"/>	Plastic <input type="checkbox"/>	Metal <input type="checkbox"/>	Upholstered <input type="checkbox"/>	Castors <input type="checkbox"/>

VISUAL APPEARANCE

The product may reveal various wrinkles due to the combination of Elasticity of the covering, characteristics of the interior construction and the design of the product.



Products with Visual Appearance listed as High or Medium would require higher degree of care, where seats and back cushions may require fluffing and plumping more often than Products with Visual Appearance listed as Low.

NOTES

- Designed by Andrea Steidl.
- Date of launch: 2024.
- For his new project in collaboration with Natuzzi Italia, Andrea Steidl draws inspiration from the 13th-century Federician architecture of Puglia. Like the grand Federician castles, Mirai possesses a structure with strong yet light personality, blending architectural depth with contemporary softness.
- Available in leather or fabric.
- In leather the model is available starting from cat. 25 (Status).
- Model is not available with article Misterbianco (cat. 30).
- Available in linear and modular versions, Mirai revolutionizes your living space with its futuristic aesthetic and customizable configurations. Its unique terminal modules(vers 200/201) and chaise longue (vers. 047/049) redefine versatility.
- Featuring rectangular back cushions filled with feather as standard fixed to the frame by a zip (except vers 003 where back cushion is loose). Mirai also offers the option to elevate your comfort with additional square cushions (vers 089), doubling as stylish accents. Embrace the future of relaxation with Mirai, where form meets function in perfect harmony.
- Leather Insert for all versions (except vers. 003)
- Sofa is available with leather insert that runs along the entire perimeter of the armrest and backrest.

NOTES

---

- For all versions except 003:  
When first covering is in leather, the insert is always in the colour of the first covering chosen.  
When first covering is in fabric, the insert can be ordered in any leather choosing from cat.15 Lemans, 25 Status, 30 Stromboli or 40 Siena.
- Leather Insert only for vers. 003 Armchair:
  - 1° Covering - Main armchair covering Leather or Fabric.
  - 2° Covering - Insert always in leather.When 1° Covering in Leather - Insert always in leather same leather as per main covering chosen.  
When 1° Covering in Fabric - Insert always leather tone on tone or contrast leather insert.  
Available in CAT 15 Le Mans, 25 Status, 30 Stromboli or 40 Siena.
- 3° Covering - Back cushion covering  
When 1° Covering in Leather - Back cushion covering always in leather tone on tone. Same leather as per main covering chosen.  
When 1° Covering in Fabric - Back cushion always Fabric Tone on tone or contrast. fabric.  
Available in any fabric categories.
- Seat cushions in high density polyurethane (35) with standard comfort.
- Upholstered side
- Removable hooks on each seating module.
- Feet available in wooden finishing 32 (Smoked Oak); 39 (European Walnut) and 44 (Ashwood Tobacco)



■ Vers. 032+033



■ Vers. 272+291+274



■ Vers. 272+202+578+291



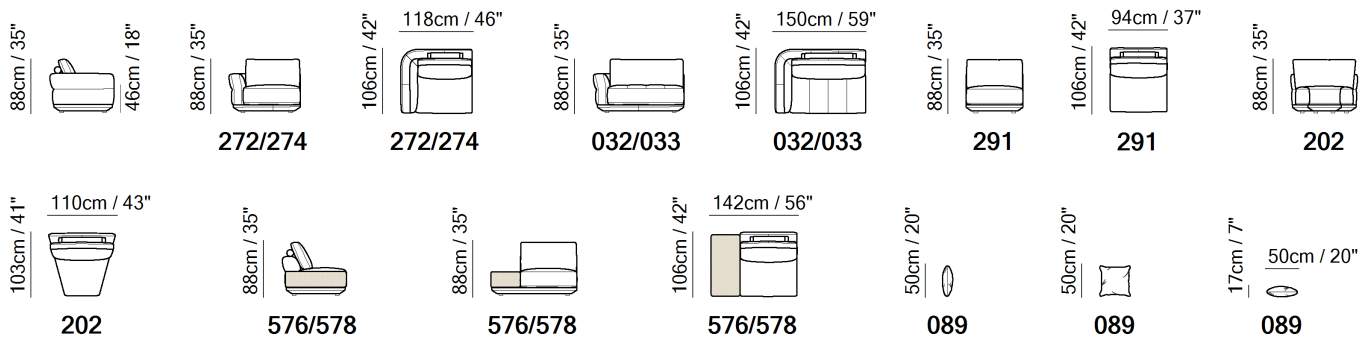

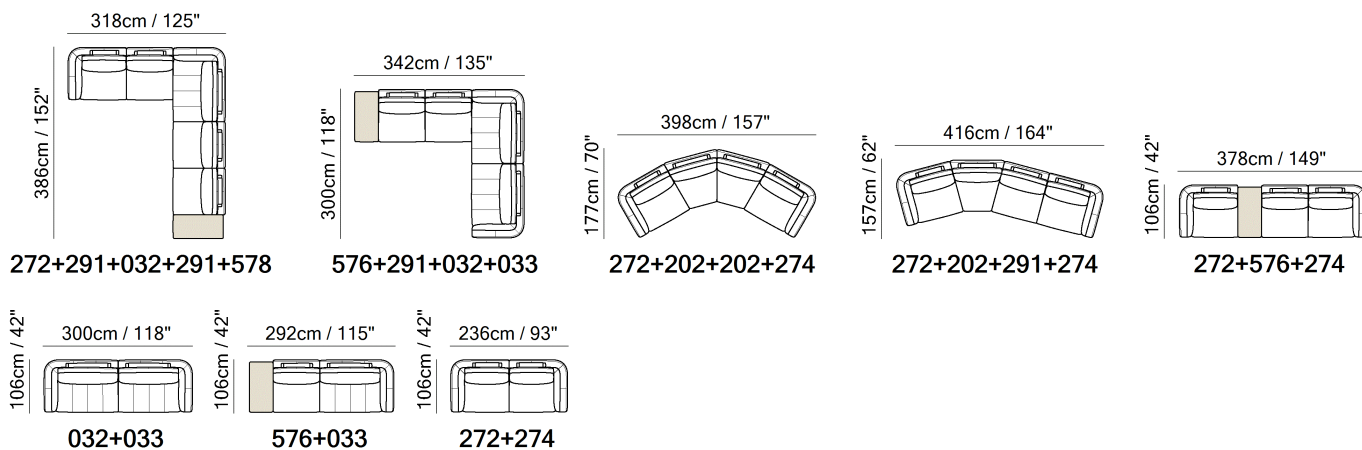

## SCHEMATICS



## COMPOSITION EXAMPLES



TECHNICAL INFORMATION

	<b>COVERING</b>	Leather <input checked="" type="checkbox"/>	Soft Cover <input checked="" type="checkbox"/>				
	<b>FILLING</b>	Arms	<input type="checkbox"/> Fiber <input checked="" type="checkbox"/> Foam <input type="checkbox"/> Feather/Fiber Mix <input checked="" type="checkbox"/> Feather	Seat cushion	<input type="checkbox"/> Fiber <input checked="" type="checkbox"/> Foam <input type="checkbox"/> Feather/Fiber Mix <input checked="" type="checkbox"/> Feather	Back cushion	<input type="checkbox"/> Fiber <input checked="" type="checkbox"/> Foam <input type="checkbox"/> Feather/Fiber Mix <input checked="" type="checkbox"/> Feather
	<b>COMFORT</b>	Standard Comfort <input checked="" type="checkbox"/>	Firm Comfort <input type="checkbox"/>				
	<b>FUNCTION</b>	Bed <input type="checkbox"/>	Electric motion <input type="checkbox"/>	Motion <input type="checkbox"/>	Recliner <input type="checkbox"/>	Sliding <input type="checkbox"/>	
	<b>VISUAL APPEARANCE*</b>	Low <input type="checkbox"/>	Medium <input checked="" type="checkbox"/>	High <input type="checkbox"/>			
	<b>LEGS</b>	Wood <input type="checkbox"/>	Metal <input type="checkbox"/>	Plastic <input type="checkbox"/>	Castors <input type="checkbox"/>	Upholstered <input type="checkbox"/>	

VISUAL APPEARANCE

The product may reveal various wrinkles due to the combination of Elasticity of the covering, characteristics of the interior construction and the design of the product.



Products with Visual Appearance listed as High or Medium would require higher degree of care, where seats and back cushions may require fluffing and plumping more often than Products with Visual Appearance listed as Low.

NOTES

- In leather the model is available starting from cat. 25 (Status).

NOTES

---



■ Vers. 291+291+291



■ Vers. 291+291+291+045+100



■ Vers. Q983+291+291+100



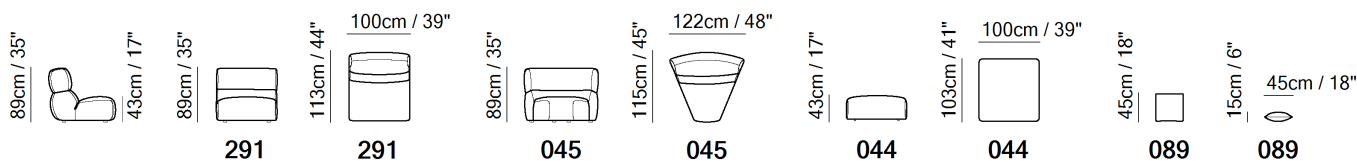

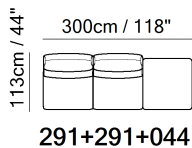
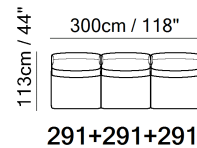
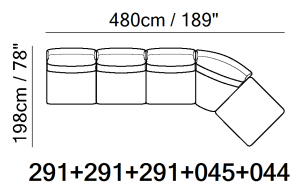
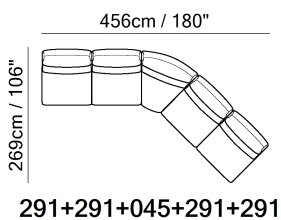
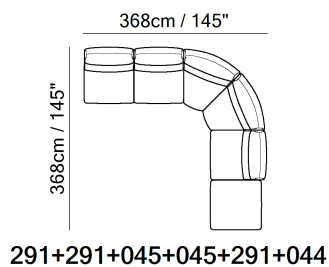

## SCHEMATICS



## COMPOSITION EXAMPLES



TECHNICAL INFORMATION

	<b>COVERING</b>	Leather <input checked="" type="checkbox"/>	Soft Cover <input checked="" type="checkbox"/>				
	<b>FILLING</b>	Arms	<input type="checkbox"/> Fiber <input checked="" type="checkbox"/> Foam <input type="checkbox"/> Feather/Fiber Mix <input type="checkbox"/> Feather	Seat cushion	<input type="checkbox"/> Fiber <input checked="" type="checkbox"/> Foam <input type="checkbox"/> Feather/Fiber Mix <input type="checkbox"/> Feather	Back cushion	<input type="checkbox"/> Fiber <input checked="" type="checkbox"/> Foam <input type="checkbox"/> Feather/Fiber Mix <input type="checkbox"/> Feather
	<b>COMFORT</b>	Standard Comfort <input checked="" type="checkbox"/>	Firm Comfort <input type="checkbox"/>				
	<b>FUNCTION</b>	Bed <input type="checkbox"/>	Electric motion <input type="checkbox"/>	Motion <input type="checkbox"/>	Recliner <input type="checkbox"/>	Sliding <input type="checkbox"/>	
	<b>VISUAL APPEARANCE*</b>	Low <input checked="" type="checkbox"/>	Medium <input type="checkbox"/>	High <input type="checkbox"/>			
	<b>LEGS</b>	Wood <input type="checkbox"/>	Plastic <input type="checkbox"/>	Metal <input checked="" type="checkbox"/>	Upholstered <input type="checkbox"/>	Castors <input type="checkbox"/>	

VISUAL APPEARANCE

The product may reveal various wrinkles due to the combination of Elasticity of the covering, characteristics of the interior construction and the design of the product.



Products with Visual Appearance listed as High or Medium would require higher degree of care, where seats and back cushions may require fluffing and plumping more often than Products with Visual Appearance listed as Low.

NOTES

- Designed by Simone Bonanni Studio.
- Date of launch: 2024.
- Momento has been designed and crafted as a modern and creative puzzle. Its layered composition evokes the dry stone walls typical of the Apulian countryside.
- Available in leather or fabric.
- In leather the model is available starting from cat. 25 (Status).
- Model is not available with article Misterbianco (cat. 30).
- Modular sofa available in linear and sectional versions with a 45° corner.
- Loose cushion vers. 089 can be ordered in different coverings and colors. It can be used as lumbar support or simply as decorative items.
- Ottoman vers. 044 is provided with hidden wheels.
- Complementary side table top in smoked oak (Q983001XNA). Available in furnishing pricelist.
- Upholstered side
- Seat frame is made of plywood and has elastic straps to ensure maximum comfort.
- The hidden metal feet with anti-scratch and non-slip rubbers offer a practical solution for protecting floors.

NOTES

---



■ Vers. 220+221









■ Vers. 272+291+029+217



■ Vers. 272+001+029+217



TECHNICAL INFORMATION

	<b>COVERING</b>	Leather <input checked="" type="checkbox"/>	Soft Cover <input checked="" type="checkbox"/>				
	<b>FILLING</b>	Arms	<input type="checkbox"/> Fiber <input checked="" type="checkbox"/> Foam <input type="checkbox"/> Feather/Fiber Mix <input type="checkbox"/> Feather	Seat cushion	<input type="checkbox"/> Fiber <input checked="" type="checkbox"/> Foam <input type="checkbox"/> Feather/Fiber Mix <input type="checkbox"/> Feather	Back cushion	<input type="checkbox"/> Fiber <input checked="" type="checkbox"/> Foam <input type="checkbox"/> Feather/Fiber Mix <input type="checkbox"/> Feather
	<b>COMFORT</b>	Standard Comfort <input checked="" type="checkbox"/>	Firm Comfort <input type="checkbox"/>				
	<b>FUNCTION</b>	Bed <input type="checkbox"/>	Electric motion <input type="checkbox"/>	Motion <input type="checkbox"/>	Recliner <input type="checkbox"/>	Sliding <input type="checkbox"/>	
	<b>VISUAL APPEARANCE*</b>	Low <input checked="" type="checkbox"/>	Medium <input type="checkbox"/>	High <input type="checkbox"/>			
	<b>LEGS</b>	Wood <input type="checkbox"/>	Metal <input checked="" type="checkbox"/>	Plastic <input type="checkbox"/>	Castors <input type="checkbox"/>	Upholstered <input type="checkbox"/>	

VISUAL APPEARANCE

The product may reveal various wrinkles due to the combination of Elasticity of the covering, characteristics of the interior construction and the design of the product.



Products with Visual Appearance listed as High or Medium would require higher degree of care, where seats and back cushions may require fluffing and plumping more often than Products with Visual Appearance listed as Low.

NOTES

- Designed by Karim Rashid.
- Date of launch: 2024.
- Memoria made of soft curves and sinuous lines, wants to emphasize the beauty of the encounter and the sweet fluidity of human relationships.
- Available in leather or fabric.
- In leather the model is available starting from cat. 25 (Status).
- Model also available with thick leather with model code Sxxx (Art. Cassidy cat.60, Misterbianco cat.30).
- Modular sofa available in linear and sectional versions with a soft and wavy corner (vers.029). Memoria is available with a sophisticated terminal version (vers. 220/221) and an organically sinuous three-seater with one arm version that provides 2 different seat depths (vers 216/217).
- Seat and back cushions in high density polyurethane foam.
- Upholstered side
- Removable hooks on each seating module.
- The hidden metal feet with anti-scratch and non-slip rubbers offer a practical solution for protecting floors.
- 4cm hidden metal feet with anti-scratch and non-slip rubbers.

NOTES

---



■ Vers. 223+291+045+291+223



■ Vers. 223+291+291+220+291+223



■ Vers. 223+291+291+223

## SCHEMATICS

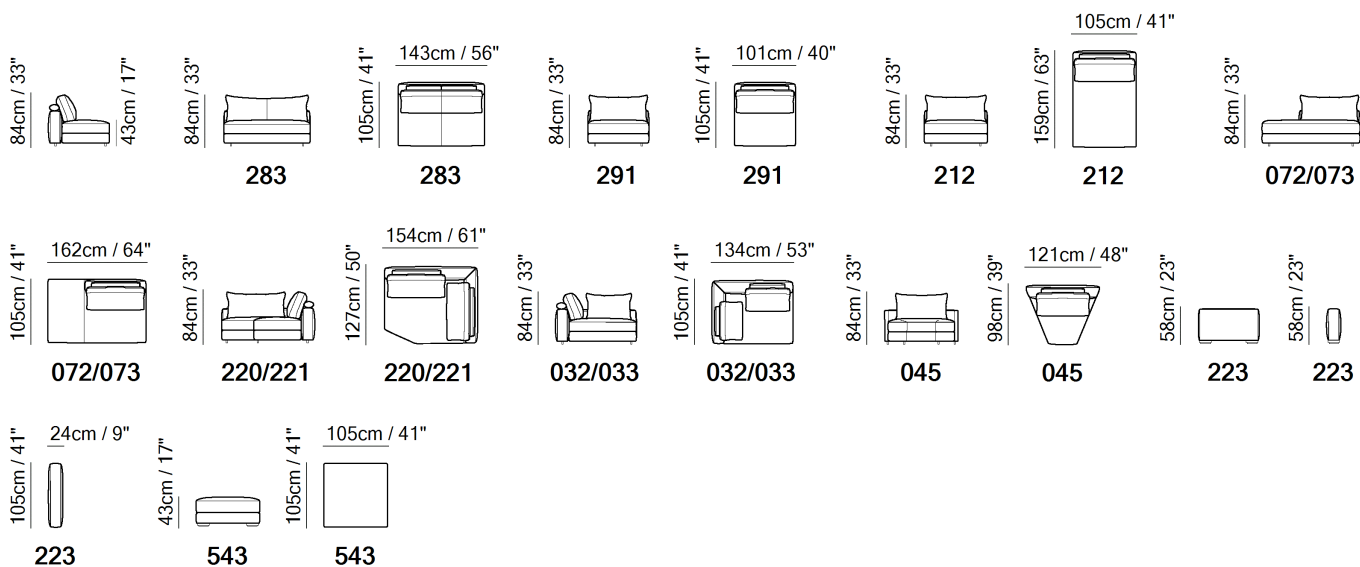

## COMPOSITION EXAMPLES

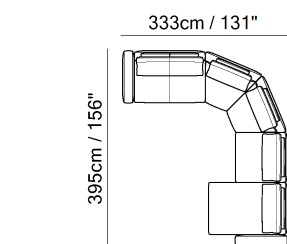

223+283+045+045+291+212+223

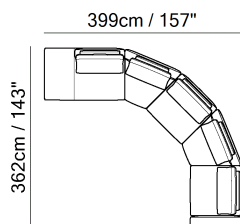

072+045+291+045+291+223

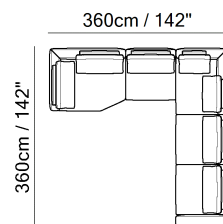

221+291+032+291+291+223

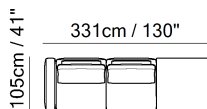



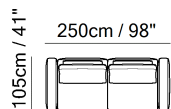



223+291+291+543



223+291+291+223

TECHNICAL INFORMATION

	<b>COVERING</b>	Leather <input checked="" type="checkbox"/>	Soft Cover <input checked="" type="checkbox"/>				
	<b>FILLING</b>	Arms	<input type="checkbox"/> Fiber <input checked="" type="checkbox"/> Foam <input type="checkbox"/> Feather/Fiber Mix <input type="checkbox"/> Feather	Seat cushion	<input type="checkbox"/> Fiber <input checked="" type="checkbox"/> Foam <input type="checkbox"/> Feather/Fiber Mix <input checked="" type="checkbox"/> Feather	Back cushion	<input type="checkbox"/> Fiber <input type="checkbox"/> Foam <input type="checkbox"/> Feather/Fiber Mix <input checked="" type="checkbox"/> Feather
	<b>COMFORT</b>	Standard Comfort <input checked="" type="checkbox"/>	Firm Comfort <input type="checkbox"/>				
	<b>FUNCTION</b>	Bed <input type="checkbox"/>	Electric motion <input type="checkbox"/>	Motion <input type="checkbox"/>	Recliner <input type="checkbox"/>	Sliding <input type="checkbox"/>	
	<b>VISUAL APPEARANCE*</b>	Low <input type="checkbox"/>	Medium <input type="checkbox"/>	High <input checked="" type="checkbox"/>			
	<b>LEGS</b>	Wood <input type="checkbox"/>	Plastic <input type="checkbox"/>	Metal <input type="checkbox"/>	Upholstered <input type="checkbox"/>	Castors <input type="checkbox"/>	

VISUAL APPEARANCE

The product may reveal various wrinkles due to the combination of Elasticity of the covering, characteristics of the interior construction and the design of the product.



Products with Visual Appearance listed as High or Medium would require higher degree of care, where seats and back cushions may require fluffing and plumping more often than Products with Visual Appearance listed as Low.

NOTES

- Designed by Natuzzi Design Center.
- Date of launch: 2024.

NOTES

---



■ Vers. 450+452



■ Vers. 450+338+452



■ Vers. 450+821+338+452



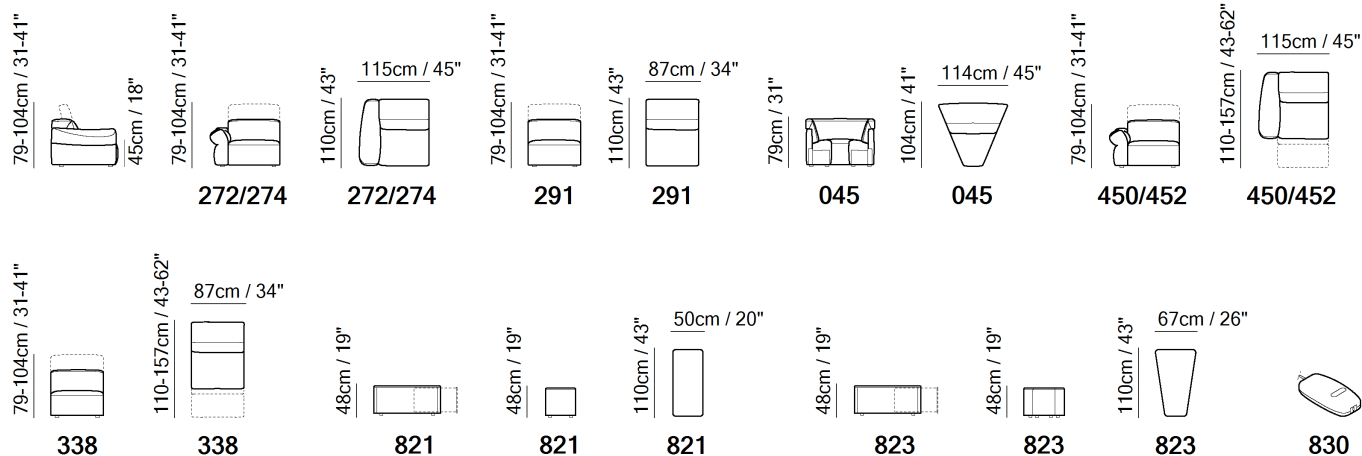

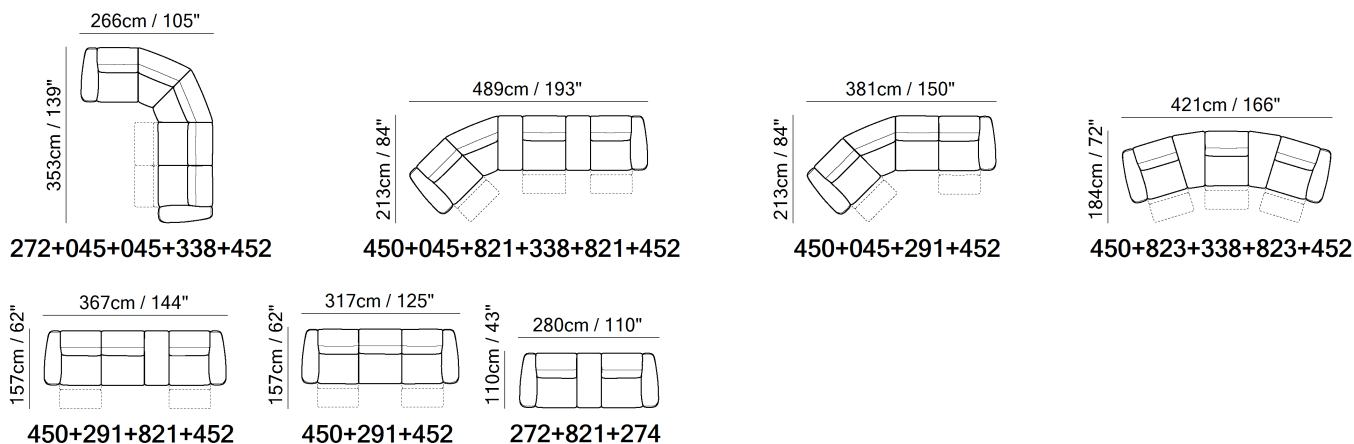

## SCHEMATICS



## COMPOSITION EXAMPLES



TECHNICAL INFORMATION

	<b>COVERING</b>	Leather <input checked="" type="checkbox"/>					
	<b>FILLING</b>	Arms	<input type="checkbox"/> Fiber	Seat cushion	<input type="checkbox"/> Fiber	Back cushion	<input type="checkbox"/> Fiber
			<input checked="" type="checkbox"/> Foam		<input checked="" type="checkbox"/> Foam		<input checked="" type="checkbox"/> Foam
			<input type="checkbox"/> Feather/Fiber Mix		<input type="checkbox"/> Feather/Fiber Mix		<input type="checkbox"/> Feather/Fiber Mix
			<input type="checkbox"/> Feather		<input type="checkbox"/> Feather		<input type="checkbox"/> Feather
	<b>COMFORT</b>	Standard Comfort	Firm Comfort				
		<input checked="" type="checkbox"/>	<input type="checkbox"/>				
	<b>FUNCTION</b>	Bed	Electric motion	Motion	Recliner	Sliding	
		<input type="checkbox"/>	<input checked="" type="checkbox"/>	<input type="checkbox"/>	<input type="checkbox"/>	<input type="checkbox"/>	
	<b>VISUAL APPEARANCE*</b>	Low	Medium	High			
		<input type="checkbox"/>	<input checked="" type="checkbox"/>	<input type="checkbox"/>			
	<b>LEGS</b>	Wood	Metal	Plastic	Castors	Upholstered	
		<input type="checkbox"/>	<input type="checkbox"/>	<input type="checkbox"/>	<input type="checkbox"/>	<input type="checkbox"/>	

VISUAL APPEARANCE

The product may reveal various wrinkles due to the combination of Elasticity of the covering, characteristics of the interior construction and the design of the product.



Products with Visual Appearance listed as High or Medium would require higher degree of care, where seats and back cushions may require fluffing and plumping more often than Products with Visual Appearance listed as Low.

NOTES

- Designed by Natuzzi Design Center.
- Date of launch: 2024.
- Available in leather or fabric.
- Introducing the new Faraone sofa, it has been inspired by Queen Nefertiti. Queen Nefertiti was an ancient Egyptian queen renowned for her beauty and power. This modular sofa features the profile of Nefertiti's bust on the armrest.
- In leather, to avoid cuts on the seat and back cushions, the model is available starting from cat. 15; only in article LE MANS
- Model also available with thick leather with model code Sxxx (Art. Cassidy cat.60, Misterbianco cat.30).
- Use code V309 to order Faraone in all fabric categories currently in our Natuzzi Italia soft covering collection.
- Faraone leather version sofa is distinguished by its moccasin-style stitching, which elegantly runs along the headrest, arms, and front seat profile. This detailed stitching not only enhances the aesthetic appeal but also underscores the Natuzzi craftsmanship and the attention to detail that goes into each piece.
- It offers both motion recliner and non-recliner modules.

## NOTES

---

- The mechanism of the sofa with a dual motor recliner is very intuitive. With the two buttons on the front part of the control panel, the headrest opens first simultaneously, and once opened, the footrest opens.
- The two buttons on the inner part of the control panel, towards the backrest, allow you to individually control the position of the headrest, tilting it further and bringing it to a more advanced position. This provides better comfort when watching TV, reading a book, or relaxing.
- By distributing weight evenly across all pressure points, the zero-gravity power motion system makes you feel weightless. It takes the pressure off your spine and can promote circulation in the legs.  
The definition of Zero Gravity Reclining is the ability for your heart to be resting above your feet which provides proven health benefits.
- The Faraone sofa is also available with a 45-degree corner option and includes in between seat consoles, rectangular or trapezoidal, complete with storage compartments. The finish of the table tops is in Matt Chocolate finish.



■ Vers. 272+274



■ Vers. 272+274



■ Vers. 272+274



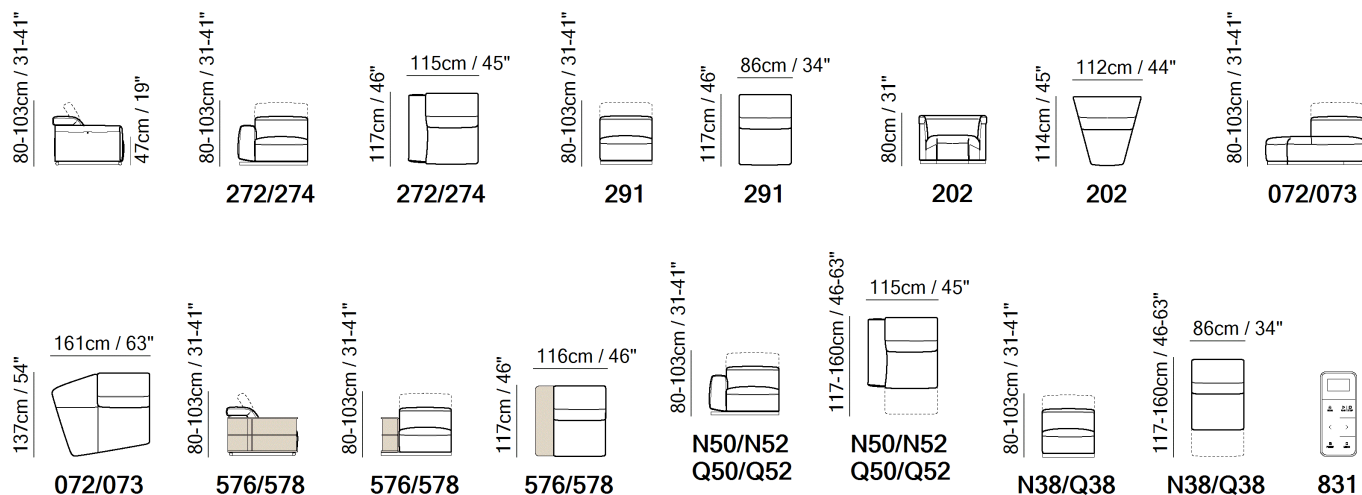

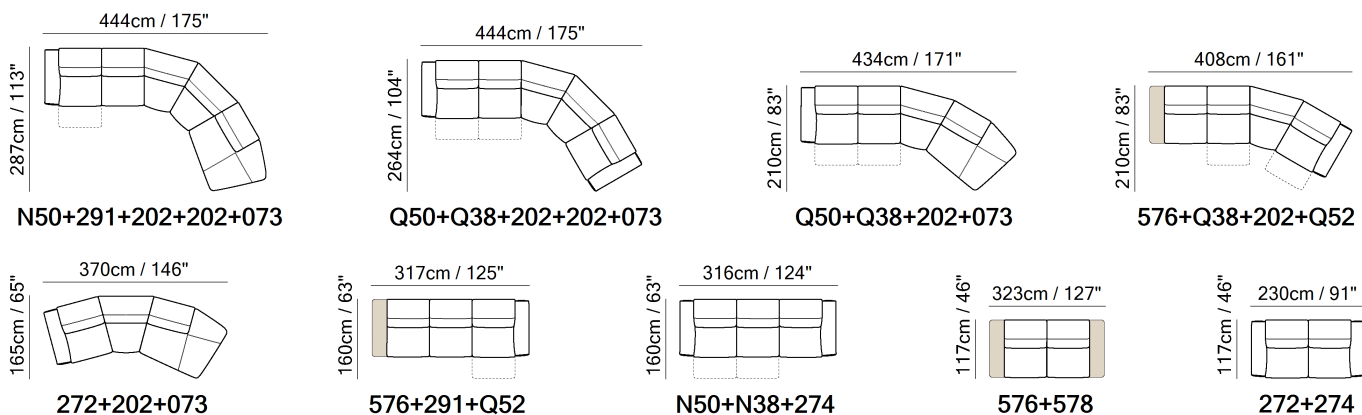

SCHEMATICS



COMPOSITION EXAMPLES



TECHNICAL INFORMATION

	<b>COVERING</b>	Leather <input checked="" type="checkbox"/>	Soft Cover <input checked="" type="checkbox"/>				
	<b>FILLING</b>	Arms	<input type="checkbox"/> Fiber <input checked="" type="checkbox"/> Foam <input type="checkbox"/> Feather/Fiber Mix <input type="checkbox"/> Feather	Seat cushion	<input type="checkbox"/> Fiber <input checked="" type="checkbox"/> Foam <input type="checkbox"/> Feather/Fiber Mix <input type="checkbox"/> Feather	Back cushion	<input type="checkbox"/> Fiber <input checked="" type="checkbox"/> Foam <input type="checkbox"/> Feather/Fiber Mix <input type="checkbox"/> Feather
	<b>COMFORT</b>	Standard Comfort <input checked="" type="checkbox"/>	Firm Comfort <input type="checkbox"/>				
	<b>FUNCTION</b>	Bed <input type="checkbox"/>	Electric motion <input type="checkbox"/>	Motion <input checked="" type="checkbox"/>	Recliner <input type="checkbox"/>	Sliding <input type="checkbox"/>	
	<b>VISUAL APPEARANCE*</b>	Low <input checked="" type="checkbox"/>	Medium <input type="checkbox"/>	High <input type="checkbox"/>			
	<b>LEGS</b>	Wood <input type="checkbox"/>	Plastic <input type="checkbox"/>	Metal <input type="checkbox"/>	Upholstered <input type="checkbox"/>	Castors <input type="checkbox"/>	

VISUAL APPEARANCE

The product may reveal various wrinkles due to the combination of Elasticity of the covering, characteristics of the interior construction and the design of the product.



Products with Visual Appearance listed as High or Medium would require higher degree of care, where seats and back cushions may require fluffing and plumping more often than Products with Visual Appearance listed as Low.

NOTES

NOTES

---



■ Vers.









■ Vers.



■ Vers.



TECHNICAL INFORMATION

	<b>COVERING</b>	Leather <input checked="" type="checkbox"/>	Soft Cover <input checked="" type="checkbox"/>			
	<b>FILLING</b>	Arms <input type="checkbox"/> Fiber <input checked="" type="checkbox"/> Foam <input type="checkbox"/> Feather/Fiber Mix <input type="checkbox"/> Feather	Seat cushion <input type="checkbox"/> Fiber <input checked="" type="checkbox"/> Foam <input type="checkbox"/> Feather/Fiber Mix <input type="checkbox"/> Feather	Back cushion <input type="checkbox"/> Fiber <input checked="" type="checkbox"/> Foam <input type="checkbox"/> Feather/Fiber Mix <input type="checkbox"/> Feather		
	<b>COMFORT</b>	Standard Comfort <input checked="" type="checkbox"/>	Firm Comfort <input type="checkbox"/>			
	<b>FUNCTION</b>	Bed <input type="checkbox"/>	Electric motion <input type="checkbox"/>	Motion <input type="checkbox"/>	Recliner <input type="checkbox"/>	Sliding <input type="checkbox"/>
	<b>VISUAL APPEARANCE*</b>	Low <input type="checkbox"/>	Medium <input type="checkbox"/>	High <input checked="" type="checkbox"/>		
	<b>LEGS</b>	Wood <input type="checkbox"/>	Metal <input type="checkbox"/>	Plastic <input type="checkbox"/>	Castors <input type="checkbox"/>	Upholstered <input type="checkbox"/>

VISUAL APPEARANCE

The product may reveal various wrinkles due to the combination of Elasticity of the covering, characteristics of the interior construction and the design of the product.



Products with Visual Appearance listed as High or Medium would require higher degree of care, where seats and back cushions may require fluffing and plumping more often than Products with Visual Appearance listed as Low.

NOTES

NOTES

---



■ Vers. 003

## SCHEMATICS

---

91cm / 36"



47cm / 19"

91cm / 36"



003

82cm / 32"



003

103cm / 41"

82cm / 32"







066

103cm / 41"

## TECHNICAL INFORMATION

---

	<b>COVERING</b>	Leather <input checked="" type="checkbox"/>	Soft Cover <input checked="" type="checkbox"/>				
	<b>FILLING</b>	Arms	<input type="checkbox"/> Fiber <input type="checkbox"/> Foam <input type="checkbox"/> Feather/Fiber Mix <input type="checkbox"/> Feather	Seat cushion	<input type="checkbox"/> Fiber <input type="checkbox"/> Foam <input type="checkbox"/> Feather/Fiber Mix <input type="checkbox"/> Feather	Back cushion	<input type="checkbox"/> Fiber <input type="checkbox"/> Foam <input type="checkbox"/> Feather/Fiber Mix <input type="checkbox"/> Feather
	<b>COMFORT</b>	Standard Comfort <input checked="" type="checkbox"/>	Firm Comfort <input type="checkbox"/>				
	<b>FUNCTION</b>	Bed <input type="checkbox"/>	Electric motion <input type="checkbox"/>	Motion <input type="checkbox"/>	Recliner <input type="checkbox"/>	Sliding <input type="checkbox"/>	
	<b>LEGS</b>	Wood <input type="checkbox"/>	Plastic <input type="checkbox"/>	Metal <input type="checkbox"/>	Upholstered <input type="checkbox"/>	Castors <input type="checkbox"/>	

## NOTES

---

NOTES

---



■ Vers. 006



■ Vers. 006







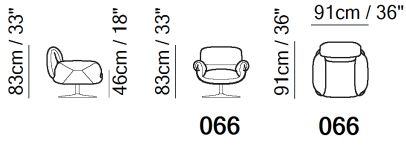

■ Vers. 006

SCHEMATICS

---



TECHNICAL INFORMATION

	<b>COVERING</b>	Leather <input checked="" type="checkbox"/>	Soft Cover <input checked="" type="checkbox"/>				
	<b>FILLING</b>	Arms	<input type="checkbox"/> Fiber <input type="checkbox"/> Foam <input type="checkbox"/> Feather/Fiber Mix <input type="checkbox"/> Feather	Seat cushion	<input type="checkbox"/> Fiber <input type="checkbox"/> Foam <input type="checkbox"/> Feather/Fiber Mix <input type="checkbox"/> Feather	Back cushion	<input type="checkbox"/> Fiber <input type="checkbox"/> Foam <input type="checkbox"/> Feather/Fiber Mix <input type="checkbox"/> Feather
	<b>COMFORT</b>	Standard Comfort <input checked="" type="checkbox"/>	Firm Comfort <input type="checkbox"/>				
	<b>FUNCTION</b>	Bed <input type="checkbox"/>	Electric motion <input type="checkbox"/>	Motion <input type="checkbox"/>	Recliner <input type="checkbox"/>	Sliding <input type="checkbox"/>	
	<b>VISUAL APPEARANCE*</b>	Low <input checked="" type="checkbox"/>	Medium <input type="checkbox"/>	High <input type="checkbox"/>			
	<b>LEGS</b>	Wood <input type="checkbox"/>	Metal <input type="checkbox"/>	Plastic <input type="checkbox"/>	Castors <input type="checkbox"/>	Upholstered <input type="checkbox"/>	

VISUAL APPEARANCE

The product may reveal various wrinkles due to the combination of Elasticity of the covering, characteristics of the interior construction and the design of the product.



Products with Visual Appearance listed as High or Medium would require higher degree of care, where seats and back cushions may require fluffing and plumping more often than Products with Visual Appearance listed as Low.

NOTES

NOTES

---



■ Vers. 088



■ Vers. 088



■ Vers. 003



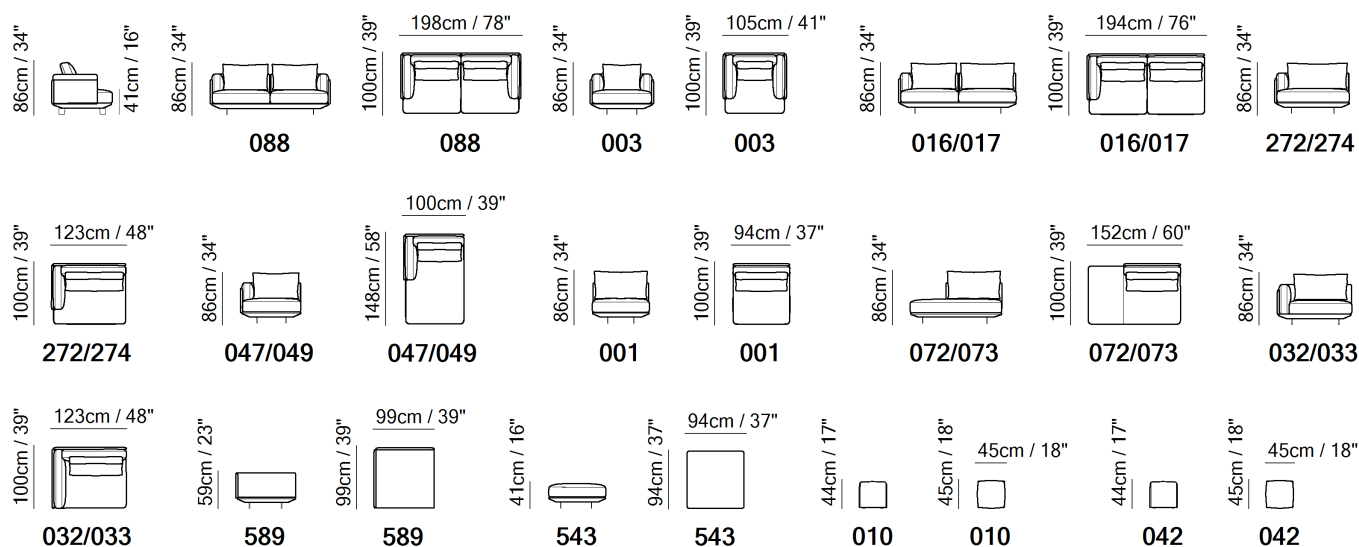

## SCHEMATICS

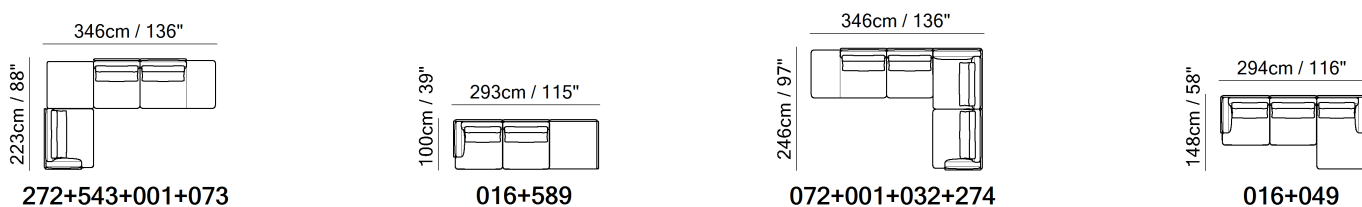

## COMPOSITION EXAMPLES



TECHNICAL INFORMATION

	<b>COVERING</b>	Leather <input checked="" type="checkbox"/>	Soft Cover <input checked="" type="checkbox"/>				
	<b>FILLING</b>	Arms	<input type="checkbox"/> Fiber <input checked="" type="checkbox"/> Foam <input type="checkbox"/> Feather/Fiber Mix <input type="checkbox"/> Feather	Seat cushion	<input type="checkbox"/> Fiber <input checked="" type="checkbox"/> Foam <input type="checkbox"/> Feather/Fiber Mix <input type="checkbox"/> Feather	Back cushion	<input type="checkbox"/> Fiber <input checked="" type="checkbox"/> Foam <input type="checkbox"/> Feather/Fiber Mix <input type="checkbox"/> Feather
	<b>COMFORT</b>	Standard Comfort <input checked="" type="checkbox"/>	Firm Comfort <input type="checkbox"/>				
	<b>FUNCTION</b>	Bed <input type="checkbox"/>	Electric motion <input type="checkbox"/>	Motion <input type="checkbox"/>	Recliner <input type="checkbox"/>	Sliding <input type="checkbox"/>	
	<b>LEGS</b>	Wood <input type="checkbox"/>	Plastic <input type="checkbox"/>	Metal <input checked="" type="checkbox"/>	Upholstered <input type="checkbox"/>	Castors <input type="checkbox"/>	

NOTES

- Designed by Mauro Lipparini.
- Date of launch: 2019.
- The intricate but yet measured, and sophisticated design makes this model a witness of timeless forms and languages, with a modern tract.
- With the code 3147, it is possible to order CAMPUS outer frame in basket woven suede Gargano, with irregular weaves. The final consumer can choose between 7 colors of suede to match freely with the leather and fabric articles of the Natuzzi Italia collection.
- Model is not available with article Misterbianco (cat. 30).
- Seat cushion includes a layer of memory foam, a pressure-sensitive soft polyurethane, that recovers its form completely thus giving great comfort.
- Comfort >> The mix of padding in polyurethane and Climalight (special latest-generation silicone microfibre) guarantees a look and support that does not change over time.
- The version 589 can be used both as a corner and as a terminal module in a linear configuration and it is in tobacco-colored ash wood or eucalyptus wood.
- Anti-slip lining under the seat cushions to prevent them from sliding down when seated.
- In leather version module side panels are fully upholstered.
- Seat and back cushions aren't fixed to the frame.
- Metal feet available in two finishes: 46 glossy champagne and 79 matt black with anti-scratch foot liners.
- The colour of the zip is always linked with the colour of the feet chosen. When the feet finish is champagne (46), the color of the zip is gold. When the feet finish is matt black (79), the color of the zip is silver.
- Feet will be in a bag inside the package and requires assembling.

## NOTES

---

- Feet height 11,0 cm



■ Vers. 003



■ Vers. 003





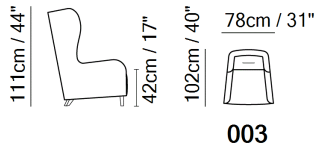

■ Vers. 003

SCHEMATICS

---



TECHNICAL INFORMATION

	<b>COVERING</b>	Soft Cover <input checked="" type="checkbox"/>				
	<b>FILLING</b>	<b>Arms</b> <input type="checkbox"/> Fiber <input checked="" type="checkbox"/> Foam <input type="checkbox"/> Feather/Fiber Mix <input type="checkbox"/> Feather	<b>Seat cushion</b> <input type="checkbox"/> Fiber <input checked="" type="checkbox"/> Foam <input type="checkbox"/> Feather/Fiber Mix <input type="checkbox"/> Feather	<b>Back cushion</b> <input type="checkbox"/> Fiber <input checked="" type="checkbox"/> Foam <input type="checkbox"/> Feather/Fiber Mix <input type="checkbox"/> Feather		
	<b>COMFORT</b>	Standard Comfort <input checked="" type="checkbox"/>	Firm Comfort <input type="checkbox"/>			
	<b>FUNCTION</b>	Bed <input type="checkbox"/>	Electric motion <input type="checkbox"/>	Motion <input type="checkbox"/>	Recliner <input type="checkbox"/>	Sliding <input type="checkbox"/>
	<b>LEGS</b>	Wood <input checked="" type="checkbox"/>	Metal <input type="checkbox"/>	Plastic <input type="checkbox"/>	Castors <input type="checkbox"/>	Upholstered <input type="checkbox"/>

NOTES

- Tight Seat Cushion (the seat cushions of the models are fixed to the frame)
- Tight Back Cushion (the back cushions of the models are fixed to the frame)
- Internal wooden frame.
- Feet will be in a bag inside the package and requires assembling.
- Packaging: Cardboard wrap.
- Front feet are slightly higher in respect to rear.
- Feet available in wood finishings 09 (Walnut) / 18 (Wengè)
- Feet height 13,0/8,0 cm

**NOTES**

---



■ Vers. 272+274



■ Vers. 100+291+291



■ Vers. 272+291+032+291+049



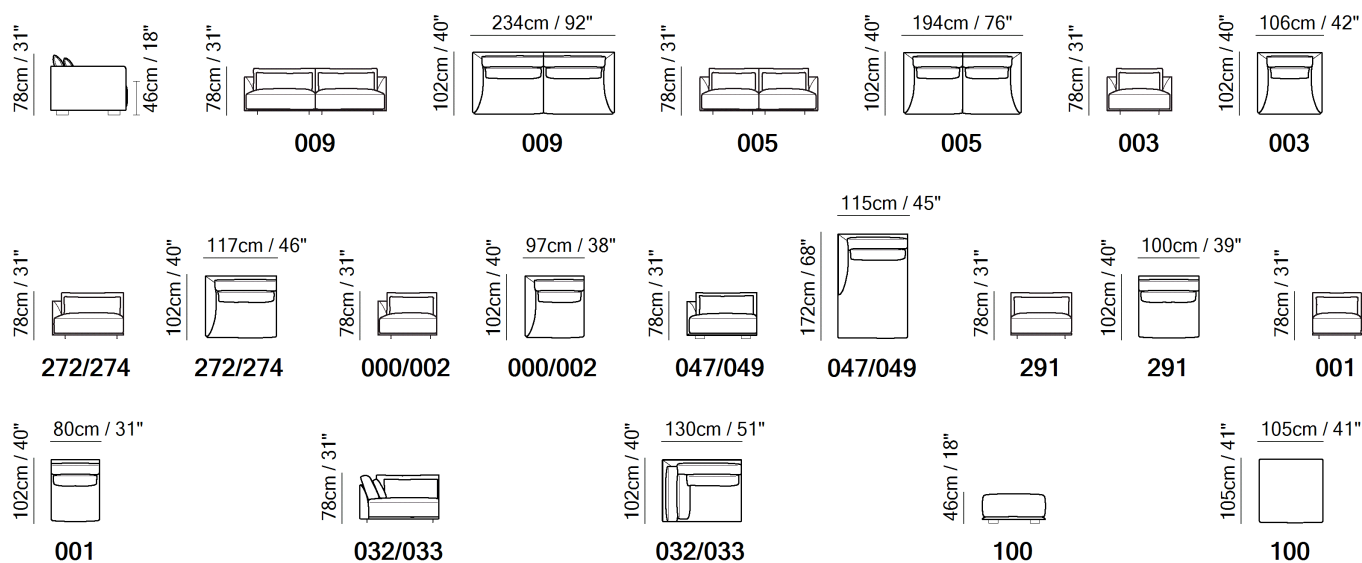

SCHEMATICS

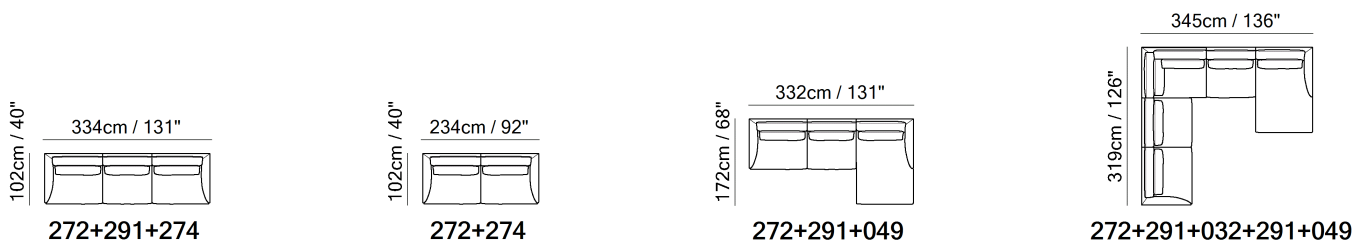

COMPOSITION EXAMPLES



**TECHNICAL INFORMATION**

	<b>COVERING</b>	Soft Cover <input checked="" type="checkbox"/>				
	<b>FILLING</b>	<b>Arms</b> <input type="checkbox"/> Fiber <input checked="" type="checkbox"/> Foam <input type="checkbox"/> Feather/Fiber Mix <input type="checkbox"/> Feather	<b>Seat cushion</b> <input type="checkbox"/> Fiber <input checked="" type="checkbox"/> Foam <input type="checkbox"/> Feather/Fiber Mix <input checked="" type="checkbox"/> Feather	<b>Back cushion</b> <input type="checkbox"/> Fiber <input type="checkbox"/> Foam <input type="checkbox"/> Feather/Fiber Mix <input checked="" type="checkbox"/> Feather		
	<b>COMFORT</b>	Standard Comfort <input checked="" type="checkbox"/>	Firm Comfort <input type="checkbox"/>			
	<b>FUNCTION</b>	Bed <input type="checkbox"/>	Electric motion <input type="checkbox"/>	Motion <input type="checkbox"/>	Recliner <input type="checkbox"/>	Sliding <input type="checkbox"/>
	<b>LEGS</b>	Wood <input type="checkbox"/>	Plastic <input type="checkbox"/>	Metal <input checked="" type="checkbox"/>	Upholstered <input type="checkbox"/>	Castors <input type="checkbox"/>

**NOTES**

- Long Beach sofa, designed by renowned Italian architect, Claudio Bellini.
- This soft, welcoming design features height-adjustable feet, to suit your personal style.
- The thin armrests leave plenty of room for enjoying the wide, comfortable seats.
- Seat cushion includes a layer of memory foam, a pressure-sensitive soft polyurethane, that recovers its form completely thus giving great comfort.
- Loose Seat Cushion (the seat cushions of the model are not fixed to the frame)
- Loose Back Cushion (the back cushions of the model are not fixed to the frame)
- Internal wooden frame.
- With Feet Assembled (the model will be loaded with feet already mounted on the sofa).
- Feet available in metal
- Feet height 6,0 / 9,0 cm
- It is possible to change feet height (see user's instructions)

NOTES

---



■ Vers. 009



■ Vers. 009



■ Vers. 247+019



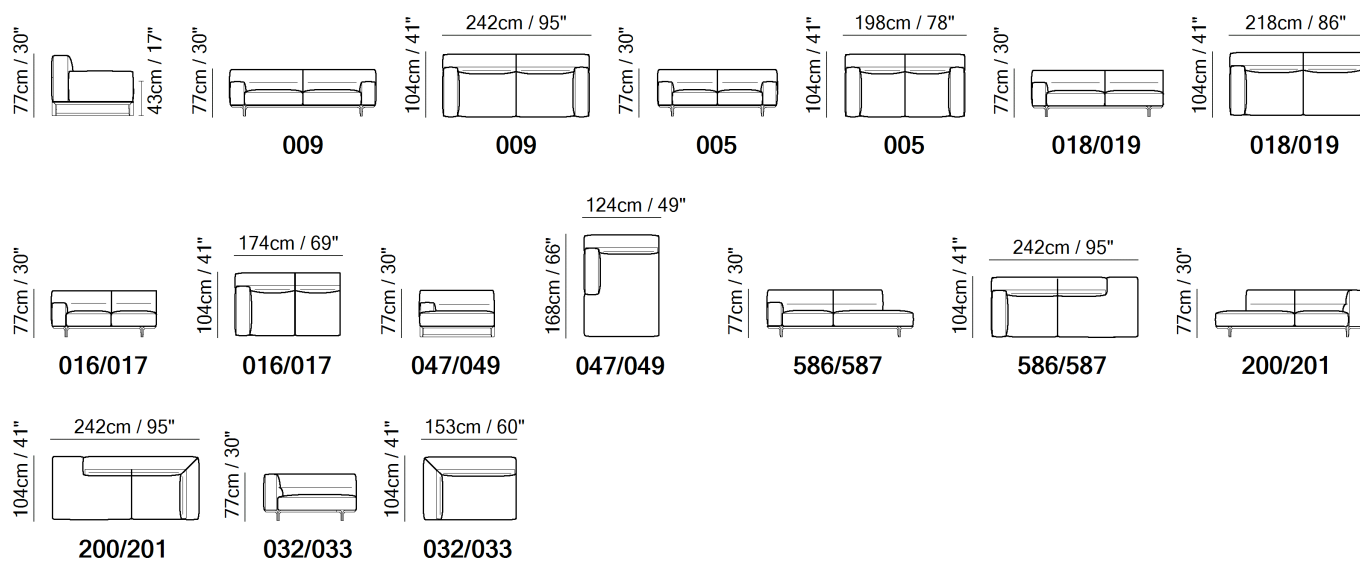

## SCHEMATICS

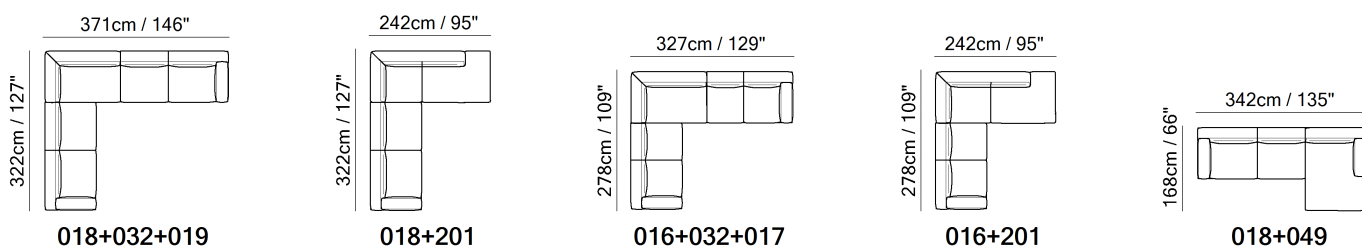

## COMPOSITION EXAMPLES



TECHNICAL INFORMATION

	<b>COVERING</b>	Leather <input checked="" type="checkbox"/>					
	<b>FILLING</b>	Arms	<input type="checkbox"/> Fiber	Seat cushion	<input type="checkbox"/> Fiber	Back cushion	<input type="checkbox"/> Fiber
			<input checked="" type="checkbox"/> Foam		<input checked="" type="checkbox"/> Foam		<input checked="" type="checkbox"/> Foam
			<input type="checkbox"/> Feather/Fiber Mix		<input type="checkbox"/> Feather/Fiber Mix		<input type="checkbox"/> Feather/Fiber Mix
			<input type="checkbox"/> Feather		<input type="checkbox"/> Feather		<input type="checkbox"/> Feather
	<b>COMFORT</b>	Standard Comfort <input checked="" type="checkbox"/>	Firm Comfort <input type="checkbox"/>				
	<b>FUNCTION</b>	Bed <input type="checkbox"/>	Electric motion <input type="checkbox"/>	Motion <input type="checkbox"/>	Recliner <input type="checkbox"/>	Sliding <input type="checkbox"/>	
	<b>LEGS</b>	Wood <input checked="" type="checkbox"/>	Metal <input type="checkbox"/>	Plastic <input type="checkbox"/>	Castors <input type="checkbox"/>	Upholstered <input type="checkbox"/>	

NOTES

- Designed by Tapinassi & Manzoni.
- Date of launch: 2017.
- A perfect combination of modularity, craftsmanship and refined design. Kendo brings its refined personality to every living area, enhanced by precious details and exceptional comfort.
- Model available in Misterbianco and Cassidy leathers.
- Model is characterized by a special «raw cut stitching» (cut pinched stitching).
- Comfort >> The mix of padding in polyurethane and Climalight (special latest-generation silicone microfibre) guarantees a look and support that does not change over time.
- Seat cushion includes a layer of memory foam, a pressure-sensitive soft polyurethane, that recovers its form completely thus giving great comfort.
- Seat and back cushions are fixed to the frame.
- In leather version module side panels are fully upholstered.
- Internal wooden frame.
- Feet available in wooden finishings 32 (Smoked Oak) with metal insert in brass / 33 (Olive Walnut; with upcharge) with metal insert in color pewter
- Feet requires assembling. Feet will be in a separate package.
- Feet height 14,0 cm

**NOTES**

---





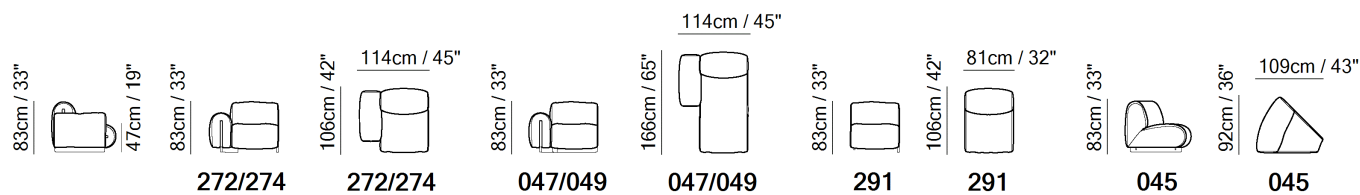

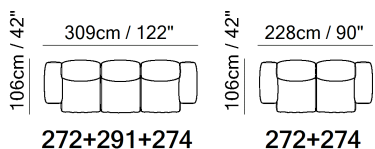
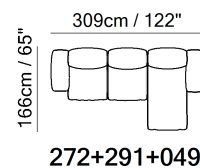
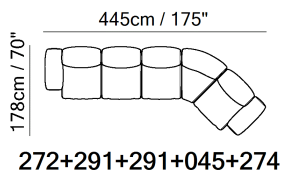
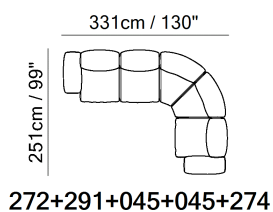
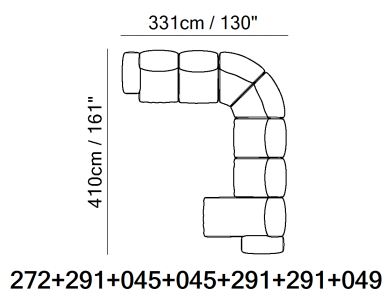

## SCHEMATICS



## COMPOSITION EXAMPLES



TECHNICAL INFORMATION

	<b>COVERING</b>	Leather <input checked="" type="checkbox"/>					
	<b>FILLING</b>	Arms	<input type="checkbox"/> Fiber <input type="checkbox"/> Foam <input type="checkbox"/> Feather/Fiber Mix <input type="checkbox"/> Feather	Seat cushion	<input type="checkbox"/> Fiber <input type="checkbox"/> Foam <input type="checkbox"/> Feather/Fiber Mix <input type="checkbox"/> Feather	Back cushion	<input type="checkbox"/> Fiber <input type="checkbox"/> Foam <input type="checkbox"/> Feather/Fiber Mix <input type="checkbox"/> Feather
	<b>COMFORT</b>	Standard Comfort <input checked="" type="checkbox"/>	Firm Comfort <input type="checkbox"/>				
	<b>FUNCTION</b>	Bed <input type="checkbox"/>	Electric motion <input type="checkbox"/>	Motion <input type="checkbox"/>	Recliner <input type="checkbox"/>	Sliding <input type="checkbox"/>	
	<b>VISUAL APPEARANCE*</b>	Low <input type="checkbox"/>	Medium <input type="checkbox"/>	High <input checked="" type="checkbox"/>			
	<b>LEGS</b>	Wood <input type="checkbox"/>	Plastic <input type="checkbox"/>	Metal <input type="checkbox"/>	Upholstered <input type="checkbox"/>	Castors <input type="checkbox"/>	

VISUAL APPEARANCE

The product may reveal various wrinkles due to the combination of Elasticity of the covering, characteristics of the interior construction and the design of the product.



Products with Visual Appearance listed as High or Medium would require higher degree of care, where seats and back cushions may require fluffing and plumping more often than Products with Visual Appearance listed as Low.

NOTES

- Designed by STUDIO BIG – Bjarke Ingels Group.
- Date of launch: 2024.
- Colle draws inspiration from the first Natuzzi models recognised worldwide for their soft and hospitable style. It's a key feature of this model that harmoniously portrays the relaxation typical of the Mediterranean life.  
The design is distinguished by the pleasant "wrinkles" that are created on the covering, which enhance the softness of the design and the sense of visual comfort.
- Model available in Misterbianco and Cassidy leathers.
- Model is characterized by a special «raw cut stitching» (cut pinched stitching).
- Tone-on-tone edging along the profile of each individual module that emphasizes its roundness and enhances its design.
- Seat cushion includes a layer of memory foam, a pressure-sensitive soft polyurethane, that recovers its form completely thus giving great comfort.
- Internal plywood frame, elastic straps under the seat cushions and on the backrest.
- Removable hooks on each seating module.
- Smoked ash exposed structure (ST12).

## NOTES

---

- The wooden base with anti-scratch and non-slip rubbers offer a practical solution for protecting floors.  
Wooden base requires assembling and it is located in an envelope inside the package  
Base height 8 cm.



■ Vers. 272+274







■ Vers. 272+291+274



■ Vers. 272+274



TECHNICAL INFORMATION

	<b>COVERING</b>	Leather <input checked="" type="checkbox"/>					
	<b>FILLING</b>	Arms	<input type="checkbox"/> Fiber	Seat cushion	<input type="checkbox"/> Fiber	Back cushion	<input type="checkbox"/> Fiber
			<input checked="" type="checkbox"/> Foam		<input checked="" type="checkbox"/> Foam		<input checked="" type="checkbox"/> Foam
			<input type="checkbox"/> Feather/Fiber Mix		<input type="checkbox"/> Feather/Fiber Mix		<input type="checkbox"/> Feather/Fiber Mix
			<input type="checkbox"/> Feather		<input type="checkbox"/> Feather		<input type="checkbox"/> Feather
	<b>COMFORT</b>	Standard Comfort	Firm Comfort				
		<input checked="" type="checkbox"/>	<input type="checkbox"/>				
	<b>FUNCTION</b>	Bed	Electric motion	Motion	Recliner	Sliding	
		<input type="checkbox"/>	<input type="checkbox"/>	<input type="checkbox"/>	<input type="checkbox"/>	<input type="checkbox"/>	
	<b>VISUAL APPEARANCE*</b>	Low	Medium	High			
		<input checked="" type="checkbox"/>	<input type="checkbox"/>	<input type="checkbox"/>			
	<b>LEGS</b>	Wood	Metal	Plastic	Castors	Upholstered	
		<input type="checkbox"/>	<input type="checkbox"/>	<input type="checkbox"/>	<input type="checkbox"/>	<input type="checkbox"/>	

VISUAL APPEARANCE

The product may reveal various wrinkles due to the combination of Elasticity of the covering, characteristics of the interior construction and the design of the product.



Products with Visual Appearance listed as High or Medium would require higher degree of care, where seats and back cushions may require fluffing and plumping more often than Products with Visual Appearance listed as Low.

NOTES

- Designed by Karim Rashid.
- Date of launch: 2024.
- Memoria made of soft curves and sinuous lines, wants to emphasize the beauty of the encounter and the sweet fluidity of human relationships.
- In leather the model is available starting from cat. 25 (Status).
- Seat and back cushions in high density polyurethane foam.
- Modular sofa available in linear and sectional versions with a soft and wavy corner (vers.029). Memoria is available with a sophisticated terminal version (vers. 220/221) and an organically sinuous three-seater with one arm version that provides 2 different seat depths (vers 216/217).
- Upholstered side
- Removable hooks on each seating module.
- 4cm hidden metal feet with anti-scratch and non-slip rubbers.

**NOTES**

---



■ Vers. 450+452



■ Vers. 450+338+452



■ Vers. 450+821+338+452



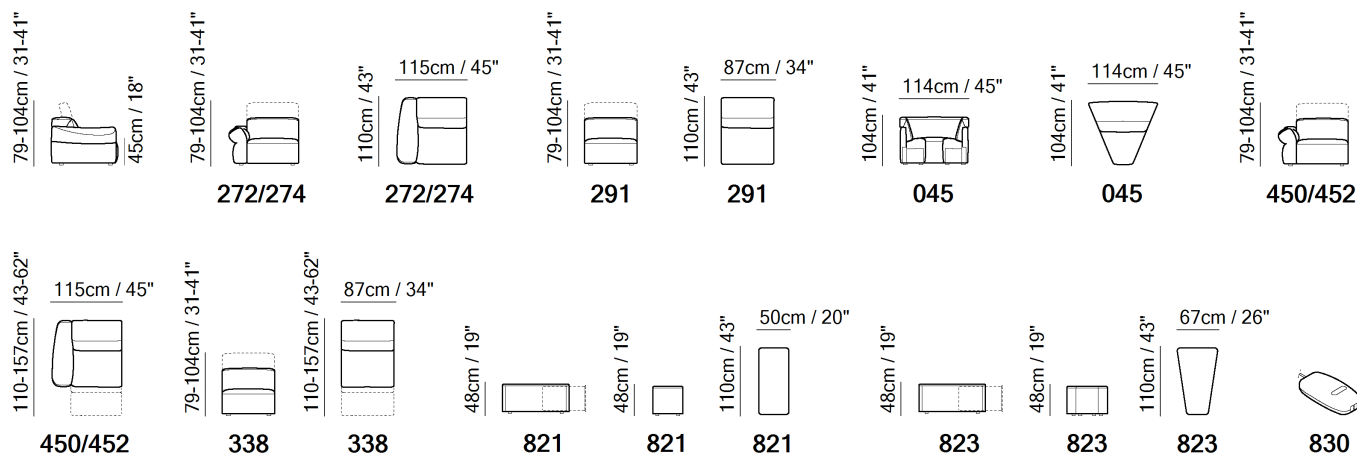

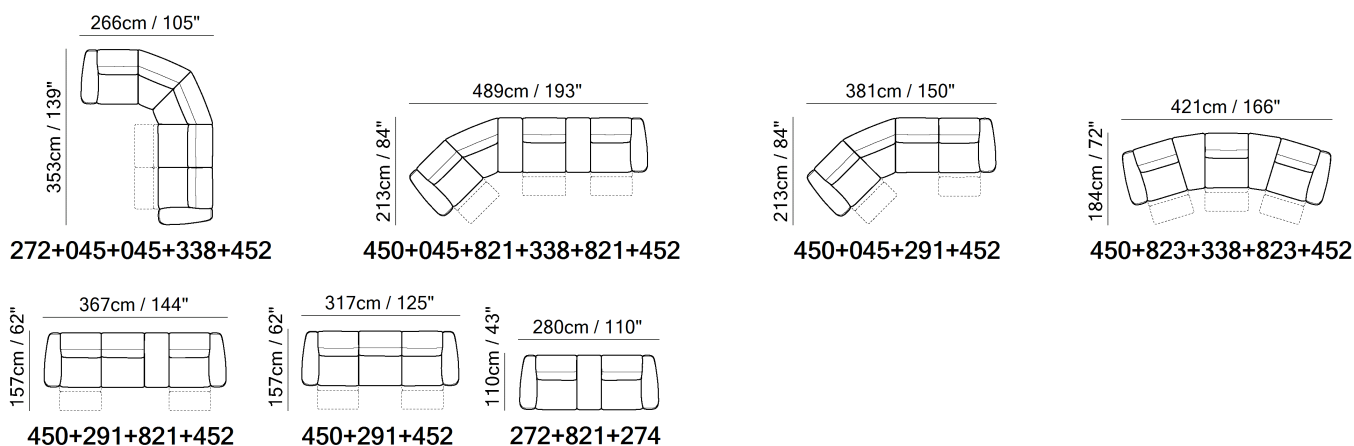

## SCHEMATICS



## COMPOSITION EXAMPLES



TECHNICAL INFORMATION

	<b>COVERING</b>	Leather <input checked="" type="checkbox"/>					
	<b>FILLING</b>	Arms	<input type="checkbox"/> Fiber <input checked="" type="checkbox"/> Foam <input type="checkbox"/> Feather/Fiber Mix <input type="checkbox"/> Feather	Seat cushion	<input type="checkbox"/> Fiber <input checked="" type="checkbox"/> Foam <input type="checkbox"/> Feather/Fiber Mix <input type="checkbox"/> Feather	Back cushion	<input type="checkbox"/> Fiber <input checked="" type="checkbox"/> Foam <input type="checkbox"/> Feather/Fiber Mix <input type="checkbox"/> Feather
	<b>COMFORT</b>	Standard Comfort <input checked="" type="checkbox"/>	Firm Comfort <input type="checkbox"/>				
	<b>FUNCTION</b>	Bed <input type="checkbox"/>	Electric motion <input checked="" type="checkbox"/>	Motion <input type="checkbox"/>	Recliner <input type="checkbox"/>	Sliding <input type="checkbox"/>	
	<b>VISUAL APPEARANCE*</b>	Low <input type="checkbox"/>	Medium <input checked="" type="checkbox"/>	High <input type="checkbox"/>			
	<b>LEGS</b>	Wood <input type="checkbox"/>	Plastic <input type="checkbox"/>	Metal <input type="checkbox"/>	Upholstered <input type="checkbox"/>	Castors <input type="checkbox"/>	

VISUAL APPEARANCE

The product may reveal various wrinkles due to the combination of Elasticity of the covering, characteristics of the interior construction and the design of the product.



Products with Visual Appearance listed as High or Medium would require higher degree of care, where seats and back cushions may require fluffing and plumping more often than Products with Visual Appearance listed as Low.

NOTES

- Designed by Natuzzi Design Center.
- Date of launch: 2024.
- Introducing the new Faraone sofa, it has been inspired by Queen Nefertiti. Queen Nefertiti was an ancient Egyptian queen renowned for her beauty and power. This modular sofa features the profile of Nefertiti's bust on the armrest.
- Use code V309 to order Faraone in all fabric categories currently in our Natuzzi Italia soft covering collection.
- Model available in Misterbianco and Cassidy leathers.
- It offers both motion recliner and non-recliner modules.
- The mechanism of the sofa with a dual motor recliner is very intuitive. With the two buttons on the front part of the control panel, the headrest opens first simultaneously, and once opened, the footrest opens.
- The two buttons on the inner part of the control panel, towards the backrest, allow you to individually control the position of the headrest, tilting it further and bringing it to a more advanced position. This provides better comfort when watching TV, reading a book, or relaxing.

## NOTES

---

- By distributing weight evenly across all pressure points, the zero-gravity power motion system makes you feel weightless. It takes the pressure off your spine and can promote circulation in the legs.  
The definition of Zero Gravity Reclining is the ability for your heart to be resting above your feet which provides proven health benefits.
- The Faraone sofa is also available with a 45-degree corner option and includes in between seat consoles, rectangular or trapezoidal, complete with storage compartments.  
The finish of the table tops is in Matt Chocolate finish.



■ Vers. 072+291+032+274



■ Vers. 072+291+032+274



■ Vers. 072+291+032+274



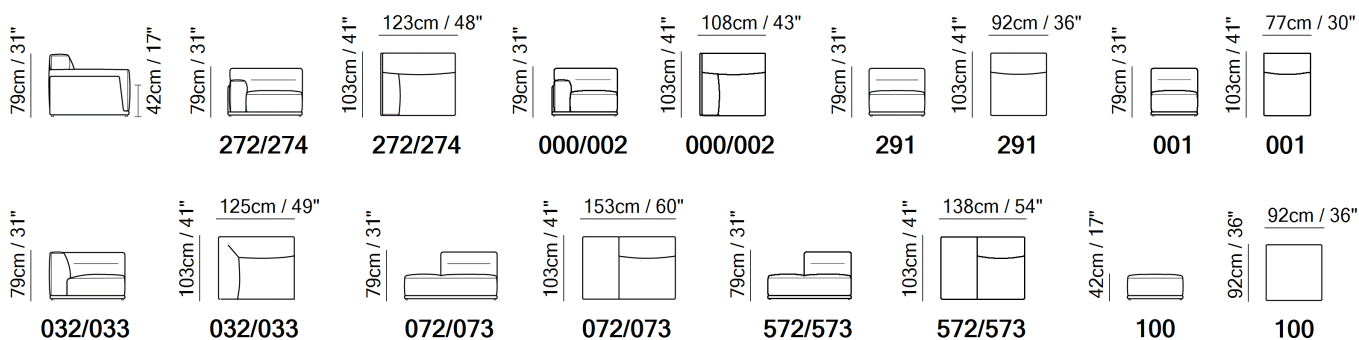

## SCHEMATICS

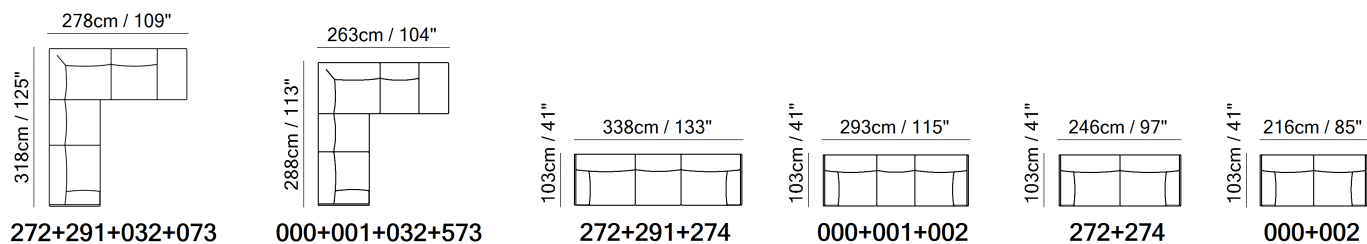

## COMPOSITION EXAMPLES



TECHNICAL INFORMATION

	<b>COVERING</b>	Leather <input checked="" type="checkbox"/>	Soft Cover <input checked="" type="checkbox"/>				
	<b>FILLING</b>	Arms	<input type="checkbox"/> Fiber <input checked="" type="checkbox"/> Foam <input type="checkbox"/> Feather/Fiber Mix <input checked="" type="checkbox"/> Feather	Seat cushion	<input type="checkbox"/> Fiber <input checked="" type="checkbox"/> Foam <input type="checkbox"/> Feather/Fiber Mix <input checked="" type="checkbox"/> Feather	Back cushion	<input type="checkbox"/> Fiber <input checked="" type="checkbox"/> Foam <input type="checkbox"/> Feather/Fiber Mix <input checked="" type="checkbox"/> Feather
	<b>COMFORT</b>	Standard Comfort <input checked="" type="checkbox"/>	Firm Comfort <input type="checkbox"/>				
	<b>FUNCTION</b>	Bed <input type="checkbox"/>	Electric motion <input type="checkbox"/>	Motion <input type="checkbox"/>	Recliner <input type="checkbox"/>	Sliding <input type="checkbox"/>	
	<b>LEGS</b>	Wood <input type="checkbox"/>	Metal <input type="checkbox"/>	Plastic <input checked="" type="checkbox"/>	Castors <input type="checkbox"/>	Upholstered <input type="checkbox"/>	

NOTES

- Designed by Tapinassi & Manzoni.
- Date of launch: 2014.
- Dorian will be the main attraction in your living area. The generously proportioned Dorian sofa is both aesthetically impressive and extremely comfortable.
- Model available in Misterbianco and Cassidy leathers.
- Model is characterized by a special «raw cut stitching» (cut pinched stitching).
- The spacious seats have been ergonomically designed with Memory Foam padding and goose feathers, inclusive of the backrest and arms.
- Seat cushion includes a layer of memory foam, a pressure-sensitive soft polyurethane, that recovers its form completely thus giving great comfort.
- To allow modularity, the single elements can be put together thanks to the rubber stops under the legs.
- Seat and back cushions are fixed to the frame.
- In leather version module side panels are fully upholstered.
- Internal wooden frame.
- With Feet Assembled (the model will be loaded with feet already mounted on the sofa).
- The hidden metal feet have anti-scratch and non-slip rubber, providing a hidden practical solution for protecting floors.
- Feet height 3,0 cm

NOTES

---



■ Vers. 446



■ Vers. 446



■ Vers. 715+029+183



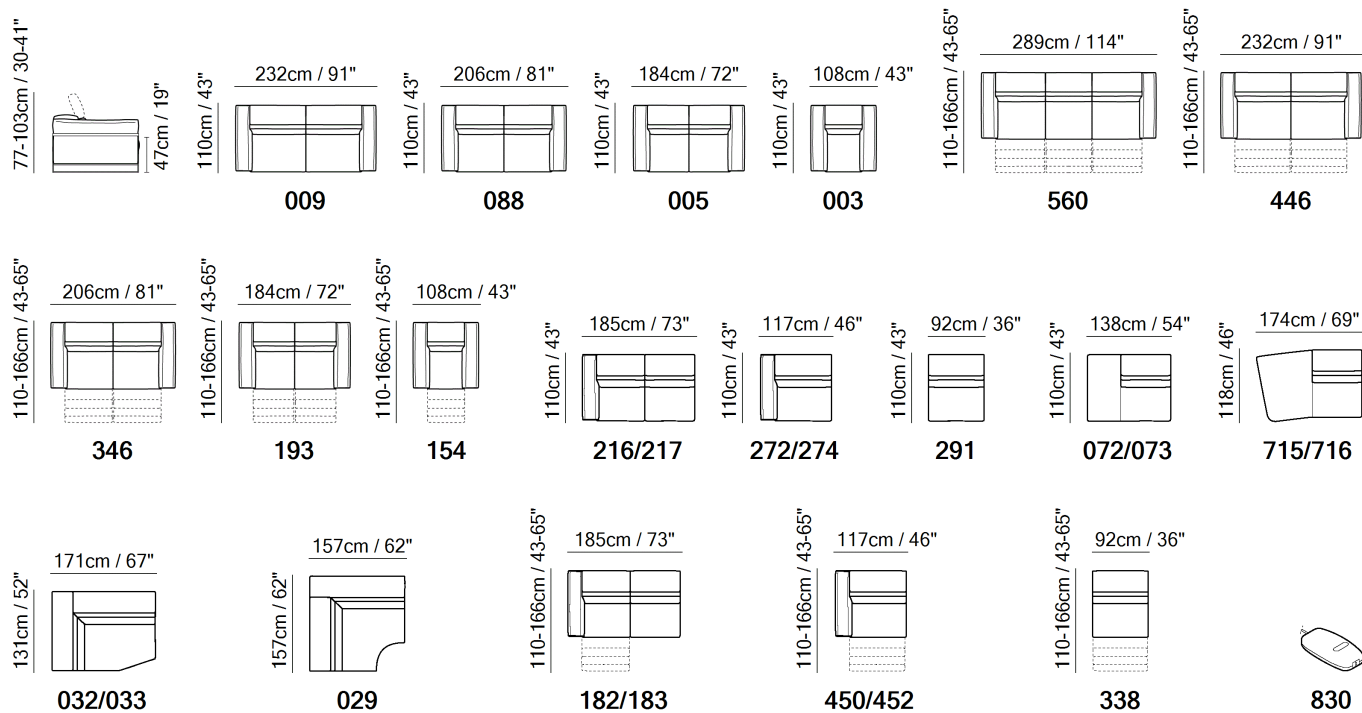

## SCHEMATICS

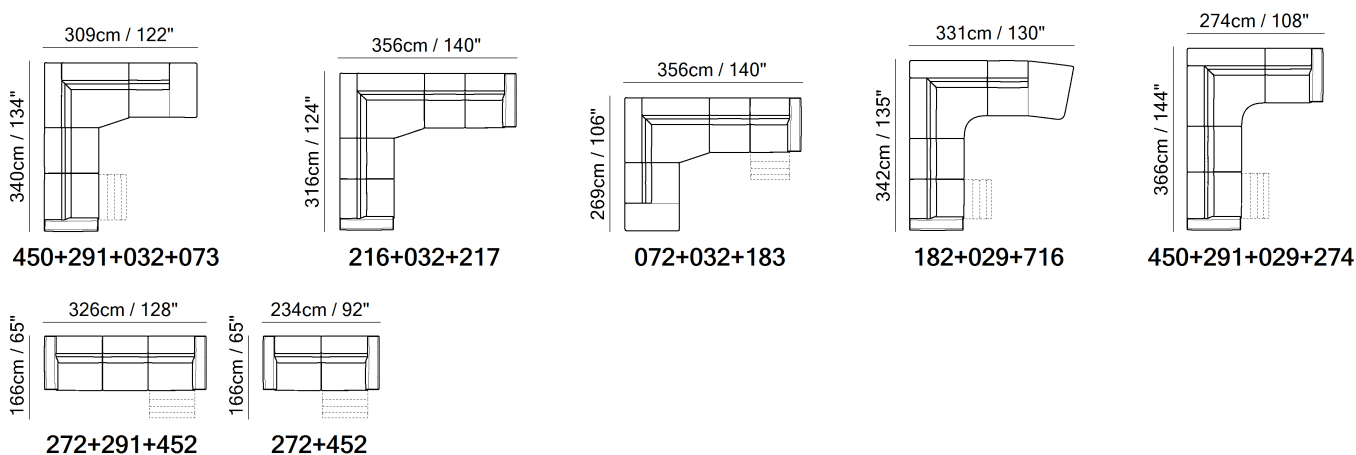

## COMPOSITION EXAMPLES



TECHNICAL INFORMATION

	<b>COVERING</b>	Leather <input checked="" type="checkbox"/>			
	<b>FILLING</b>	Arms	Seat cushion	Back cushion	
		<input type="checkbox"/> Fiber	<input type="checkbox"/> Fiber	<input type="checkbox"/> Fiber	
		<input checked="" type="checkbox"/> Foam	<input checked="" type="checkbox"/> Foam	<input checked="" type="checkbox"/> Foam	
		<input type="checkbox"/> Feather/Fiber Mix	<input type="checkbox"/> Feather/Fiber Mix	<input type="checkbox"/> Feather/Fiber Mix	
		<input type="checkbox"/> Feather	<input type="checkbox"/> Feather	<input type="checkbox"/> Feather	
	<b>COMFORT</b>	Standard Comfort <input checked="" type="checkbox"/>	Firm Comfort <input checked="" type="checkbox"/>		
	<b>FUNCTION</b>	Bed <input type="checkbox"/>	Electric motion <input checked="" type="checkbox"/>	Motion <input checked="" type="checkbox"/>	Recliner <input checked="" type="checkbox"/>
					Sliding <input type="checkbox"/>
	<b>LEGS</b>	Wood <input type="checkbox"/>	Plastic <input type="checkbox"/>	Metal <input checked="" type="checkbox"/>	Upholstered <input type="checkbox"/>
					Castors <input type="checkbox"/>

NOTES

- Designed by Maurizio Manzoni.
- Date of launch: 2014.
- Boasting superior structure and optional high-tech relax systems, Fidelio's feature armrests are embellished by "pinched" piping and held in a metal frame which defines the outline of the sofa.
- Model available in Misterbianco and Cassidy leathers.
- Model is characterized by a special «raw cut stitching» (cut pinched stitching).
- Available with Soft Touch mechanism that changes the seat and back cushion position with a simple tap.
- Model has power combined headrest. ATTENTION! The headrest opens first followed by the footrest; then the headrest has one final extra rotation for comfortable TV watching position.
- Thanks to ZeroWall mechanism, seat and back cushions can be reclined at a great length without moving sofa away from the wall.
- Adjustable headrest on all versions.
- Stationary versions have manually adjustable headrests.
- Version 560, a three seater sofa where each seat has its own electric mechanism.
- Seat cushion includes a layer of memory foam, a pressure-sensitive soft polyurethane, that recovers its form completely thus giving great comfort.
- A battery pack can be ordered with its own version code 830. For order entry please use XX for category and XXX for cover code. In order to optimize the duration of the battery, it is suggested to order one per each motion seat.
- Tight Back Cushion (the back cushions of the models are fixed to the frame)
- Internal wooden frame.

## NOTES

---

- With Feet Assembled (the model will be loaded with feet already mounted on the sofa).
- Feet available in metal finishings 74 (Graphite Grey Rough) / 75 (Glazed Nickel) / 78 (Black Chrome)
- Feet height 11,0 cm



■ Vers. 272+291+274



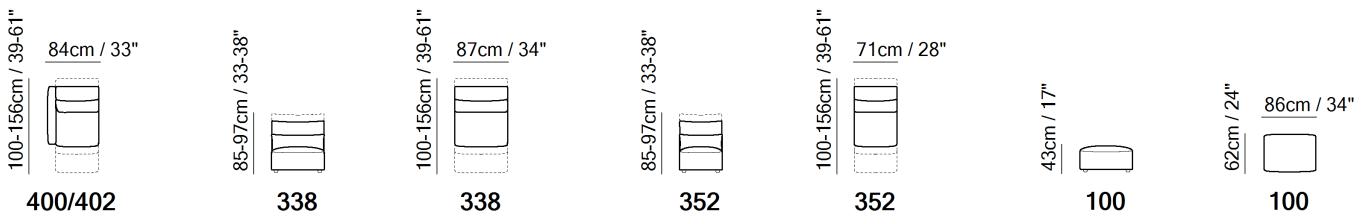
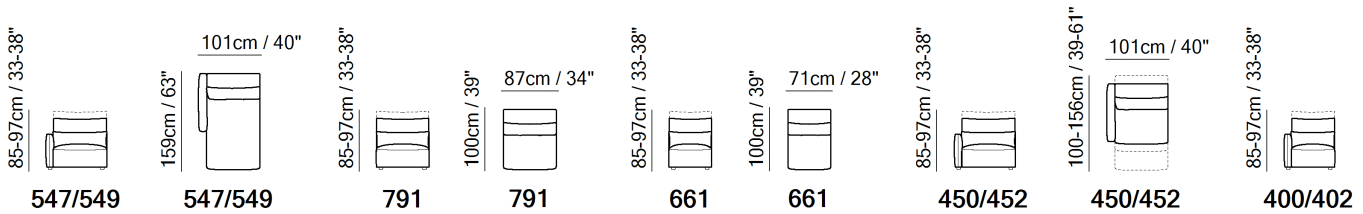
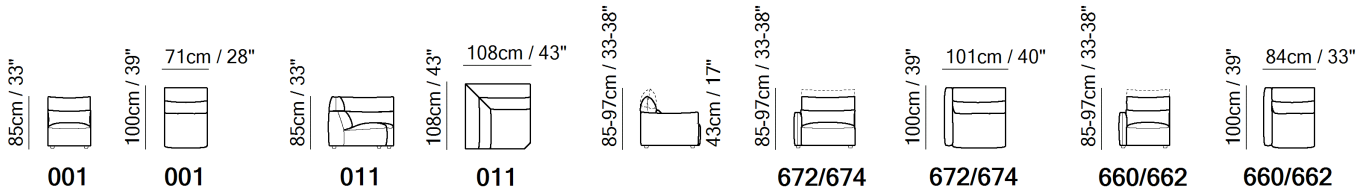
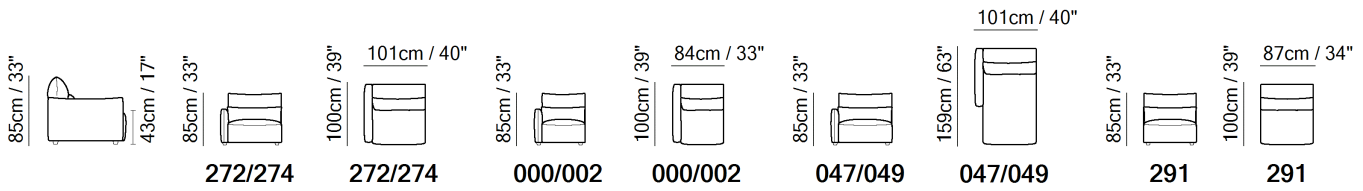

SCHEMATICS

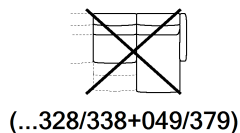
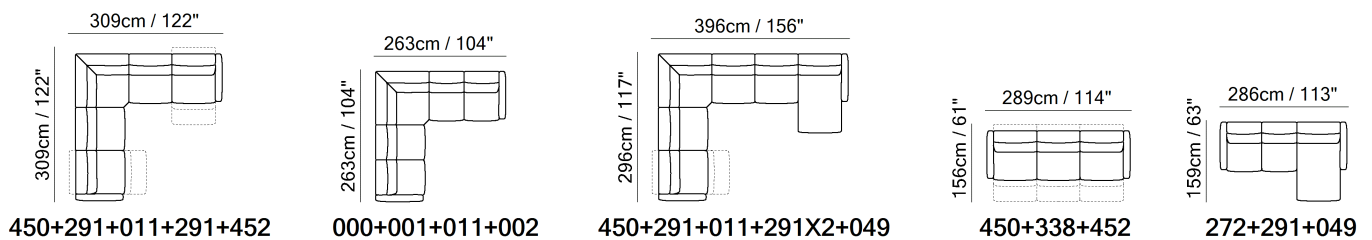

COMPOSITION EXAMPLES



TECHNICAL INFORMATION

	<b>COVERING</b>	Soft Cover <input checked="" type="checkbox"/>									
	<b>FILLING</b>	Arms	<input type="checkbox"/> Fiber <input checked="" type="checkbox"/> Foam <input type="checkbox"/> Feather/Fiber Mix <input type="checkbox"/> Feather	Seat cushion	<input type="checkbox"/> Fiber <input checked="" type="checkbox"/> Foam <input type="checkbox"/> Feather/Fiber Mix <input type="checkbox"/> Feather	Back cushion	<input type="checkbox"/> Fiber <input checked="" type="checkbox"/> Foam <input type="checkbox"/> Feather/Fiber Mix <input type="checkbox"/> Feather				
	<b>COMFORT</b>	Standard Comfort	<input checked="" type="checkbox"/>				Firm Comfort	<input type="checkbox"/>			
	<b>FUNCTION</b>	Bed	<input type="checkbox"/>	Electric motion	<input checked="" type="checkbox"/>	Motion	<input checked="" type="checkbox"/>	Recliner	<input type="checkbox"/>	Sliding	<input type="checkbox"/>
	<b>LEGS</b>	Wood	<input type="checkbox"/>	Metal	<input type="checkbox"/>	Plastic	<input checked="" type="checkbox"/>	Castors	<input type="checkbox"/>	Upholstered	<input type="checkbox"/>

NOTES

- Designed by Natuzzi Design Center.
- Date of launch: 2017.
- An authentic galaxy of comfort, design and innovation. An enveloping design is combined with extreme modularity, space-saving features and a latest-generation recliner, allowing you to activate the headrest and footrest on each seat to obtain the desired position.
- To allow modularity, the single elements can be put together thanks to the rubber stops under the legs.
- FABRIC: In fabric contrast welt (as well as any another decorative detail such as a band under arm cushion or backrest or inserts) can be made with any color of art. Le Mans.
- Dual power mechanism with internal seat buttons (recliner and power headrest lift with manual adjustable tilt position)
- Switch is located internally between arm and seat, that activates recliner and headrest lift separately.
- Thanks to ZeroWall mechanism, seat and back cushions can be reclined at a great length without moving sofa away from the wall.
- A battery pack can be ordered with its own version code 830. For order entry please use XX for category and XXX for cover code. In order to optimize the duration of the battery, it is suggested to order one per each motion seat.
- Seat and back cushions are fixed to the frame.
- Internal wooden frame.
- Feet will be in a bag inside the package and requires assembling.

**NOTES**

---



■ Vers. 272+291+274



■ Vers. 272+029+291+274



■ Vers. 272+291+049



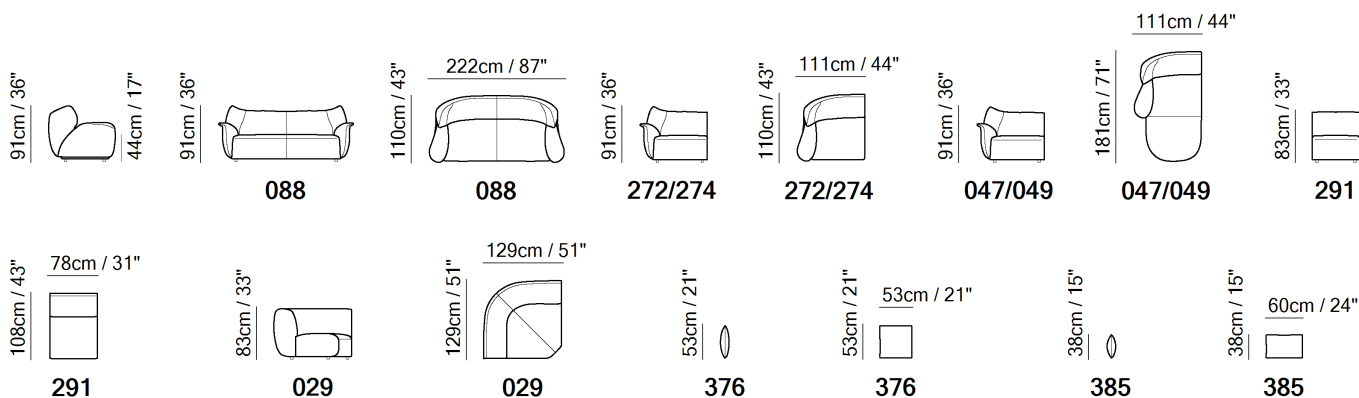

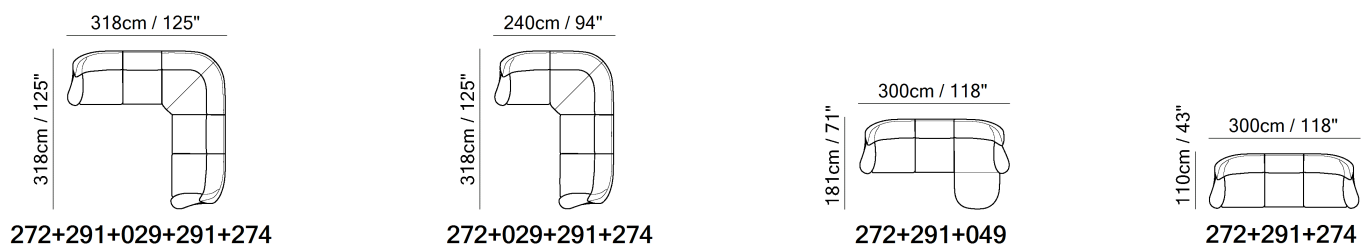

## SCHEMATICS



## COMPOSITION EXAMPLES



TECHNICAL INFORMATION

	<b>COVERING</b>	Leather <input checked="" type="checkbox"/>	Soft Cover <input checked="" type="checkbox"/>				
	<b>FILLING</b>	Arms	<input type="checkbox"/> Fiber <input type="checkbox"/> Foam <input type="checkbox"/> Feather/Fiber Mix <input type="checkbox"/> Feather	Seat cushion	<input type="checkbox"/> Fiber <input type="checkbox"/> Foam <input type="checkbox"/> Feather/Fiber Mix <input type="checkbox"/> Feather	Back cushion	<input type="checkbox"/> Fiber <input type="checkbox"/> Foam <input type="checkbox"/> Feather/Fiber Mix <input type="checkbox"/> Feather
	<b>COMFORT</b>	Standard Comfort <input checked="" type="checkbox"/>	Firm Comfort <input type="checkbox"/>				
	<b>FUNCTION</b>	Bed <input type="checkbox"/>	Electric motion <input type="checkbox"/>	Motion <input type="checkbox"/>	Recliner <input type="checkbox"/>	Sliding <input type="checkbox"/>	
	<b>VISUAL APPEARANCE*</b>	Low <input type="checkbox"/>	Medium <input type="checkbox"/>	High <input checked="" type="checkbox"/>			
	<b>LEGS</b>	Wood <input type="checkbox"/>	Plastic <input type="checkbox"/>	Metal <input type="checkbox"/>	Upholstered <input type="checkbox"/>	Castors <input type="checkbox"/>	

VISUAL APPEARANCE

The product may reveal various wrinkles due to the combination of Elasticity of the covering, characteristics of the interior construction and the design of the product.



Products with Visual Appearance listed as High or Medium would require higher degree of care, where seats and back cushions may require fluffing and plumping more often than Products with Visual Appearance listed as Low.

NOTES

- In leather the model is available starting from cat. 25 (Status).
- Model is not available with article Misterbianco (cat. 30).
- Curved wooden structure.
- Elastic straps that give support and greater comfort.
- Being modular and having a wooden structure, it is much less heavy than the 3230 version which has a molded polyurethane foam structure.
- Absolute comfortable seat cushions thanks to a new polyurethane foam with high density (50).
- 4cm hidden metal feet with anti-scratch and non-slip rubbers.

NOTES

---



■ Vers. 009



■ Vers. 586



■ Vers. 018+049



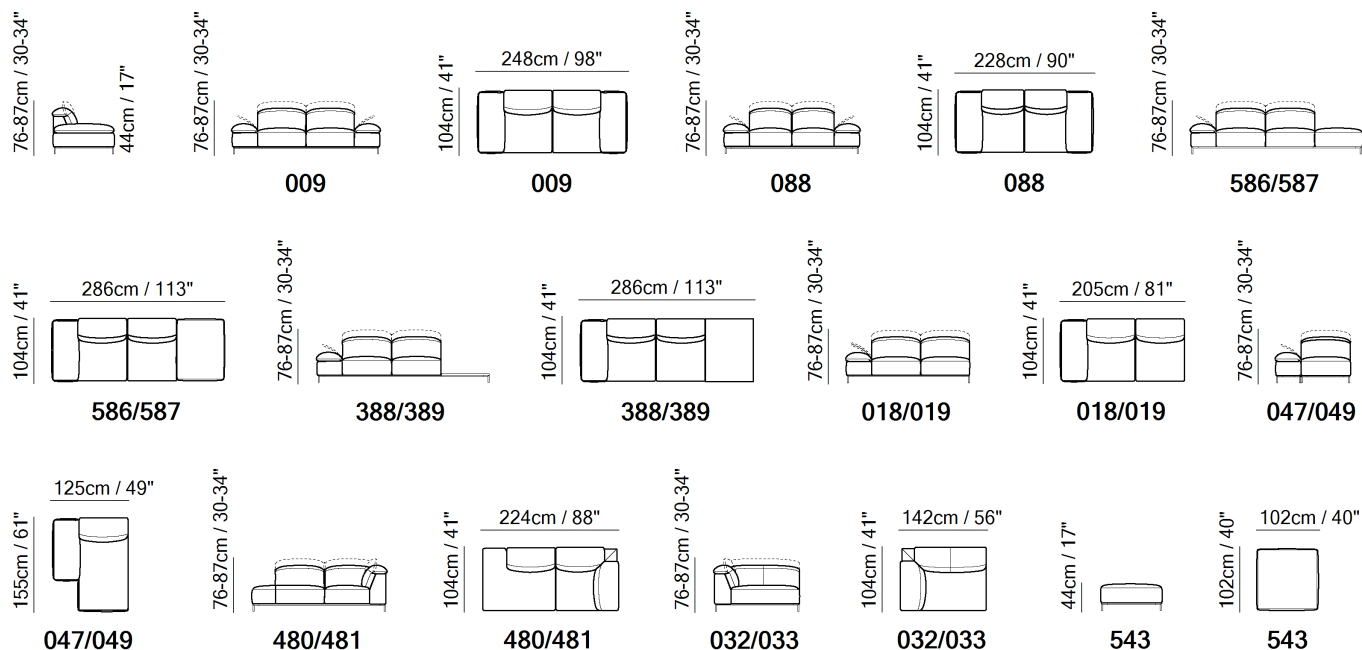

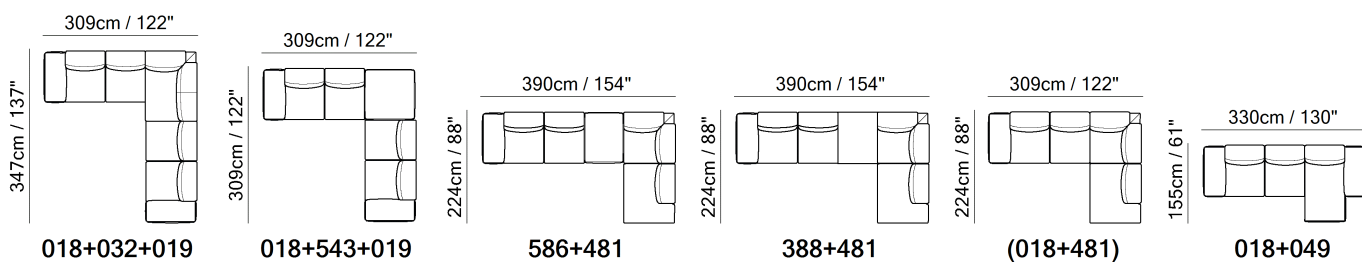

**SCHEMATICS**



**COMPOSITION EXAMPLES**



TECHNICAL INFORMATION

	<b>COVERING</b>	Leather <input checked="" type="checkbox"/>	Soft Cover <input checked="" type="checkbox"/>				
	<b>FILLING</b>	Arms	<input type="checkbox"/> Fiber <input checked="" type="checkbox"/> Foam <input type="checkbox"/> Feather/Fiber Mix <input type="checkbox"/> Feather	Seat cushion	<input type="checkbox"/> Fiber <input checked="" type="checkbox"/> Foam <input type="checkbox"/> Feather/Fiber Mix <input type="checkbox"/> Feather	Back cushion	<input type="checkbox"/> Fiber <input checked="" type="checkbox"/> Foam <input type="checkbox"/> Feather/Fiber Mix <input type="checkbox"/> Feather
	<b>COMFORT</b>	Standard Comfort <input checked="" type="checkbox"/>	Firm Comfort <input type="checkbox"/>				
	<b>FUNCTION</b>	Bed <input type="checkbox"/>	Electric motion <input type="checkbox"/>	Motion <input type="checkbox"/>	Recliner <input type="checkbox"/>	Sliding <input type="checkbox"/>	
	<b>VISUAL APPEARANCE*</b>	Low <input checked="" type="checkbox"/>	Medium <input type="checkbox"/>	High <input type="checkbox"/>			
	<b>LEGS</b>	Wood <input type="checkbox"/>	Metal <input type="checkbox"/>	Plastic <input type="checkbox"/>	Castors <input type="checkbox"/>	Upholstered <input type="checkbox"/>	

VISUAL APPEARANCE

The product may reveal various wrinkles due to the combination of Elasticity of the covering, characteristics of the interior construction and the design of the product.



Products with Visual Appearance listed as High or Medium would require higher degree of care, where seats and back cushions may require fluffing and plumping more often than Products with Visual Appearance listed as Low.

NOTES

- Designed by Marcel Wanders Studio.
- Date of launch: 2022.
- In leather the model is available starting from cat. 15 (Le Mans).
- Model not available in Misterbianco and Cassidy leathers.
- Seat cushion includes a layer of memory foam, a pressure-sensitive soft polyurethane, that recovers its form completely thus giving great comfort.
- Microcellular polyurethane foam padding made from a plant based raw material, drawing from renewable sources found in nature.
- Such padding meets the demands of a market that is increasingly sensitive to products with a low environmental impact and ensures maximum comfort, thanks to high production technology and the high quality of the raw materials from which it is made. The seat is composed of polyurethane foam with density 50 combined with a layer of memory foam 2 cm high.
- Adjustable headrest on all versions.
- Adjustable armrest in several positions with click mechanism in the opening phase and frictioned mechanism in the closing phase.
- Feet available in metal finishings 73 (Matt Brick) / 79 (Matt Black)
- Model available with wooden base to order as 3242.

NOTES

---



■ Vers. Q00+045+Q25+Q02



■ Vers. 274+045+Q25+045+Q02



■ Vers. 816+274+045+821+Q25+045+Q02



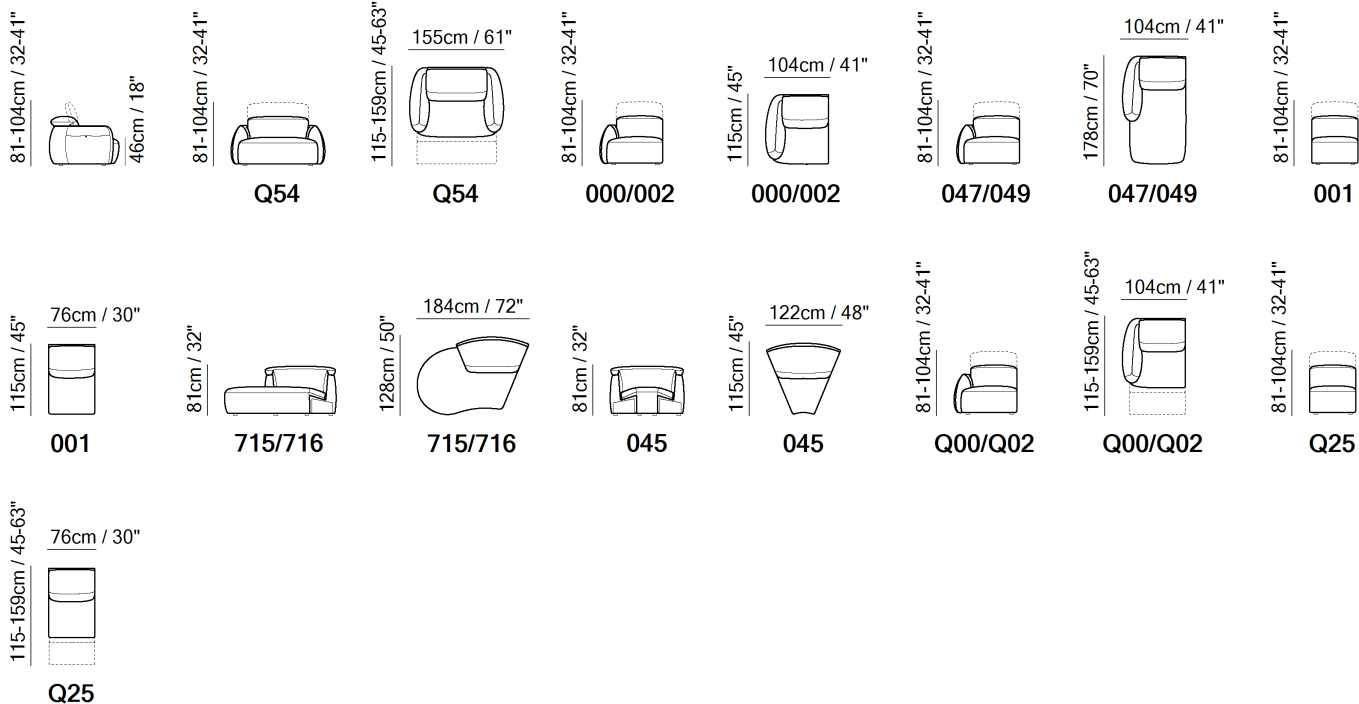



## SCHEMATICS



## COMPOSITION EXAMPLES



TECHNICAL INFORMATION

	<b>COVERING</b>	Leather <input checked="" type="checkbox"/>	Soft Cover <input checked="" type="checkbox"/>				
	<b>FILLING</b>	Arms	<input type="checkbox"/> Fiber <input checked="" type="checkbox"/> Foam <input type="checkbox"/> Feather/Fiber Mix <input type="checkbox"/> Feather	Seat cushion	<input type="checkbox"/> Fiber <input checked="" type="checkbox"/> Foam <input type="checkbox"/> Feather/Fiber Mix <input type="checkbox"/> Feather	Back cushion	<input type="checkbox"/> Fiber <input checked="" type="checkbox"/> Foam <input type="checkbox"/> Feather/Fiber Mix <input type="checkbox"/> Feather
	<b>COMFORT</b>	Standard Comfort <input checked="" type="checkbox"/>	Firm Comfort <input type="checkbox"/>				
	<b>FUNCTION</b>	Bed <input type="checkbox"/>	Electric motion <input type="checkbox"/>	Motion <input type="checkbox"/>	Recliner <input type="checkbox"/>	Sliding <input type="checkbox"/>	
	<b>VISUAL APPEARANCE*</b>	Low <input type="checkbox"/>	Medium <input type="checkbox"/>	High <input checked="" type="checkbox"/>			
	<b>LEGS</b>	Wood <input type="checkbox"/>	Plastic <input type="checkbox"/>	Metal <input type="checkbox"/>	Upholstered <input type="checkbox"/>	Castors <input type="checkbox"/>	

VISUAL APPEARANCE

The product may reveal various wrinkles due to the combination of Elasticity of the covering, characteristics of the interior construction and the design of the product.



Products with Visual Appearance listed as High or Medium would require higher degree of care, where seats and back cushions may require fluffing and plumping more often than Products with Visual Appearance listed as Low.

NOTES

NOTES

---



■ Vers. 272+274



■ Vers. 272+291+274



■ Vers. 272+291+045+823+274



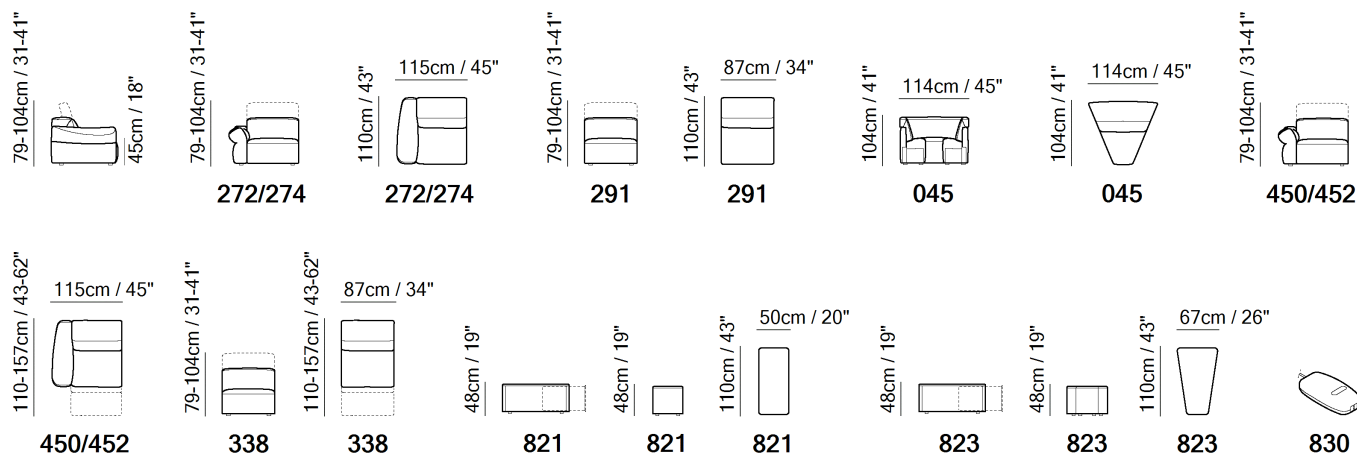

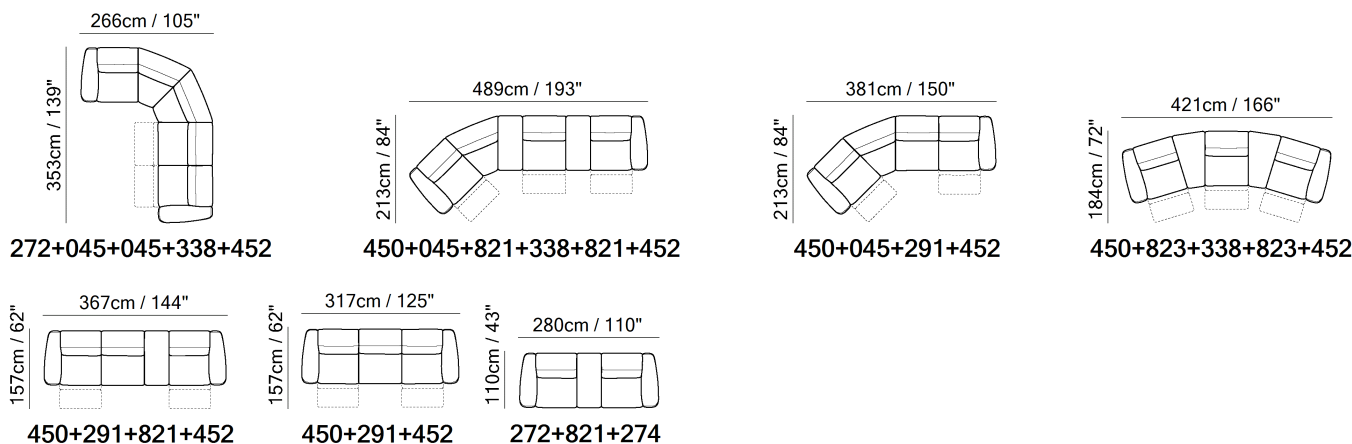

SCHEMATICS



COMPOSITION EXAMPLES



TECHNICAL INFORMATION

	<b>COVERING</b>	Soft Cover <input checked="" type="checkbox"/>					
	<b>FILLING</b>	Arms	<input type="checkbox"/> Fiber <input checked="" type="checkbox"/> Foam <input type="checkbox"/> Feather/Fiber Mix <input type="checkbox"/> Feather	Seat cushion	<input type="checkbox"/> Fiber <input checked="" type="checkbox"/> Foam <input type="checkbox"/> Feather/Fiber Mix <input type="checkbox"/> Feather	Back cushion	<input type="checkbox"/> Fiber <input checked="" type="checkbox"/> Foam <input type="checkbox"/> Feather/Fiber Mix <input type="checkbox"/> Feather
	<b>COMFORT</b>	Standard Comfort <input checked="" type="checkbox"/>	Firm Comfort <input type="checkbox"/>				
	<b>FUNCTION</b>	Bed <input type="checkbox"/>	Electric motion <input checked="" type="checkbox"/>	Motion <input type="checkbox"/>	Recliner <input type="checkbox"/>	Sliding <input type="checkbox"/>	
	<b>VISUAL APPEARANCE*</b>	Low <input type="checkbox"/>	Medium <input checked="" type="checkbox"/>	High <input type="checkbox"/>			
	<b>LEGS</b>	Wood <input type="checkbox"/>	Metal <input type="checkbox"/>	Plastic <input type="checkbox"/>	Castors <input type="checkbox"/>	Upholstered <input type="checkbox"/>	

VISUAL APPEARANCE

The product may reveal various wrinkles due to the combination of Elasticity of the covering, characteristics of the interior construction and the design of the product.



Products with Visual Appearance listed as High or Medium would require higher degree of care, where seats and back cushions may require fluffing and plumping more often than Products with Visual Appearance listed as Low.

NOTES

- Designed by Natuzzi Design Center.
- Date of launch: 2024.
- Introducing the new Faraone sofa, it has been inspired by Queen Nefertiti. Queen Nefertiti was an ancient Egyptian queen renowned for her beauty and power. This modular sofa features the profile of Nefertiti's bust on the armrest.
- Use code V309 to order Faraone in all fabric categories currently in our Natuzzi Italia soft covering collection.
- The first covering is the main fabric where the second covering is the contrast leather insert available in CAT 15 Le Mans, CAT 25 Status, CAT 30 Stromboli, CAT 40 Siena
- It offers both motion recliner and non-recliner modules.
- The mechanism of the sofa with a dual motor recliner is very intuitive. With the two buttons on the front part of the control panel, the headrest opens first simultaneously, and once opened, the footrest opens.
- The two buttons on the inner part of the control panel, towards the backrest, allow you to individually control the position of the headrest, tilting it further and bringing it to a more advanced position. This provides better comfort when watching TV, reading a book, or relaxing.

## NOTES

---

- By distributing weight evenly across all pressure points, the zero-gravity power motion system makes you feel weightless. It takes the pressure off your spine and can promote circulation in the legs.  
The definition of Zero Gravity Reclining is the ability for your heart to be resting above your feet which provides proven health benefits.
- The Faraone sofa is also available with a 45-degree corner option and includes in between seat consoles, rectangular or trapezoidal, complete with storage compartments.  
The finish of the table tops is in Matt Chocolate finish.



■ Vers. 047+017



■ Vers. 047+017



■ Vers. 047+017



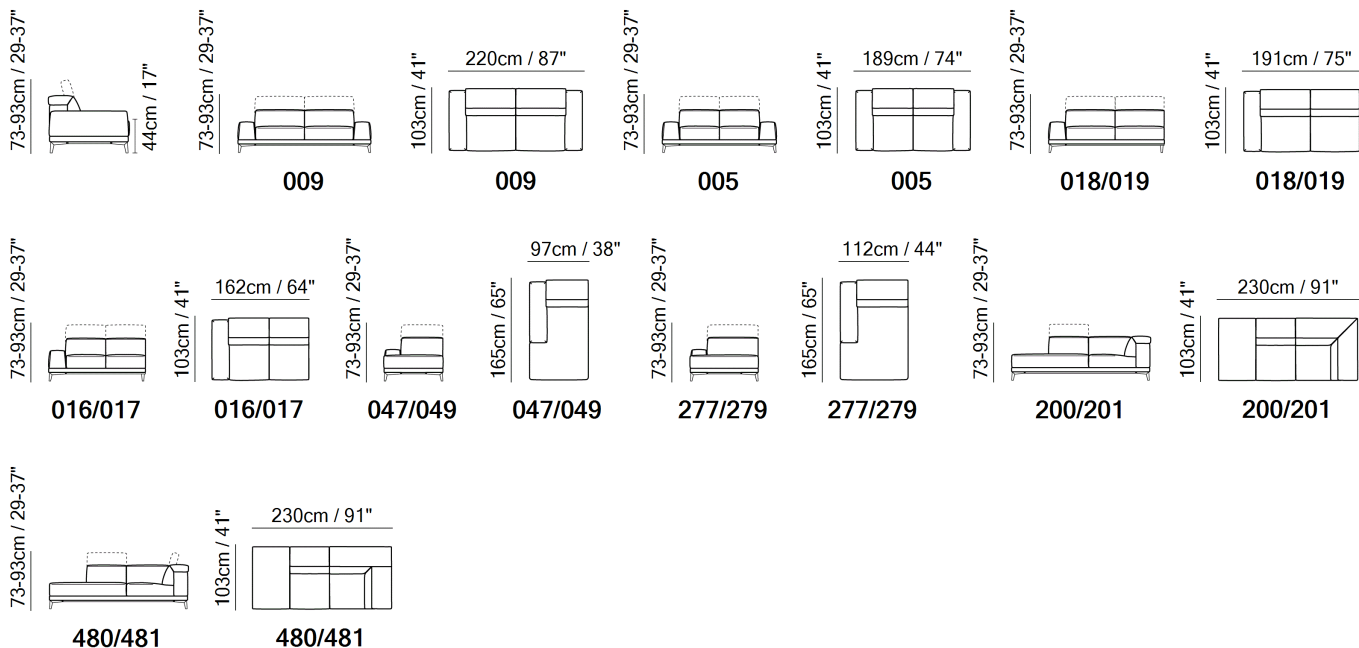

SCHEMATICS

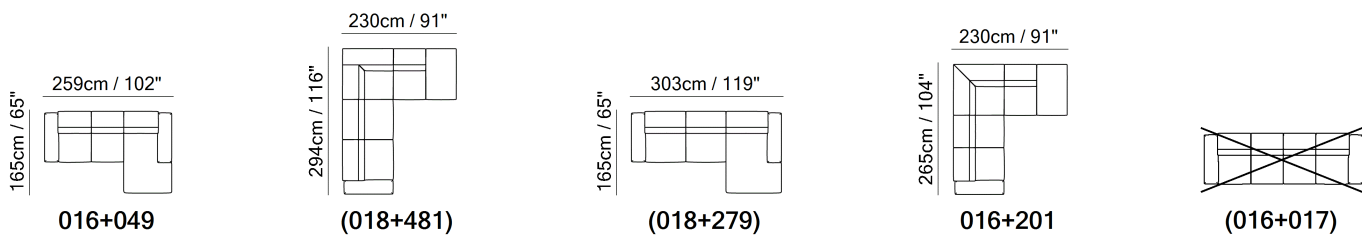

COMPOSITION EXAMPLES



TECHNICAL INFORMATION

	<b>COVERING</b>	Leather <input checked="" type="checkbox"/>	Soft Cover <input checked="" type="checkbox"/>				
	<b>FILLING</b>	Arms	<input type="checkbox"/> Fiber <input checked="" type="checkbox"/> Foam <input type="checkbox"/> Feather/Fiber Mix <input type="checkbox"/> Feather	Seat cushion	<input type="checkbox"/> Fiber <input checked="" type="checkbox"/> Foam <input type="checkbox"/> Feather/Fiber Mix <input type="checkbox"/> Feather	Back cushion	<input type="checkbox"/> Fiber <input checked="" type="checkbox"/> Foam <input type="checkbox"/> Feather/Fiber Mix <input type="checkbox"/> Feather
	<b>COMFORT</b>	Standard Comfort <input checked="" type="checkbox"/>	Firm Comfort <input type="checkbox"/>				
	<b>FUNCTION</b>	Bed <input type="checkbox"/>	Electric motion <input type="checkbox"/>	Motion <input type="checkbox"/>	Recliner <input type="checkbox"/>	Sliding <input type="checkbox"/>	
	<b>LEGS</b>	Wood <input type="checkbox"/>	Plastic <input type="checkbox"/>	Metal <input checked="" type="checkbox"/>	Upholstered <input type="checkbox"/>	Castors <input type="checkbox"/>	

NOTES

- A sophisticated design, boasting soft shapes and adjustable headrests for superb comfort without compromising style.
- Model is not available with article Misterbianco (cat. 30).
- Adjustable headrest on all versions.
- Versions 200/201 have one adjustable headrest on the terminal back
- Second option versions 480/481 have 2 adjustable headrests on the left and right terminal backs
- Second option versions of chaise longue (277/279) are wider in respect to standard (047/049).
- Seat cushion includes a layer of memory foam, a pressure-sensitive soft polyurethane, that recovers its form completely thus giving great comfort.
- Tight Seat Cushion (the seat cushions of the models are fixed to the frame)
- Tight Back Cushion (the back cushions of the models are fixed to the frame)
- With Leather Side (the sectional pieces come with leather sides)
- Internal wooden frame.
- Feet will be in a bag inside the package and requires assembling.
- Model available with wooden base to order as 2826
- Metal base available in metal finishings 75 (Glazed Nickel) / 78 (Black Chrome)
- Feet height 16,0 cm

NOTES

---



■ Vers. 003



■ Vers. 009



■ Vers. 272+291+032+291+049

SCHEMATICS

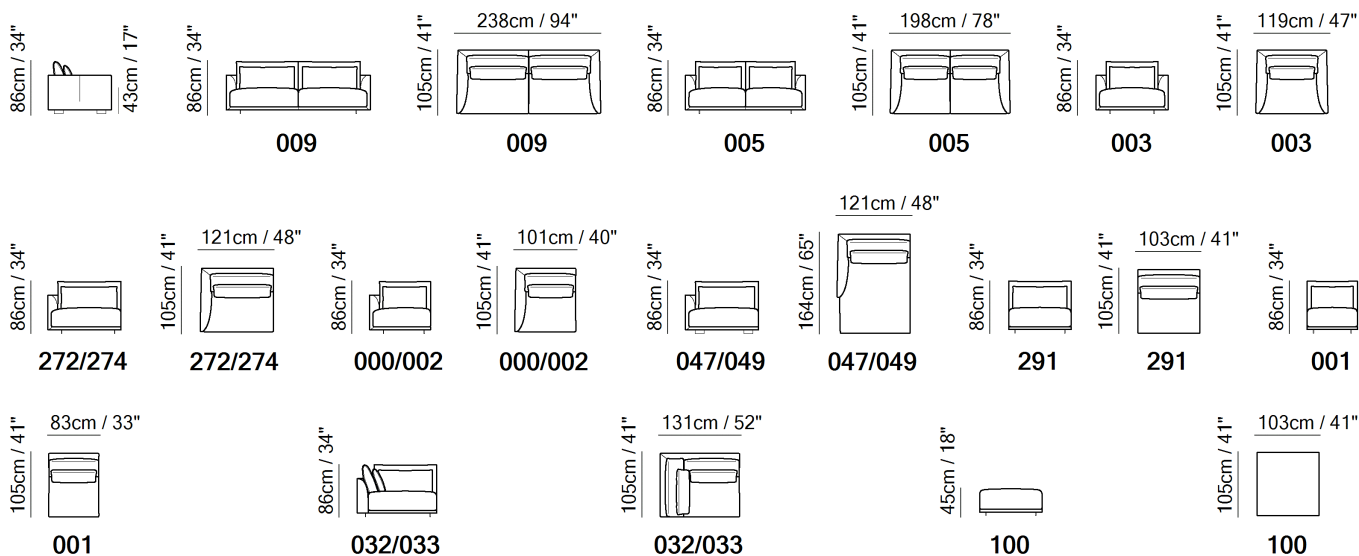



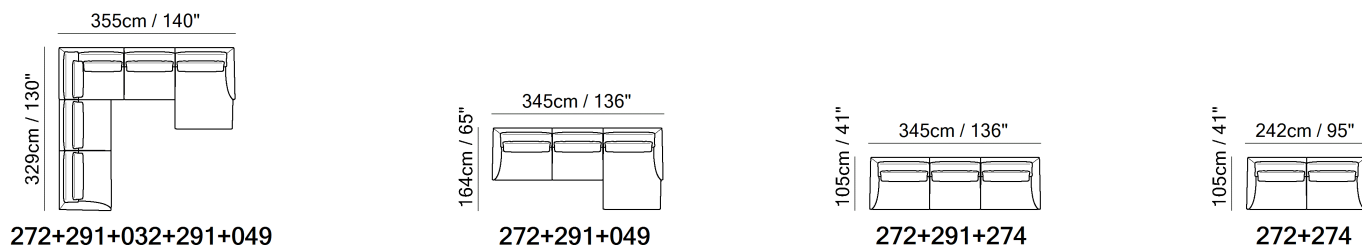

COMPOSITION EXAMPLES



**TECHNICAL INFORMATION**

---

	<b>COVERING</b>	Leather <input checked="" type="checkbox"/>	Soft Cover <input checked="" type="checkbox"/>				
	<b>FILLING</b>	Arms	<input type="checkbox"/> Fiber <input checked="" type="checkbox"/> Foam <input type="checkbox"/> Feather/Fiber Mix <input type="checkbox"/> Feather	Seat cushion	<input type="checkbox"/> Fiber <input checked="" type="checkbox"/> Foam <input type="checkbox"/> Feather/Fiber Mix <input type="checkbox"/> Feather	Back cushion	<input type="checkbox"/> Fiber <input checked="" type="checkbox"/> Foam <input type="checkbox"/> Feather/Fiber Mix <input type="checkbox"/> Feather
	<b>COMFORT</b>	Standard Comfort <input checked="" type="checkbox"/>	Firm Comfort <input type="checkbox"/>				
	<b>FUNCTION</b>	Bed <input type="checkbox"/>	Electric motion <input type="checkbox"/>	Motion <input type="checkbox"/>	Recliner <input type="checkbox"/>	Sliding <input type="checkbox"/>	
	<b>LEGS</b>	Wood <input type="checkbox"/>	Metal <input type="checkbox"/>	Plastic <input type="checkbox"/>	Castors <input type="checkbox"/>	Upholstered <input type="checkbox"/>	

**NOTES**

---

NOTES

---



■ Vers. 272+291+032+291+049



■ Vers. 272+291+049



■ Vers. 272+291+049+556



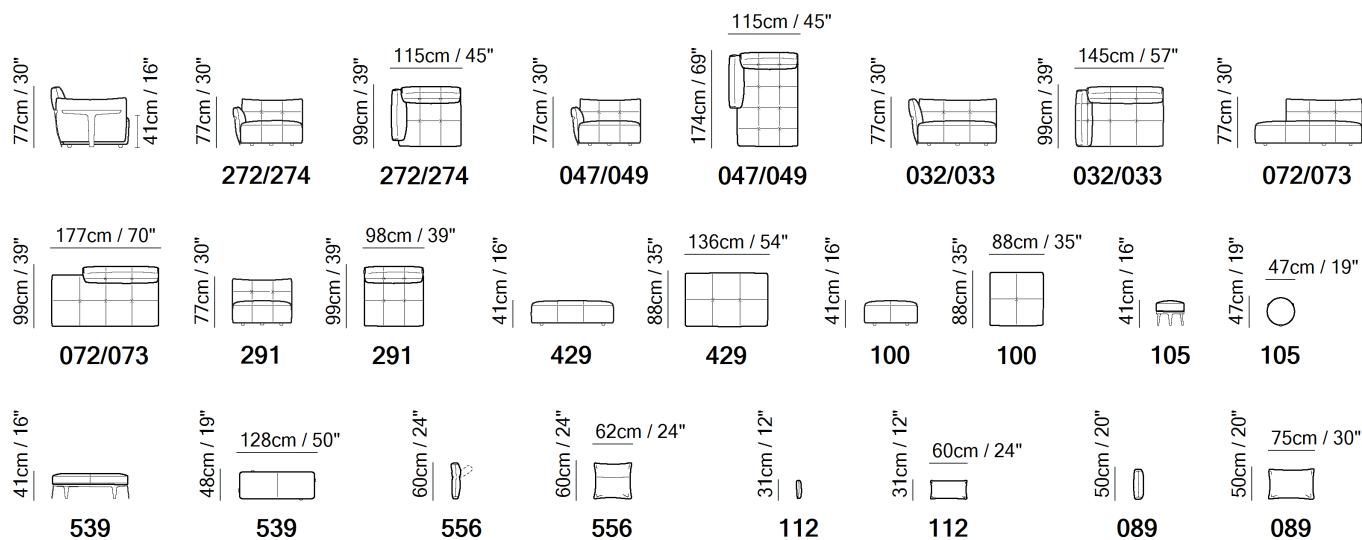

## SCHEMATICS

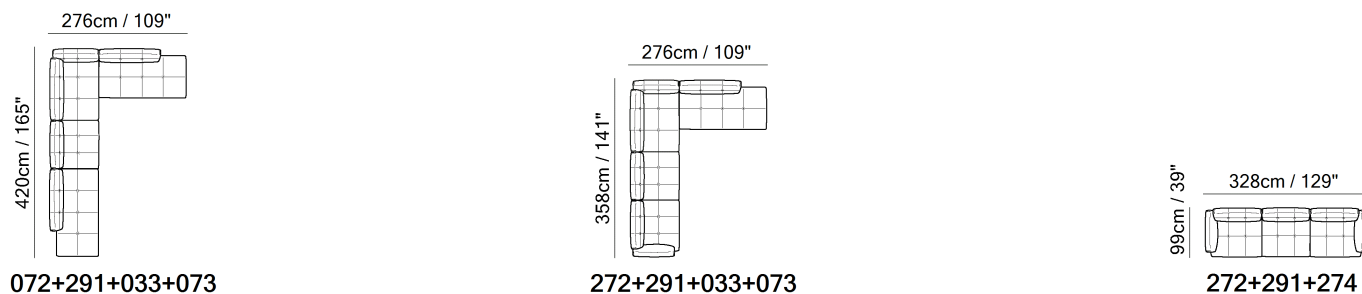

## COMPOSITION EXAMPLES



TECHNICAL INFORMATION

	<b>COVERING</b>	Leather <input checked="" type="checkbox"/>				
	<b>FILLING</b>	<b>Arms</b> <input type="checkbox"/> Fiber <input checked="" type="checkbox"/> Foam <input type="checkbox"/> Feather/Fiber Mix <input checked="" type="checkbox"/> Feather	<b>Seat cushion</b> <input type="checkbox"/> Fiber <input checked="" type="checkbox"/> Foam <input type="checkbox"/> Feather/Fiber Mix <input checked="" type="checkbox"/> Feather	<b>Back cushion</b> <input type="checkbox"/> Fiber <input checked="" type="checkbox"/> Foam <input type="checkbox"/> Feather/Fiber Mix <input checked="" type="checkbox"/> Feather		
	<b>COMFORT</b>	Standard Comfort <input checked="" type="checkbox"/>	Firm Comfort <input type="checkbox"/>			
	<b>FUNCTION</b>	Bed <input type="checkbox"/>	Electric motion <input type="checkbox"/>	Motion <input type="checkbox"/>	Recliner <input type="checkbox"/>	Sliding <input type="checkbox"/>
	<b>LEGS</b>	Wood <input type="checkbox"/>	Plastic <input checked="" type="checkbox"/>	Metal <input type="checkbox"/>	Upholstered <input type="checkbox"/>	Castors <input type="checkbox"/>

NOTES

- The Herman sofa, designed by architects Manzoni and Tapinassi, features deep, comfortable seats equipped with chaise-longue end units that allow you to comfortably lie down.
- The backrests are decorated with matching cushions, while the armrests emphasize the essential design of the sofa, enhanced by the presence of extremely elegant stitching.
- The backrests are decorated with matching cushions, while the armrests emphasize the essential design of the sofa, enhanced by the presence of extremely elegant stitching.
- To allow modularity, the single elements can be put together thanks to the rubber stops under the legs.
- Model Herman (V981) can be ordered in fabric using code 2981. In fabric, aesthetics of the sofa are completely different.
- Model available with articles Le Mans, Status, Stromboli and Siena.
- Seat cushion includes a layer of memory foam, a pressure-sensitive soft polyurethane, that recovers its form completely thus giving great comfort.
- Tight Seat Cushion (the seat cushions of the models are fixed to the frame)
- Tight Back Cushion (the back cushions of the models are fixed to the frame)
- With Leather Side (the sectional pieces come with leather sides)
- Internal wooden frame.
- With Feet Assembled (the model will be loaded with feet already mounted on the sofa).
- Metal spine available in metal finishings 80 (pewter) and 81 (glazed bronze)

NOTES

---



■ Vers.



■ Vers.



■ Vers.



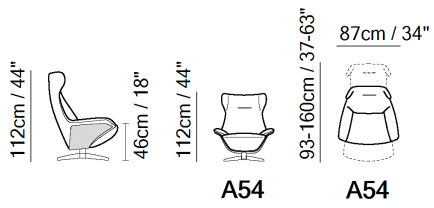

## SCHEMATICS

---



## TECHNICAL INFORMATION

---

	<b>COVERING</b>	Leather <input checked="" type="checkbox"/>	Soft Cover <input checked="" type="checkbox"/>				
	<b>FILLING</b>	Arms	<input type="checkbox"/> Fiber <input type="checkbox"/> Foam <input type="checkbox"/> Feather/Fiber Mix <input type="checkbox"/> Feather	Seat cushion	<input type="checkbox"/> Fiber <input type="checkbox"/> Foam <input type="checkbox"/> Feather/Fiber Mix <input type="checkbox"/> Feather	Back cushion	<input type="checkbox"/> Fiber <input type="checkbox"/> Foam <input type="checkbox"/> Feather/Fiber Mix <input type="checkbox"/> Feather
	<b>COMFORT</b>	Standard Comfort <input checked="" type="checkbox"/>	Firm Comfort <input type="checkbox"/>				
	<b>FUNCTION</b>	Bed <input type="checkbox"/>	Electric motion <input type="checkbox"/>	Motion <input type="checkbox"/>	Recliner <input type="checkbox"/>	Sliding <input type="checkbox"/>	
	<b>LEGS</b>	Wood <input type="checkbox"/>	Metal <input type="checkbox"/>	Plastic <input type="checkbox"/>	Castors <input type="checkbox"/>	Upholstered <input type="checkbox"/>	

## NOTES

---

NOTES

---