



■ Vers. 703



■ Vers. 713





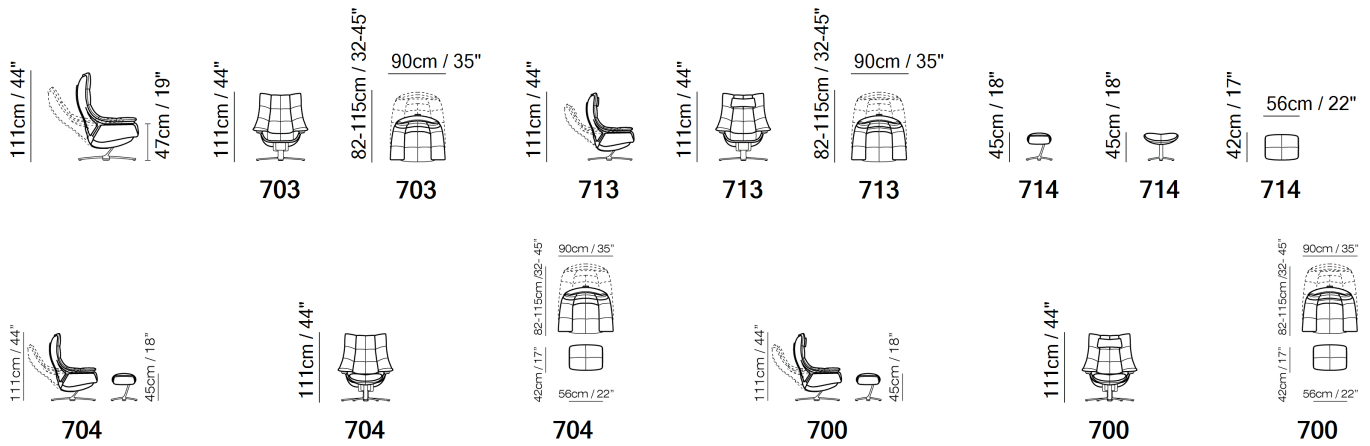

■ Vers. 700

SCHEMATICS



TECHNICAL INFORMATION

	COVERING	Leather <input checked="" type="checkbox"/>	Soft Cover <input checked="" type="checkbox"/>				
	FILLING	Arms	<input type="checkbox"/> Fiber <input checked="" type="checkbox"/> Foam <input type="checkbox"/> Feather/Fiber Mix <input type="checkbox"/> Feather	Seat cushion	<input type="checkbox"/> Fiber <input checked="" type="checkbox"/> Foam <input type="checkbox"/> Feather/Fiber Mix <input type="checkbox"/> Feather	Back cushion	<input type="checkbox"/> Fiber <input checked="" type="checkbox"/> Foam <input type="checkbox"/> Feather/Fiber Mix <input type="checkbox"/> Feather
	COMFORT	Standard Comfort <input checked="" type="checkbox"/>	Firm Comfort <input type="checkbox"/>				
	FUNCTION	Bed <input type="checkbox"/>	Electric motion <input type="checkbox"/>	Motion <input type="checkbox"/>	Recliner <input checked="" type="checkbox"/>	Sliding <input type="checkbox"/>	
	LEGS	Wood <input type="checkbox"/>	Metal <input checked="" type="checkbox"/>	Plastic <input type="checkbox"/>	Castors <input type="checkbox"/>	Upholstered <input type="checkbox"/>	

NOTES

- Available in TWO-TONE: welt to be entered as second covering. Both covers need to be in the same price category.
- Structure and base available in finishings matte black (BF01), white (BF02) or brown (BF03).

NOTES



■ Vers. 713



■ Vers. 713





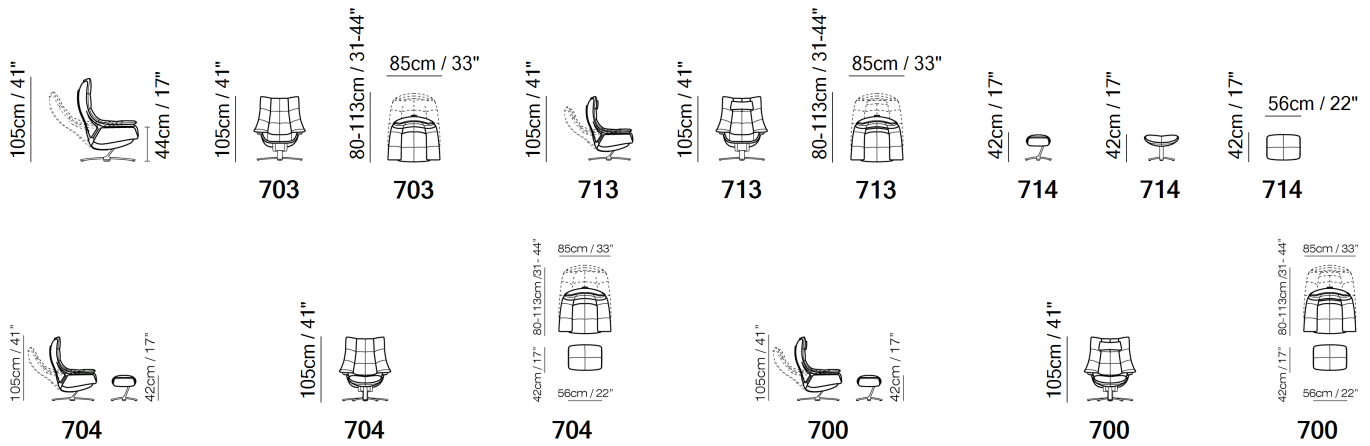

■ Vers. 700

SCHEMATICS



TECHNICAL INFORMATION

	COVERING	Leather <input checked="" type="checkbox"/>	Soft Cover <input checked="" type="checkbox"/>				
	FILLING	Arms	<input type="checkbox"/> Fiber <input checked="" type="checkbox"/> Foam <input type="checkbox"/> Feather/Fiber Mix <input type="checkbox"/> Feather	Seat cushion	<input type="checkbox"/> Fiber <input checked="" type="checkbox"/> Foam <input type="checkbox"/> Feather/Fiber Mix <input type="checkbox"/> Feather	Back cushion	<input type="checkbox"/> Fiber <input checked="" type="checkbox"/> Foam <input type="checkbox"/> Feather/Fiber Mix <input type="checkbox"/> Feather
	COMFORT	Firm Comfort <input type="checkbox"/>	Standard Comfort <input checked="" type="checkbox"/>				
	FUNCTION	Bed <input type="checkbox"/>	Electric motion <input type="checkbox"/>	Motion <input type="checkbox"/>	Recliner <input checked="" type="checkbox"/>	Sliding <input type="checkbox"/>	
	LEGS	Wood <input type="checkbox"/>	Upholstered <input type="checkbox"/>	Castors <input type="checkbox"/>	Plastic <input type="checkbox"/>	Metal <input checked="" type="checkbox"/>	

NOTES

- Available in TWO-TONE: welt to be entered as second covering. Both covers need to be in the same price category.
- Structure and base available in finishings matte black (BF01), white (BF02) or brown (BF03).

NATUZZI ITALIA

Re-Vive Quilted Queen 600Q

NOTES



■ Vers. 703



■ Vers. 703





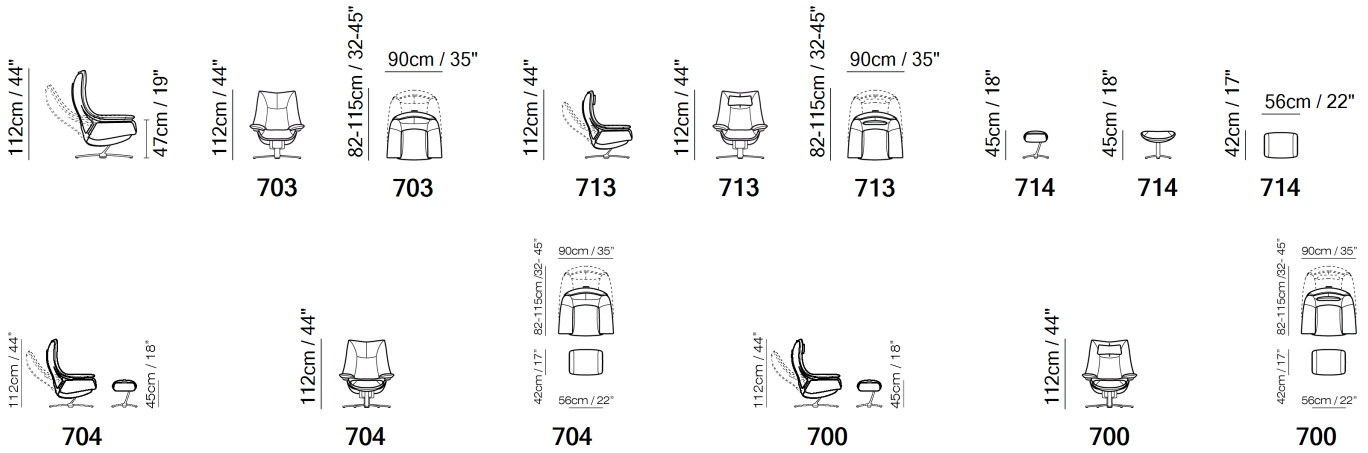

■ Vers. 704

SCHEMATICS



TECHNICAL INFORMATION

	COVERING	Leather <input checked="" type="checkbox"/>	Soft Cover <input checked="" type="checkbox"/>				
	FILLING	Arms	<input type="checkbox"/> Fiber <input checked="" type="checkbox"/> Foam <input type="checkbox"/> Feather/Fiber Mix <input type="checkbox"/> Feather	Seat cushion	<input type="checkbox"/> Fiber <input checked="" type="checkbox"/> Foam <input type="checkbox"/> Feather/Fiber Mix <input type="checkbox"/> Feather	Back cushion	<input type="checkbox"/> Fiber <input checked="" type="checkbox"/> Foam <input type="checkbox"/> Feather/Fiber Mix <input type="checkbox"/> Feather
	COMFORT	Firm Comfort <input type="checkbox"/>	Standard Comfort <input checked="" type="checkbox"/>				
	FUNCTION	Bed <input type="checkbox"/>	Electric motion <input type="checkbox"/>	Motion <input type="checkbox"/>	Recliner <input checked="" type="checkbox"/>	Sliding <input type="checkbox"/>	
	LEGS	Wood <input type="checkbox"/>	Metal <input checked="" type="checkbox"/>	Plastic <input type="checkbox"/>	Castors <input type="checkbox"/>	Upholstered <input type="checkbox"/>	

NOTES

- Structure and base available in finishings matte black (BF01), white (BF02) or brown (BF03).
- TWO TONE COVERING OPTIONS:
- 1° COV. = Frame
- 2° COV. = Arms, seat and back cushion

NOTES



■ Vers. 703



■ Vers. 703





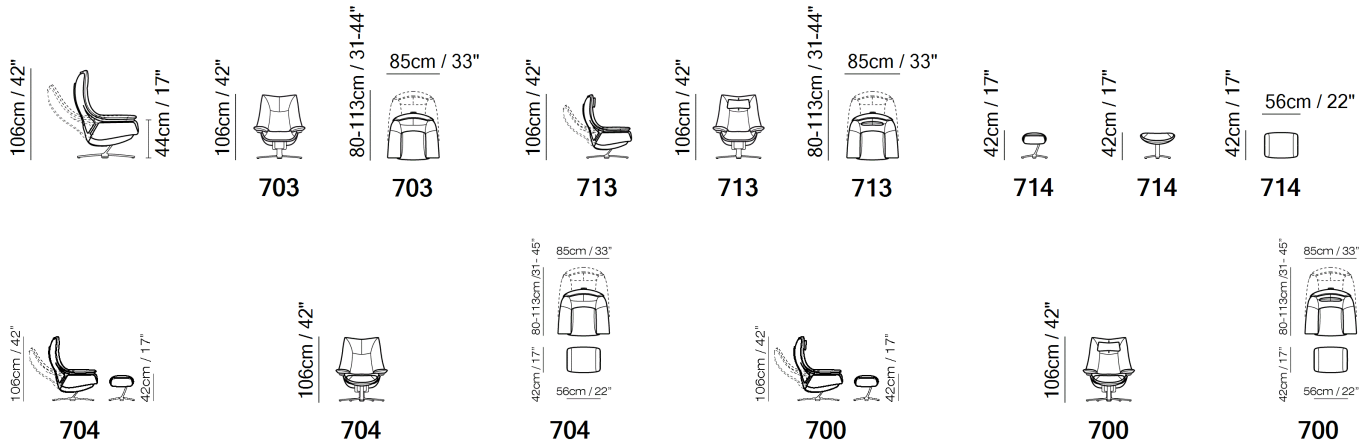

■ Vers. 704

SCHEMATICS



TECHNICAL INFORMATION

	COVERING	Leather <input checked="" type="checkbox"/>	Soft Cover <input checked="" type="checkbox"/>			
	FILLING	Arms <input type="checkbox"/> Fiber <input checked="" type="checkbox"/> Foam <input type="checkbox"/> Feather/Fiber Mix <input type="checkbox"/> Feather	Seat cushion <input type="checkbox"/> Fiber <input checked="" type="checkbox"/> Foam <input type="checkbox"/> Feather/Fiber Mix <input type="checkbox"/> Feather	Back cushion <input type="checkbox"/> Fiber <input checked="" type="checkbox"/> Foam <input type="checkbox"/> Feather/Fiber Mix <input type="checkbox"/> Feather		
	COMFORT	Firm Comfort <input type="checkbox"/>	Standard Comfort <input checked="" type="checkbox"/>			
	FUNCTION	Bed <input type="checkbox"/>	Electric motion <input type="checkbox"/>	Motion <input type="checkbox"/>	Recliner <input checked="" type="checkbox"/>	Sliding <input type="checkbox"/>
	LEGS	Wood <input type="checkbox"/>	Upholstered <input type="checkbox"/>	Castors <input type="checkbox"/>	Plastic <input type="checkbox"/>	Metal <input checked="" type="checkbox"/>

NOTES

- Structure and base available in finishings matte black (BF01), white (BF02) or brown (BF03).
- TWO TONE COVERING OPTIONS:
- 1° COV. = Frame
- 2° COV. = Arms, seat and back cushions

NOTES



■ Vers. 703



■ Vers. 703





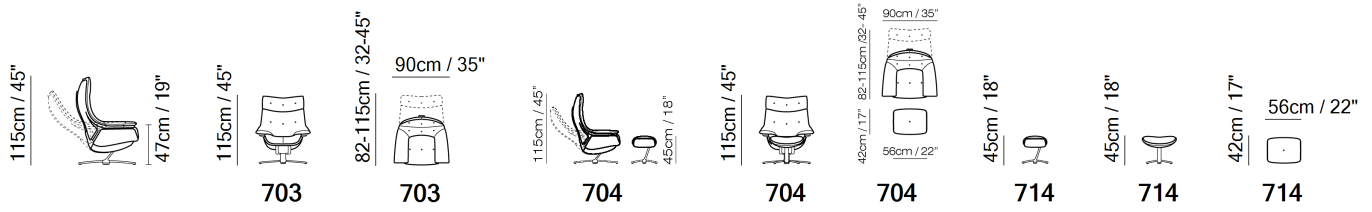

■ Vers. 704

SCHEMATICS



TECHNICAL INFORMATION

	COVERING	Leather <input checked="" type="checkbox"/>	Soft Cover <input checked="" type="checkbox"/>				
	FILLING	Arms	<input type="checkbox"/> Fiber <input checked="" type="checkbox"/> Foam <input type="checkbox"/> Feather/Fiber Mix <input type="checkbox"/> Feather	Seat cushion	<input type="checkbox"/> Fiber <input checked="" type="checkbox"/> Foam <input type="checkbox"/> Feather/Fiber Mix <input type="checkbox"/> Feather	Back cushion	<input type="checkbox"/> Fiber <input checked="" type="checkbox"/> Foam <input type="checkbox"/> Feather/Fiber Mix <input type="checkbox"/> Feather
	COMFORT	Firm Comfort <input type="checkbox"/>	Standard Comfort <input checked="" type="checkbox"/>				
	FUNCTION	Bed <input type="checkbox"/>	Electric motion <input type="checkbox"/>	Motion <input type="checkbox"/>	Recliner <input checked="" type="checkbox"/>	Sliding <input type="checkbox"/>	
	LEGS	Wood <input type="checkbox"/>	Metal <input checked="" type="checkbox"/>	Plastic <input type="checkbox"/>	Castors <input type="checkbox"/>	Upholstered <input type="checkbox"/>	

NOTES

- Model also available with thick leather with model code Sxxx (Art. Cassidy cat.60, Misterbianco cat.30).
- Structure and base available in finishings matte black (BF01), white (BF02) or brown (BF03).

NOTES



■ Vers. 703



■ Vers. 704



■ Vers. 703





FABRIC COVER DETAIL

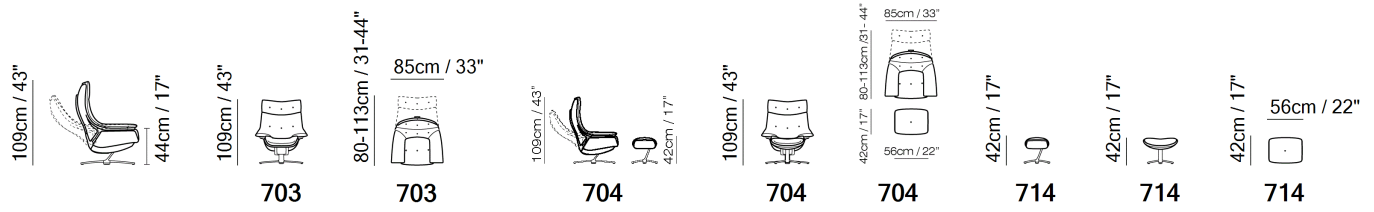

SCHEMATICS



TECHNICAL INFORMATION

	COVERING	Leather <input checked="" type="checkbox"/>	Soft Cover <input checked="" type="checkbox"/>			
	FILLING	Arms <input type="checkbox"/> Fiber <input checked="" type="checkbox"/> Foam <input type="checkbox"/> Feather/Fiber Mix <input type="checkbox"/> Feather	Seat cushion <input type="checkbox"/> Fiber <input checked="" type="checkbox"/> Foam <input type="checkbox"/> Feather/Fiber Mix <input type="checkbox"/> Feather	Back cushion <input type="checkbox"/> Fiber <input checked="" type="checkbox"/> Foam <input type="checkbox"/> Feather/Fiber Mix <input type="checkbox"/> Feather		
	COMFORT	Firm Comfort <input type="checkbox"/>	Standard Comfort <input checked="" type="checkbox"/>			
	FUNCTION	Bed <input type="checkbox"/>	Electric motion <input type="checkbox"/>	Motion <input type="checkbox"/>	Recliner <input checked="" type="checkbox"/>	Sliding <input type="checkbox"/>
	LEGS	Wood <input type="checkbox"/>	Upholstered <input type="checkbox"/>	Castors <input type="checkbox"/>	Plastic <input type="checkbox"/>	Metal <input checked="" type="checkbox"/>

NOTES

- Model also available with thick leather with model code Sxxx (Art. Cassidy cat.60, Misterbianco cat.30).
- Structure and base available in finishings matte black (BF01), white (BF02) or brown (BF03).

NOTES



■ Vers. 713



■ Vers. 713





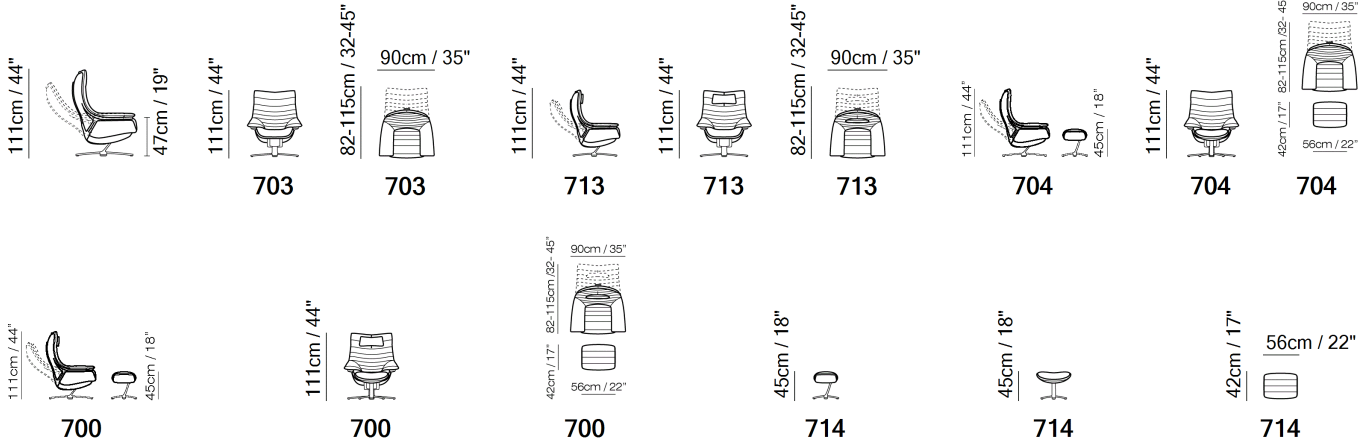

■ Vers. 700

SCHEMATICS



TECHNICAL INFORMATION

	COVERING	Leather <input checked="" type="checkbox"/>	Soft Cover <input checked="" type="checkbox"/>				
	FILLING	Arms	<input type="checkbox"/> Fiber <input checked="" type="checkbox"/> Foam <input type="checkbox"/> Feather/Fiber Mix <input type="checkbox"/> Feather	Seat cushion	<input type="checkbox"/> Fiber <input checked="" type="checkbox"/> Foam <input type="checkbox"/> Feather/Fiber Mix <input type="checkbox"/> Feather	Back cushion	<input type="checkbox"/> Fiber <input checked="" type="checkbox"/> Foam <input type="checkbox"/> Feather/Fiber Mix <input type="checkbox"/> Feather
	COMFORT	Firm Comfort <input type="checkbox"/>	Standard Comfort <input checked="" type="checkbox"/>				
	FUNCTION	Bed <input type="checkbox"/>	Electric motion <input type="checkbox"/>	Motion <input type="checkbox"/>	Recliner <input checked="" type="checkbox"/>	Sliding <input type="checkbox"/>	
	LEGS	Wood <input type="checkbox"/>	Metal <input checked="" type="checkbox"/>	Plastic <input type="checkbox"/>	Castors <input type="checkbox"/>	Upholstered <input type="checkbox"/>	

NOTES

- Model also available with thick leather with model code Sxxx (Art. Cassidy cat.60, Misterbianco cat.30).
- Structure and base available in finishings matte black (BF01), white (BF02) or brown (BF03).

NOTES



■ Vers. 703



■ Vers. 703





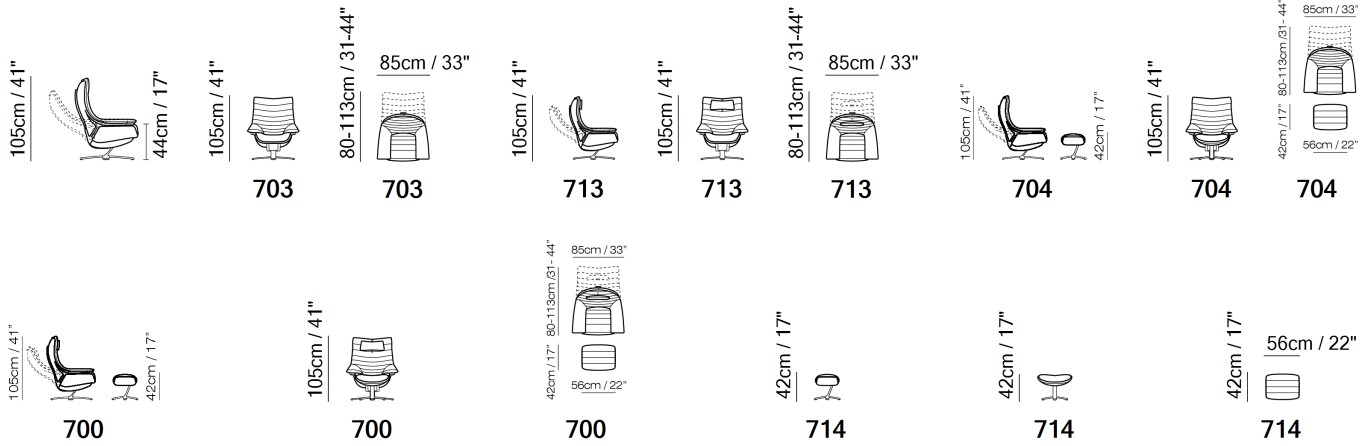

■ Vers. 704

SCHEMATICS



NATUZZI ITALIA Re-Vive Lounge Queen 605Q

TECHNICAL INFORMATION

	COVERING	Leather <input checked="" type="checkbox"/>	Soft Cover <input checked="" type="checkbox"/>				
	FILLING	Arms	<input type="checkbox"/> Fiber <input checked="" type="checkbox"/> Foam <input type="checkbox"/> Feather/Fiber Mix <input type="checkbox"/> Feather	Seat cushion	<input type="checkbox"/> Fiber <input checked="" type="checkbox"/> Foam <input type="checkbox"/> Feather/Fiber Mix <input type="checkbox"/> Feather	Back cushion	<input type="checkbox"/> Fiber <input checked="" type="checkbox"/> Foam <input type="checkbox"/> Feather/Fiber Mix <input type="checkbox"/> Feather
	COMFORT	Firm Comfort <input type="checkbox"/>	Standard Comfort <input checked="" type="checkbox"/>				
	FUNCTION	Bed <input type="checkbox"/>	Electric motion <input type="checkbox"/>	Motion <input type="checkbox"/>	Recliner <input checked="" type="checkbox"/>	Sliding <input type="checkbox"/>	
	LEGS	Wood <input type="checkbox"/>	Upholstered <input type="checkbox"/>	Castors <input type="checkbox"/>	Plastic <input type="checkbox"/>	Metal <input checked="" type="checkbox"/>	

NOTES

- Model also available with thick leather with model code Sxxx (Art. Cassidy cat.60, Misterbianco cat.30).
- Structure and base available in finishings matte black (BF01), white (BF02) or brown (BF03).

NATUZZI ITALIA Re-Vive Lounge Queen 605Q

NOTES

NATUZZI ITALIA Re-Vive Wing Back King 608K



■ Vers. 703



■ Vers. 703



■ Vers. 704



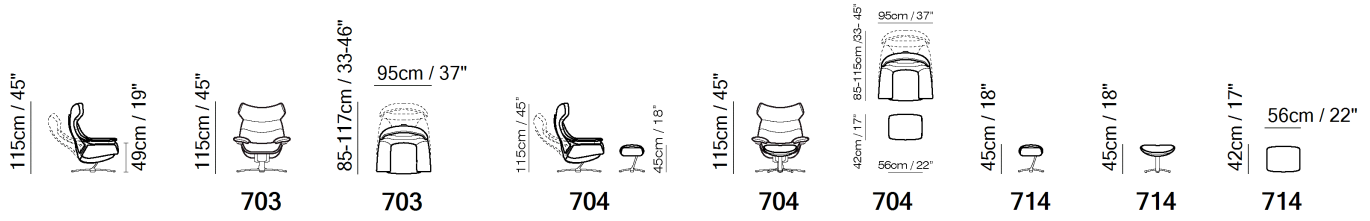

NATUZZI ITALIA Re-Vive Wing Back King 608K

SCHEMATICS



NATUZZI ITALIA Re-Vive Wing Back King 608K

TECHNICAL INFORMATION

	COVERING	Leather <input checked="" type="checkbox"/>	Soft Cover <input checked="" type="checkbox"/>				
	FILLING	Arms	<input type="checkbox"/> Fiber <input checked="" type="checkbox"/> Foam <input type="checkbox"/> Feather/Fiber Mix <input type="checkbox"/> Feather	Seat cushion	<input type="checkbox"/> Fiber <input checked="" type="checkbox"/> Foam <input type="checkbox"/> Feather/Fiber Mix <input type="checkbox"/> Feather	Back cushion	<input type="checkbox"/> Fiber <input checked="" type="checkbox"/> Foam <input type="checkbox"/> Feather/Fiber Mix <input type="checkbox"/> Feather
	COMFORT	Firm Comfort <input type="checkbox"/>	Standard Comfort <input checked="" type="checkbox"/>				
	FUNCTION	Bed <input type="checkbox"/>	Electric motion <input type="checkbox"/>	Motion <input type="checkbox"/>	Recliner <input checked="" type="checkbox"/>	Sliding <input type="checkbox"/>	
	LEGS	Wood <input type="checkbox"/>	Metal <input checked="" type="checkbox"/>	Plastic <input type="checkbox"/>	Castors <input type="checkbox"/>	Upholstered <input type="checkbox"/>	

NOTES

- The Re-vive Wing Back armchair has characteristic warmly embracing shape.
- Equipped with a wide and welcoming backrest, Wing Back offers incomparable comfort, crowned by a singular headrest that resembles wings, welcoming those who sit down and allowing them to enjoy a moment of unparalleled relaxation.
- The Wing Back armchair combines Natuzzi comfort and the most modern ergonomics.
- Version 704 is composed of chair and footrest.
- Structure and base available in finishings matte black (BF01), white (BF02) or brown (BF03).
- TWO TONE COVERING OPTIONS:
- 1° COV. = Frame
- 2° COV. = Arms, seat and back cushion

NATUZZI ITALIA Re-Vive Wing Back King 608K

NOTES



■ Vers. 703



■ Vers. 703





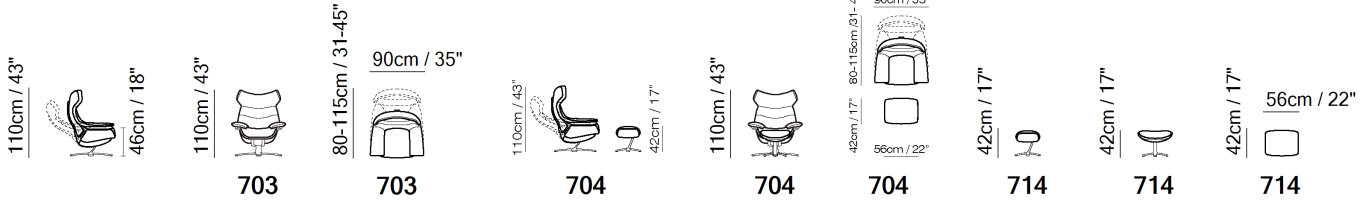

■ Vers. 704

SCHEMATICS



TECHNICAL INFORMATION

	COVERING	Leather <input checked="" type="checkbox"/>	Soft Cover <input checked="" type="checkbox"/>			
	FILLING	Arms <input type="checkbox"/> Fiber <input checked="" type="checkbox"/> Foam <input type="checkbox"/> Feather/Fiber Mix <input type="checkbox"/> Feather	Seat cushion <input type="checkbox"/> Fiber <input checked="" type="checkbox"/> Foam <input type="checkbox"/> Feather/Fiber Mix <input type="checkbox"/> Feather	Back cushion <input type="checkbox"/> Fiber <input checked="" type="checkbox"/> Foam <input type="checkbox"/> Feather/Fiber Mix <input type="checkbox"/> Feather		
	COMFORT	Firm Comfort <input type="checkbox"/>	Standard Comfort <input checked="" type="checkbox"/>			
	FUNCTION	Bed <input type="checkbox"/>	Electric motion <input type="checkbox"/>	Motion <input type="checkbox"/>	Recliner <input checked="" type="checkbox"/>	Sliding <input type="checkbox"/>
	LEGS	Wood <input type="checkbox"/>	Upholstered <input type="checkbox"/>	Castors <input type="checkbox"/>	Plastic <input type="checkbox"/>	Metal <input checked="" type="checkbox"/>

NOTES

- The Re-vive Wing Back armchair has characteristic warmly embracing shape.
- Equipped with a wide and welcoming backrest, Wing Back offers incomparable comfort, crowned by a singular headrest that resembles wings, welcoming those who sit down and allowing them to enjoy a moment of unparalleled relaxation.
- The Wing Back armchair combines Natuzzi comfort and the most modern ergonomics.
- Version 704 is composed of chair and footrest.
- Structure and base available in finishings matte black (BF01), white (BF02) or brown (BF03).
- TWO TONE COVERING OPTIONS:
- 1° COV. = Frame
- 2° COV. = Arms, seat and back cushion

NOTES



■ Vers. 703



■ Vers. 703



■ Vers. 704

SCHEMATICS

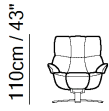

703

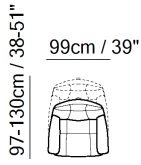

703



704



704

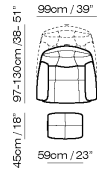

704

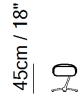

714





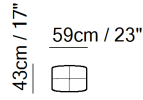

714



714

TECHNICAL INFORMATION

	COVERING	Leather <input checked="" type="checkbox"/>	Soft Cover <input checked="" type="checkbox"/>				
	FILLING	Arms	<input type="checkbox"/> Fiber <input checked="" type="checkbox"/> Foam <input type="checkbox"/> Feather/Fiber Mix <input type="checkbox"/> Feather	Seat cushion	<input type="checkbox"/> Fiber <input checked="" type="checkbox"/> Foam <input type="checkbox"/> Feather/Fiber Mix <input type="checkbox"/> Feather	Back cushion	<input type="checkbox"/> Fiber <input checked="" type="checkbox"/> Foam <input type="checkbox"/> Feather/Fiber Mix <input type="checkbox"/> Feather
	COMFORT	Firm Comfort <input type="checkbox"/>	Standard Comfort <input checked="" type="checkbox"/>				
	FUNCTION	Bed <input type="checkbox"/>	Electric motion <input type="checkbox"/>	Motion <input type="checkbox"/>	Recliner <input checked="" type="checkbox"/>	Sliding <input type="checkbox"/>	
	LEGS	Wood <input type="checkbox"/>	Metal <input checked="" type="checkbox"/>	Plastic <input type="checkbox"/>	Castors <input type="checkbox"/>	Upholstered <input type="checkbox"/>	

NOTES

- Re-Vive Myway gives you an immediate sense of comfort: a light soft quilted geometry ergonomically accompanies the seat support, wrapping the whole Re-Vive technology. A gesture of tapestry expression and tailoring prêt-à-porter to meet the contemporary living, for uninhibited and expressive demanding environments which are expression of strong personality
- Back spine and structure integrated in the padding (down jacket style) under the seat in order to have a different look and a more appealing design.
- The mix of high density polyurethane foam (density 35HM) and CLIMALIGHT, a special blend of last generation silicon microfibers, guarantees extraordinary comfort and unchanged look over time.
- Metal Base and Plastic Cup under seat cushion available in standard finishes: (BF01) black/black, (BF02) white/white, and (BF03) brown/brown

NOTES



■ Vers. 703



■ Vers. 703





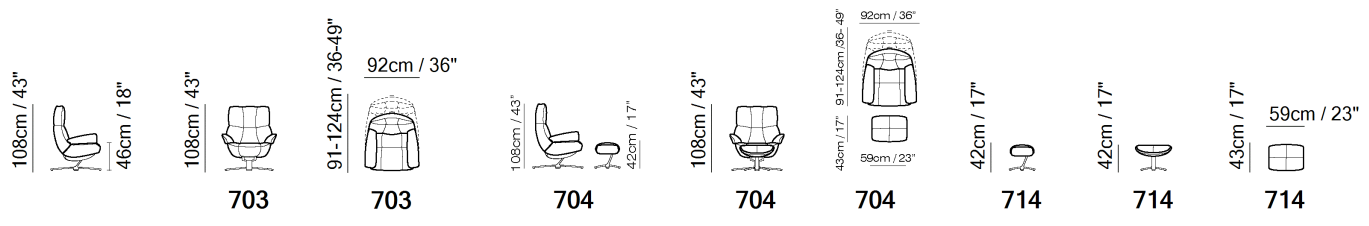

■ Vers. 704

SCHEMATICS



TECHNICAL INFORMATION

	COVERING	Leather <input checked="" type="checkbox"/>	Soft Cover <input checked="" type="checkbox"/>				
	FILLING	Arms	<input type="checkbox"/> Fiber <input checked="" type="checkbox"/> Foam <input type="checkbox"/> Feather/Fiber Mix <input type="checkbox"/> Feather	Seat cushion	<input type="checkbox"/> Fiber <input checked="" type="checkbox"/> Foam <input type="checkbox"/> Feather/Fiber Mix <input type="checkbox"/> Feather	Back cushion	<input type="checkbox"/> Fiber <input checked="" type="checkbox"/> Foam <input type="checkbox"/> Feather/Fiber Mix <input type="checkbox"/> Feather
	COMFORT	Firm Comfort <input type="checkbox"/>	Standard Comfort <input checked="" type="checkbox"/>				
	FUNCTION	Bed <input type="checkbox"/>	Electric motion <input type="checkbox"/>	Motion <input type="checkbox"/>	Recliner <input checked="" type="checkbox"/>	Sliding <input type="checkbox"/>	
	LEGS	Wood <input type="checkbox"/>	Upholstered <input type="checkbox"/>	Castors <input type="checkbox"/>	Plastic <input type="checkbox"/>	Metal <input checked="" type="checkbox"/>	

NOTES

- Re-Vive Myway gives you an immediate sense of comfort: a light soft quilted geometry ergonomically accompanies the seat support, wrapping the whole Re-Vive technology. A gesture of tapestry expression and tailoring prêt-à-porter to meet the contemporary living, for uninhibited and expressive demanding environments which are expression of strong personality
- Back spine and structure integrated in the padding (down jacket style) under the seat in order to have a different look and a more appealing design.
- The mix of high density polyurethane foam (density 35HM) and CLIMALIGHT, a special blend of last generation silicon microfibers, guarantees extraordinary comfort and unchanged look over time.
- Metal Base and Plastic Cup under seat cushion available in standard finishes: (BF01) black/black, (BF02) white/white, and (BF03) brown/brown

NOTES



■ Vers. 703



■ Vers. 703





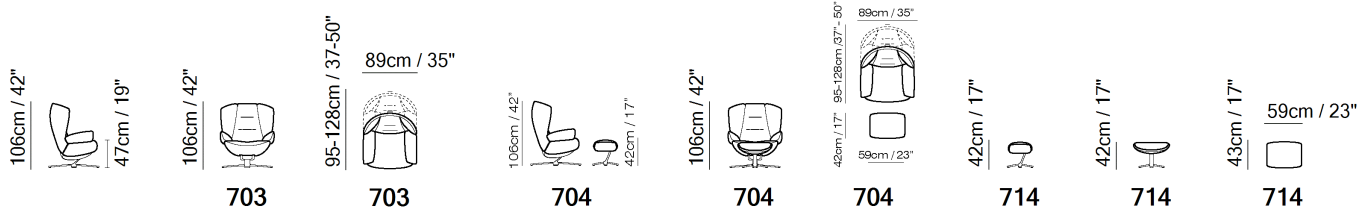

■ Vers. 704

SCHEMATICS



TECHNICAL INFORMATION

	COVERING	Leather <input checked="" type="checkbox"/>	Soft Cover <input checked="" type="checkbox"/>				
	FILLING	Arms	<input type="checkbox"/> Fiber <input checked="" type="checkbox"/> Foam <input type="checkbox"/> Feather/Fiber Mix <input type="checkbox"/> Feather	Seat cushion	<input type="checkbox"/> Fiber <input checked="" type="checkbox"/> Foam <input type="checkbox"/> Feather/Fiber Mix <input type="checkbox"/> Feather	Back cushion	<input type="checkbox"/> Fiber <input checked="" type="checkbox"/> Foam <input type="checkbox"/> Feather/Fiber Mix <input type="checkbox"/> Feather
	COMFORT	Firm Comfort <input type="checkbox"/>	Standard Comfort <input checked="" type="checkbox"/>				
	FUNCTION	Bed <input type="checkbox"/>	Electric motion <input type="checkbox"/>	Motion <input type="checkbox"/>	Recliner <input checked="" type="checkbox"/>	Sliding <input type="checkbox"/>	
	LEGS	Wood <input type="checkbox"/>	Metal <input checked="" type="checkbox"/>	Plastic <input type="checkbox"/>	Castors <input type="checkbox"/>	Upholstered <input type="checkbox"/>	

NOTES

- A contemporary application of fanciful classic bergère on Revive is a futuristic interpretation of comfort. This combination takes the standards of comfort to another level where it can be attuned ad personam.
- Back spine and structure integrated in the padding (down jacket style) under the seat in order to have a different look and a more appealing design.
- The mix of high density polyurethane foam (density 35HM) and CLIMALIGHT, a special blend of last generation silicon microfibers, guarantees extraordinary comfort and unchanged look over time.
- Model is available with welt in Gros-Grain (3 cm) to be entered as second covering (code 10800004xx)
- Metal Base and Plastic Cup under seat cushion available in standard finishes: (BF01) black/black, (BF02) white/white, and (BF03) brown/brown

NOTES



■ Vers. 703



■ Vers. 704





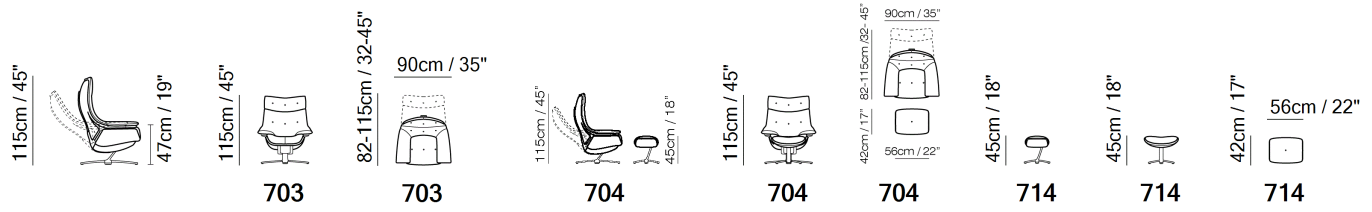

■ Vers. 703

SCHEMATICS



TECHNICAL INFORMATION

	COVERING	Leather <input checked="" type="checkbox"/>									
	FILLING	Arms	<input type="checkbox"/> Fiber <input checked="" type="checkbox"/> Foam <input type="checkbox"/> Feather/Fiber Mix <input type="checkbox"/> Feather	Seat cushion	<input type="checkbox"/> Fiber <input checked="" type="checkbox"/> Foam <input type="checkbox"/> Feather/Fiber Mix <input type="checkbox"/> Feather	Back cushion	<input type="checkbox"/> Fiber <input checked="" type="checkbox"/> Foam <input type="checkbox"/> Feather/Fiber Mix <input type="checkbox"/> Feather				
	COMFORT	Firm Comfort	<input type="checkbox"/>	Standard Comfort	<input checked="" type="checkbox"/>						
	FUNCTION	Bed	<input type="checkbox"/>	Electric motion	<input type="checkbox"/>	Motion	<input type="checkbox"/>	Recliner	<input checked="" type="checkbox"/>	Sliding	<input type="checkbox"/>
	LEGS	Wood	<input type="checkbox"/>	Upholstered	<input type="checkbox"/>	Castors	<input type="checkbox"/>	Plastic	<input type="checkbox"/>	Metal	<input checked="" type="checkbox"/>

NOTES

- Model is available only with thick leather (Cassidy).
- Structure and base available in finishings matte black (BF01), white (BF02) or brown (BF03).

NOTES



■ Vers. 703



■ Vers. 703





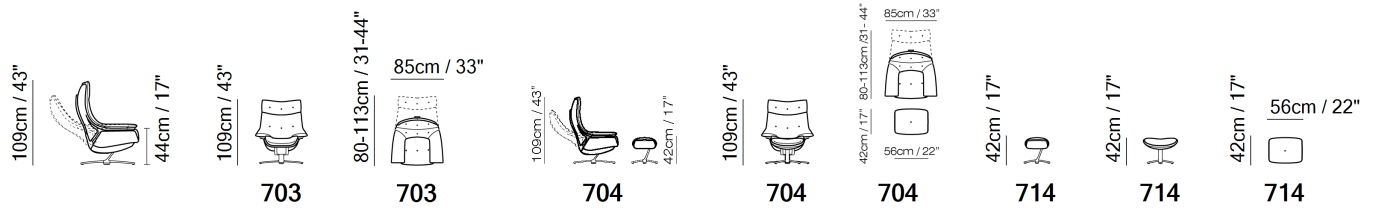

■ Vers. 704

SCHEMATICS



TECHNICAL INFORMATION

	COVERING	Leather <input checked="" type="checkbox"/>				
	FILLING	Arms <input type="checkbox"/> Fiber <input checked="" type="checkbox"/> Foam <input type="checkbox"/> Feather/Fiber Mix <input type="checkbox"/> Feather	Seat cushion <input type="checkbox"/> Fiber <input checked="" type="checkbox"/> Foam <input type="checkbox"/> Feather/Fiber Mix <input type="checkbox"/> Feather	Back cushion <input type="checkbox"/> Fiber <input checked="" type="checkbox"/> Foam <input type="checkbox"/> Feather/Fiber Mix <input type="checkbox"/> Feather		
	COMFORT	Standard Comfort <input checked="" type="checkbox"/>	Firm Comfort <input type="checkbox"/>			
	FUNCTION	Bed <input type="checkbox"/>	Electric motion <input type="checkbox"/>	Motion <input type="checkbox"/>	Recliner <input checked="" type="checkbox"/>	Sliding <input type="checkbox"/>
	LEGS	Wood <input type="checkbox"/>	Metal <input checked="" type="checkbox"/>	Plastic <input type="checkbox"/>	Castors <input type="checkbox"/>	Upholstered <input type="checkbox"/>

NOTES

- Model is available only with thick leather (Cassidy).
- Structure and base available in finishings matte black (BF01), white (BF02) or brown (BF03).

NOTES
