



TIMELESS
OUTDOORS
2026

EXPORT RETAIL PRICE LIST 2026 EXW



EXPORT RETAIL PRICE LIST EXW
2026

TIMELESS
OUTDOORS



contents

4	PRICE LIST READING / LETTURA DEL LISTINO
6	SALES TERMS AND CONDITIONS / CONDIZIONI GENERALI DI VENDITA

COLLECTIONS (A-Z)

8	ALICE	88	MOGAN
16	ARIA	90	NÉA_NEW
18	BISTROT	94	NINA_NEW
20	BUNDI_NEW	95	PARK
24	CIAO	96	QUATRIS
26	DAISY	104	ROMA
36	DAISY ROPE	110	SEASIDE
46	EMMA	114	SLOT
47	EXTIA	118	SPRINGTIME
48	FELLINI	122	STEP
49	FIRENZE_NEW	124	TOSCA
50	FLORA	128	TWIST
52	FOX	136	VALENTINO SUMMERTIME
58	HAMPTONS	140	VEGAS
66	HUG	142	VERA_NEW
68	KEY WEST	146	VERDEA
76	MIAMI	152	VERDEA ROPE
84	MIMMO RONDO'	162	VERSTONE_NEW
156	ABRI_NEW		
162	TABLETOPS / PIANI TAVOLO_NEW		
172	TABLETOPS AND BASES_NEW		
174	PILLOW / CUSCINI		
178	LIGHTING / ILLUMINAZIONE		
181	CARPETS / TAPPETI		
184	COVER		

Price list reading / Lettura del listino

Collection / Collezione

Designer

Collection components
Componenti della collezione

Daisy Rope
Designed by Vermobil Team

Available finishings / Finiture disponibili

frame / struttura
materiali: alluminio, acciaio, legno

fabrics / tessuti
tessuti: P102, S102, T101, M101, S101, A101, P101, C101, P101, S101, L101, C101, F101, W101

rope / corda
TA 101, AL 101, PA 101

Pillow / Cuscini Jolly

More information on colors and fabrics on page 184 / Più informazioni colori e tessuti da pagina 184

Manufacturer's suggested retail price, VAT not included / Prezzo consigliato di vendita al pubblico, IVA esclusa

Items equipped with a cord are marked with the letter "X" at the end of the code. After selecting the cord, this letter will be replaced by the number identifying its colour. Gli articoli dotati di corda sono contraddistinti dalla lettera "X" alla fine del codice. Tale lettera, in seguito alla scelta della corda, sarà sostituita dal numero che identifica il colore della stessa.

SKU / Codice articolo

Item description / Descrizione articolo

Frame + cushion set total price
Prezzo totale struttura + set cuscini

Product data
Specifiche del prodotto

Packaging data
Informazioni di imballo

Item weight / Peso articolo

Frame colour
Colore struttura

Quick ship
Pronta consegna

Item dimensions
Dimensioni articolo

Fabric Category / Categoria Tessuto

Daisy Rope

DE60XI Lounge chair / Poltrona bassa

TOTAL PRICE WITH BUSINESS CUSHIONS / PREZZO TOTALE CON CUSCINI BUSINESS € 1.255
 TOTAL PRICE WITH SUNSET CUSHIONS / PREZZO TOTALE CON CUSCINI SUNSET € 1.322
 TOTAL PRICE WITH AVANT-GARDE CUSHIONS / PREZZO TOTALE CON CUSCINI AVANT-GARDE € 1.322

Stainless steel AISI 316 L / Acciaio inossidabile AISI 316 L
 Seat and back cushion included / Cuscino seduta e schienale inclusi
 Removable Cushions / Cuscini sfoderabili

Washable / Lavabile
 Waterproof gel-backing / Federa impermeabile
 Weight / Peso : 14 Kg

packaging / imballo 1 048 17 14 183 776 177

CODE / CODICE	FRAME / STRUTTURA	WPS / CORSA	ES / FC	PRICE / €
DE60LAB	ancient grey / grigio antico	large / large	X	€ 1.192
DE60LAD	ancient grey / grigio antico	large / large		€ 1.192
DE60LAL	ancient grey / grigio antico	medium / medio		€ 1.192
DE60LAF	medium / medio	medium / medio		€ 1.192
DE60LFB	medium / medio	medium / medio	X	€ 1.192
DE60LFS	medium / medio	medium / medio		€ 1.192

Cushion fabric set / Tessuti set cuscineria: 1 seat cushion + 1 back cushion / 1 cuscino seduta + 1 cuscino schienale

CODE / CODICE	BUSINESS	ES / FC	PRICE	CODE / CODICE	SUNSET	ES / FC	PRICE	CODE / CODICE	AVANT-GARDE	ES / FC	PRICE
DE60KIT.FBI	brush	X	€ 243	DE60KIT.FBS	brush		€ 201	DE60KIT.CDS	cream star		€ 201
DE60KIT.ECS	ecru		€ 243	DE60KIT.CPS	orange		€ 201	DE60KIT.FDS	medium grey star		€ 201
DE60KIT.FPS	taupe		€ 243	DE60KIT.PDS	paragon		€ 201	DE60KIT.WDS	white star		€ 201
DE60KIT.BDS	brisa		€ 243	DE60KIT.LDS	ice		€ 201				
DE60KIT.GDS	grey	X	€ 243	DE60KIT.LMS	honeydew		€ 201				
DE60KIT.ADS	anthracite		€ 243								

CATAS is the certifying entity according to the technical standards of the sector. The tests are carried on in compliance with European (EN) and international (ISO) standards. The products bearing this logo have undergone testing and obtained the CATAS certification.

CATAS è l'ente che si occupa della certificazione dei prodotti secondo le norme tecniche del settore. Le prove sono condotte in conformità alle norme europee (EN) e internazionali (ISO). I prodotti che riportano questo logo sono testati e hanno conseguito la certificazione CATAS.

Export sales conditions / Condizioni generali di vendita

Placing an order with Vermobil implies accepting our sales conditions.

Prices

- Prices are suggested retail prices, excluding VAT, and are valid for all orders from October 1st, 2025 to August 31st 2026.
- We reserve the right to modify the present price list during the season.
- This price list supersedes all previous versions and is valid, unless otherwise notified, until August 31st, 2026.

Customization

- Upon request, our products can be finished with any RAL colour reference. Please contact us for MOQ and prices.

Orders & deliveries

- Detailed information about our delivery service and/or transport costs will be provided on our order confirmation.
- All orders should be confirmed in writing by the purchaser using Vermobil's order form if possible.
- You will receive an order confirmation within 72 hours. Please check it thoroughly. The goods will be delivered to you as described on the order confirmation.
- Special delivery conditions (delivery on appointment, by van, special packaging, etc.) must be mentioned when placing the order and confirmed by Vermobil as they can cause additional charges.

Maintenance

- Please have a look at our care guide in our catalogue or in our website www.vermobil.it for detailed maintenance instructions of our products.

Guarantees

Domestic & Contract usage:

- All Vermobil products have a 2-year guarantee against manufacturing defaults.

Exceptions for guarantee:

- Any damage arising from insufficient care, from non-compliance with the supplied instructions and advice for maintenance and storage.
- Natural aging/fading.
- Any modifications made to the product voids the guarantee.

All of our products are manufactured, quality controlled and packed with care, however, if you should notice that the received goods do not fulfil the standard quality, please bear these guidelines in mind:

- Transport damage: needs to be written immediately at delivery and in detail on the CMR document. Complaints on transport damage will not be accepted if they are not mentioned on the CMR document.
- Product defects: must be communicated in writing within 15 days after reception of the goods along with pictures of the defect. After this period, complaints will no longer be accepted.
- Unless otherwise agreed in writing, all pallets not returned to Vermobil will be invoiced.
- Quantities ordered must correspond to the packaging unit for each item.



Alice

Designed by Vermobil Team



frame / struttura

standard colours / colori standard



AG BRO FA BS ME TC CO BCU

fabrics / tessuti

business

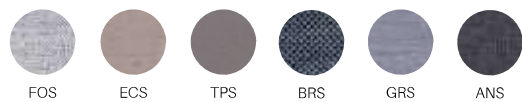

FOS ECS TPS BRS GRS ANS

back and seat batyline / batyline seduta e schienale

basic

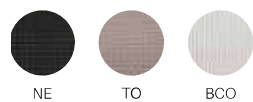

NE TO BCO



Pillow Pag. 174



More information on colors and fabrics from page 194 / Più informazioni su colori e tessuti da pagina 194

Manufacturer's suggested retail price, VAT not included / Prezzo consigliato di vendita al pubblico, IVA esclusa.

CH1555 Chair / Sedia

Galvanized steel / Acciaio zincato
Stackable / Impilabile (8 pcs)

CATAS
Weight / Peso : 4,6 Kg

packaging / imballo  8  0,38  43 CM L 109 P 69 H 50

Frame / Struttura

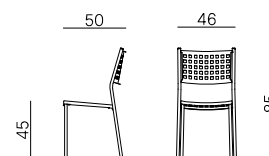

CODE / CODICE	FRAME / STRUTTURA	Q.S / P.C	PRICE / €
CH1555.AG	ancient grey / grigio antico	•	€ 100
CH1555.BRO	bronze / bronzo	•	€ 100
CH1555.FA	mud grey / fango	•	€ 100
CH1555.BS	ivory white / bianco perla	•	€ 100
CH1555.ME	mint green / menta		€ 100
CH1555.TC	terracotta / terracotta		€ 100
CH1555.CO	corten / corten		€ 100
CH1555.BCU	matt white / bianco goffrato		€ 100



CH1550 Armchair / Poltrona

Galvanized steel / Acciaio zincato
Stackable / Impilabile (8 pcs)

CATAS
Weight / Peso : 5,2 Kg

packaging / imballo  8  0,46  45 CM L 110 P 73 H 57

Frame / Struttura

CODE / CODICE	FRAME / STRUTTURA	Q.S / P.C	PRICE / €
CH1550.AG	ancient grey / grigio antico	•	€ 107
CH1550.BRO	bronze / bronzo	•	€ 107
CH1550.FA	mud grey / fango	•	€ 107
CH1550.BS	ivory white / bianco perla	•	€ 107
CH1550.ME	mint green / menta		€ 107
CH1550.TC	terracotta / terracotta		€ 107
CH1550.CO	corten / corten		€ 107
CH1550.BCU	matt white / bianco goffrato		€ 107

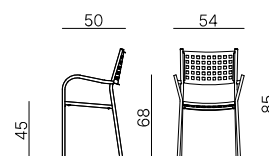



Alice

CH150 Barstool / Sgabello

Galvanized steel / Acciaio zincato
Stackable / Impilabile (8 pcs)

Weight / Peso : 7,2 Kg

packaging / imballo  1  0,3  9,6 CM L 116 P 54 H 49

Frame / Struttura

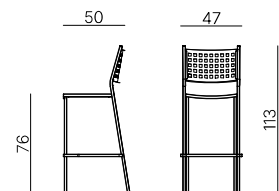

CODE / CODICE	FRAME / STRUTTURA	Q.S / P.C	PRICE / €
CH150.AG	ancient grey / grigio antico	•	€ 208
CH150.BRO	bronze / bronzo	•	€ 208
CH150.FA	mud grey / fango	•	€ 208
CH150.BS	ivory white / bianco perla	•	€ 208
CH150.ME	mint green / menta		€ 208
CH150.TC	terracotta / terracotta		€ 208
CH150.CO	corten / corten		€ 208
CH150.BCU	matt white / bianco goffrato		€ 208



CU113 Seat cushion / Cuscino seduta (for / per CH1555, CH1550, CH150)

Removable Cushion / Cuscino sfoderabile
Washable / Lavabile

Waterproof gel-backing / Fodera impermeabile
Weight / Peso : 0,4 Kg

packaging / imballo  1  0,01  0,6 CM L 44 P 44 H 6

Cushion fabric set / Tessuti set cuscineria

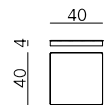

CODE / CODICE	BUSINESS	Q.S / P.C	PRICE
CU113.FOS	fossil	•	€ 57



CUSRM100 Seat cushion / Cuscino seduta (for / per CH1555, CH1550, CH150)

Non-removable / Non sfoderabile
Anti-slip / Antiscivolo
With magnet / Con calamita

Washable / Lavabile
Waterproof gel-backing / Fodera impermeabile
Weight / Peso : 0,2 Kg

packaging / imballo  1  0,01  0,4 CM L 42 P 40 H 3

Cushion fabric set / Tessuti set cuscineria

CODE / CODICE	BUSINESS	Q.S / P.C	PRICE
CUSRM100.FOS	fossil	•	€ 45
CUSRM100.ECS	ecru		€ 45
CUSRM100.TPS	taupe		€ 45
CUSRM100.BRS	brisa		€ 45
CUSRM100.GRS	grey		€ 45
CUSRM100.ANS	anthracite		€ 45

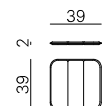



CH201 Coffee table / Tavolo basso

Galvanized steel / Acciaio zincato

Stackable / Impilabile (4 pcs)

Weight / Peso : 5,6 Kg

packaging / imballo  1  0,11  7 CM L 53 P 53 H 39

Frame / Struttura

CODE / CODICE	FRAME / STRUTTURA	Q.S / P.C	PRICE / €
CH201.AG	ancient grey / grigio antico	•	€ 169
CH201.BRO	bronze / bronzo		€ 169
CH201.FA	mud grey / fango		€ 169
CH201.BS	ivory white / bianco perla		€ 169
CH201.ME	mint green / menta		€ 169
CH201.TC	terracotta / terracotta		€ 169
CH201.CO	corten / corten		€ 169
CH201.BCU	matt white / bianco goffrato		€ 169

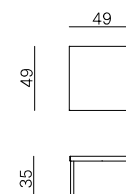



CH600 Lounge Chair / Poltrona bassa

Galvanized steel / Acciaio zincato

Stackable / Impilabile (4 pcs)

Weight / Peso : 7 Kg

packaging / imballo  2  0,39  20 CM L 69 P 67 H 84

Frame / Struttura

CODE / CODICE	FRAME / STRUTTURA	Q.S / P.C	PRICE / €
CH600.AG	ancient grey / grigio antico	•	€ 251
CH600.BRO	bronze / bronzo		€ 251
CH600.FA	mud grey / fango		€ 251
CH600.BS	ivory white / bianco perla		€ 251
CH600.ME	mint green / menta		€ 251
CH600.TC	terracotta / terracotta		€ 251
CH600.CO	corten / corten		€ 251
CH600.BCU	matt white / bianco goffrato		€ 251

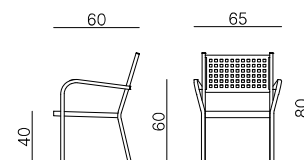



CUCH600 Seat Cushion / Cuscino seduta (for / per CH600)

Removable Cushion / Cuscino sfoderabile

Washable / Lavabile

Waterproof gel-backing / Fodera impermeabile

Weight / Peso : 0,7 Kg

packaging / imballo  1  0,02  1 CM L 51 P 51 H 6

Cushion fabric set / Tessuti set cuscineria

CODE / CODICE	BUSINESS	Q.S / P.C	PRICE
CUCH600.FOS	fossil	•	€ 80

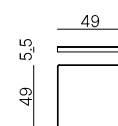

Alice

CH630 Sofa / Divano

Galvanized steel / Acciaio zincato

Stackable / Impilabile (4 pcs)

Weight / Peso : 13,5 Kg

packaging / imballo  1  0,66  18 CM L 126 P 64 H 82

Frame / Struttura

CODE / CODICE	FRAME / STRUTTURA	Q.S / P.C	PRICE / €
CH630.AG	ancient grey / grigio antico	•	€ 389
CH630.BRO	bronze / bronzo		€ 389
CH630.FA	mud grey / fango		€ 389
CH630.BS	ivory white / bianco perla		€ 389
CH630.ME	mint green / menta		€ 389
CH630.TC	terracotta / terracotta		€ 389
CH630.CO	corten / corten		€ 389
CH630.BCU	matt white / bianco gofrato		€ 389

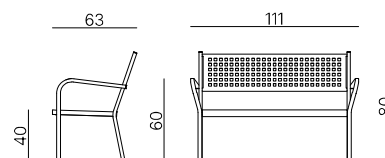



CUCH630 Seat Cushion / Cuscino seduta (for / per CH630)

Removable Cushion / Cuscino sfoderabile

Washable / Lavabile

Waterproof gel-backing / Fodera impermeabile

Weight / Peso : 2 Kg

packaging / imballo  1  0,05  3 CM L 151 P 51 H 6

Cushion fabric set / Tessuti set cuscineria

CODE / CODICE	BUSINESS	Q.S / P.C	PRICE
CUCH630.FOS	fossil	•	€ 134

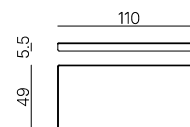



CH3110 Bench with armrest / Panca con bracciolo

Galvanized steel / Acciaio zincato

Stackable / Impilabile (4 pcs)

Weight / Peso : 14,5 Kg

packaging / imballo  1  0,78  21 CM L 151 P 94 H 55

Frame / Struttura

CODE / CODICE	FRAME / STRUTTURA	Q.S / P.C	PRICE / €
CH3110.AG	ancient grey / grigio antico	•	€ 396
CH3110.BRO	bronze / bronzo		€ 396
CH3110.FA	mud grey / fango		€ 396
CH3110.BS	ivory white / bianco perla		€ 396
CH3110.ME	mint green / menta		€ 396
CH3110.TC	terracotta / terracotta		€ 396
CH3110.CO	corten / corten		€ 396
CH3110.BCU	matt white / bianco gofrato		€ 396

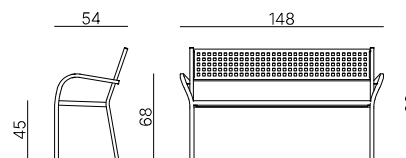

CUCH3109 Seat Cushion / Cuscino seduta (for / per CH3110)

Washable / Lavabile

Waterproof gel-backing / Fodera impermeabile

Weight / Peso : 2 Kg

packaging / imballo  1  1  3 CM L 151 P 51 H 6

Cushion fabric set / Tessuti set cuscineria

CODE / CODICE	BUSINESS	Q.S / P.C	PRICE
CUCH3109.FOS	fossil	•	€ 116
CUCH3109.ECS	ecru		€ 116
CUCH3109.TPS	taupe		€ 116
CUCH3109.BRS	brisa		€ 116
CUCH3109.GRS	grey		€ 116
CUCH3109.ANS	anthracite		€ 116

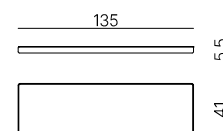



CH413 Sunbed / Lettino

Galvanized steel and Aluminium / Acciaio zincato e alluminio

Batylane fabric / Tessuto Batylane

Stackable / Impilabile (10 pcs)

Weight / Peso : 15 Kg

packaging / imballo  2  0,95  38 CM L 204 P 83 H 56

Frame / Struttura

CODE / CODICE	FRAME / STRUTTURA	BATYLINE	Q.S / P.C	PRICE / €
CH413.AG/NE	ancient grey / grigio antico	black / nero	•	€ 518
CH413.FA/TO	mud grey / fango	taupe / tortora	•	€ 518
CH413.BS/BCO	ivory white / bianco perla	white / bianco	•	€ 518

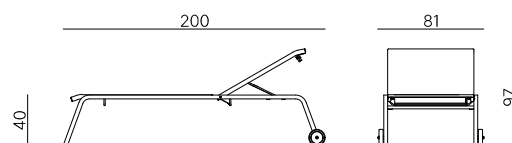



PS413 Sunshade / Tettino parasole

Galvanized steel and Aluminium / Acciaio zincato e alluminio

Batylane fabric / Tessuto Batylane

Stackable / Impilabile (10 pcs)

Weight / Peso : 2 Kg

packaging / imballo  1  0,03  3 CM L 70 P 67 H 7

CODE / CODICE	FRAME / STRUTTURA	BATYLINE	Q.S / P.C	PRICE / €
PS413.AG/NE	ancient grey / grigio antico	black / nero		€ 203
PS413.FA/TO	mud grey / fango	taupe / tortora		€ 203
PS413.BS/BCO	ivory white / bianco perla	white / bianco		€ 203

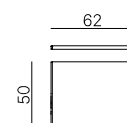



Alice

CH904 Table base / Base tavolo

Galvanized steel / Acciaio zincato
Knockdown / Smontabile

Tabletops / Piani tavolo pag. 162
Weight / Peso : 7,5 Kg

packaging / imballo  5  0,27  41 CM L 90 P 60 H 50

Frame / Struttura

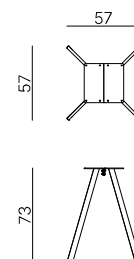

CODE / CODICE	FRAME / STRUTTURA	Q.S / P.C	PRICE / €
CH904.AG	ancient grey / grigio antico	•	€ 148
CH904.BRO	bronze / bronzo		€ 148
CH904.FA	mud grey / fango		€ 148
CH904.BS	ivory white / bianco perla		€ 148
CH904.ME	mint green / menta		€ 148
CH904.TC	terracotta / terracotta		€ 148
CH904.CO	corten / corten		€ 148
CH904.BCU	matt white / bianco goffrato		€ 148



CH904H High table base / Base tavolo alta

Galvanized steel / Acciaio zincato
Knockdown / Smontabile

Tabletops / Piani tavolo pag. 162
Weight / Peso : 9,5 Kg

packaging / imballo  2  0,17  22 CM L 115 P 60 H 24

Frame / Struttura

CODE / CODICE	FRAME / STRUTTURA	Q.S / P.C	PRICE / €
CH904H.AG	ancient grey / grigio antico	•	€ 179
CH904H.BRO	bronze / bronzo		€ 179
CH904H.FA	mud grey / fango		€ 179
CH904H.BS	ivory white / bianco perla		€ 179
CH904H.ME	mint green / menta		€ 179
CH904H.TC	terracotta / terracotta		€ 179
CH904H.CO	corten / corten		€ 179
CH904H.BCU	matt white / bianco goffrato		€ 179

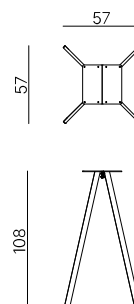



Aria

Designed by Studio Solido



frame / struttura

standard colours / colori standard

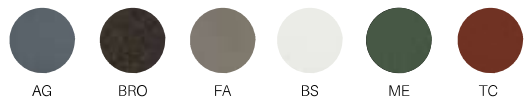

AG

BRO

FA

BS

ME



TC

More information on colors and fabrics from page 194 / Più informazioni su colori e tessuti da pagina 194

AI60L Coffee table / Tavolo basso ø 60

Galvanized steel / Acciaio zincato

Knockdown / Smontabile

Weight / Peso : 6 Kgpackaging / imballo  1  0,03  7 CM L 61 P 61 H 8**Frame / Struttura**

CODE / CODICE	FRAME / STRUTTURA	Q.S / P.C	PRICE / €
AI60L.AG	ancient grey / grigio antico		€ 254
AI60L.BRO	bronze / bronzo		€ 254
AI60L.FA	mud grey / fango		€ 254
AI60L.BS	ivory white / bianco perla		€ 254
AI60L.ME	mint green / menta		€ 254
AI60L.TC	terracotta / terracotta		€ 254

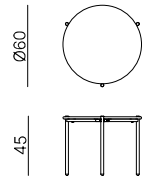
**AI90L Coffee table / Tavolo basso ø 90**

Galvanized steel / Acciaio zincato

Knockdown / Smontabile

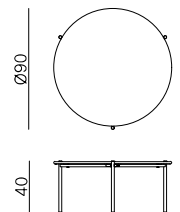

Weight / Peso : 12,5 Kgpackaging / imballo  1  0,07  13 CM L 92 P 92 H 8**Frame / Struttura**

CODE / CODICE	FRAME / STRUTTURA	Q.S / P.C	PRICE / €
AI90L.AG	ancient grey / grigio antico		€ 431
AI90L.BRO	bronze / bronzo		€ 431
AI90L.FA	mud grey / fango		€ 431
AI90L.BS	ivory white / bianco perla		€ 431
AI90L.ME	mint green / menta		€ 431
AI90L.TC	terracotta / terracotta		€ 431

**AI110L Coffee table / Tavolo basso ø 110**

Galvanized steel / Acciaio zincato

Knockdown / Smontabile

Weight / Peso : 16,5 Kgpackaging / imballo  1  0,10  17 CM L 112 P 112 H 8**Frame / Struttura**

CODE / CODICE	FRAME / STRUTTURA	Q.S / P.C	PRICE / €
AI110L.AG	ancient grey / grigio antico		€ 537
AI110L.BRO	bronze / bronzo		€ 537
AI110L.FA	mud grey / fango		€ 537
AI110L.BS	ivory white / bianco perla		€ 537
AI110L.ME	mint green / menta		€ 537
AI110L.TC	terracotta / terracotta		€ 537

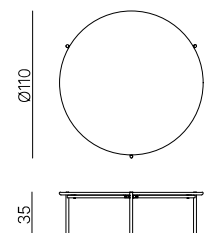

Bistrot

Designed by Vermobil Team





frame / struttura

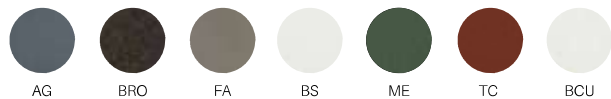



standard colours / colori standard

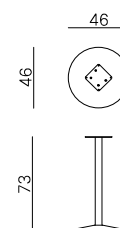

More information on colors and fabrics from page 194 / Più informazioni su colori e tessuti da pagina 194

BI904 Table base / Base tavoloGalvanized steel / Acciaio zincato
Knockdown / SmontabileTabletops / Piani tavolo pag. 162
Weight / Peso : 9,5 Kgpackaging / imballo  2  0,06  21 CM L 70 P 55 H 18**Frame / Struttura**

CODE / CODICE	FRAME / STRUTTURA	Q.S / P.C	PRICE / €
BI904.AG	ancient grey / grigio antico	•	€ 203
BI904.BRO	bronze / bronzo		€ 203
BI904.FA	mud grey / fango		€ 203
BI904.BS	ivory white / bianco perla		€ 203
BI904.ME	mint green / menta		€ 203
BI904.TC	terracotta / terracotta		€ 203
BI904.BCU	matt white / bianco goffrato		€ 203

**BI904H High table base / Base tavolo alta**Galvanized steel / Acciaio zincato
Knockdown / SmontabileTabletops / Piani tavolo pag. 162
Weight / Peso : 10 Kgpackaging / imballo  2  0,12  23 CM L 110 P 60 H 18**Frame / Struttura**

CODE / CODICE	FRAME / STRUTTURA	Q.S / P.C	PRICE / €
BI904H.AG	ancient grey / grigio antico	•	€ 227
BI904H.BRO	bronze / bronzo		€ 227
BI904H.FA	mud grey / fango		€ 227
BI904H.BS	ivory white / bianco perla		€ 227
BI904H.ME	mint green / menta		€ 227
BI904H.TC	terracotta / terracotta		€ 227
BI904H.BCU	matt white / bianco goffrato		€ 227

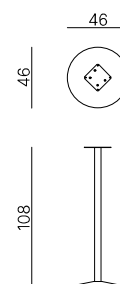

Bundi

Designed by Vermobil Team



frame / struttura

standard colours / colori standard

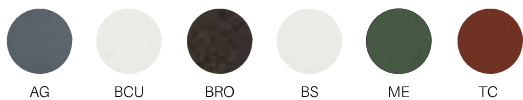

HPL



BU16090S (SEMI-OVAL LEGS / GAMBE SEMIOVALI)

(1x PIABU16090 + 1x SABU160 + 1x GABUS)

TOTAL PRICE METAL TABLETOP / PREZZO TOTALE TAVOLO CON PIANO IN METALLO 160x90 € 1.130

BU16090Q (SQUARE LEGS / GAMBE QUADRATE)

(1x PIABU16090 + 1x SABU160 + 1x GABUQ)

TOTAL PRICE METAL TABLETOP / PREZZO TOTALE TAVOLO CON PIANO IN METALLO 160x90 € 1.130

BU16090HS (SEMI-OVAL LEGS / GAMBE SEMIOVALI)

(1x PIABU16090H + 1x SABU160 + 1x GABUS)

TOTAL PRICE HPL TABLETOP / PREZZO TOTALE TAVOLO CON PIANO IN HPL 160x90 € 1.659

BU16090HQ (SQUARE LEGS / GAMBE QUADRATE)

(1x PIABU16090H + 1x SABU160 + 1x GABUQ)

TOTAL PRICE HPL TABLETOP / PREZZO TOTALE TAVOLO CON PIANO IN HPL 160x90 € 1.659

BU21090S (SEMI-OVAL LEGS / GAMBE SEMIOVALI)

(1x PIABU21090 + 1x SABU210 + 1x GABUS)

TOTAL PRICE METAL TABLETOP / PREZZO TOTALE TAVOLO CON PIANO IN METALLO 210x90 € 1.284

BU21090Q (SQUARE LEGS / GAMBE QUADRATE)

(1x PIABU21090 + 1x SABU210 + 1x GABUQ)

TOTAL PRICE METAL TABLETOP / PREZZO TOTALE TAVOLO CON PIANO IN METALLO 210x90 € 1.284

BU21090HS (SEMI-OVAL LEGS / GAMBE SEMIOVALI)

(1x PIABU21090H + 1x SABU210 + 1x GABUS)

TOTAL PRICE HPL TABLETOP / PREZZO TOTALE TAVOLO CON PIANO IN HPL 210x90 € 2.047

BU21090HQ (SQUARE LEGS / GAMBE QUADRATE)

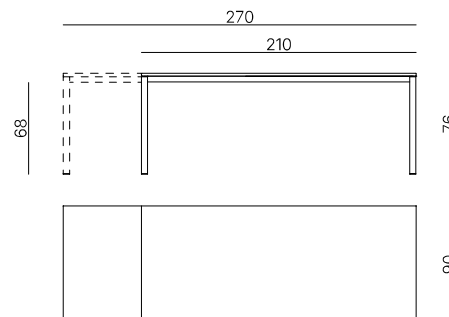
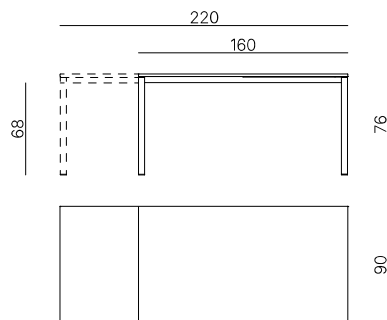

(1x PIABU21090H + 1x SABU210 + 1x GABUQ)

TOTAL PRICE HPL TABLETOP / PREZZO TOTALE TAVOLO CON PIANO IN HPL 210x90 € 2.047



PIABU16090 Metal tabletop and extension / Piano e prolunga in metallo 160+60×90

Galvanized steel / Acciaio zincato
 Tabletop thickness / Spessore piano 18mm
Weight / Peso : 31 Kg



packaging / imballo  1  0,1  36 CM L 165 P 95 H 6

Frame / Struttura

CODE / CODICE	FRAME / STRUTTURA	Q.S / P.C	PRICE / €
PIABU16090.AG	ancient grey / grigio antico		€ 482
PIABU16090.BCU	matt white / bianco goffrato		€ 482
PIABU16090.BRO	bronze / bronzo		€ 482
PIABU16090.BS	ivory white / bianco perla		€ 482
PIABU16090.ME	mint green / menta		€ 482
PIABU16090.TC	terracotta / terracotta		€ 482

PIABU21090 Metal tabletop and extension / Piano e prolunga in metallo 210+60×90

Galvanized steel / Acciaio zincato
 Tabletop thickness / Spessore piano 18mm
Weight / Peso : 38 Kg

packaging / imballo  1  0,13  44 CM L 215 P 95 H 6

Frame / Struttura

CODE / CODICE	FRAME / STRUTTURA	Q.S / P.C	PRICE / €
PIABU21090.AG	ancient grey / grigio antico		€ 598
PIABU21090.BCU	matt white / bianco goffrato		€ 598
PIABU21090.BRO	bronze / bronzo		€ 598
PIABU21090.BS	ivory white / bianco perla		€ 598
PIABU21090.ME	mint green / menta		€ 598
PIABU21090.TC	terracotta / terracotta		€ 598

PIABU16090H HPL tabletop and extension / Piano e prolunga in HPL 160+60×90

HPL
 Tabletop thickness / Spessore piano 10mm
Weight / Peso : 31 Kg

packaging / imballo  1  0,1  36 CM L 165 P 95 H 6

Frame / Struttura

CODE / CODICE	FRAME / STRUTTURA	Q.S / P.C	PRICE / €
PIABU16090H.CE	ash grey / cenere		€ 1.011
PIABU16090H.SA	samoa		€ 1.011

Bundi

PIABU21090H HPL tabletop and extension / Piano e prolunga in HPL 210+60×90

HPL

Tabletop thickness / Spessore piano 10mm

Weight / Peso : 38 Kg

packaging / imballo  1  0,13  44 CM L 215 P 95 H 6

Frame / Struttura



CODE / CODICE	FRAME / STRUTTURA	Q.S / P.C	PRICE / €
PIABU21090H.CE	ash grey / cenere		€ 1.361
PIABU21090H.SA	samoa		€ 1.361

SABU160 Extendable system / Sistema allungabile 160cm

Aluminium / Alluminio

Stainless steel ball bearings / Cuscinetti a sfera in acciaio inox

Weight / Peso : 8 Kg

packaging / imballo  1  0,032  9 CM L 160 P 25 H 8

Frame / Struttura

CODE / CODICE	FRAME / STRUTTURA	Q.S / P.C	PRICE / €
SABU160.NE	black / nero		€ 482
SABU160.BCO	white / bianco		€ 482

SABU210 Extendable system / Sistema allungabile 210cm

Aluminium / Alluminio

Stainless steel ball bearings / Cuscinetti a sfera in acciaio inox

Weight / Peso : 10 Kg



packaging / imballo  1  0,042  11,5 CM L 210 P 25 H 8

Frame / Struttura

CODE / CODICE	FRAME / STRUTTURA	Q.S / P.C	PRICE / €
SABU210.NE	black / nero		€ 520
SABU210.BCO	white / bianco		€ 520

GABUS Semi-oval legs kit / Kit di gambe semiovali

Galvanized steel / Acciaio zincato
Semi-oval leg / Gamba semiovale 50x25mm
Weight / Peso : 8 Kg



packaging / imballo  1  0,05  10 CM L 100 P 72 H 7

Frame / Struttura

CODE / CODICE	FRAME / STRUTTURA	Q.S / P.C	PRICE / €
GABUS.AG	ancient grey / grigio antico		€ 166
GABUS.BCU	matt white / bianco goffrato		€ 166
GABUS.BRO	bronze / bronzo		€ 166
GABUS.BS	ivory white / bianco perla		€ 166
GABUS.ME	mint green / menta		€ 166
GABUS.TC	terracotta / terracotta		€ 166

GABUQ Square legs kit / Kit di gambe quadrate

Galvanized steel / Acciaio zincato
Square leg / Gamba quadrata 60x60mm
Weight / Peso : 15 Kg

packaging / imballo  1  0,05  17 CM L 100 P 72 H 7

Frame / Struttura

CODE / CODICE	FRAME / STRUTTURA	Q.S / P.C	PRICE / €
GABUQ.AG	ancient grey / grigio antico		€ 166
GABUQ.BCU	matt white / bianco goffrato		€ 166
GABUQ.BRO	bronze / bronzo		€ 166
GABUQ.BS	ivory white / bianco perla		€ 166
GABUQ.ME	mint green / menta		€ 166
GABUQ.TC	terracotta / terracotta		€ 166

Ciao

Designed by Vermobil Team



frame / struttura

standard colours / colori standard



AG BRO ME TC CO

fabrics / tessuti

business

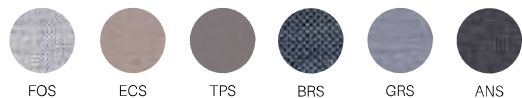



FOS ECS TPS BRS GRS ANS

More information on colors and fabrics from page 194 / Più informazioni su colori e tessuti da pagina 194

CI100 Chair / Sedia

Galvanized steel / Acciaio zincato

Stackable / Impilabile (8 pcs)

Weight / Peso : 4 Kgpackaging / imballo  4  0,31  18 cm L 115 P 54 H 50

Frame / Struttura

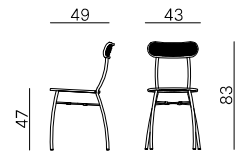

CODE / CODICE	FRAME / STRUTTURA	Q.S / P.C	PRICE / €
CI100.AG	ancient grey / grigio antico	•	€ 129
CI100.BRO	bronze / bronzo		€ 129
CI100.ME	mint green / menta		€ 129
CI100.TC	terracotta / terracotta		€ 129
CI100.CO	corten / corten		€ 129



CI300 Armchair / Poltrona

Galvanized steel / Acciaio zincato

Stackable / Impilabile (8 pcs)

Weight / Peso : 4,5 Kgpackaging / imballo  4  0,37  20 cm L 115 P 54 H 60

Frame / Struttura

CODE / CODICE	FRAME / STRUTTURA	Q.S / P.C	PRICE / €
CI300.AG	ancient grey / grigio antico	•	€ 153
CI300.BRO	bronze / bronzo		€ 153
CI300.ME	mint green / menta		€ 153
CI300.TC	terracotta / terracotta		€ 153
CI300.CO	corten / corten		€ 153

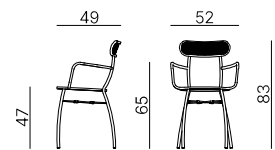

CUSRM37 Seat cushion / Cuscino seduta (for / per CI100, CI300)

Non-removable / Non sfoderabile

Anti-slip / Antiscivolo

With magnet / Con calamita

Washable / Lavabile

Waterproof gel-backing / Fodera impermeabile

Weight / Peso : 0,2 Kgpackaging / imballo  1  0,01  0,4 cm L 39 P 39 H 3

Cushion fabric set / Tessuti set cuscineria

CODE / CODICE	BUSINESS	Q.S / P.C	PRICE
CUSRM37.FOS	fossil	•	€ 45
CUSRM37.ECS	ecru		€ 45
CUSRM37.TPS	taupe		€ 45
CUSRM37.BRS	brisa		€ 45
CUSRM37.GRS	grey		€ 45
CUSRM37.ANS	anthracite		€ 45

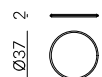

Daisy

Designed by Vermobil Team



frame / struttura

standard colours / colori standard

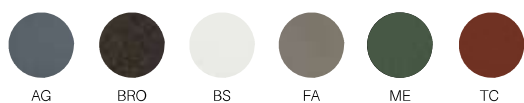

fabrics / tessuti

business

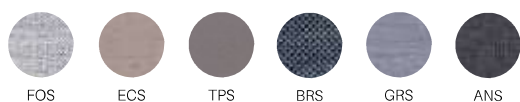

sunset

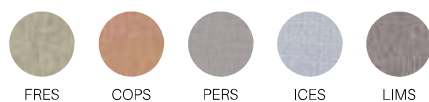

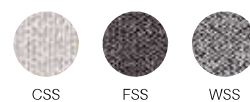

avant-garde



Pillow pag. 174

More information on colors and fabrics from page 194 / Più informazioni su colori e tessuti da pagina 194



Manufacturer's suggested retail price, VAT not included / Prezzo consigliato di vendita al pubblico, IVA esclusa.

DE301 Armchair / PoltronaGalvanized steel / Acciaio zincato
Stackable / Impilabile (2 pcs)**CATAS**
Weight / Peso : 6,5 Kgpackaging / imballo  2  0,30  15 CM L 83 P 57 H 63**Frame / Struttura**

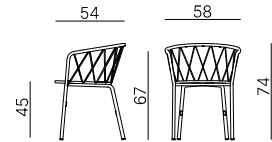

CODE / CODICE	FRAME / STRUTTURA	Q.S / P.C	PRICE / €
DE301.AG	ancient grey / grigio antico	•	€ 210
DE301.BRO	bronze / bronzo		€ 210
DE301.BS	ivory white / bianco perla	•	€ 210
DE301.FA	mud grey / fango	•	€ 210
DE301.ME	mint green / menta		€ 210
DE301.TC	terracotta / terracotta		€ 210

**SCHDE301 Backrest / Schienale (for / per DE301)**Galvanized steel / Acciaio zincato
Knockdown / Smontabile

Weight / Peso : 0,5 Kg

packaging / imballo  1  0,05  0,7 CM L 31 P 10 H 14**Frame / Struttura**

CODE / CODICE	FRAME / STRUTTURA	Q.S / P.C	PRICE / €
SCHDE301.AG	ancient grey / grigio antico	•	€ 38
SCHDE301.BRO	bronze / bronzo		€ 38
SCHDE301.BS	ivory white / bianco perla	•	€ 38
SCHDE301.FA	mud grey / fango	•	€ 38
SCHDE301.ME	mint green / menta		€ 38
SCHDE301.TC	terracotta / terracotta		€ 38

**CUSRM43 Seat cushion / Cuscino seduta (for / per DE301)**Non-removable / Non sfoderabile
Anti-slip / Antiscivolo
With magnet / Con calamitaWashable / Lavabile
Waterproof gel-backing / Fodera impermeabile
Weight / Peso : 0,2 Kgpackaging / imballo  1  0,01  0,7 CM L 44 P 44 H 3**Cushion fabric set / Tessuti set cuscineria**

CODE / CODICE	BUSINESS	Q.S / P.C	PRICE	CODE / CODICE	SUNSET	Q.S / P.C	PRICE	CODE / CODICE	AVANT GARDE	Q.S / P.C	PRICE
CUSRM43.FOS	fossil	•	€ 45	CUSRM43.FRES	fresh		€ 54	CUSRM43.CSS	cream star		€ 54
CUSRM43.ECS	ecru		€ 45	CUSRM43.COPS	copper		€ 54	CUSRM43.FSS	mud grey star		€ 54
CUSRM43.TPS	taupe		€ 45	CUSRM43.PERS	pergamino		€ 54	CUSRM43.WSS	white star		€ 54
CUSRM43.BRS	brisa		€ 45	CUSRM43.ICES	ice		€ 54				
CUSRM43.GRS	grey		€ 45	CUSRM43.LIMS	limestone		€ 54				
CUSRM43.ANS	anthracite		€ 45								

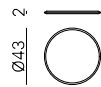

Daisy

DE600 Lounge chair / Poltrona bassa

TOTAL PRICE WITH BUSINESS CUSHIONS / PREZZO TOTALE CON CUSCINI BUSINESS € 644

TOTAL PRICE WITH SUNSET CUSHIONS / PREZZO TOTALE CON CUSCINI SUNSET € 709

TOTAL PRICE WITH AVANT-GARDE CUSHIONS / PREZZO TOTALE CON CUSCINI AVANT-GARDE € 709

Galvanized steel / Acciaio zincato



Seat and back cushion included / Cuscino seduta e schienale inclusi

Removable Cushions / Cuscini sfoderabili

Washable / Lavabile

Waterproof gel-backing / Fodera impermeabile

Weight / Peso : 10 Kg

packaging / imballo  1  0,49  16 CM L 83 P 76 H 77

Frame / Struttura

CODE / CODICE	FRAME / STRUTTURA	Q.S / P.C	PRICE / €
DE600.AG	ancient grey / grigio antico	•	€ 408
DE600.BRO	bronze / bronzo		€ 408
DE600.BS	ivory white / bianco perla	•	€ 408
DE600.FA	mud grey / fango	•	€ 408
DE600.ME	mint green / menta		€ 408
DE600.TC	terracotta / terracotta		€ 408

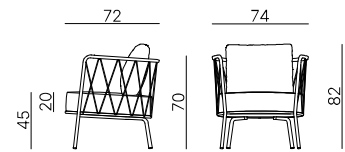

Cushion fabric set / Tessuti set cuscineria (1 seat cushion + 1 back cushion / 1 cuscino seduta + 1 cuscini schienale)

CODE / CODICE	BUSINESS	Q.S / P.C	PRICE	CODE / CODICE	SUNSET	Q.S / P.C	PRICE	CODE / CODICE	AVANT GARDE	Q.S / P.C	PRICE
DE600KIT.FOS	fossil	•	€ 236	DE600KIT.FRES	fresh		€ 301	DE600KIT.CSS	cream star		€ 301
DE600KIT.ECS	ecru		€ 236	DE600KIT.COPS	copper		€ 301	DE600KIT.FSS	mud grey star		€ 301
DE600KIT.TPS	taupe		€ 236	DE600KIT.PERS	pergamino		€ 301	DE600KIT.WSS	white star		€ 301
DE600KIT.BRS	brisa		€ 236	DE600KIT.ICES	ice		€ 301				
DE600KIT.GRS	grey		€ 236	DE600KIT.LIMS	limestone		€ 301				
DE600KIT.ANS	anthracite		€ 236								

DE630 2 seater sofa / Divano 2 posti

TOTAL PRICE WITH BUSINESS CUSHIONS / PREZZO TOTALE CON CUSCINI BUSINESS	€ 1.322
TOTAL PRICE WITH SUNSET CUSHIONS / PREZZO TOTALE CON CUSCINI SUNSET	€ 1.453
TOTAL PRICE WITH AVANT-GARDE CUSHIONS / PREZZO TOTALE CON CUSCINI AVANT-GARDE	€ 1.453

Galvanized steel / Acciaio zincato
 Seat and back cushion included / Cuscino seduta e schienale inclusi
 Removable Cushions / Cuscini sfoderabili

Washable / Lavabile
 Waterproof gel-backing / Fodera impermeabile
Weight / Peso : 27 Kg

packaging / imballo  1  1,04  32 CM L 167 P 81 H 77

Frame / Struttura

CODE / CODICE	FRAME / STRUTTURA	Q.S / P.C	PRICE / €
DE630.AG	ancient grey / grigio antico	•	€ 799
DE630.BRO	bronze / bronzo		€ 799
DE630.BS	ivory white / bianco perla	•	€ 799
DE630.FA	mud grey / fango	•	€ 799
DE630.ME	mint green / menta		€ 799
DE630.TC	terracotta / terracotta		€ 799

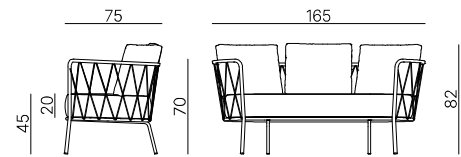
**Cushion fabric set / Tessuti set cuscineria (1 seat cushion + 3 back cushion / 1 cuscino seduta + 3 cuscini schienale)**

CODE / CODICE	BUSINESS	Q.S / P.C	PRICE	CODE / CODICE	SUNSET	Q.S / P.C	PRICE	CODE / CODICE	AVANT GARDE	Q.S / P.C	PRICE
DE630KIT.FOS	fossil	•	€ 523	DE630KIT.FRES	fresh		€ 654	DE630KIT.CSS	cream star		€ 654
DE630KIT.ECS	ecru		€ 523	DE630KIT.COPS	copper		€ 654	DE630KIT.FSS	mud grey star		€ 654
DE630KIT.TPS	taupe		€ 523	DE630KIT.PERS	pergamino		€ 654	DE630KIT.WSS	white star		€ 654
DE630KIT.BRS	brisa		€ 523	DE630KIT.ICES	ice		€ 654				
DE630KIT.GRS	grey		€ 523	DE630KIT.LIMS	limestone		€ 654				
DE630KIT.ANS	anthracite		€ 523								

Daisy

DE730 3 seater sofa / Divano 3 posti

TOTAL PRICE WITH BUSINESS CUSHIONS / PREZZO TOTALE CON CUSCINI BUSINESS	€ 1.877
TOTAL PRICE WITH SUNSET CUSHIONS / PREZZO TOTALE CON CUSCINI SUNSET	€ 2.065
TOTAL PRICE WITH AVANT-GARDE CUSHIONS / PREZZO TOTALE CON CUSCINI AVANT-GARDE	€ 2.065

Galvanized steel / Acciaio zincato



Seat and back cushion included / Cuscino seduta e schienale inclusi

Removable Cushions / Cuscini sfoderabili

Washable / Lavabile

Waterproof gel-backing / Fodera impermeabile

Weight / Peso : 40 Kg

packaging / imballo  1  1,32  47 CM L 220 P 78 H 77

Frame / Struttura

CODE / CODICE	FRAME / STRUTTURA	Q.S / P.C	PRICE / €
DE730.AG	ancient grey / grigio antico		€ 1.064
DE730.BRO	bronze / bronzo		€ 1.064
DE730.BS	ivory white / bianco perla		€ 1.064
DE730.FA	mud grey / fango		€ 1.064
DE730.ME	mint green / menta		€ 1.064
DE730.TC	terracotta / terracotta		€ 1.064

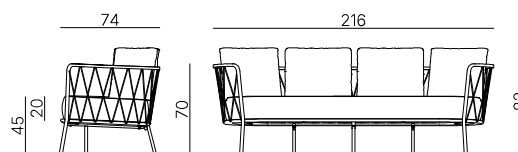



Cushion fabric set / Tessuti set cuscineria (1 seat cushion + 4 back cushions / 1 cuscino seduta + 4 cuscini schienale)

CODE / CODICE	BUSINESS	Q.S / P.C	PRICE	CODE / CODICE	SUNSET	Q.S / P.C	PRICE	CODE / CODICE	AVANT GARDE	Q.S / P.C	PRICE
DE730KIT.FOS	fossil		€ 690	DE730KIT.FRES	fresh		€ 857	DE730KIT.CSS	cream star		€ 857
DE730KIT.ECS	ecru		€ 690	DE730KIT.COPS	copper		€ 857	DE730KIT.FSS	mud grey star		€ 857
DE730KIT.TPS	taupe		€ 690	DE730KIT.PERS	pergamino		€ 857	DE730KIT.WSS	white star		€ 857
DE730KIT.BRS	brisa		€ 690	DE730KIT.ICES	ice		€ 857				
DE730KIT.GRS	grey		€ 690	DE730KIT.LIMS	limestone		€ 857				
DE730KIT.ANS	anthracite		€ 690								

DE43 Occasional table / Tavolo basso ø 43

Galvanized steel / Acciaio zincato

Weight / Peso : 3,8 Kg

packaging / imballo  1  0,09  5 CM L 44 P 44 H 46

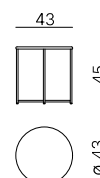

Frame / Struttura

CODE / CODICE	FRAME / STRUTTURA	Q.S / P.C	PRICE / €
DE43.AG	ancient grey / grigio antico		€ 136
DE43.BRO	bronze / bronzo		€ 136
DE43.BS	ivory white / bianco perla		€ 136
DE43.FA	mud grey / fango		€ 136
DE43.ME	mint green / menta		€ 136
DE43.TC	terracotta / terracotta		€ 136



DE60 Occasional table / Tavolo basso ø 60

Galvanized steel / Acciaio zincato



Weight / Peso : 5 Kgpackaging / imballo  1  0,19  7 CM L 64 P 64 H 46

Frame / Struttura

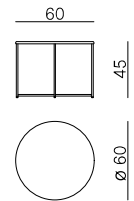
CODE / CODICE	FRAME / STRUTTURA	Q.S / P.C	PRICE / €
DE60.AG	ancient grey / grigio antico		€ 181
DE60.BRO	bronze / bronzo		€ 181
DE60.BS	ivory white / bianco perla		€ 181
DE60.FA	mud grey / fango		€ 181
DE60.ME	mint green / menta		€ 181
DE60.TC	terracotta / terracotta		€ 181

**DE90 Occasional table / Tavolo basso ø 90**

Galvanized steel / Acciaio zincato



Weight / Peso : 11 Kgpackaging / imballo  1  0,41  13 CM L 94 P 94 H 46

Frame / Struttura

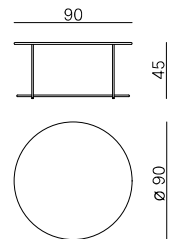
CODE / CODICE	FRAME / STRUTTURA	Q.S / P.C	PRICE / €
DE90.AG	ancient grey / grigio antico		€ 293
DE90.BRO	bronze / bronzo		€ 293
DE90.BS	ivory white / bianco perla		€ 293
DE90.FA	mud grey / fango		€ 293
DE90.ME	mint green / menta		€ 293
DE90.TC	terracotta / terracotta		€ 293

**DE201 Occasional table / Tavolo basso ø 65**

Galvanized steel / Acciaio zincato

Weight / Peso : 6 Kgpackaging / imballo  1  0,20  8 CM L 68 P 68 H 43

Frame / Struttura

CODE / CODICE	FRAME / STRUTTURA	Q.S / P.C	PRICE / €
DE201.AG	ancient grey / grigio antico	•	€ 189
DE201.BRO	bronze / bronzo		€ 189
DE201.BS	ivory white / bianco perla	•	€ 189
DE201.FA	mud grey / fango	•	€ 189
DE201.ME	mint green / menta		€ 189
DE201.TC	terracotta / terracotta		€ 189

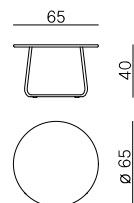

Daisy

DE151KIT Occasional tables Kit / Kit Tavoli bassi

Galvanized steel / Acciaio zincato

Weight / Peso : 8,8 Kg

packaging / imballo  1  0,09  10 CM L 52 P 42 H 42

Frame / Struttura

CODE / CODICE	FRAME / STRUTTURA	Q.S / P.C	PRICE / €
DE151KIT.AG	ancient grey / grigio antico		€ 325
DE151KIT.BRO	bronze / bronzo		€ 325
DE151KIT.BS	ivory white / bianco perla		€ 325
DE151KIT.FA	mud grey / fango		€ 325
DE151KIT.ME	mint green / menta		€ 325
DE151KIT.TC	terracotta / terracotta		€ 325

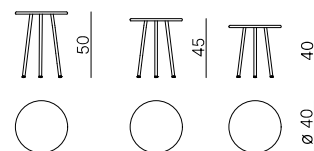



DE18591 Table / Tavolo 185×90

Galvanized steel / Acciaio zincato

Knockdown / Smontabile

Leveling glide / Piedino regolabile

Weight / Peso : 40 Kg

packaging / imballo  1  0,29  49 CM L 190 P 19 H 81

Frame / Struttura

CODE / CODICE	FRAME / STRUTTURA	Q.S / P.C	PRICE / €
DE18591.AG	ancient grey / grigio antico		€ 931
DE18591.BRO	bronze / bronzo		€ 931
DE18591.BS	ivory white / bianco perla		€ 931
DE18591.FA	mud grey / fango		€ 931
DE18591.ME	mint green / menta		€ 931
DE18591.TC	terracotta / terracotta		€ 931

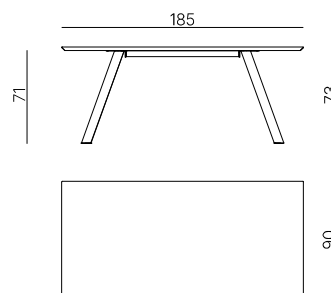

DE4301 Extendable table / Tavolo allungabile 220/320×100



Galvanized steel / Acciaio zincato

Extension / Prolunga 100cm

Knockdown / Smontabile

Leveling glide / Piedino regolabile

Weight / Peso : 113 Kg

packaging / imballo  1/2  0,49  111 CM L 235 P 115 H 18

 2/2  0,10  14 CM L 82 P 70 H 17

Frame / Struttura

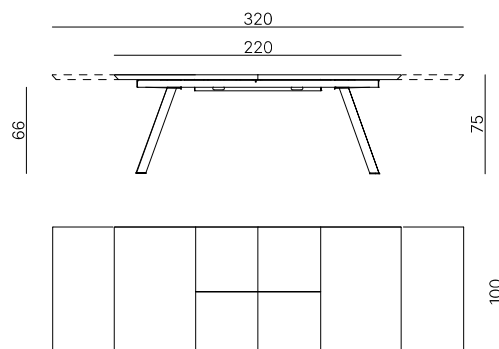

CODE / CODICE	FRAME / STRUTTURA	Q.S / P.C	PRICE / €
DE4301.AG	ancient grey / grigio antico		€ 2.648
DE4301.BRO	bronze / bronzo		€ 2.648
DE4301.BS	ivory white / bianco perla		€ 2.648
DE4301.FA	mud grey / fango		€ 2.648
DE4301.ME	mint green / menta		€ 2.648
DE4301.TC	terracotta / terracotta		€ 2.648



DE904 Table base / Base tavolo

Galvanized steel / Acciaio zincato
Knockdown / Smontabile
Tabletops / Piani tavolo pag. 162

Leveling glide / Piedino regolabile
Weight / Peso : 9 Kg

packaging / imballo  1  0,10  14 CM L 82 P 70 H 17

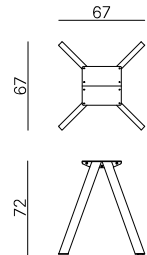

Frame / Struttura

CODE / CODICE	FRAME / STRUTTURA	Q.S / P.C	PRICE / €
DE904.AG	ancient grey / grigio antico		€ 245
DE904.BRO	bronze / bronzo		€ 245
DE904.BS	ivory white / bianco perla		€ 245
DE904.FA	mud grey / fango		€ 245
DE904.ME	mint green / menta		€ 245
DE904.TC	terracotta / terracotta		€ 245

**FUDE650 Table base / Base tavolo**

Galvanized steel / Acciaio zincato
Tabletops / Piani tavolo pag. 162

Weight / Peso : 7 Kg

packaging / imballo  1  0,21  11 CM L 53 P 53 H 74

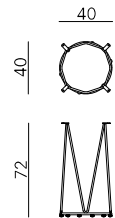

Frame / Struttura

CODE / CODICE	FRAME / STRUTTURA	Q.S / P.C	PRICE / €
FUDE650.AG	ancient grey / grigio antico		€ 180
FUDE650.BRO	bronze / bronzo		€ 180
FUDE650.BS	ivory white / bianco perla		€ 180
FUDE650.FA	mud grey / fango		€ 180
FUDE650.ME	mint green / menta		€ 180
FUDE650.TC	terracotta / terracotta		€ 180

**FUDE900 Table base / Base tavolo**

Galvanized steel / Acciaio zincato
Tabletops / Piani tavolo pag. 162

Weight / Peso : 9 Kg

packaging / imballo  1  0,31  13 CM L 65 P 65 H 74

Frame / Struttura

CODE / CODICE	FRAME / STRUTTURA	Q.S / P.C	PRICE / €
FUDE900.AG	ancient grey / grigio antico		€ 293
FUDE900.BRO	bronze / bronzo		€ 293
FUDE900.BS	ivory white / bianco perla		€ 293
FUDE900.FA	mud grey / fango		€ 293
FUDE900.ME	mint green / menta		€ 293
FUDE900.TC	terracotta / terracotta		€ 293

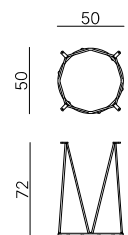



Daisy

FUDE1300 Table base / Base tavolo

Galvanized steel / Acciaio zincato

Tabletops / Piani tavolo pag. 162

Weight / Peso : 15 Kg

packaging / imballo  1  0,41  17 CM L 73 P 73 H 74

Frame / Struttura

CODE / CODICE	FRAME / STRUTTURA	Q.S / P.C	PRICE / €
FUDE1300.AG	ancient grey / grigio antico		€ 316
FUDE1300.BRO	bronze / bronzo		€ 316
FUDE1300.BS	ivory white / bianco perla		€ 316
FUDE1300.FA	mud grey / fango		€ 316
FUDE1300.ME	mint green / menta		€ 316
FUDE1300.TC	terracotta / terracotta		€ 316





FUDE650 +
PIA65T



FUDE900 +
PIA110T



FUDE1300 +
PIA130T

Daisy Rope

Designed by Vermobil Team



frame / struttura

standard colours / colori standard

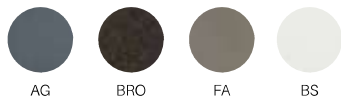

fabrics / tessuti

business

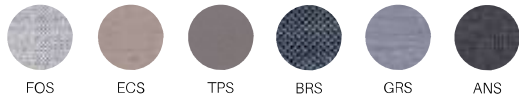

sunset



avant-garde



rope / corda





Pillow Pag. 174

More information on colors and fabrics from page 194 / Più informazioni su colori e tessuti da pagina 194

DE30XI Armchair / Poltrona



Stainless steel AISI 316 L / Acciaio inossidabile AISI 316 L

Weight / Peso : 6,5 Kgpackaging / imballo  2  0,37  15 CM L 99 P 63 H 59**Frame / Struttura**

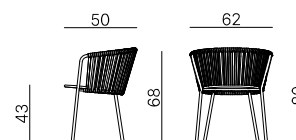
CODE / CODICE	FRAME / STRUTTURA	ROPE / CORDA	Q.S / P.C	PRICE / €
DE309I.AG	ancient grey / grigio antico	taupe / talpa	•	€ 589
DE305I.AG	ancient grey / grigio antico	black / nero		€ 589
DE304I.AG	ancient grey / grigio antico	mud grey / fango		€ 589
DE309I.BRO	bronze / bronzo	taupe / talpa		€ 589
DE304I.FA	mud grey / fango	mud grey / fango	•	€ 589
DE304I.BS	ivory white / bianco perla	mud grey / fango		€ 589

**DE15XI Barstool / Sgabello**

Stainless steel AISI 316 L / Acciaio inossidabile AISI 316 L

Weight / Peso : 8 Kgpackaging / imballo  1  0,37  12 CM L 104 P 61 H 58**Frame / Struttura**

CODE / CODICE	FRAME / STRUTTURA	ROPE / CORDA	Q.S / P.C	PRICE / €
DE159I.AG	ancient grey / grigio antico	taupe / talpa	•	€ 711
DE155I.AG	ancient grey / grigio antico	black / nero		€ 711
DE154I.AG	ancient grey / grigio antico	mud grey / fango		€ 711
DE159I.BRO	bronze / bronzo	taupe / talpa		€ 711
DE154I.FA	mud grey / fango	mud grey / fango	•	€ 711
DE154I.BS	ivory white / bianco perla	mud grey / fango		€ 711

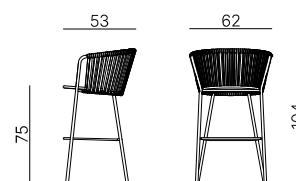
**CUSRM43 Seat cushion / Cuscino seduta (for / per DE30XI, DE15XI)**

Non-removable / Non sfoderabile

Anti-slip / Antiscivolo

With magnet / Con calamita

Washable / Lavabile

Waterproof gel-backing / Fodera impermeabile

Weight / Peso : 0,2 Kgpackaging / imballo  1  0,01  0,7 CM L 44 P 44 H 3**Cushion fabric set / Tessuti set cuscineria**

CODE / CODICE	BUSINESS	Q.S / P.C	PRICE	CODE / CODICE	SUNSET	Q.S / P.C	PRICE	CODE / CODICE	AVANT GARDE	Q.S / P.C	PRICE
CUSRM43.FOS	fossil	•	€ 45	CUSRM43.FRES	fresh		€ 54	CUSRM43.CSS	cream star		€ 54
CUSRM43.ECS	ecru		€ 45	CUSRM43.COPS	copper		€ 54	CUSRM43.FSS	mud grey star		€ 54
CUSRM43.TPS	taupe		€ 45	CUSRM43.PERS	pergamino		€ 54	CUSRM43.WSS	white star		€ 54
CUSRM43.BRS	brisa		€ 45	CUSRM43.ICES	ice		€ 54				
CUSRM43.GRS	grey		€ 45	CUSRM43.LIMS	limestone		€ 54				
CUSRM43.ANS	anthracite		€ 45								

Daisy Rope

DE60XI Lounge chair / Poltrona bassa

TOTAL PRICE WITH BUSINESS CUSHIONS / PREZZO TOTALE CON CUSCINI BUSINESS	€ 1.274
TOTAL PRICE WITH SUNSET CUSHIONS / PREZZO TOTALE CON CUSCINI SUNSET	€ 1.339
TOTAL PRICE WITH AVANT-GARDE CUSHIONS / PREZZO TOTALE CON CUSCINI AVANT-GARDE	€ 1.339



Stainless steel AISI 316 L / Acciaio inossidabile AISI 316 L

Seat and back cushion included / Cuscino seduta e schienale inclusi
Removable Cushions / Cuscini sfoderabili

Washable / Lavabile

Waterproof gel-backing / Fodera impermeabile

Weight / Peso : 14 Kg

packaging / imballo  1  0,49  17 CM L 83 P 76 H 77

Frame / Struttura

CODE / CODICE	FRAME / STRUTTURA	ROPE / CORDA	Q.S / P.C	PRICE / €
DE609I.AG	ancient grey / grigio antico	taupe / talpa	•	€ 1.038
DE605I.AG	ancient grey / grigio antico	black / nero		€ 1.038
DE604I.AG	ancient grey / grigio antico	mud grey / fango		€ 1.038
DE609I.BRO	bronze / bronzo	taupe / talpa		€ 1.038
DE604I.FA	mud grey / fango	mud grey / fango	•	€ 1.038
DE604I.BS	ivory white / bianco perla	mud grey / fango		€ 1.038

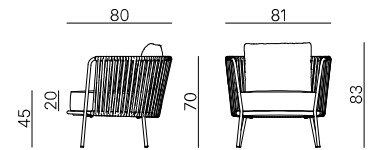

Cushion fabric set / Tessuti set cuscineria (1 seat cushion + 1 back cushion / 1 cuscino seduta + 1 cuscini schienale)

CODE / CODICE	BUSINESS	Q.S / P.C	PRICE	CODE / CODICE	SUNSET	Q.S / P.C	PRICE	CODE / CODICE	AVANT GARDE	Q.S / P.C	PRICE
DE600KIT.FOS	fossil	•	€ 236	DE600KIT.FRES	fresh		€ 301	DE600KIT.CSS	cream star		€ 301
DE600KIT.ECS	ecru		€ 236	DE600KIT.COPS	copper		€ 301	DE600KIT.FSS	mud grey star		€ 301
DE600KIT.TPS	taupe		€ 236	DE600KIT.PERS	pergamino		€ 301	DE600KIT.WSS	white star		€ 301
DE600KIT.BRS	brisa		€ 236	DE600KIT.ICES	ice		€ 301				
DE600KIT.GRS	grey	•	€ 236	DE600KIT.LIMS	limestone		€ 301				
DE600KIT.ANS	anthracite		€ 236								

DE63XI 2 seater sofa / Divano 2 posti

TOTAL PRICE WITH BUSINESS CUSHIONS / PREZZO TOTALE CON CUSCINI BUSINESS	€ 2.337
TOTAL PRICE WITH SUNSET CUSHIONS / PREZZO TOTALE CON CUSCINI SUNSET	€ 2.468
TOTAL PRICE WITH AVANT-GARDE CUSHIONS / PREZZO TOTALE CON CUSCINI AVANT-GARDE	€ 2.468



Stainless steel AISI 316 L / Acciaio inossidabile AISI 316 L

Seat and back cushions included / Cuscini seduta e schienale inclusi

Removable Cushions / Cuscini sfoderabili

Washable / Lavabile

Waterproof gel-backing / Fodera impermeabile

Weight / Peso : 31 Kgpackaging / imballo  1  1,04  36,5 CM L 167 P 81 H 77**Frame / Struttura**

CODE / CODICE	FRAME / STRUTTURA	ROPE / CORDA	Q.S / P.C	PRICE / €
DE639I.AG	ancient grey / grigio antico	taupe / talpa	•	€ 1.814
DE635I.AG	ancient grey / grigio antico	black / nero		€ 1.814
DE634I.AG	ancient grey / grigio antico	mud grey / fango		€ 1.814
DE639I.BRO	bronze / bronzo	taupe / talpa		€ 1.814
DE634I.FA	mud grey / fango	mud grey / fango	•	€ 1.814
DE634I.BS	ivory white / bianco perla	mud grey / fango		€ 1.814

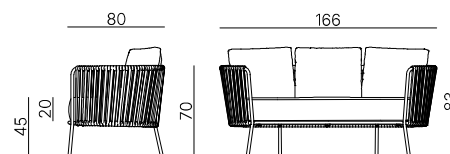
**Cushion fabric set / Tessuti set cuscineria (1 seat cushion + 3 back cushions / 1 cuscino seduta + 3 cuscini schienale)**

CODE / CODICE	BUSINESS	Q.S / P.C	PRICE	CODE / CODICE	SUNSET	Q.S / P.C	PRICE	CODE / CODICE	AVANT GARDE	Q.S / P.C	PRICE
DE630KIT.FOS	fossil	•	€ 523	DE630KIT.FRES	fresh		€ 654	DE630KIT.CSS	cream star		€ 654
DE630KIT.ECS	ecru		€ 523	DE630KIT.COPS	copper		€ 654	DE630KIT.FSS	mud grey star		€ 654
DE630KIT.TPS	taupe		€ 523	DE630KIT.PERS	pergamino		€ 654	DE630KIT.WSS	white star		€ 654
DE630KIT.BRS	brisa		€ 523	DE630KIT.ICES	ice		€ 654				
DE630KIT.GRS	grey		€ 523	DE630KIT.LIMS	limestone		€ 654				
DE630KIT.ANS	anthracite		€ 523								

Daisy Rope

DE73XI 3 seater sofa / Divano 3 posti

TOTAL PRICE WITH BUSINESS CUSHIONS / PREZZO TOTALE CON CUSCINI BUSINESS	€ 2.916
TOTAL PRICE WITH SUNSET CUSHIONS / PREZZO TOTALE CON CUSCINI SUNSET	€ 3.083
TOTAL PRICE WITH AVANT-GARDE CUSHIONS / PREZZO TOTALE CON CUSCINI AVANT-GARDE	€ 3.083

Stainless steel AISI 316 L / Acciaio inossidabile AISI 316 L



Seat and back cushion included / Cuscino seduta e schienale inclusi

Removable Cushions / Cuscini sfoderabili

Washable / Lavabile

Waterproof gel-backing / Fodera impermeabile

Weight / Peso : 40 Kg

packaging / imballo  1  1,2  51,5 CM L 220 P 78 H 74

Frame / Struttura

CODE / CODICE	FRAME / STRUTTURA	ROPE / CORDA	Q.S / P.C	PRICE / €
DE739I.AG	ancient grey / grigio antico	taupe / talpa		€ 2.226
DE735I.AG	ancient grey / grigio antico	black / nero		€ 2.226
DE734I.AG	ancient grey / grigio antico	mud grey / fango		€ 2.226
DE739I.BRO	bronze / bronzo	taupe / talpa		€ 2.226
DE734I.FA	mud grey / fango	mud grey / fango		€ 2.226
DE734I.BS	ivory white / bianco perla	mud grey / fango		€ 2.226

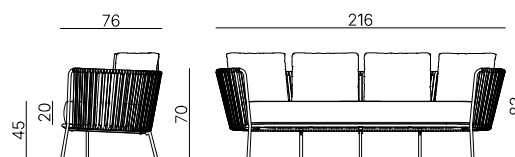

Cushion fabric set / Tessuti set cuscineria (1 seat cushion + 4 back cushion / 1 cuscino seduta + 4 cuscini schienale)

CODE / CODICE	BUSINESS	Q.S / P.C	PRICE	CODE / CODICE	SUNSET	Q.S / P.C	PRICE	CODE / CODICE	AVANT GARDE	Q.S / P.C	PRICE
DE730KIT.FOS	fossil		€ 690	DE730KIT.FRES	fresh		€ 857	DE730KIT.CSS	cream star		€ 857
DE730KIT.ECS	ecru		€ 690	DE730KIT.COPS	copper		€ 857	DE730KIT.FSS	mud grey star		€ 857
DE730KIT.TPS	taupe		€ 690	DE730KIT.PERS	pergamino		€ 857	DE730KIT.WSS	white star		€ 857
DE730KIT.BRS	brisa		€ 690	DE730KIT.ICES	ice		€ 857				
DE730KIT.GRS	grey		€ 690	DE730KIT.LIMS	limestone		€ 857				
DE730KIT.ANS	anthracite		€ 690								

DE70XI Maxi lounge chair / Poltrona maxi

TOTAL PRICE WITH BUSINESS CUSHIONS / PREZZO TOTALE CON CUSCINI BUSINESS € 2.022

TOTAL PRICE WITH SUNSET CUSHIONS / PREZZO TOTALE CON CUSCINI SUNSET € 2.227

TOTAL PRICE WITH AVANT-GARDE CUSHIONS / PREZZO TOTALE CON CUSCINI AVANT-GARDE € 2.227



Stainless steel AISI 316 L / Acciaio inossidabile AISI 316 L

Seat and back cushion included / Cuscino seduta e schienale inclusi

Removable Cushions / Cuscini sfoderabili

Washable / Lavabile

Waterproof gel-backing / Fodera impermeabile

Weight / Peso : 20 Kgpackaging / imballo  1  0,88  28 CM L 107 P 107 H 77**Frame / Struttura**

CODE / CODICE	FRAME / STRUTTURA	ROPE / CORDA	Q.S / P.C	PRICE / €
DE709I.AG	ancient grey / grigio antico	taupe / talpa		€ 1.470
DE705I.AG	ancient grey / grigio antico	black / nero		€ 1.470
DE704I.AG	ancient grey / grigio antico	mud grey / fango		€ 1.470
DE709I.BRO	bronze / bronzo	taupe / talpa		€ 1.470
DE704I.FA	mud grey / fango	mud grey / fango		€ 1.470
DE704I.BS	ivory white / bianco perla	mud grey / fango		€ 1.470

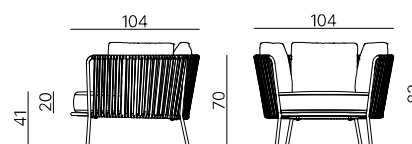
**Cushion fabric set / Tessuti set cuscineria (1 seat cushion + 3 back cushion / 1 cuscino seduta + 3 cuscini schienale)**

CODE / CODICE	BUSINESS	Q.S / P.C	PRICE	CODE / CODICE	SUNSET	Q.S / P.C	PRICE	CODE / CODICE	AVANT GARDE	Q.S / P.C	PRICE
DE700KIT.FOS	fossil		€ 552	DE700KIT.FRES	fresh		€ 757	DE700KIT.CSS	cream star		€ 757
DE700KIT.ECS	ecru		€ 552	DE700KIT.COPS	copper		€ 757	DE700KIT.FSS	mud grey star		€ 757
DE700KIT.TPS	taupe		€ 552	DE700KIT.PERS	pergamino		€ 757	DE700KIT.WSS	white star		€ 757
DE700KIT.BRS	brisa		€ 552	DE700KIT.ICES	ice		€ 757				
DE700KIT.GRS	grey		€ 552	DE700KIT.LIMS	limestone		€ 757				
DE700KIT.ANS	anthracite		€ 552								

Daisy Rope

DE290I Pouf

TOTAL PRICE WITH BUSINESS CUSHIONS / PREZZO TOTALE CON CUSCINI BUSINESS € 641

TOTAL PRICE WITH SUNSET CUSHIONS / PREZZO TOTALE CON CUSCINI SUNSET € 693

TOTAL PRICE WITH AVANT-GARDE CUSHIONS / PREZZO TOTALE CON CUSCINI AVANT-GARDE € 693

Stainless steel AISI 316 L / Acciaio inossidabile AISI 316 L



Seat cushion included / Cuscino seduta incluso

Removable Cushions / Cuscini sfoderabili

Washable / Lavabile

Waterproof gel-backing / Fodera impermeabile

Weight / Peso : 10 Kg

packaging / imballo  1  0,18  13 CM L 70 P 70 H 35

Frame / Struttura

CODE / CODICE	FRAME / STRUTTURA	Q.S / P.C	PRICE / €
DE290I.AG	ancient grey / grigio antico		€ 467
DE290I.BRO	bronze / bronzo		€ 467
DE290I.FA	mud grey / fango		€ 467
DE290I.BS	ivory white / bianco perla		€ 467

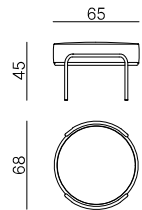

Cushion fabric set / Tessuti set cuscineria (1 seat cushion / 1 cuscino seduta)

CODE / CODICE	BUSINESS	Q.S / P.C	PRICE	CODE / CODICE	SUNSET	Q.S / P.C	PRICE	CODE / CODICE	AVANT GARDE	Q.S / P.C	PRICE
CUSDE600.FOS	fossil		€ 174	CUSDE600.FRES	fresh		€ 226	CUSDE600.CSS	cream star		€ 226
CUSDE600.ECS	ecru		€ 174	CUSDE600.COPS	copper		€ 226	CUSDE600.FSS	mud grey star		€ 226
CUSDE600.TPS	taupe		€ 174	CUSDE600.PERS	pergamino		€ 226	CUSDE600.WSS	white star		€ 226
CUSDE600.BRS	brisa		€ 174	CUSDE600.ICES	ice		€ 226				
CUSDE600.GRS	grey		€ 174	CUSDE600.LIMS	limestone		€ 226				
CUSDE600.ANS	anthracite		€ 174								

DE29XI Pouf - coffee table / Pouf - tavolo basso

TOTAL PRICE WITH BUSINESS CUSHIONS / PREZZO TOTALE CON CUSCINI BUSINESS	€ 1.476
TOTAL PRICE WITH SUNSET CUSHIONS / PREZZO TOTALE CON CUSCINI SUNSET	€ 1.623
TOTAL PRICE WITH AVANT-GARDE CUSHIONS / PREZZO TOTALE CON CUSCINI AVANT-GARDE	€ 1.623



Stainless steel AISI 316 L / Acciaio inossidabile AISI 316 L

Seat cushion included / Cuscino seduta incluso

Removable Cushion / Cuscino sfoderabile

Washable / Lavabile

Waterproof gel-backing / Fodera impermeabile

Weight / Peso : 18,5 Kgpackaging / imballo  1  0,46  23 CM L 97 P 97 H 49**Frame / Struttura**

CODE / CODICE	FRAME / STRUTTURA	ROPE / CORDA	Q.S / P.C	PRICE / €
DE299I.AG	ancient grey / grigio antico	taupe / talpa		€ 1.240
DE295I.AG	ancient grey / grigio antico	black / nero		€ 1.240
DE294I.AG	ancient grey / grigio antico	mud grey / fango		€ 1.240
DE299I.BRO	bronze / bronzo	taupe / talpa		€ 1.240
DE294I.FA	mud grey / fango	mud grey / fango		€ 1.240
DE294I.BS	ivory white / bianco perla	mud grey / fango		€ 1.240

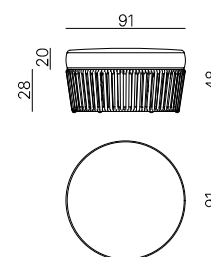
**Cushion fabric set / Tessuti set cuscineria (1 seat cushion / 1 cuscino seduta)**

CODE / CODICE	BUSINESS	Q.S / P.C	PRICE	CODE / CODICE	SUNSET	Q.S / P.C	PRICE	CODE / CODICE	AVANT GARDE	Q.S / P.C	PRICE
CUSDE704.FOS	fossil		€ 236	CUSDE704.FRES	fresh		€ 383	CUSDE704.CSS	cream star		€ 383
CUSDE704.ECS	ecru		€ 236	CUSDE704.COPS	copper		€ 383	CUSDE704.FSS	mud grey star		€ 383
CUSDE704.TPS	taupe		€ 236	CUSDE704.PERS	pergamino		€ 383	CUSDE704.WSS	white star		€ 383
CUSDE704.BRS	brisa		€ 236	CUSDE704.ICES	ice		€ 383				
CUSDE704.GRS	grey		€ 236	CUSDE704.LIMS	limestone		€ 383				
CUSDE704.ANS	anthracite		€ 236								

Daisy Rope

DE501XI 1 Seater porch swing / Altalena 1 posto

TOTAL PRICE WITH BUSINESS CUSHIONS / PREZZO TOTALE CON CUSCINI BUSINESS	€ 1.486
TOTAL PRICE WITH SUNSET CUSHIONS / PREZZO TOTALE CON CUSCINI SUNSET	€ 1.551
TOTAL PRICE WITH AVANT-GARDE CUSHIONS / PREZZO TOTALE CON CUSCINI AVANT-GARDE	€ 1.551

Stainless steel AISI 316 L / Acciaio inossidabile AISI 316 L



Seat and back cushion included / Cuscino seduta e schienale inclusi

Removable Cushions / Cuscini sfoderabili

Washable / Lavabile

Waterproof gel-backing / Fodera impermeabile

Weight / Peso : 12 Kg

packaging / imballo  1  0,49  17 CM L 83 P 75 H 78

Frame / Struttura

CODE / CODICE	FRAME / STRUTTURA	ROPE / CORDA	Q.S / P.C	PRICE / €
DE5019I.AG	ancient grey / grigio antico	taupe / talpa		€ 1.250
DE5015I.AG	ancient grey / grigio antico	black / nero		€ 1.250
DE5014I.AG	ancient grey / grigio antico	mud grey / fango		€ 1.250
DE5019I.BRO	bronze / bronzo	taupe / talpa		€ 1.250
DE5014I.FA	mud grey / fango	mud grey / fango		€ 1.250
DE5014I.BS	ivory white / bianco perla	mud grey / fango		€ 1.250

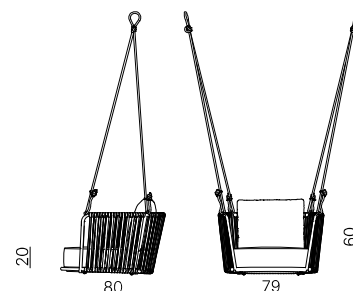

Cushion fabric set / Tessuti set cuscineria (1 seat cushion + 1 back cushion / 1 cuscino seduta + 1 cuscini schienale)

CODE / CODICE	BUSINESS	Q.S / P.C	PRICE	CODE / CODICE	SUNSET	Q.S / P.C	PRICE	CODE / CODICE	AVANT GARDE	Q.S / P.C	PRICE
DE600KIT.FOS	fossil		€ 236	DE600KIT.FRES	fresh		€ 301	DE600KIT.CSS	cream star		€ 301
DE600KIT.ECS	ecru		€ 236	DE600KIT.COPS	copper		€ 301	DE600KIT.FSS	mud grey star		€ 301
DE600KIT.TPS	taupe		€ 236	DE600KIT.PERS	pergamino		€ 301	DE600KIT.WSS	white star		€ 301
DE600KIT.BRS	brisa		€ 236	DE600KIT.ICES	ice		€ 301				
DE600KIT.GRS	grey		€ 236	DE600KIT.LIMS	limestone		€ 301				
DE600KIT.ANS	anthracite		€ 236								

DE502XI 2 Seater porch swing / Altalena 2 posti

TOTAL PRICE WITH BUSINESS CUSHIONS / PREZZO TOTALE CON CUSCINI BUSINESS € 2.462

TOTAL PRICE WITH SUNSET CUSHIONS / PREZZO TOTALE CON CUSCINI SUNSET € 2.593

TOTAL PRICE WITH AVANT-GARDE CUSHIONS / PREZZO TOTALE CON CUSCINI AVANT-GARDE € 2.593



Stainless steel AISI 316 L / Acciaio inossidabile AISI 316 L

Seat and back cushion included / Cuscino seduta e schienale inclusi

Removable Cushions / Cuscini sfoderabili

Washable / Lavabile

Waterproof gel-backing / Fodera impermeabile

Weight / Peso : 31 Kgpackaging / imballo  1  0,69  37 CM L 165 P 81 H 52**Frame / Struttura**

CODE / CODICE	FRAME / STRUTTURA	ROPE / CORDA	Q.S / P.C	PRICE / €
DE5029I.AG	ancient grey / grigio antico	taupe / talpa		€ 1.939
DE5025I.AG	ancient grey / grigio antico	black / nero		€ 1.939
DE5024I.AG	ancient grey / grigio antico	mud grey / fango		€ 1.939
DE5029I.BRO	bronze / bronzo	taupe / talpa		€ 1.939
DE5024I.FA	mud grey / fango	mud grey / fango		€ 1.939
DE5024I.BS	ivory white / bianco perla	mud grey / fango		€ 1.939

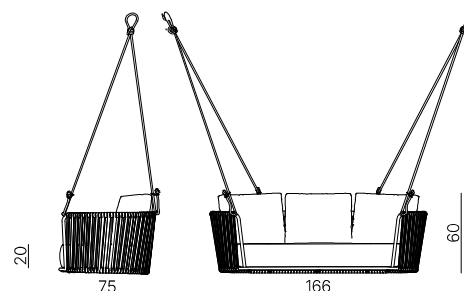
**Cushion fabric set / Tessuti set cuscineria (1 seat cushion + 3 back cushion / 1 cuscino seduta + 3 cuscini schienale)**

CODE / CODICE	BUSINESS	Q.S / P.C	PRICE	CODE / CODICE	SUNSET	Q.S / P.C	PRICE	CODE / CODICE	AVANT GARDE	Q.S / P.C	PRICE
DE630KIT.FOS	fossil		€ 523	DE630KIT.FRES	fresh		€ 654	DE630KIT.CSS	cream star		€ 654
DE630KIT.ECS	ecru		€ 523	DE630KIT.COPS	copper		€ 654	DE630KIT.FSS	mud grey star		€ 654
DE630KIT.TPS	taupe		€ 523	DE630KIT.PERS	pergamino		€ 654	DE630KIT.WSS	white star		€ 654
DE630KIT.BRS	brisa		€ 523	DE630KIT.ICES	ice		€ 654				
DE630KIT.GRS	grey		€ 523	DE630KIT.LIMS	limestone		€ 654				
DE630KIT.ANS	anthracite		€ 523								

Emma

Designed by Vermobil Team



frame / struttura

standard colours / colori standard



back and seat batyline / batyline seduta e schienale

basic

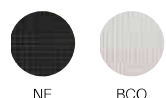

eden

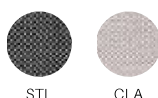

EA310 Armchair / Poltrona

Aluminium / Alluminio

Batyline fabric / Tessuto Batyline

Stackable / Impilabile (6 pcs)

Weight / Peso : 4 Kg

packaging / imballo  4  0,45  19 CM L 100 P 71 H 63

Frame / Struttura

CODE / CODICE	FRAME / STRUTTURA	BATYLINE	O.S / P.C	PRICE / €
EA310.AG/NE	ancient grey / grigio antico	black / nero		€ 217
EA310.BS/BCO	ivory white / bianco perla	white / bianco	•	€ 217
EA310.AG/STL	ancient grey / grigio antico	steel		€ 241
EA310.BS/CLA	ivory white / bianco perla	clay	•	€ 241

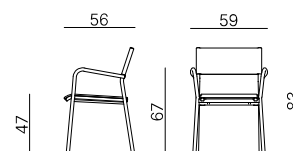

More information on colors and fabrics from page 194 / Più informazioni su colori e tessuti da pagina 194

Extia

Designed by Vermobil Team



frame / struttura

standard colours / colori standard



EX14080 Extendable table / Tavolo allungabile 140/200x80

Galvanized steel / Acciaio zincato
Extension / Prolunga 60cm
Knockdown / Smontabile

Leveling / Autolivellante
Weight / Peso : 45 Kg

packaging / imballo 1 0,29 60 CM L 160 P 90 H 20

Frame / Struttura

CODE / CODICE	FRAME / STRUTTURA	Q.S / P.C	PRICE / €
EX14080.AG	ancient grey / grigio antico	•	€ 1.168
EX14080.BRO	bronze / bronzo		€ 1.168
EX14080.FA	mud grey / fango		€ 1.168
EX14080.BCU	matt white / bianco goffrato		€ 1.168
EX14080.BS	ivory white / bianco perla		€ 1.168

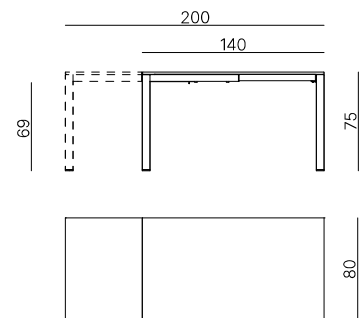

EX18090 Extendable table / Tavolo allungabile 180/250x90

Galvanized steel / Acciaio zincato
Extension / Prolunga 70cm
Knockdown / Smontabile

Leveling / Autolivellante
Weight / Peso : 65 Kg

packaging / imballo 1 0,40 85 CM L 200 P 100 H 20

Frame / Struttura

CODE / CODICE	FRAME / STRUTTURA	Q.S / P.C	PRICE / €
EX18090.AG	ancient grey / grigio antico	•	€ 1.285
EX18090.BRO	bronze / bronzo		€ 1.285
EX18090.FA	mud grey / fango		€ 1.285
EX18090.BCU	matt white / bianco goffrato		€ 1.285
EX18090.BS	ivory white / bianco perla		€ 1.285

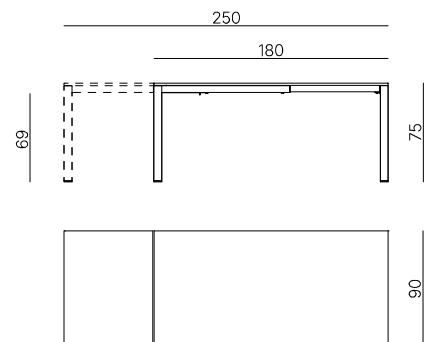

Fellini

Designed by Vermobil Team



frame / struttura

standard colours / colori standard



back and seat batyline / batyline seduta e schienale

eden

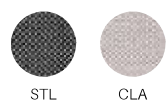

FE30X Armchair / Poltrona

Aluminium / Alluminio
Foldable / Pieghevole

Batyline fabric / Tessuto Batyline
Weight / Peso : 4 Kg

packaging / imballo 1 0,16 8 CM L 105 P 23 H 68

Frame / Struttura

CODE / CODICE	FRAME / STRUTTURA	ROPE / CORDA	BATYLINE	Q.S / P.C	PRICE / €
FE305.AG/STL	ancient grey / grigio antico	black / nero	steel		€ 462
FE304.BS/CLA	ivory white / bianco perla	mud grey / fango	clay		€ 462

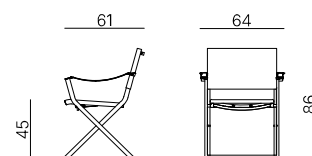

Firenze

Designed by Vermobil Team



frame / struttura

standard colours / colori standard



AG

Texplast



BL413 Sunbed / Lettino

Aluminium / Alluminio
Texplast

Stackable / Impilabile (10 pcs)
Weight / Peso : 9,5

packaging / imballo 18 3,45 200 CM L 196 P 80 H 220

Frame / Struttura

CODE / CODICE	FRAME / STRUTTURA	BATYLINE	Q.S / P.C	PRICE / €
BL413.AG/AG	ancient grey / grigio antico	anthracite	•	€ 369

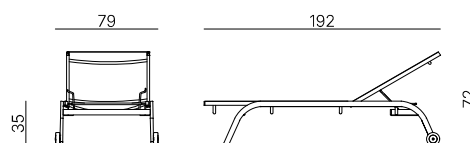

Flora

Designed by Vermobil Team

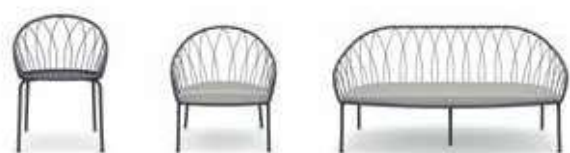

frame / struttura

standard colours / colori standard

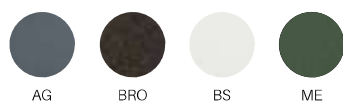

fabrics / tessuti

business

sunset

avant-garde



FA300 Armchair / Poltrona

Galvanized steel / Acciaio zincato

Stackable / Impilabile (2 pcs)

Weight / Peso : 7 Kg

packaging / imballo 2 0,38 17 CM L 98 P 65 H 60

Frame / Struttura

CODE / CODICE	FRAME / STRUTTURA	Q.S / P.C	PRICE / €
FA300.AG	ancient grey / grigio antico	•	€ 232
FA300.BRO	bronze / bronzo		€ 232
FA300.BS	ivory white / bianco perla		€ 232
FA300.ME	mint green / menta		€ 232

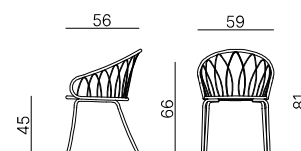

CUSFA300 Seat cushion / Cuscino seduta (for / per FA300)

Non-removable / Non sfoderabile

Anti-slip / Antiscivolo

With magnet / Con calamita

Washable / Lavabile

Waterproof gel-backing / Fodera impermeabile

Weight / Peso : 0,2 Kg

packaging / imballo 1 0,01 0,5 CM L 48 P 45 H 4

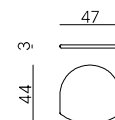

Cushion fabric set / Tessuti set cuscineria

CODE / CODICE	BUSINESS	Q.S / P.C	PRICE	CODE / CODICE	SUNSET	Q.S / P.C	PRICE	CODE / CODICE	AVANT GARDE	Q.S / P.C	PRICE
CUSFA300.FOS	fossil	•	€ 61	CUSFA300.FRES	fresh		€ 66	CUSFA300.FSS	mud grey star		€ 66
				CUSFA300.PERS	pergamino		€ 66				
				CUSFA300.LIMS	limestone		€ 66				



FA600 Lounge chair / Poltrona bassa

TOTAL PRICE WITH BUSINESS CUSHIONS / PREZZO TOTALE CON CUSCINI BUSINESS € 745

TOTAL PRICE WITH SUNSET CUSHIONS / PREZZO TOTALE CON CUSCINI SUNSET € 821

TOTAL PRICE WITH AVANT-GARDE CUSHIONS / PREZZO TOTALE CON CUSCINI AVANT-GARDE € 821

Galvanized steel / Acciaio zincato Washable / Lavabile
 Elastic strap seat / Seduta in cinta elastica Waterproof gel-backing / Fodera impermeabile
 Seat cushion included / Cuscino seduta incluso **Weight / Peso : 9Kg**
 Removable Cushions / Cuscini sfoderabili

packaging / imballo  1  0,61  14 CM L 86 P 81 H 87

Frame / Struttura

CODE / CODICE	FRAME / STRUTTURA	Q.S / P.C	PRICE / €
FA600.AG	ancient grey / grigio antico	•	€ 573
FA600.BRO	bronze / bronzo		€ 573
FA600.BS	ivory white / bianco perla		€ 573
FA600.ME	mint green / menta		€ 573

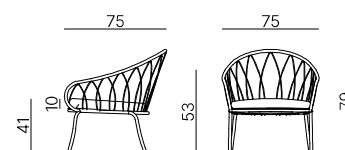

Cushion fabric set / Tessuti set cuscineria (1 seat cushion / 1 cuscino seduta)

CODE / CODICE	BUSINESS	Q.S / P.C	PRICE	CODE / CODICE	SUNSET	Q.S / P.C	PRICE	CODE / CODICE	AVANT GARDE	Q.S / P.C	PRICE
CUSFA600.FOS	fossil	•	€ 172	CUSFA600.FRES	fresh		€ 248	CUSFA600.FSS	mud grey star		€ 248
				CUSFA600.PERS	pergamino		€ 248				
				CUSFA600.LIMS	limestone		€ 248				

FA630 2 seater sofa / Divano 2 posti

TOTAL PRICE WITH BUSINESS CUSHIONS / PREZZO TOTALE CON CUSCINI BUSINESS € 1.412

TOTAL PRICE WITH SUNSET CUSHIONS / PREZZO TOTALE CON CUSCINI SUNSET € 1.555

TOTAL PRICE WITH AVANT-GARDE CUSHIONS / PREZZO TOTALE CON CUSCINI AVANT-GARDE € 1.555

Galvanized steel / Acciaio zincato Washable / Lavabile
 Elastic strap seat / Seduta in cinta elastica Waterproof gel-backing / Fodera impermeabile
 Seat cushion included / Cuscino seduta incluso **Weight / Peso : 17Kg**
 Removable Cushions / Cuscini sfoderabili

packaging / imballo  1  1,11  22 CM L 162 P 79 H 87

Frame / Struttura

CODE / CODICE	FRAME / STRUTTURA	Q.S / P.C	PRICE / €
FA630.AG	ancient grey / grigio antico	•	€ 1.114
FA630.BRO	bronze / bronzo		€ 1.114
FA630.BS	ivory white / bianco perla		€ 1.114
FA630.ME	mint green / menta		€ 1.114

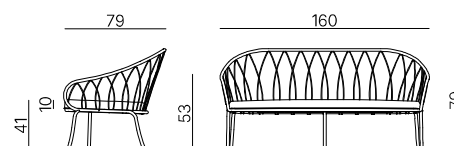

Cushion fabric set / Tessuti set cuscineria (1 seat cushion / 1 cuscino seduta)

CODE / CODICE	BUSINESS	Q.S / P.C	PRICE	CODE / CODICE	SUNSET	Q.S / P.C	PRICE	CODE / CODICE	AVANT GARDE	Q.S / P.C	PRICE
CUSFA630.FOS	fossil	•	€ 298	CUSFA630.FRES	fresh		€ 441	CUSFA630.FSS	mud grey star		€ 441
				CUSFA630.PERS	pergamino		€ 441				
				CUSFA630.LIMS	limestone		€ 441				

Fox

Designed by Vermobil Team



frame / struttura

standard colours / colori standard

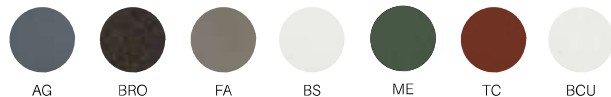

AG BRO FA BS ME TC BCU

fabrics / tessuti

business





ANS BRS ECS FOS GRS TPS

More information on colors and fabrics from page 194 / Più informazioni su colori e tessuti da pagina 194

FO100 Chair / Sedia

Galvanized steel / Acciaio zincato
Stackable / Impilabile (4 pcs)

Weight / Peso : 5 Kg

packaging / imballo  4  0,29  23 CM L 94 P 61 H 50

Frame / Struttura

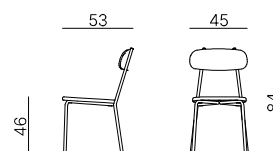

CODE / CODICE	FRAME / STRUTTURA	Q.S / P.C	PRICE / €
FO100.AG	ancient grey / grigio antico	•	€ 107
FO100.BRO	bronze / bronzo	•	€ 107
FO100.FA	mud grey / fango	•	€ 107
FO100.BS	ivory white / bianco perla	•	€ 107
FO100.ME	mint green / menta		€ 107
FO100.TC	terracotta / terracotta		€ 107
FO100.BCU	matt white / bianco goffrato		€ 107



FO300 Armchair / Poltrona

Galvanized steel / Acciaio zincato
Stackable / Impilabile (4 pcs)

Weight / Peso : 6 Kg

packaging / imballo  4  0,39  27 CM L 100 P 67 H 58

Frame / Struttura

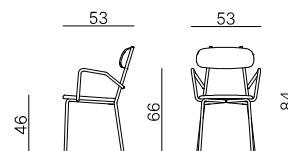

CODE / CODICE	FRAME / STRUTTURA	Q.S / P.C	PRICE / €
FO300.AG	ancient grey / grigio antico	•	€ 117
FO300.BRO	bronze / bronzo	•	€ 117
FO300.FA	mud grey / fango	•	€ 117
FO300.BS	ivory white / bianco perla	•	€ 117
FO300.ME	mint green / menta		€ 117
FO300.TC	terracotta / terracotta		€ 117
FO300.BCU	matt white / bianco goffrato		€ 117



FO150 Barstool / Sgabello

Galvanized steel / Acciaio zincato
Stackable / Impilabile (4 pcs)

Weight / Peso : 7 Kg

packaging / imballo  1  0,31  10 CM L 104 P 58 H 52

Frame / Struttura

CODE / CODICE	FRAME / STRUTTURA	Q.S / P.C	PRICE / €
FO150.AG	ancient grey / grigio antico	•	€ 189
FO150.BRO	bronze / bronzo	•	€ 189
FO150.FA	mud grey / fango	•	€ 189
FO150.BS	ivory white / bianco perla	•	€ 189
FO150.ME	mint green / menta		€ 189
FO150.TC	terracotta / terracotta		€ 189
FO150.BCU	matt white / bianco goffrato		€ 189

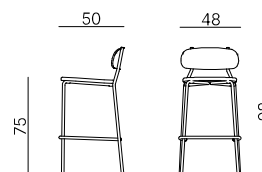

Fox

CUSF0100 Seat cushion / Cuscino seduta (for / per FO100, FO300, FO150)

Non-removable / Non sfoderabile

Anti-slip / Antiscivolo

With magnet / Con calamita

Washable / Lavabile

Waterproof gel-backing / Fodera impermeabile

Weight / Peso : 0,2 Kg

packaging / imballo  1  0,01  0,4 CM L 42 P 39 H 3

Cushion fabric set / Tessuti set cuscineria

CODE / CODICE	BUSINESS	Q.S / P.C	PRICE
CUSF0100.FOS	fossil	•	€ 45
CUSF0100.ECS	ecru		€ 45
CUSF0100.TPS	taupe		€ 45
CUSF0100.BRS	brisa		€ 45
CUSF0100.GRS	grey		€ 45
CUSF0100.ANS	anthracite		€ 45

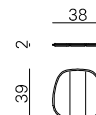







FO6060 Table / Tavolo 60x60

Galvanized steel / Acciaio zincato

Self-leveling / Autolivellante

Stackable / Impilabile (8 pcs)

Weight / Peso : 11 Kg

packaging / imballo  8  1  94 CM L 90 P 90 H 124  16  1,78  182 CM L 90 P 90 H 188

Frame / Struttura

CODE / CODICE	FRAME / STRUTTURA	Q.S / P.C	PRICE / €
FO6060.AG	ancient grey / grigio antico	•	€ 198
FO6060.BRO	bronze / bronzo	•	€ 198
FO6060.FA	mud grey / fango	•	€ 198
FO6060.BS	ivory white / bianco perla	•	€ 198
FO6060.ME	mint green / menta		€ 198
FO6060.TC	terracotta / terracotta		€ 198
FO6060.BCU	matt white / bianco goffrato		€ 198

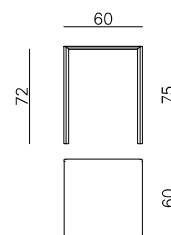

FO6060H High table / Tavolo 60x60xH110

Galvanized steel / Acciaio zincato

Self-leveling / Autolivellante

Stackable / Impilabile (8 pcs)

Weight / Peso : 13,5 Kg

packaging / imballo  8  1,34  116 CM L 90 P 90 H 155

Frame / Struttura



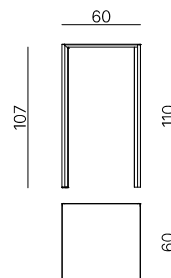



CODE / CODICE	FRAME / STRUTTURA	Q.S / P.C	PRICE / €
FO6060H.AG	ancient grey / grigio antico	•	€ 225
FO6060H.BRO	bronze / bronzo	•	€ 225
FO6060H.FA	mud grey / fango	•	€ 225
FO6060H.BS	ivory white / bianco perla	•	€ 225
FO6060H.ME	mint green / menta		€ 225
FO6060H.TC	terracotta / terracotta		€ 225
FO6060H.BCU	matt white / bianco goffrato		€ 225



FO7070 Table / Tavolo 70×70

Galvanized steel / Acciaio zincato
Self-leveling / Autolivellante

Stackable / Impilabile (8 pcs)
Weight / Peso : 12 Kg

packaging / imballo  8  1,3  112 CM L106 P106 H120  16  2,11  208 CM L106 P106 H188

Frame / Struttura



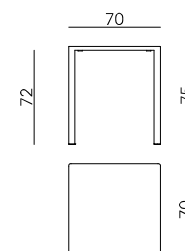



CODE / CODICE	FRAME / STRUTTURA	Q.S / P.C	PRICE / €
FO7070.AG	ancient grey / grigio antico	•	€ 211
FO7070.BRO	bronze / bronzo	•	€ 211
FO7070.FA	mud grey / fango	•	€ 211
FO7070.BS	ivory white / bianco perla	•	€ 211
FO7070.ME	mint green / menta		€ 211
FO7070.TC	terracotta / terracotta		€ 211
FO7070.BCU	matt white / bianco goffrato		€ 211



FO8080 Table / Tavolo 80×80

Galvanized steel / Acciaio zincato
Self-leveling / Autolivellante

Stackable / Impilabile (8 pcs)
Weight / Peso : 14 Kg

packaging / imballo  8  1,39  130 CM L118 P118 H120  16  2,62  242 CM L118 P118 H188

Frame / Struttura



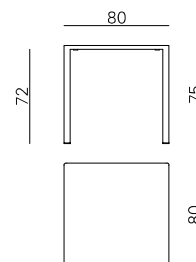



CODE / CODICE	FRAME / STRUTTURA	Q.S / P.C	PRICE / €
FO8080.AG	ancient grey / grigio antico	•	€ 218
FO8080.BRO	bronze / bronzo	•	€ 218
FO8080.FA	mud grey / fango	•	€ 218
FO8080.BS	ivory white / bianco perla	•	€ 218
FO8080.ME	mint green / menta		€ 218
FO8080.TC	terracotta / terracotta		€ 218
FO8080.BCU	matt white / bianco goffrato		€ 218



FO9090 Table / Tavolo 90×90

Galvanized steel / Acciaio zincato
Self-leveling / Autolivellante

Stackable / Impilabile (8 pcs)
Weight / Peso : 20 Kg

packaging / imballo  8  2,03  198 CM L128 P128 H124  16  2,66  346 CM L128 P128 H188

Frame / Struttura

CODE / CODICE	FRAME / STRUTTURA	Q.S / P.C	PRICE / €
FO9090.AG	ancient grey / grigio antico	•	€ 293
FO9090.BRO	bronze / bronzo	•	€ 293
FO9090.FA	mud grey / fango	•	€ 293
FO9090.BS	ivory white / bianco perla	•	€ 293
FO9090.ME	mint green / menta		€ 293
FO9090.TC	terracotta / terracotta		€ 293
FO9090.BCU	matt white / bianco goffrato		€ 293

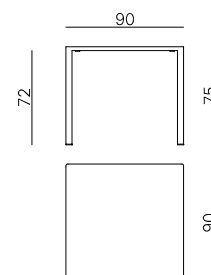



Fox

FO14090 Table / Tavolo 140×90

Galvanized steel / Acciaio zincato
Self-leveling / Autolivellante

Knockdown / Smontabile
Weight / Peso : 28 Kg

packaging / imballo  1  0,19  35 CM L 125 P 16 H 96

Frame / Struttura

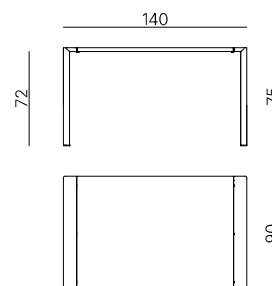

CODE / CODICE	FRAME / STRUTTURA	Q.S / P.C	PRICE / €
FO14090.AG	ancient grey / grigio antico	•	€ 642
FO14090.BRO	bronze / bronzo		€ 642
FO14090.FA	mud grey / fango		€ 642
FO14090.BS	ivory white / bianco perla	•	€ 642
FO14090.ME	mint green / menta		€ 642
FO14090.TC	terracotta / terracotta		€ 642
FO14090.BCU	matt white / bianco goffrato		€ 642



FO20090 Table / Tavolo 200×90

Galvanized steel / Acciaio zincato
Self-leveling / Autolivellante

Knockdown / Smontabile
Weight / Peso : 39 Kg

packaging / imballo  1  0,30  45 CM L 185 P 17 H 96

Frame / Struttura

CODE / CODICE	FRAME / STRUTTURA	Q.S / P.C	PRICE / €
FO20090.AG	ancient grey / grigio antico	•	€ 740
FO20090.BRO	bronze / bronzo		€ 740
FO20090.FA	mud grey / fango		€ 740
FO20090.BS	ivory white / bianco perla	•	€ 740
FO20090.ME	mint green / menta		€ 740
FO20090.TC	terracotta / terracotta		€ 740
FO20090.BCU	matt white / bianco goffrato		€ 740

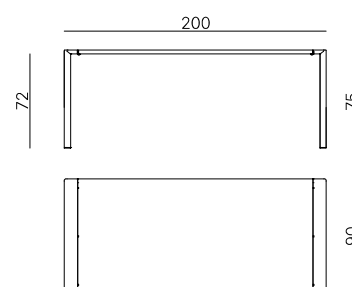



Hamptons

Designed by Vermobil Team



frame / struttura

standard colours / colori standard

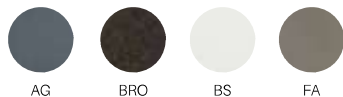

fabrics / tessuti

business



sunset



avant-garde



Pillow Pag. 174

More information on colors and fabrics from page 194 / Più informazioni su colori e tessuti da pagina 194

HA669 Lounge chair / Poltrona bassa

TOTAL PRICE WITH BUSINESS CUSHIONS / PREZZO TOTALE CON CUSCINI BUSINESS € 1.894

TOTAL PRICE WITH SUNSET CUSHIONS / PREZZO TOTALE CON CUSCINI SUNSET € 1.973

TOTAL PRICE WITH AVANT-GARDE CUSHIONS / PREZZO TOTALE CON CUSCINI AVANT-GARDE € 1.973

Galvanized steel / Acciaio zincato



Elastic strap seat / Seduta in cinta elastica

Seat and back cushion included / Cuscino seduta e schienale inclusi

Removable Cushions / Cuscini sfoderabili

Washable / Lavabile

Waterproof gel-backing / Fodera impermeabile

Weight / Peso : 20 Kgpackaging / imballo  1  0,5  23 CM L 86 P 86 H 68**Frame / Struttura**

CODE / CODICE	FRAME / STRUTTURA	ROPE / CORDA	Q.S / P.C	PRICE / €
HA669.AG	ancient grey / grigio antico	taupe / talpa	•	€ 1.634
HA669.BRO	bronze / bronzo	taupe / talpa		€ 1.634
HA669.BS	ivory white / bianco perla	taupe / talpa		€ 1.634
HA669.FA	grey mud / fango	taupe / talpa		€ 1.634

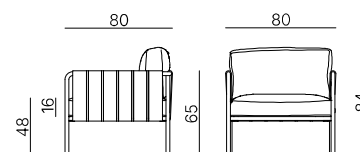
**Cushion fabric set / Tessuti set cuscineria (1 seat cushion + 1 back cushion / 1 cuscino seduta + 1 cuscini schienale)**

CODE / CODICE	BUSINESS	Q.S / P.C	PRICE	CODE / CODICE	SUNSET	Q.S / P.C	PRICE	CODE / CODICE	AVANT GARDE	Q.S / P.C	PRICE
KW600KIT.FOS	fossil	•	€ 260	KW600KIT.PERS	pergamino		€ 339	KW600KIT.CSS	cream star		€ 339
KW600KIT.ANS	anthracite		€ 260	KW600KIT.LIMS	limestone		€ 339				
KW600KIT.TPS	taupe		€ 260								
KW600KIT.GRS	grey		€ 260								

Hamptons

HA609 Single seat module / Modulo singolo

TOTAL PRICE WITH BUSINESS CUSHIONS / PREZZO TOTALE CON CUSCINI BUSINESS	€ 1.138
TOTAL PRICE WITH SUNSET CUSHIONS / PREZZO TOTALE CON CUSCINI SUNSET	€ 1.217
TOTAL PRICE WITH AVANT-GARDE CUSHIONS / PREZZO TOTALE CON CUSCINI AVANT-GARDE	€ 1.217

Galvanized steel / Acciaio zincato
Elastic strap seat / Seduta in cinta elastica
Seat and back cushion included / Cuscino seduta e schienale inclusi
Removable Cushions / Cuscini sfoderabili

Washable / Lavabile
Waterproof gel-backing / Fodera impermeabile
Weight / Peso : 16 Kg

packaging / imballo  1  0,5  19 CM L 86 P 86 H 68

Frame / Struttura

CODE / CODICE	FRAME / STRUTTURA	ROPE / CORDA	Q.S / P.C	PRICE / €
HA609.AG	ancient grey / grigio antico	taupe / talpa	•	€ 878
HA609.BRO	bronze / bronzo	taupe / talpa		€ 878
HA609.BS	ivory white / bianco perla	taupe / talpa		€ 878
HA609.FA	grey mud / fango	taupe / talpa		€ 878

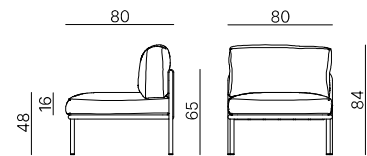

Cushion fabric set / Tessuti set cuscineria (1 seat cushion + 1 back cushion / 1 cuscino seduta + 1 cuscini schienale)



CODE / CODICE	BUSINESS	Q.S / P.C	PRICE	CODE / CODICE	SUNSET	Q.S / P.C	PRICE	CODE / CODICE	AVANT GARDE	Q.S / P.C	PRICE
KW600KIT.FOS	fossil	•	€ 260	KW600KIT.PERS	pergamino		€ 339	KW600KIT.CSS	cream star		€ 339
KW600KIT.ANS	anthracite		€ 260	KW600KIT.LIMS	limestone		€ 339				
KW600KIT.TPS	taupe		€ 260								
KW600KIT.GRS	grey		€ 260								

HA639 Corner module / Modulo angolo

TOTAL PRICE WITH BUSINESS CUSHIONS / PREZZO TOTALE CON CUSCINI BUSINESS	€ 1.503
TOTAL PRICE WITH SUNSET CUSHIONS / PREZZO TOTALE CON CUSCINI SUNSET	€ 1.582
TOTAL PRICE WITH AVANT-GARDE CUSHIONS / PREZZO TOTALE CON CUSCINI AVANT-GARDE	€ 1.582

Galvanized steel / Acciaio zincato
Elastic strap seat / Seduta in cinta elastica
Seat and back cushion included / Cuscino seduta e schienale inclusi
Corner cushion not included / Cuscino angolare non incluso

Removable Cushions / Cuscini sfoderabili
Washable / Lavabile
Waterproof gel-backing / Fodera impermeabile
Weight / Peso : 18 Kg

packaging / imballo  1  0,5  21 CM L 86 P 86 H 68

Frame / Struttura

CODE / CODICE	FRAME / STRUTTURA	ROPE / CORDA	Q.S / P.C	PRICE / €
HA639.AG	ancient grey / grigio antico	taupe / talpa	•	€ 1.243
HA639.BRO	bronze / bronzo	taupe / talpa		€ 1.243
HA639.BS	ivory white / bianco perla	taupe / talpa		€ 1.243
HA639.FA	grey mud / fango	taupe / talpa		€ 1.243

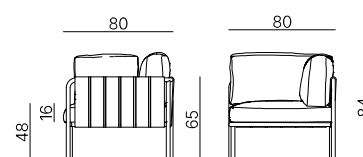



Cushion fabric set / Tessuti set cuscineria (1 seat cushion + 1 back cushion / 1 cuscino seduta + 1 cuscini schienale)

CODE / CODICE	BUSINESS	Q.S / P.C	PRICE	CODE / CODICE	SUNSET	Q.S / P.C	PRICE	CODE / CODICE	AVANT GARDE	Q.S / P.C	PRICE
KW600KIT.FOS	fossil	•	€ 260	KW600KIT.PERS	pergamino		€ 339	KW600KIT.CSS	cream star		€ 339
KW600KIT.ANS	anthracite		€ 260	KW600KIT.LIMS	limestone		€ 339				
KW600KIT.TPS	taupe		€ 260								
KW600KIT.GRS	grey		€ 260								

CUKW602 Corner cushion / Cuscino angolare (for / per HA639)

Removable Cushions / Cuscini sfoderabili
Washable / Lavabile
Waterproof gel-backing / Fodera impermeabile
Weight / Peso : 1,5 Kg

packaging / imballo  1  0,07  2 CM L 66 P 33 H 33

Cushion fabric set / Tessuti set cuscineria

CODE / CODICE	BUSINESS	Q.S / P.C	PRICE	CODE / CODICE	SUNSET	Q.S / P.C	PRICE	CODE / CODICE	AVANT GARDE	Q.S / P.C	PRICE
CUKW602.FOS	fossil	•	€ 194	CUKW602.PERS	pergamino		€ 213	CUKW602.CSS	cream star		€ 213
CUKW602.ANS	anthracite		€ 194	CUKW602.LIMS	limestone		€ 213				
CUKW602.TPS	taupe		€ 194								
CUKW602.GRS	grey		€ 194								

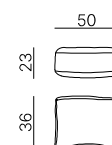



Hamptons

HA649 2 seater sofa / Divano 2 posti

TOTAL PRICE WITH BUSINESS CUSHIONS / PREZZO TOTALE CON CUSCINI BUSINESS	€ 2.815
TOTAL PRICE WITH SUNSET CUSHIONS / PREZZO TOTALE CON CUSCINI SUNSET	€ 3.121
TOTAL PRICE WITH AVANT-GARDE CUSHIONS / PREZZO TOTALE CON CUSCINI AVANT-GARDE	€ 3.121

Galvanized steel / Acciaio zincato
Elastic strap seat / Seduta in cinta elastica
Seat and back cushion included / Cuscino seduta e schienale inclusi
Removable Cushions / Cuscini sfoderabili

Washable / Lavabile
Waterproof gel-backing / Fodera impermeabile
Weight / Peso : 30 Kg

packaging / imballo  1  1  35 CM L 172 P 86 H 68

Frame / Struttura

CODE / CODICE	FRAME / STRUTTURA	ROPE / CORDA	Q.S / P.C	PRICE / €
HA649.AG	ancient grey / grigio antico	taupe / talpa	•	€ 2.126
HA649.BRO	bronze / bronzo	taupe / talpa		€ 2.126
HA649.BS	ivory white / bianco perla	taupe / talpa		€ 2.126
HA649.FA	grey mud / fango	taupe / talpa		€ 2.126

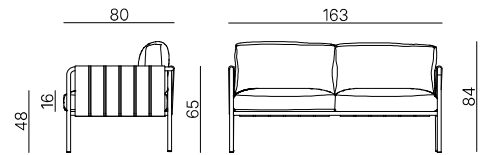

Cushion fabric set / Tessuti set cuscineria (2 seat cushion + 2 back cushion / 2 cuscini seduta + 2 cuscini schienale)

CODE / CODICE	BUSINESS	Q.S / P.C	PRICE	CODE / CODICE	SUNSET	Q.S / P.C	PRICE	CODE / CODICE	AVANT GARDE	Q.S / P.C	PRICE
KW640KIT.FOS	fossil	•	€ 689	KW640KIT.PERS	pergamino		€ 995	KW640KIT.CSS	cream star		€ 995
KW640KIT.ANS	anthracite		€ 689	KW640KIT.LIMS	limestone		€ 995				
KW640KIT.TPS	taupe		€ 689								
KW640KIT.GRS	grey		€ 689								

HA749 3 seater sofa / Divano 3 posti

TOTAL PRICE WITH BUSINESS CUSHIONS / PREZZO TOTALE CON CUSCINI BUSINESS € 3.365

TOTAL PRICE WITH SUNSET CUSHIONS / PREZZO TOTALE CON CUSCINI SUNSET € 3.824

TOTAL PRICE WITH AVANT-GARDE CUSHIONS / PREZZO TOTALE CON CUSCINI AVANT-GARDE € 3.824

Galvanized steel / Acciaio zincato



Elastic strap seat / Seduta in cinta elastica

Seat and back cushion included / Cuscino seduta e schienale inclusi

Removable Cushions / Cuscini sfoderabili

Washable / Lavabile

Waterproof gel-backing / Fodera impermeabile

Weight / Peso : 50 Kgpackaging / imballo  1  1,52  60 CM L 260 P 86 H 68**Frame / Struttura**

CODE / CODICE	FRAME / STRUTTURA	ROPE / CORDA	Q.S / P.C	PRICE / €
HA749.AG	ancient grey / grigio antico	taupe / talpa	•	€ 2.332
HA749.BRO	bronze / bronzo	taupe / talpa		€ 2.332
HA749.BS	ivory white / bianco perla	taupe / talpa		€ 2.332
HA749.FA	grey mud / fango	taupe / talpa		€ 2.332

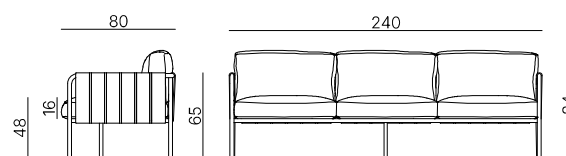
**Cushion fabric set / Tessuti set cuscineria (3 seat cushion + 3 back cushion / 3 cuscini seduta + 3 cuscini schienale)**

CODE / CODICE	BUSINESS	Q.S / P.C	PRICE	CODE / CODICE	SUNSET	Q.S / P.C	PRICE	CODE / CODICE	AVANT GARDE	Q.S / P.C	PRICE
KW740KIT.FOS	fossil	•	€ 1.033	KW740KIT.PERS	pergamino		€ 1.492	KW740KIT.CSS	cream star		€ 1.492
KW740KIT.ANS	anthracite		€ 1.033	KW740KIT.LIMS	limestone		€ 1.492				
KW740KIT.TPS	taupe		€ 1.033								
KW740KIT.GRS	grey		€ 1.033								

Hamptons

MI290 Pouf

TOTAL PRICE WITH BUSINESS CUSHIONS / PREZZO TOTALE CON CUSCINI BUSINESS € 625

TOTAL PRICE WITH SUNSET CUSHIONS / PREZZO TOTALE CON CUSCINI SUNSET € 688

TOTAL PRICE WITH AVANT-GARDE CUSHIONS / PREZZO TOTALE CON CUSCINI AVANT-GARDE € 688

Galvanized steel / Acciaio zincato

Elastic strap seat / Seduta in cinta elastica



Seat cushion included / Cuscino seduta incluso

Removable Cushions / Cuscini sfoderabili

Washable / Lavabile

Waterproof gel-backing / Fodera impermeabile

Weight / Peso : 10 Kg

packaging / imballo  1  0,25  12 CM L 84 P 84 H 34

Frame / Struttura

CODE / CODICE	FRAME / STRUTTURA	Q.S / P.C	PRICE / €
MI290.AG	ancient grey / grigio antico	•	€ 453
MI290.BRO	bronze / bronzo		€ 453
MI290.BS	ivory white / bianco perla		€ 453
MI290.FA	grey mud / fango		€ 453

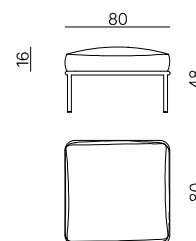



Cushion fabric set / Tessuti set cuscineria (1 seat cushion / 1 cuscino seduta)

CODE / CODICE	BUSINESS	Q.S / P.C	PRICE	CODE / CODICE	SUNSET	Q.S / P.C	PRICE	CODE / CODICE	AVANT GARDE	Q.S / P.C	PRICE
CUSKW600.FOS	fossil	•	€ 172	CUSKW600.PERS	pergamino		€ 235	CUSKW600.CSS	cream star		€ 235
CUSKW600.ANS	anthracite		€ 172	CUSKW600.LIMS	limestone		€ 235				
CUSKW600.TPS	taupe		€ 172								
CUSKW600.GRS	grey		€ 172								

MI200 Coffee table / Tavolo basso 80×80

Galvanized steel / Acciaio zincato

Stackable / Impilabile (4 pcs)

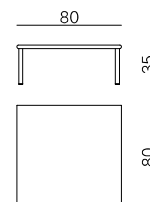

Weight / Peso : 7 Kgpackaging / imballo  1  0,25  12 CM L 84 P 84 H 36**Frame / Struttura**

CODE / CODICE	FRAME / STRUTTURA	Q.S / P.C	PRICE / €
MI200.AG	ancient grey / grigio antico	•	€ 229
MI200.BRO	bronze / bronzo		€ 229
MI200.BS	ivory white / bianco perla		€ 229
MI200.FA	grey mud / fango		€ 229

**DRESHA609 Backrest and Armrest Rope covering / Rivestimento in corda schienale e bracciolo**

Removable / Sfoderabile

Washable / Lavabile

Weight / Peso : 1,3 Kgpackaging / imballo  1  0,01  1,5 CM L 70 P 12 H 12**Frame / Struttura**

CODE / CODICE	ROPE / CORDA	Q.S / P.C	PRICE / €
DRESHA609	taupe / talpa		€ 348

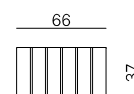

Hug

Designed by Studio Solido



frame / struttura

standard colours / colori standard



fabrics / tessuti

sunset



avant-garde

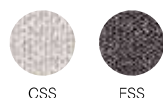

Pillow Pag. 174



More information on colors and fabrics from page 194 / Più informazioni su colori e tessuti da pagina 194

HG660 Lounge chair / Poltrona bassa

TOTAL PRICE WITH SUNSET CUSHIONS / PREZZO TOTALE CON CUSCINI SUNSET € 1.589

TOTAL PRICE WITH AVANT-GARDE CUSHIONS / PREZZO TOTALE CON CUSCINI AVANT-GARDE € 1.589

Galvanized steel / Acciaio zincato Washable / Lavabile
 Elastic strap seat / Seduta in cinta elastica Waterproof gel-backing / Fodera impermeabile
 Cushions included / Cuscini inclusi **Weight / Peso : 25 Kg**
 Removable Cushions / Cuscini sfoderabili

packaging / imballo  1  0,64  30 CM L 110 P 97 H 60

Frame / Struttura

CODE / CODICE	FRAME / STRUTTURA	Q.S / P.C	PRICE / €
HG660.AG	ancient grey / grigio antico		€ 739
HG660.BRO	bronze / bronzo		€ 739
HG660.BS	ivory white / bianco perla		€ 739

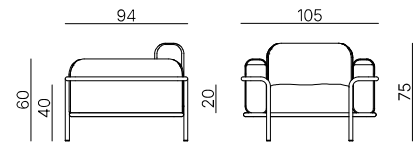

Cushion fabric set / Tessuti set cuscineria (1 seat cushion + 1 back cushion + 2 armrest cushion / 1 cuscino seduta + 1 cuscino schienale + 2 cuscini bracciolo)



CODE / CODICE	SUNSET	Q.S / P.C	PRICE	CODE / CODICE	AVANT GARDE	Q.S / P.C	PRICE
HG660KIT.PERS	pergamino		€ 850	HG660KIT.CSS	cream star		€ 850
HG660KIT.LIMS	limestone		€ 850	HG660KIT.FSS	mud grey star		€ 850

HG730 3 seater sofa / Divano 3 posti

TOTAL PRICE WITH SUNSET CUSHIONS / PREZZO TOTALE CON CUSCINI SUNSET € 3.110

TOTAL PRICE WITH AVANT-GARDE CUSHIONS / PREZZO TOTALE CON CUSCINI AVANT-GARDE € 3.110

Galvanized steel / Acciaio zincato Washable / Lavabile
 Elastic strap seat / Seduta in cinta elastica Waterproof gel-backing / Fodera impermeabile
 Cushions included / Cuscini inclusi **Weight / Peso : 45 Kg**
 Removable Cushions / Cuscini sfoderabili

packaging / imballo  1  1,40  60 CM L 240 P 97 H 60

Frame / Struttura

CODE / CODICE	FRAME / STRUTTURA	Q.S / P.C	PRICE / €
HG730.AG	ancient grey / grigio antico		€ 1.399
HG730.BRO	bronze / bronzo		€ 1.399
HG730.BS	ivory white / bianco perla		€ 1.399

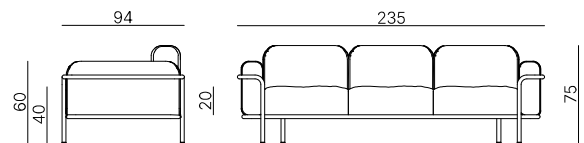

Cushion fabric set / Tessuti set cuscineria (3 seat cushions + 3 back cushions + 2 armrest cushion / 3 cuscini seduta + 3 cuscini schienale + 2 cuscini bracciolo)

CODE / CODICE	SUNSET	Q.S / P.C	PRICE	CODE / CODICE	AVANT GARDE	Q.S / P.C	PRICE
HG730KIT.PERS	pergamino		€ 1.711	HG730KIT.CSS	cream star		€ 1.711
HG730KIT.LIMS	limestone		€ 1.711	HG730KIT.FSS	mud grey star		€ 1.711

Key West

Designed by Vermobil Team



frame / struttura

standard colours / colori standard

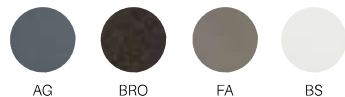

fabrics / tessuti

business



sunset



avant-garde





Pillow Pag. 174

More information on colors and fabrics from page 194 / Più informazioni su colori e tessuti da pagina 194

KW300 Armchair / Poltrona

Galvanized steel / Acciaio zincato
Weaved rope seat and backrest / Seduta e schienale incordati

Stackable / Impilabile (2 pcs)
Weight / Peso : 6,5 Kg

packaging / imballo  2  0,37  15 CM L 93 P 62 H 65

Frame / Struttura

CODE / CODICE	FRAME / STRUTTURA	ROPE / CORDA	Q.S / P.C	PRICE / €
KW300.AG/TP	ancient grey / grigio antico	taupe / talpa		€ 403
KW300.AG/NE	ancient grey / grigio antico	black / nero		€ 403
KW300.AG/FA	ancient grey / grigio antico	mud grey / fango	•	€ 403
KW300.BRO/TP	bronze / bronzo	taupe / talpa		€ 403
KW300.FA/FA	mud grey / fango	mud grey / fango		€ 403
KW300.BS/FA	ivory white / bianco perla	mud grey / fango		€ 403

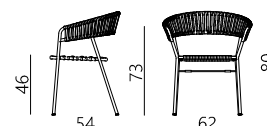

KW30X XL XL Armchair / Poltrona XL



TOTAL PRICE WITH BUSINESS CUSHIONS / PREZZO TOTALE CON CUSCINI BUSINESS € 602

TOTAL PRICE WITH SUNSET CUSHIONS / PREZZO TOTALE CON CUSCINI SUNSET € 634

TOTAL PRICE WITH AVANT-GARDE CUSHIONS / PREZZO TOTALE CON CUSCINI AVANT-GARDE € 634

Galvanized steel / Acciaio zincato
Seat cushion included / Cuscino seduta incluso
Backrest cushion not included / Cuscino schienale non incluso
Removable Cushion / Cuscino sfoderabile

Washable / Lavabile
Waterproof gel-backing / Fodera impermeabile
Weight / Peso : 7 Kg

packaging / imballo  1  0,39  10 CM L 87 P 69 H 65

Frame / Struttura

CODE / CODICE	FRAME / STRUTTURA	ROPE / CORDA	Q.S / P.C	PRICE / €
KW309XL.AG	ancient grey / grigio antico	taupe / talpa		€ 516
KW305XL.AG	ancient grey / grigio antico	black / nero		€ 516
KW304XL.AG	ancient grey / grigio antico	mud grey / fango		€ 516
KW309XL.BRO	bronze / bronzo	taupe / talpa		€ 516
KW304XL.FA	mud grey / fango	mud grey / fango		€ 516
KW304XL.BS	ivory white / bianco perla	mud grey / fango		€ 516

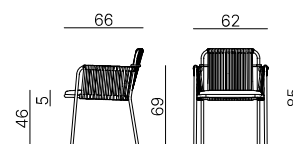

Cushion fabric set / Tessuti set cuscineria (1 seat cushion / 1 cuscino seduta)

CODE / CODICE	BUSINESS	Q.S / P.C	PRICE	CODE / CODICE	SUNSET	Q.S / P.C	PRICE	CODE / CODICE	AVANT GARDE	Q.S / P.C	PRICE
CUSKW300XL.FOS	fossil		€ 86	CUSKW300XL.PERS	pergamino		€ 118	CUSKW300XL.CSS	cream star		€ 118
CUSKW300XL.ANS	anthracite		€ 86	CUSKW300XL.LIMS	limestone		€ 118				
CUSKW300XL.TPS	taupe		€ 86								
CUSKW300XL.GRS	grey		€ 86								

Key West

CUBKW300XL Backrest cushion / Cuscino schienale (for / per KW30X XL)

Removable Cushion / Cuscino sfoderabile
Washable / Lavabile

Waterproof gel-backing / Fodera impermeabile
Weight / Peso : 0,4 Kg

packaging / imballo  1  0,01  1 CM L 52 P 41 H 6

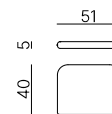

Cushion fabric set / Tessuti set cuscineria

CODE / CODICE	BUSINESS	Q.S / P.C	PRICE	CODE / CODICE	SUNSET	Q.S / P.C	PRICE	CODE / CODICE	AVANT GARDE	Q.S / P.C	PRICE
CUBKW300XL.FOS	fossil		€ 111	CUBKW300XL.PERS	pergamino		€ 122	CUBKW300XL.CSS	cream star		€ 122
CUBKW300XL.ANS	anthracite		€ 111	CUBKW300XL.LIMS	limestone		€ 122				
CUBKW300XL.TPS	taupe		€ 111								
CUBKW300XL.GRS	grey		€ 111								

KW66X Lounge chair / Poltrona bassa

TOTAL PRICE WITH BUSINESS CUSHIONS / PREZZO TOTALE CON CUSCINI BUSINESS € 1.448

TOTAL PRICE WITH SUNSET CUSHIONS / PREZZO TOTALE CON CUSCINI SUNSET € 1.527

TOTAL PRICE WITH AVANT-GARDE CUSHIONS / PREZZO TOTALE CON CUSCINI AVANT-GARDE € 1.527

Galvanized steel / Acciaio zincato

Elastic strap seat / Seduta in cinta elastica



Seat and back cushion included / Cuscino seduta e schienale inclusi

Removable Cushions / Cuscini sfoderabili

Washable / Lavabile

Waterproof gel-backing / Fodera impermeabile

Weight / Peso : 28,5 Kg

packaging / imballo  1  0,5  32,5 CM L 86 P 86 H 68

Frame / Struttura

CODE / CODICE	FRAME / STRUTTURA	ROPE / CORDA	Q.S / P.C	PRICE / €
KW669.AG	ancient grey / grigio antico	taupe / talpa		€ 1.188
KW665.AG	ancient grey / grigio antico	black / nero		€ 1.188
KW664.AG	ancient grey / grigio antico	mud grey / fango	•	€ 1.188
KW669.BRO	bronze / bronzo	taupe / talpa		€ 1.188
KW664.FA	mud grey / fango	mud grey / fango		€ 1.188
KW664.BS	ivory white / bianco perla	mud grey / fango		€ 1.188

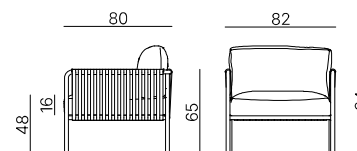

Cushion fabric set / Tessuti set cuscineria (1 seat cushion + 1 back cushion / 1 cuscino seduta + 1 cuscini schienale)

CODE / CODICE	BUSINESS	Q.S / P.C	PRICE	CODE / CODICE	SUNSET	Q.S / P.C	PRICE	CODE / CODICE	AVANT GARDE	Q.S / P.C	PRICE
KW600KIT.FOS	fossil	•	€ 260	KW600KIT.PERS	pergamino		€ 339	KW600KIT.CSS	cream star		€ 339
KW600KIT.ANS	anthracite		€ 260	KW600KIT.LIMS	limestone		€ 339				
KW600KIT.TPS	taupe		€ 260								
KW600KIT.GRS	grey		€ 260								

KW60X Single seat module / Modulo singolo

TOTAL PRICE WITH BUSINESS CUSHIONS / PREZZO TOTALE CON CUSCINI BUSINESS	€ 997
TOTAL PRICE WITH SUNSET CUSHIONS / PREZZO TOTALE CON CUSCINI SUNSET	€ 1.076
TOTAL PRICE WITH AVANT-GARDE CUSHIONS / PREZZO TOTALE CON CUSCINI AVANT-GARDE	€ 1.076

Galvanized steel / Acciaio zincato



Elastic strap seat / Seduta in cinta elastica

Seat and back cushion included / Cuscino seduta e schienale inclusi

Removable Cushions / Cuscini sfoderabili

Washable / Lavabile

Waterproof gel-backing / Fodera impermeabile

Weight / Peso : 18 Kgpackaging / imballo  1  0,5  21 CM L 86 P 86 H 68**Frame / Struttura**

CODE / CODICE	FRAME / STRUTTURA	ROPE / CORDA	Q.S / P.C	PRICE / €
KW609.AG	ancient grey / grigio antico	taupe / talpa		€ 737
KW605.AG	ancient grey / grigio antico	black / nero		€ 737
KW604.AG	ancient grey / grigio antico	mud grey / fango	•	€ 737
KW609.BRO	bronze / bronzo	taupe / talpa		€ 737
KW604.FA	mud grey / fango	mud grey / fango		€ 737
KW604.BS	ivory white / bianco perla	mud grey / fango		€ 737

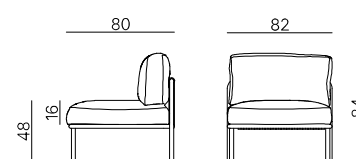
**Cushion fabric set / Tessuti set cuscineria (1 seat cushion + 1 back cushion / 1 cuscino seduta + 1 cuscini schienale)**

CODE / CODICE	BUSINESS	Q.S / P.C	PRICE	CODE / CODICE	SUNSET	Q.S / P.C	PRICE	CODE / CODICE	AVANT GARDE	Q.S / P.C	PRICE
KW600KIT.FOS	fossil	•	€ 260	KW600KIT.PERS	pergamino		€ 339	KW600KIT.CSS	cream star		€ 339
KW600KIT.ANS	anthracite		€ 260	KW600KIT.LIMS	limestone		€ 339				
KW600KIT.TPS	taupe		€ 260								
KW600KIT.GRS	grey		€ 260								



Kew West

KW63X Corner module / Modulo angolo

TOTAL PRICE WITH BUSINESS CUSHIONS / PREZZO TOTALE CON CUSCINI BUSINESS	€ 1.280
TOTAL PRICE WITH SUNSET CUSHIONS / PREZZO TOTALE CON CUSCINI SUNSET	€ 1.359
TOTAL PRICE WITH AVANT-GARDE CUSHIONS / PREZZO TOTALE CON CUSCINI AVANT-GARDE	€ 1.359

Galvanized steel / Acciaio zincato
Elastic strap seat / Seduta in cinta elastica
Seat and back cushion included / Cuscino seduta e schienale inclusi
Corner cushion not included / Cuscino angolare non incluso

Removable Cushions / Cuscini sfoderabili
Washable / Lavabile
Waterproof gel-backing / Fodera impermeabile
Weight / Peso : 20 Kg

packaging / imballo  1  0,5  23 CM L 86 P 86 H 68

Frame / Struttura

CODE / CODICE	FRAME / STRUTTURA	ROPE / CORDA	Q.S / P.C	PRICE / €
KW639.AG	ancient grey / grigio antico	taupe / talpa		€ 1.020
KW635.AG	ancient grey / grigio antico	black / nero		€ 1.020
KW634.AG	ancient grey / grigio antico	mud grey / fango	•	€ 1.020
KW639.BRO	bronze / bronzo	taupe / talpa		€ 1.020
KW634.FA	mud grey / fango	mud grey / fango		€ 1.020
KW634.BS	ivory white / bianco perla	mud grey / fango		€ 1.020

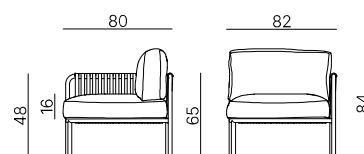



Cushion fabric set / Tessuti set cuscineria (1 seat cushion + 1 back cushion / 1 cuscino seduta + 1 cuscini schienale)

CODE / CODICE	BUSINESS	Q.S / P.C	PRICE	CODE / CODICE	SUNSET	Q.S / P.C	PRICE	CODE / CODICE	AVANT GARDE	Q.S / P.C	PRICE
KW600KIT.FOS	fossil	•	€ 260	KW600KIT.PERS	pergamino		€ 339	KW600KIT.CSS	cream star		€ 339
KW600KIT.ANS	anthracite		€ 260	KW600KIT.LIMS	limestone		€ 339				
KW600KIT.TPS	taupe		€ 260								
KW600KIT.GRS	grey		€ 260								

CUKW602 Corner cushion / Cuscino angolare (for / per KW63X)

Removable Cushion / Cuscino sfoderabile
Washable / Lavabile

Waterproof gel-backing / Fodera impermeabile
Weight / Peso : 1,5 Kg

packaging / imballo  1  0,07  2,2 CM L 66 P 33 H 33

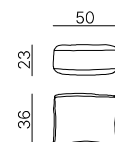

Cushion fabric set / Tessuti set cuscineria

CODE / CODICE	BUSINESS	Q.S / P.C	PRICE	CODE / CODICE	SUNSET	Q.S / P.C	PRICE	CODE / CODICE	AVANT GARDE	Q.S / P.C	PRICE
CUKW602.FOS	fossil		€ 194	CUKW602.PERS	pergamino		€ 213	CUKW602.CSS	cream star		€ 213
CUKW602.ANS	anthracite		€ 194	CUKW602.LIMS	limestone		€ 213				
CUKW602.TPS	taupe		€ 194								
CUKW602.GRS	grey		€ 194								

KW64X 2 seater sofa / Divano 2 posti

TOTAL PRICE WITH BUSINESS CUSHIONS / PREZZO TOTALE CON CUSCINI BUSINESS	€ 1.976
TOTAL PRICE WITH SUNSET CUSHIONS / PREZZO TOTALE CON CUSCINI SUNSET	€ 2.282
TOTAL PRICE WITH AVANT-GARDE CUSHIONS / PREZZO TOTALE CON CUSCINI AVANT-GARDE	€ 2.226

Galvanized steel / Acciaio zincato



Elastic strap seat / Seduta in cinta elastica

Seat and back cushion included / Cuscino seduta e schienale inclusi

Removable Cushions / Cuscini sfoderabili

Washable / Lavabile

Waterproof gel-backing / Fodera impermeabile

Weight / Peso : 40 Kgpackaging / imballo  1  0.98  50 CM L 167 P 86 H 68**Frame / Struttura**

CODE / CODICE	FRAME / STRUTTURA	ROPE / CORDA	Q.S / P.C	PRICE / €
KW649.AG	ancient grey / grigio antico	taupe / talpa		€ 1.287
KW645.AG	ancient grey / grigio antico	black / nero		€ 1.287
KW644.AG	ancient grey / grigio antico	mud grey / fango	•	€ 1.287
KW649.BRO	bronze / bronzo	taupe / talpa		€ 1.287
KW644.FA	mud grey / fango	mud grey / fango		€ 1.287
KW644.BS	ivory white / bianco perla	mud grey / fango		€ 1.287

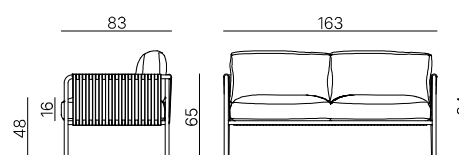
**Cushion fabric set / Tessuti set cuscineria (2 seat cushions + 2 back cushions / 2 cuscini seduta + 2 cuscini schienale)**

CODE / CODICE	BUSINESS	Q.S / P.C	PRICE	CODE / CODICE	SUNSET	Q.S / P.C	PRICE	CODE / CODICE	AVANT GARDE	Q.S / P.C	PRICE
KW640KIT.FOS	fossil	•	€ 689	KW640KIT.PERS	pergamino		€ 995	KW640KIT.CSS	cream star		€ 995
KW640KIT.ANS	anthracite		€ 689	KW640KIT.LIMS	limestone		€ 995				
KW640KIT.TPS	taupe		€ 689								
KW640KIT.GRS	grey		€ 689								

Kew West

KW74X 3 seater sofa / Divano 3 posti

TOTAL PRICE WITH BUSINESS CUSHIONS / PREZZO TOTALE CON CUSCINI BUSINESS	€ 3.094
TOTAL PRICE WITH SUNSET CUSHIONS / PREZZO TOTALE CON CUSCINI SUNSET	€ 3.553
TOTAL PRICE WITH AVANT-GARDE CUSHIONS / PREZZO TOTALE CON CUSCINI AVANT-GARDE	€ 3.553

Galvanized steel / Acciaio zincato

Elastic strap seat / Seduta in cinta elastica



Seat and back cushion included / Cuscino seduta e schienale inclusi

Removable Cushions / Cuscini sfoderabili

Washable / Lavabile

Waterproof gel-backing / Fodera impermeabile

Weight / Peso : 65 Kg

packaging / imballo  1  1,52  75 CM L 260 P 86 H 68

Frame / Struttura

CODE / CODICE	FRAME / STRUTTURA	ROPE / CORDA	Q.S / P.C	PRICE / €
KW749.AG	ancient grey / grigio antico	taupe / talpa		€ 2.061
KW745.AG	ancient grey / grigio antico	black / nero		€ 2.061
KW744.AG	ancient grey / grigio antico	mud grey / fango		€ 2.061
KW749.BRO	bronze / bronzo	taupe / talpa		€ 2.061
KW744.FA	mud grey / fango	mud grey / fango		€ 2.061
KW744.BS	ivory white / bianco perla	mud grey / fango		€ 2.061

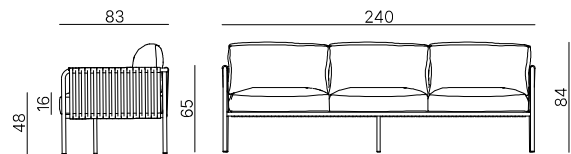

Cushion fabric set / Tessuti set cuscineria (3 seat cushion + 3 back cushion / 3 cuscini seduta + 3 cuscini schienale)

CODE / CODICE	BUSINESS	Q.S / P.C	PRICE	CODE / CODICE	SUNSET	Q.S / P.C	PRICE	CODE / CODICE	AVANT GARDE	Q.S / P.C	PRICE
KW740KIT.FOS	fossil		€ 1.033	KW740KIT.PERS	pergamino		€ 1.492	KW740KIT.CSS	cream star		€ 1.492
KW740KIT.ANS	anthracite		€ 1.033	KW740KIT.LIMS	limestone		€ 1.492				
KW740KIT.TPS	taupe		€ 1.033								
KW740KIT.GRS	grey		€ 1.033								



MI290 Pouf

TOTAL PRICE WITH BUSINESS CUSHIONS / PREZZO TOTALE CON CUSCINI BUSINESS € 625

TOTAL PRICE WITH SUNSET CUSHIONS / PREZZO TOTALE CON CUSCINI SUNSET € 688

TOTAL PRICE WITH AVANT-GARDE CUSHIONS / PREZZO TOTALE CON CUSCINI AVANT-GARDE € 688

Galvanized steel / Acciaio zincato Washable / Lavabile
 Elastic strap seat / Seduta in cinta elastica Waterproof gel-backing / Fodera impermeabile
 Seat cushion included / Cuscino seduta incluso **Weight / Peso : 10 Kg**
 Removable Cushions / Cuscini sfoderabili

packaging / imballo  1  0,25  12 CM L 84 P 84 H 34

Frame / Struttura

CODE / CODICE	FRAME / STRUTTURA	Q.S / P.C	PRICE / €
MI290.AG	ancient grey / grigio antico	•	€ 453
MI290.BRO	bronze / bronzo		€ 453
MI290.BS	ivory white / bianco perla		€ 453
MI290.FA	grey mud / fango		€ 453

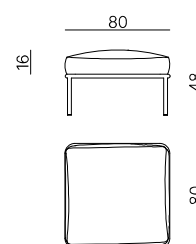

Cushion fabric set / Tessuti set cuscineria (1 seat cushion / 1 cuscino seduta)



CODE / CODICE	BUSINESS	Q.S / P.C	PRICE	CODE / CODICE	SUNSET	Q.S / P.C	PRICE	CODE / CODICE	AVANT GARDE	Q.S / P.C	PRICE
CUSKW600.FOS	fossil	•	€ 172	CUSKW600.PERS	pergamino		€ 235	CUSKW600.CSS	cream star		€ 235
CUSKW600.ANS	anthracite		€ 172	CUSKW600.LIMS	limestone		€ 235				
CUSKW600.TPS	taupe		€ 172								
CUSKW600.GRS	grey		€ 172								

MI200 Coffee table / Tavolo basso 80×80

Galvanized steel / Acciaio zincato

Stackable / impilabile (4 pcs)

Weight / Peso : 7 Kg

packaging / imballo  1  0,25  12 CM L 84 P 84 H 36

Frame / Struttura

CODE / CODICE	FRAME / STRUTTURA	Q.S / P.C	PRICE / €
MI200.AG	ancient grey / grigio antico	•	€ 229
MI200.BRO	bronze / bronzo		€ 229
MI200.BS	ivory white / bianco perla		€ 229
MI200.FA	grey mud / fango		€ 229

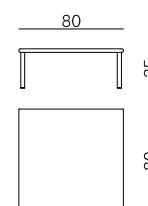

Miami

Designed by Roberto Capati



frame / struttura

standard colours / colori standard



fabrics / tessuti

business



sunset



avant-garde



Pillow Pag. 174

More information on colors and fabrics from page 194 / Più informazioni su colori e tessuti da pagina 194

MI660 Lounge chair / Poltrona bassa

TOTAL PRICE WITH BUSINESS CUSHIONS / PREZZO TOTALE CON CUSCINI BUSINESS € 845

TOTAL PRICE WITH SUNSET CUSHIONS / PREZZO TOTALE CON CUSCINI SUNSET € 924

TOTAL PRICE WITH AVANT-GARDE CUSHIONS / PREZZO TOTALE CON CUSCINI AVANT-GARDE € 924

Galvanized steel / Acciaio zincato



Elastic strap seat / Seduta in cinta elastica

Seat and back cushion included / Cuscino seduta e schienale inclusi

Removable Cushions / Cuscini sfoderabili

Washable / Lavabile

Waterproof gel-backing / Fodera impermeabile

Weight / Peso : 20 Kgpackaging / imballo  1  0,5  23 CM L 86 P 86 H 68**Frame / Struttura**

CODE / CODICE	FRAME / STRUTTURA	Q.S / P.C	PRICE / €
MI660.AG	ancient grey / grigio antico	•	€ 585
MI660.BRO	bronze / bronzo		€ 585
MI660.BS	ivory white / bianco perla		€ 585
MI660.FA	mud grey / fango		€ 585

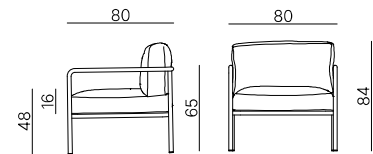
**Cushion fabric set / Tessuti set cuscineria (1 seat cushion + 1 back cushion / 1 cuscino seduta + 1 cuscino schienale)**

CODE / CODICE	BUSINESS	Q.S / P.C	PRICE	CODE / CODICE	SUNSET	Q.S / P.C	PRICE	CODE / CODICE	AVANT GARDE	Q.S / P.C	PRICE
KW600KIT.FOS	fossil	•	€ 260	KW600KIT.PERS	pergamino	•	€ 339	KW600KIT.CSS	cream star		€ 339
KW600KIT.ANS	anthracite		€ 260	KW600KIT.LIMS	limestone		€ 339				
KW600KIT.TPS	taupe		€ 260								
KW600KIT.GRS	grey		€ 260								

Miami

MI600 Single seat module / Modulo singolo

TOTAL PRICE WITH BUSINESS CUSHIONS / PREZZO TOTALE CON CUSCINI BUSINESS € 785

TOTAL PRICE WITH SUNSET CUSHIONS / PREZZO TOTALE CON CUSCINI SUNSET € 864

TOTAL PRICE WITH AVANT-GARDE CUSHIONS / PREZZO TOTALE CON CUSCINI AVANT-GARDE € 864

Galvanized steel / Acciaio zincato

Elastic strap seat / Seduta in cinta elastica



Seat and back cushion included / Cuscino seduta e schienale inclusi

Removable Cushions / Cuscini sfoderabili

Washable / Lavabile

Waterproof gel-backing / Fodera impermeabile

Weight / Peso : 16 Kg

packaging / imballo  1  0,5  19 CM L 86 P 86 H 68

Frame / Struttura

CODE / CODICE	FRAME / STRUTTURA	Q.S / P.C	PRICE / €
MI600.AG	ancient grey / grigio antico	•	€ 525
MI600.BRO	bronze / bronzo		€ 525
MI600.BS	ivory white / bianco perla		€ 525
MI600.FA	mud grey / fango		€ 525

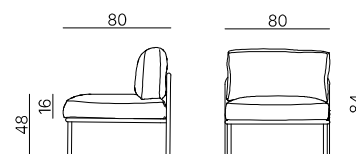

Cushion fabric set / Tessuti set cuscineria (1 seat cushion + 1 back cushion / 1 cuscino seduta + 1 cuscino schienale)

CODE / CODICE	BUSINESS	Q.S / P.C	PRICE	CODE / CODICE	SUNSET	Q.S / P.C	PRICE	CODE / CODICE	AVANT GARDE	Q.S / P.C	PRICE
KW600KIT.FOS	fossil	•	€ 260	KW600KIT.PERS	pergamino	•	€ 339	KW600KIT.CSS	cream star		€ 339
KW600KIT.ANS	anthracite		€ 260	KW600KIT.LIMS	limestone		€ 339				
KW600KIT.TPS	taupe		€ 260								
KW600KIT.GRS	grey		€ 260								

MI630 Corner module / Modulo angolo

TOTAL PRICE WITH BUSINESS CUSHIONS / PREZZO TOTALE CON CUSCINI BUSINESS € 809

TOTAL PRICE WITH SUNSET CUSHIONS / PREZZO TOTALE CON CUSCINI SUNSET € 888

TOTAL PRICE WITH AVANT-GARDE CUSHIONS / PREZZO TOTALE CON CUSCINI AVANT-GARDE € 888

Galvanized steel / Acciaio zincato

Elastic strap seat / Seduta in cinta elastica

Seat and back cushion included / Cuscino seduta e schienale inclusi



Corner cushion not included / Cuscino angolare non incluso

Removable Cushions / Cuscini sfoderabili

Washable / Lavabile

Waterproof gel-backing / Fodera impermeabile

Weight / Peso : 18 Kg

packaging / imballo  1  0,5  21 CM L 86 P 86 H 68

Frame / Struttura

CODE / CODICE	FRAME / STRUTTURA	Q.S / P.C	PRICE / €
MI630.AG	ancient grey / grigio antico	•	€ 549
MI630.BRO	bronze / bronzo		€ 549
MI630.BS	ivory white / bianco perla		€ 549
MI630.FA	mud grey / fango		€ 549

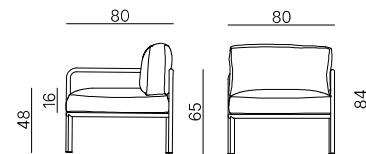

Cushion fabric set / Tessuti set cuscineria (1 seat cushion + 1 back cushion / 1 cuscino seduta + 1 cuscino schienale)

CODE / CODICE	BUSINESS	Q.S / P.C	PRICE	CODE / CODICE	SUNSET	Q.S / P.C	PRICE	CODE / CODICE	AVANT GARDE	Q.S / P.C	PRICE
KW600KIT.FOS	fossil	•	€ 260	KW600KIT.PERS	pergamino	•	€ 339	KW600KIT.CSS	cream star		€ 339
KW600KIT.ANS	anthracite		€ 260	KW600KIT.LIMS	limestone		€ 339				
KW600KIT.TPS	taupe		€ 260								
KW600KIT.GRS	grey		€ 260								

CUKW602 Corner cushion / Cuscino angolare (for / per MI630)

Removable Cushion / Cuscino sfoderabile

Washable / Lavabile

Waterproof gel-backing / Fodera impermeabile

Weight / Peso : 1,5 Kg

packaging / imballo  1  0,07  2,2 CM L 66 P 33 H 33

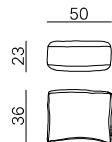

Cushion fabric set / Tessuti set cuscineria

CODE / CODICE	BUSINESS	Q.S / P.C	PRICE	CODE / CODICE	SUNSET	Q.S / P.C	PRICE	CODE / CODICE	AVANT GARDE	Q.S / P.C	PRICE
CUKW602.FOS	fossil		€ 194	CUKW602.PERS	pergamino		€ 213	CUKW602.CSS	cream star		€ 213
CUKW602.ANS	anthracite		€ 194	CUKW602.LIMS	limestone		€ 213				
CUKW602.TPS	taupe		€ 194								
CUKW602.GRS	grey		€ 194								



Miami

MI640 2 seater sofa / Divano 2 posti

TOTAL PRICE WITH BUSINESS CUSHIONS / PREZZO TOTALE CON CUSCINI BUSINESS	€ 1.424
TOTAL PRICE WITH SUNSET CUSHIONS / PREZZO TOTALE CON CUSCINI SUNSET	€ 1.730
TOTAL PRICE WITH AVANT-GARDE CUSHIONS / PREZZO TOTALE CON CUSCINI AVANT-GARDE	€ 1.730

Galvanized steel / Acciaio zincato
Elastic strap seat / Seduta in cinta elastica
Seat and back cushion included / Cuscino seduta e schienale inclusi
Removable Cushions / Cuscini sfoderabili

Washable / Lavabile
Waterproof gel-backing / Fodera impermeabile
Weight / Peso : 30 Kg

packaging / imballo  1  1  35 CM L 172 P 86 H 68

Frame / Struttura

CODE / CODICE	FRAME / STRUTTURA	Q.S / P.C	PRICE / €
MI640.AG	ancient grey / grigio antico	•	€ 735
MI640.BRO	bronze / bronzo		€ 735
MI640.BS	ivory white / bianco perla		€ 735
MI640.FA	mud grey / fango		€ 735

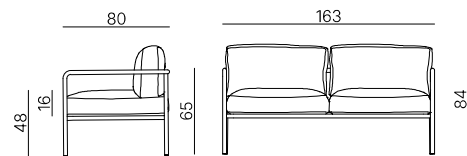

Cushion fabric set / Tessuti set cuscineria (2 seat cushion + 2 back cushion / 2 cuscini seduta + 2 cuscini schienale)

CODE / CODICE	BUSINESS	Q.S / P.C	PRICE	CODE / CODICE	SUNSET	Q.S / P.C	PRICE	CODE / CODICE	AVANT GARDE	Q.S / P.C	PRICE
KW640KIT.FOS	fossil	•	€ 689	KW640KIT.PERS	pergamino		€ 995	KW640KIT.CSS	cream star		€ 995
KW640KIT.ANS	anthracite		€ 689	KW640KIT.LIMS	limestone		€ 995				
KW640KIT.TPS	taupe		€ 689								
KW640KIT.GRS	grey		€ 689								

MI740 3 seater sofa / Divano 3 posti

TOTAL PRICE WITH BUSINESS CUSHIONS / PREZZO TOTALE CON CUSCINI BUSINESS	€ 2.300
TOTAL PRICE WITH SUNSET CUSHIONS / PREZZO TOTALE CON CUSCINI SUNSET	€ 2.759
TOTAL PRICE WITH AVANT-GARDE CUSHIONS / PREZZO TOTALE CON CUSCINI AVANT-GARDE	€ 2.759

Galvanized steel / Acciaio zincato
 Elastic strap seat / Seduta in cinta elastica
 Seat and back cushion included / Cuscino seduta e schienale inclusi
 Corner cushion not included / Cuscino angolare non incluso

Removable Cushions / Cuscini sfoderabili
 Washable / Lavabile
 Waterproof gel-backing / Fodera impermeabile
Weight / Peso : 50 Kg

packaging / imballo  1  1,52  60 CM L 260 P 86 H 68

Frame / Struttura

CODE / CODICE	FRAME / STRUTTURA	Q.S / P.C	PRICE / €
MI740.AG	ancient grey / grigio antico	•	€ 1.267
MI740.BRO	bronze / bronzo		€ 1.267
MI740.BS	ivory white / bianco perla		€ 1.267
MI740.FA	mud grey / fango		€ 1.267

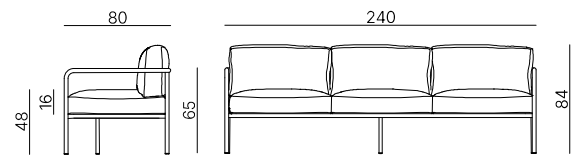
**Cushion fabric set / Tessuti set cuscineria (3 seat cushion + 3 back cushion / 3 cuscini seduta + 3 cuscini schienale)**

CODE / CODICE	BUSINESS	Q.S / P.C	PRICE	CODE / CODICE	SUNSET	Q.S / P.C	PRICE	CODE / CODICE	AVANT GARDE	Q.S / P.C	PRICE
KW740KIT.FOS	fossil	•	€ 1.033	KW740KIT.PERS	pergamino		€ 1.492	KW740KIT.CSS	cream star		€ 1.492
KW740KIT.ANS	anthracite		€ 1.033	KW740KIT.LIMS	limestone		€ 1.492				
KW740KIT.TPS	taupe		€ 1.033								
KW740KIT.GRS	grey		€ 1.033								

Miami

MI290 Pouf

TOTAL PRICE WITH BUSINESS CUSHIONS / PREZZO TOTALE CON CUSCINI BUSINESS € 625

TOTAL PRICE WITH SUNSET CUSHIONS / PREZZO TOTALE CON CUSCINI SUNSET € 688

TOTAL PRICE WITH AVANT-GARDE CUSHIONS / PREZZO TOTALE CON CUSCINI AVANT-GARDE € 688

Galvanized steel / Acciaio zincato

Elastic strap seat / Seduta in cinta elastica



Seat cushion included / Cuscino seduta incluso

Removable Cushions / Cuscini sfoderabili

Washable / Lavabile

Waterproof gel-backing / Fodera impermeabile

Weight / Peso : 10 Kg

packaging / imballo  1  0,25  12 CM L 84 P 84 H 34

Frame / Struttura

CODE / CODICE	FRAME / STRUTTURA	Q.S / P.C	PRICE / €
MI290.AG	ancient grey / grigio antico	•	€ 453
MI290.BRO	bronze / bronzo		€ 453
MI290.BS	ivory white / bianco perla		€ 453
MI290.FA	grey mud / fango		€ 453

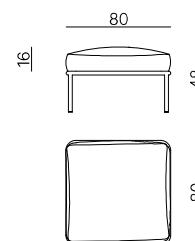

Cushion fabric set / Tessuti set cuscineria (1 seat cushion / 1 cuscino seduta)



CODE / CODICE	BUSINESS	Q.S / P.C	PRICE	CODE / CODICE	SUNSET	Q.S / P.C	PRICE	CODE / CODICE	AVANT GARDE	Q.S / P.C	PRICE
CUSKW600.FOS	fossil	•	€ 172	CUSKW600.PERS	pergamino		€ 235	CUSKW600.CSS	cream star		€ 235
CUSKW600.ANS	anthracite		€ 172	CUSKW600.LIMS	limestone		€ 235				
CUSKW600.TPS	taupe		€ 172								
CUSKW600.GRS	grey		€ 172								

MI200 Coffee table / Tavolo basso 80×80

Galvanized steel / Acciaio zincato

Stackable / impilabile (4 pcs)

Weight / Peso : 7 Kg

packaging / imballo  1  0,25  12 CM L 84 P 84 H 36

Frame / Struttura

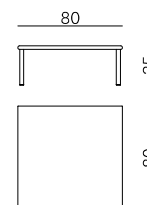

CODE / CODICE	FRAME / STRUTTURA	Q.S / P.C	PRICE / €
MI200.AG	ancient grey / grigio antico	•	€ 229
MI200.BRO	bronze / bronzo		€ 229
MI200.BS	ivory white / bianco perla		€ 229
MI200.FA	grey mud / fango		€ 229



MI413 Sunbed / Lettino

Galvanized steel and Aluminium / Acciaio zincato e alluminio
Batyline fabric / Tessuto Batyline

Stackable / Impilabile (10 pcs)
Weight / Peso : 15 Kg

packaging / imballo  2  1,04  39 CM L 195 P 90 H 59

Frame / Struttura

CODE / CODICE	FRAME / STRUTTURA	BATYLINE	Q.S / P.C	PRICE / €
MI413.AG/NE	ancient grey / grigio antico	black / nero	•	€ 671
MI413.FA/TO	mud grey / fango	taupe / tortora	•	€ 671
MI413.BS/BCO	ivory white / bianco perla	white / bianco	•	€ 671

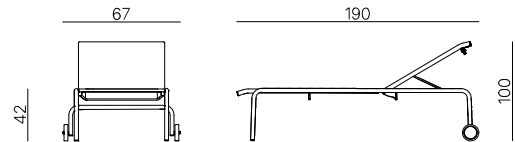

PS413 Sunshade / Tettino parasole

Galvanized steel and Aluminium / Acciaio zincato e alluminio
Batyline fabric / Tessuto Batyline

Stackable / Impilabile (10 pcs)
Weight / Peso : 2 Kg

packaging / imballo  1  0,03  3 CM L 70 P 67 H 7

CODE / CODICE	FRAME / STRUTTURA	BATYLINE	Q.S / P.C	PRICE / €
PS413.AG/NE	ancient grey / grigio antico	black / nero		€ 203
PS413.FA/TO	mud grey / fango	taupe / tortora		€ 203
PS413.BS/BCO	ivory white / bianco perla	white / bianco		€ 203

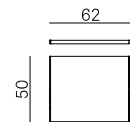

Mimmo Rondò

Designed by Vermobil Team



frame / struttura

standard colours / colori standard

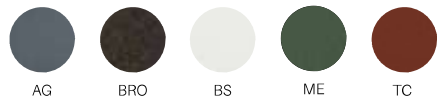

fabrics / tessuti

business

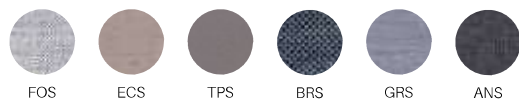



More information on colors and fabrics from page 194 / Più informazioni su colori e tessuti da pagina 194

SP102 Chair / Sedia

Galvanized steel / Acciaio zincato

Stackable / Impilabile (4 pcs)

Weight / Peso : 5 Kg

packaging / imballo  2  0,27  13 CM L 97 P 60 H 47

Frame / Struttura

CODE / CODICE	FRAME / STRUTTURA	Q.S / P.C	PRICE / €
SP102.AG	ancient grey / grigio antico	•	€ 129
SP102.BRO	bronze / bronzo		€ 129
SP102.BS	ivory white / bianco perla	•	€ 129
SP102.ME	mint green / menta		€ 129
SP102.TC	terracotta / terracotta		€ 129

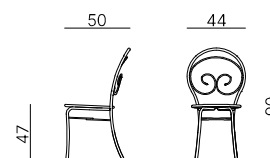



SP111 Armchair / Poltrona

Galvanized steel / Acciaio zincato

Stackable / Impilabile (4 pcs)

Weight / Peso : 6 Kg

packaging / imballo  2  0,31  14 CM L 104 P 55 H 55

Frame / Struttura

CODE / CODICE	FRAME / STRUTTURA	Q.S / P.C	PRICE / €
SP111.AG	ancient grey / grigio antico	•	€ 143
SP111.BRO	bronze / bronzo		€ 143
SP111.BS	ivory white / bianco perla	•	€ 143
SP111.ME	mint green / menta		€ 143
SP111.TC	terracotta / terracotta		€ 143

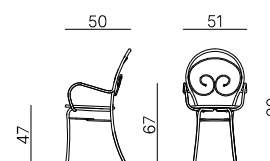

CU102 Seat cushion / Cuscino seduta (for / per SP102, SP111)

Removable Cushion / Cuscino sfoderabile

Washable / Lavabile

Waterproof gel-backing / Fodera impermeabile

Weight / Peso : 0,3 Kg

packaging / imballo  1  0,01  0,5 cm L 44 P 43 H 6

Cushion fabric set / Tessuti set cuscineria

CODE / CODICE	BUSINESS	Q.S / P.C	PRICE
CU102.FOS	fossil	•	€ 56



Mimmo Rondò

CUSRM37 Seat cushion / Cuscino seduta (for / per SP102, SP111)

Non-removable / Non sfoderabile



Anti-slip / Antiscivolo

With magnet / Con calamita

Washable / Lavabile

Waterproof gel-backing / Fodera impermeabile

Weight / Peso : 0,2 Kg

packaging / imballo  1  0,01  0,4 CM L 39 P 39 H 3

Cushion fabric set / Tessuti set cuscineria

CODE / CODICE	BUSINESS	Q.S / P.C	PRICE
CUSRM37.FOS	fossil	•	€ 45
CUSRM37.ECS	ecru		€ 45
CUSRM37.TPS	taupe		€ 45
CUSRM37.BRS	brisa		€ 45
CUSRM37.GRS	grey		€ 45
CUSRM37.ANS	anthracite		€ 45





SP119 Table / Tavolo Ø60

Galvanized steel / Acciaio zincato

Knockdown / Smontabile

Weight / Peso : 8 Kg

packaging / imballo  1  0,06  10 CM L 65 P 61 H 14

Frame / Struttura

CODE / CODICE	FRAME / STRUTTURA	Q.S / P.C	PRICE / €
SP119.AG	ancient grey / grigio antico	•	€ 177
SP119.BRO	bronze / bronzo		€ 177
SP119.BS	ivory white / bianco perla	•	€ 177
SP119.ME	mint green / menta		€ 177
SP119.TC	terracotta / terracotta		€ 177

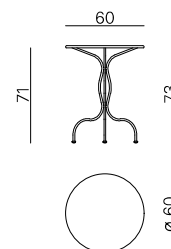



SP2130 Table / Tavolo Ø130

Galvanized steel / Acciaio zincato

Knockdown / Smontabile

Weight / Peso : 24 Kg

packaging / imballo  1  0,22  30 CM L 131 P 13 H 131

Frame / Struttura

CODE / CODICE	FRAME / STRUTTURA	Q.S / P.C	PRICE / €
SP2130.AG	ancient grey / grigio antico	•	€ 594
SP2130.BRO	bronze / bronzo		€ 594
SP2130.BS	ivory white / bianco perla	•	€ 594
SP2130.ME	mint green / menta		€ 594
SP2130.TC	terracotta / terracotta		€ 594

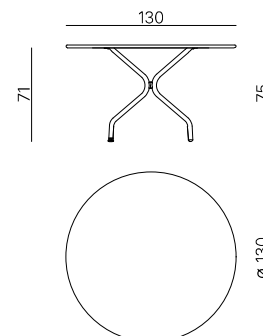



Mogan

Designed by Vermobil Team



frame / struttura

standard colours / colori standard

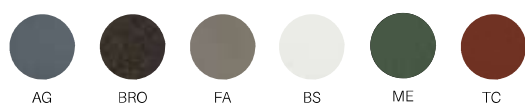

fabrics / tessuti

business

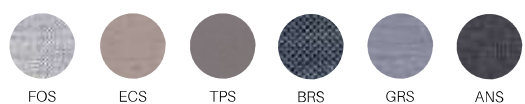

MG110 Chair / Sedia

Galvanized steel / Acciaio zincato

Stackable / Impilabile (4 pcs)

Weight / Peso : 4,2 Kg

packaging / imballo 4 0,3 19 CM L 96 P 63 H 49

Frame / Struttura

CODE / CODICE	FRAME / STRUTTURA	Q.S / P.C	PRICE / €
MG110.AG	ancient grey / grigio antico	•	€ 131
MG110.BRO	bronze / bronzo	•	€ 131
MG110.FA	mud grey / fango	•	€ 131
MG110.BS	ivory white / bianco perla	•	€ 131
MG110.ME	mint green / menta		€ 131
MG110.TC	terracotta / terracotta		€ 131

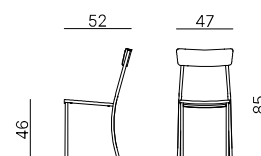



MG310 Armchair / Poltrona

Galvanized steel / Acciaio zincato

Stackable / Impilabile (4 pcs)

Weight / Peso : 7 Kg

packaging / imballo  4  0,31  30 CM L 95 P 62 H 53

Frame / Struttura

CODE / CODICE	FRAME / STRUTTURA	Q.S / P.C	PRICE / €
MG310.AG	ancient grey / grigio antico	•	€ 169
MG310.BRO	bronze / bronzo		€ 169
MG310.FA	mud grey / fango		€ 169
MG310.BS	ivory white / bianco perla		€ 169
MG310.ME	mint green / menta		€ 169
MG310.TC	terracotta / terracotta		€ 169

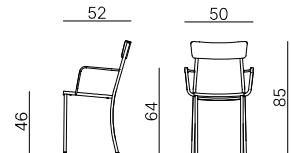

CUSMG120 Seat cushion / Cuscino seduta (for / per MG110, MG310)

Non-removable / Non sfoderabile



Anti-slip / Antiscivolo

With magnet / Con calamita

Washable / Lavabile

Waterproof gel-backing / Fodera impermeabile

Weight / Peso : 0,2 Kg

packaging / imballo  1  0,01  0,4 CM L 42 P 40 H 3

Cushion fabric set / Tessuti set cuscineria

CODE / CODICE	BUSINESS	Q.S / P.C	PRICE
CUSMG120.FOS	fossil	•	€ 45
CUSMG120.ECS	ecru		€ 45
CUSMG120.TPS	taupe		€ 45
CUSMG120.BRS	brisa		€ 45
CUSMG120.GRS	grey		€ 45
CUSMG120.ANS	anthracite		€ 45

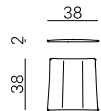



MG904 Table base / Base tavolo

Galvanized steel / Acciaio zincato

Knockdown / Smontabile

Tabletops / Piani tavolo pag. 162

Weight / Peso : 13 Kg

packaging / imballo  1  0,06  16 CM L 60 P 60 H 18

Frame / Struttura

CODE / CODICE	FRAME / STRUTTURA	Q.S / P.C	PRICE / €
MG904.AG	ancient grey / grigio antico	•	€ 212
MG904.BRO	bronze / bronzo		€ 212
MG904.FA	mud grey / fango		€ 212
MG904.BS	ivory white / bianco perla		€ 212
MG904.ME	mint green / menta		€ 212
MG904.TC	terracotta / terracotta		€ 212

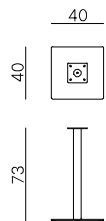

Néa

Designed by Andrea Radice



frame / struttura

standard colours / colori standard

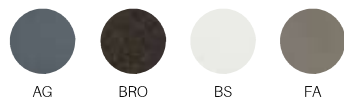

HPL

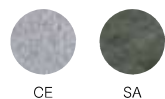

fabrics / tessuti

business

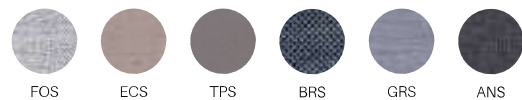

sunset

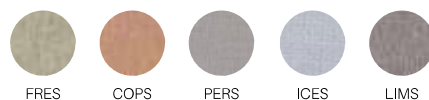

avant-garde



rope / corda





Pillow Pag. 174

More information on colors and fabrics from page 194 / Più informazioni su colori e tessuti da pagina 194

SEDNE600 Seat module / Modulo seduta

Galvanized steel / Acciaio zincato

Weight / Peso : 9,5 Kg

packaging / imballo  1  0,14  11 CM L 86 P 86 H 19

Frame / Struttura

CODE / CODICE	FRAME / STRUTTURA	Q.S / P.C	PRICE / €
SEDNE600.AG	ancient grey / grigio antico	•	€ 269
SEDNE600.BS	ivory white / bianco perla		€ 269
SEDNE600.BRO	bronze / bronzo		€ 269
SEDNE600.FA	mud grey / fango	•	€ 269

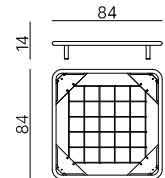



SCHNE60X Backrest and armrest module / Modulo schienale e bracciolo

Galvanized steel / Acciaio zincato

Mountable on seat module / Montabile sul modulo seduta - cod. SEDNE600

Weight / Peso : 5 Kg

packaging / imballo  1  0,19  7 CM L 85 P 70 H 31

Frame / Struttura

CODE / CODICE	FRAME / STRUTTURA	ROPE / CORDA	Q.S / P.C	PRICE / €
SCHNE609.AG	ancient grey / grigio antico	taupe / talpa		€ 221
SCHNE605.AG	ancient grey / grigio antico	black / nero		€ 221
SCHNE604.AG	ancient grey / grigio antico	mud grey / fango	•	€ 221
SCHNE604.BS	ivory white / bianco perla	mud grey / fango		€ 221
SCHNE609.BRO	bronze / bronzo	taupe / talpa		€ 221
SCHNE604.FA	mud grey / fango	mud grey / fango	•	€ 221

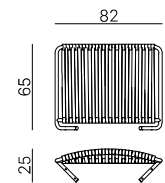

CUSNE600 Seat cushion / Cuscino seduta



Removable Cushion / Cuscino sfoderabile

Anti-slip / Antiscivolo

Washable / Lavabile

Waterproof gel-backing / Fodera impermeabile

Weight / Peso : 6 Kg

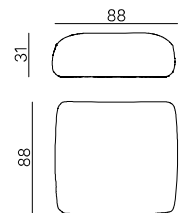
packaging / imballo  1  0,26  7 CM L 89 P 89 H 32

Cushion fabric set / Tessuti set cuscineria



CODE / CODICE	BUSINESS	Q.S / P.C	PRICE	CODE / CODICE	SUNSET	Q.S / P.C	PRICE	CODE / CODICE	AVANT GARDE	Q.S / P.C	PRICE
CUSNE600.FOS	fossil	•	€ 366	CUSNE600.FRES	fresh		€ 428	CUSNE600.CSS	cream star		€ 435
CUSNE600.ECS	ecru		€ 366	CUSNE600.COPS	copper		€ 428	CUSNE600.FSS	mud grey star		€ 435
CUSNE600.TPS	taupe		€ 366	CUSNE600.PERS	pergamino		€ 428	CUSNE600.WSS	white star		€ 435
CUSNE600.BRS	brisa		€ 366	CUSNE600.ICES	ice		€ 428				
CUSNE600.GRS	grey		€ 366	CUSNE600.LIMS	limestone		€ 428				
CUSNE600.ANS	anthracite		€ 366								

Néa

CUBNE600 Back cushion / Cuscino schienale

Removable Cushion / Cuscino sfoderabile
Washable / Lavabile

Waterproof gel-backing / Fodera impermeabile
Weight / Peso : 2 Kg

packaging / imballo  1  0,11  2,5 CM L 91 P 45 H 25

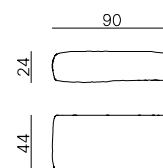



Cushion fabric set / Tessuti set cuscineria

CODE / CODICE	BUSINESS	Q.S / P.C	PRICE	CODE / CODICE	SUNSET	Q.S / P.C	PRICE	CODE / CODICE	AVANT GARDE	Q.S / P.C	PRICE
CUBNE600.FOS	fossil	•	€ 249	CUBNE600.FRES	fresh		€ 298	CUBNE600.CSS	cream star		€ 335
CUBNE600.ECS	ecru		€ 249	CUBNE600.COPS	copper		€ 298	CUBNE600.FSS	mud grey star		€ 335
CUBNE600.TPS	taupe		€ 249	CUBNE600.PERS	pergamino		€ 298	CUBNE600.WSS	white star		€ 335
CUBNE600.BRS	brisa		€ 249	CUBNE600.ICES	ice		€ 298				
CUBNE600.GRS	grey		€ 249	CUBNE600.LIMS	limestone		€ 298				
CUBNE600.ANS	anthracite		€ 249								

CUNE602 Armrest cushion / Cuscino bracciolo

Also useable on corner module / Utilizzabile anche per modulo angolare
Removable Cushion / Cuscino sfoderabile
Washable / Lavabile

Waterproof gel-backing / Fodera impermeabile
Weight / Peso : 15 Kg

packaging / imballo  1  0,88  2 CM L 70 P 45 H 25



Cushion fabric set / Tessuti set cuscineria

CODE / CODICE	BUSINESS	Q.S / P.C	PRICE	CODE / CODICE	SUNSET	Q.S / P.C	PRICE	CODE / CODICE	AVANT GARDE	Q.S / P.C	PRICE
CUNE602.FOS	fossil	•	€ 211	CUNE602.FRES	fresh		€ 252	CUNE602.CSS	cream star		€ 275
CUNE602.ECS	ecru		€ 211	CUNE602.COPS	copper		€ 252	CUNE602.FSS	mud grey star		€ 275
CUNE602.TPS	taupe		€ 211	CUNE602.PERS	pergamino		€ 252	CUNE602.WSS	white star		€ 275
CUNE602.BRS	brisa		€ 211	CUNE602.ICES	ice		€ 252				
CUNE602.GRS	grey		€ 211	CUNE602.LIMS	limestone		€ 252				
CUNE602.ANS	anthracite		€ 211								

PHPLNE200 Low Tabletop module / Modulo piano tavolo basso

High pressure laminated / Laminato ad alta pressione (HPL)
Thickness / Spessore 10mm

Mountable on seat module / Montabile sul modulo seduta - cod. SEDNE600
Weight / Peso : 9 Kg

packaging / imballo  1  0,02  10 CM L 80 P 80 H 3

Frame / Struttura

CODE / CODICE	HPL	Q.S / P.C	PRICE / €
PHPLNE200.CE	ash grey / cenere	•	€ 362
PHPLNE200.SA	samoa	•	€ 362

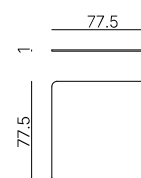

LOUNGE / POLTRONA BASSA

1x SEDNE600 + 3x SCHNE60X+ 1x CUSNE600 + 1x CUBNE600

TOTAL PRICE WITH BUSINESS CUSHIONS / PREZZO TOTALE CON CUSCINI BUSINESS	€ 1.547
TOTAL PRICE WITH SUNSET CUSHIONS / PREZZO TOTALE CON CUSCINI SUNSET	€ 1.658
TOTAL PRICE WITH AVANT-GARDE CUSHIONS / PREZZO TOTALE CON CUSCINI AVANT-GARDE	€ 1.702

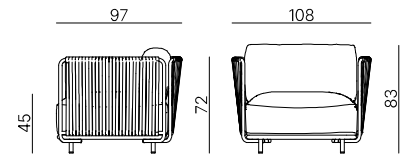
**CORNER MODULE / MODULO ANGOLARE**

1x SEDNE600 + 2x SCHNE60X + 1x CUSNE600 + 1x CUBNE600

The corner composition requires the addition of CUNE602
 La composizione angolare richiede l'aggiunta di CUNE602

TOTAL PRICE WITH BUSINESS CUSHIONS / PREZZO TOTALE CON CUSCINI BUSINESS	€ 1.326
TOTAL PRICE WITH SUNSET CUSHIONS / PREZZO TOTALE CON CUSCINI SUNSET	€ 1.437
TOTAL PRICE WITH AVANT-GARDE CUSHIONS / PREZZO TOTALE CON CUSCINI AVANT-GARDE	€ 1.481

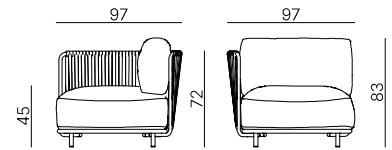
**CENTRAL MODULE / MODULO CENTRALE**

1x SEDNE600 + 1x SCHNE60X + 1x CUSNE600 + 1x CUBNE600

TOTAL PRICE WITH BUSINESS CUSHIONS / PREZZO TOTALE CON CUSCINI BUSINESS	€ 1.105
TOTAL PRICE WITH SUNSET CUSHIONS / PREZZO TOTALE CON CUSCINI SUNSET	€ 1.216
TOTAL PRICE WITH AVANT-GARDE CUSHIONS / PREZZO TOTALE CON CUSCINI AVANT-GARDE	€ 1.260

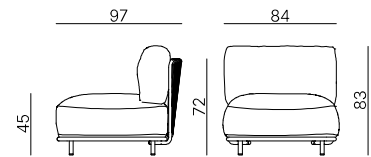
**POUF**

1x SEDNE600 + 1x CUSNE600

TOTAL PRICE WITH BUSINESS CUSHIONS / PREZZO TOTALE CON CUSCINI BUSINESS	€ 635
TOTAL PRICE WITH SUNSET CUSHIONS / PREZZO TOTALE CON CUSCINI SUNSET	€ 697
TOTAL PRICE WITH AVANT-GARDE CUSHIONS / PREZZO TOTALE CON CUSCINI AVANT-GARDE	€ 704

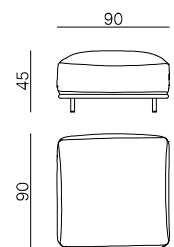
**COFFEE TABLE / TAVOLO BASSO**

1x SEDNE600 + 1x PHPLNE200

TOTAL PRICE WITH HPL / PREZZO TOTALE CON HPL	€ 631
--	-------

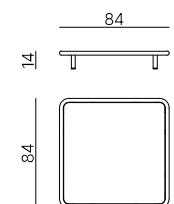

Nina

Designed by Studio Zetass



frame / struttura

standard colours / colori standard

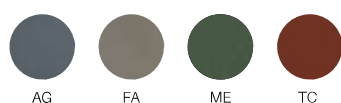

NN100 Chair / Sedia

Galvanized steel / Acciaio zincato
Polypropylene seat and backrest / Seduta e schienale in Polipropilene

Stackable / Impilabile (6 pcs)
Weight / Peso : 5,5 Kg

packaging / imballo 8 0,52 47 CM L 113 P 78 H 59

Frame / Struttura

CODE / CODICE	FRAME / STRUTTURA	POLYPROPYLENE / POLIPROPILENE	Q.S / P.C	PRICE / €
NN100.AG/AG	ancient grey / grigio antico	ancient grey / grigio antico	•	€ 125
NN100.FA/FA	mud grey / fango	mud grey / fango		€ 125
NN100.ME/ME	mint green / menta	mint green / menta		€ 125
NN100.TC/TC	terracotta / terracotta	terracotta / terracotta		€ 125

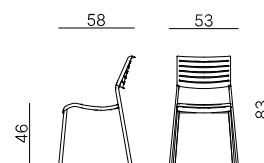

NN300 Armchair / Poltrona

Galvanized steel / Acciaio zincato
Polypropylene seat and backrest / Seduta e schienale in Polipropilene

Stackable / Impilabile (6 pcs)
Weight / Peso : 6,5 Kg

packaging / imballo 4 0,43 29 CM L 100 P 71 H 60

Frame / Struttura

CODE / CODICE	FRAME / STRUTTURA	POLYPROPYLENE / POLIPROPILENE	Q.S / P.C	PRICE / €
NN300.AG/AG	ancient grey / grigio antico	ancient grey / grigio antico	•	€ 148
NN300.FA/FA	mud grey / fango	mud grey / fango		€ 148
NN300.ME/ME	mint green / menta	mint green / menta		€ 148
NN300.TC/TC	terracotta / terracotta	terracotta / terracotta		€ 148

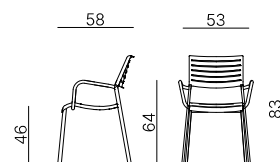

Park

Designed by Vermobil Team



frame / struttura

standard colours / colori standard



back and seat batyline / batyline seduta e schienale

basic

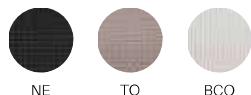

CH381 Sunbed / Lettino

Galvanized steel and Aluminium / Acciaio zincato e alluminio
Batyline fabric / Tessuto Batyline

Stackable / Impilabile (10 pcs)
Weight / Peso : 14 Kg

packaging / imballo 2 0,85 32 CM L 185 P 71 H 65

Frame / Struttura

CODE / CODICE	FRAME / STRUTTURA	BATYLINE	Q.S / P.C	PRICE / €
CH381.AG/NE	ancient grey / grigio antico	black / nero		€ 523
CH381.FA/TO	mud grey / fango	taupe / tortora		€ 523
CH381.BS/BCO	ivory white / bianco perla	white / bianco		€ 523

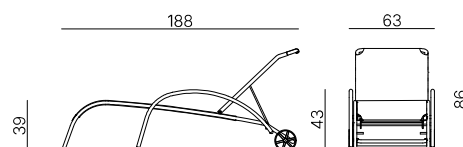

CH501 Deckchair / Sdraio

Galvanized steel / Acciaio zincato
Foldable / Pieghevole

Batyline fabric / Tessuto Batyline
Weight / Peso : 7,6 Kg

packaging / imballo 2 0,3 18 CM L 136 P 32 H 67

CODE / CODICE	FRAME / STRUTTURA	BATYLINE	Q.S / P.C	PRICE / €
CH501.AG/NE	ancient grey / grigio antico	black / nero		€ 290
CH501.FA/TO	mud grey / fango	taupe / tortora		€ 290
CH501.BS/BCO	ivory white / bianco perla	white / bianco		€ 290

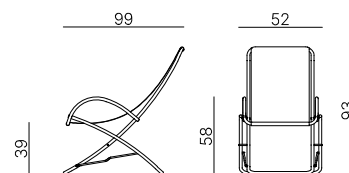

Quatris

Designed by Vermobil Team



frame / struttura

standard colours / colori standard



AG

BRO

FA

BS

ME

TC

BCU







CO

More information on colors and fabrics from page 194 / Più informazioni su colori e tessuti da pagina 194

QT6060 Table / Tavolo 60×60

Galvanized steel / Acciaio zincato
Self-leveling / Autolivellante

Stackable / Impilabile (8 pcs)
Weight / Peso : 11 Kg

packaging / imballo  8  1  94 CM L 90 P 90 H 124  16  1,30  182 CM L 90 P 90 H 160

Frame / Struttura

CODE / CODICE	FRAME / STRUTTURA	Q.S / P.C	PRICE / €
QT6060.AG	ancient grey / grigio antico	•	€ 180
QT6060.BRO	bronze / bronzo	•	€ 180
QT6060.FA	mud grey / fango	•	€ 180
QT6060.BS	ivory white / bianco perla	•	€ 180
QT6060.ME	mint green / menta		€ 180
QT6060.TC	terracotta / terracotta		€ 180
QT6060.BCU	matt white / bianco goffrato		€ 180
QT6060.CO	corten / corten		€ 180

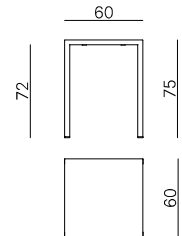

QT6060H High table / Tavolo 60×60xH110

Galvanized steel / Acciaio zincato
Self-leveling / Autolivellante

Stackable / Impilabile (8 pcs)
Weight / Peso : 13,5 Kg

packaging / imballo  8  1,26  116 CM L 90 P 90 H 155

Frame / Struttura

CODE / CODICE	FRAME / STRUTTURA	Q.S / P.C	PRICE / €
QT6060H.AG	ancient grey / grigio antico	•	€ 218
QT6060H.BRO	bronze / bronzo	•	€ 218
QT6060H.FA	mud grey / fango	•	€ 218
QT6060H.BS	ivory white / bianco perla	•	€ 218
QT6060H.ME	mint green / menta		€ 218
QT6060H.TC	terracotta / terracotta		€ 218
QT6060H.BCU	matt white / bianco goffrato		€ 218
QT6060H.CO	corten / corten		€ 218

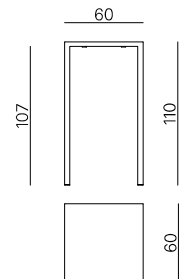





Quatris

QT7070 Table / Tavolo 70×70

Galvanized steel / Acciaio zincato
Self-leveling / Autolivellante

Stackable / Impilabile (8 pcs)
Weight / Peso : 13 Kg

packaging / imballo  8  1,39  112 CM L 106 P 106 H 124  16  2,19  216 CM L 106 P 106 H 195

Frame / Struttura

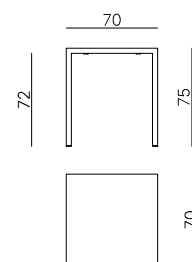

CODE / CODICE	FRAME / STRUTTURA	Q.S / P.C	PRICE / €
QT7070.AG	ancient grey / grigio antico	•	€ 200
QT7070.BRO	bronze / bronzo	•	€ 200
QT7070.FA	mud grey / fango	•	€ 200
QT7070.BS	ivory white / bianco perla	•	€ 200
QT7070.ME	mint green / menta		€ 200
QT7070.TC	terracotta / terracotta		€ 200
QT7070.BCU	matt white / bianco goffrato		€ 200
QT7070.CO	corten / corten		€ 200



QT7070H High table / Tavolo 70×70xH110

Galvanized steel / Acciaio zincato
Self-leveling / Autolivellante

Stackable / Impilabile (8 pcs)
Weight / Peso : 14 Kg

packaging / imballo  8  1,74  119 CM L 106 P 106 H 155

Frame / Struttura



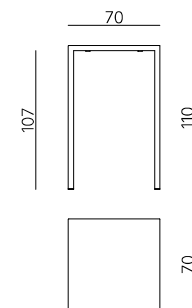



CODE / CODICE	FRAME / STRUTTURA	Q.S / P.C	PRICE / €
QT7070H.AG	ancient grey / grigio antico	•	€ 266
QT7070H.BRO	bronze / bronzo	•	€ 266
QT7070H.FA	mud grey / fango	•	€ 266
QT7070H.BS	ivory white / bianco perla	•	€ 266
QT7070H.ME	mint green / menta		€ 266
QT7070H.TC	terracotta / terracotta		€ 266
QT7070H.BCU	matt white / bianco goffrato		€ 266
QT7070H.CO	corten / corten		€ 266



QT8080 Table / Tavolo 80×80

Galvanized steel / Acciaio zincato
Self-leveling / Autolivellante

Stackable / Impilabile (8 pcs)
Weight / Peso : 15 Kg

packaging / imballo  8  1,73  110 CM L 118 P 118 H 124  16  2,62  250 CM L 118 P 118 H 188

Frame / Struttura



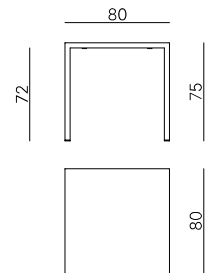

CODE / CODICE	FRAME / STRUTTURA	Q.S / P.C	PRICE / €
QT8080.AG	ancient grey / grigio antico	•	€ 207
QT8080.BRO	bronze / bronzo	•	€ 207
QT8080.FA	mud grey / fango	•	€ 207
QT8080.BS	ivory white / bianco perla	•	€ 207
QT8080.ME	mint green / menta		€ 207
QT8080.TC	terracotta / terracotta		€ 207
QT8080.BCU	matt white / bianco goffrato		€ 207
QT8080.CO	corten / corten		€ 207



QT8060 Table / Tavolo 80×60

Galvanized steel / Acciaio zincato
Self-leveling / Autolivellante

Stackable / Impilabile (8 pcs)
Weight / Peso : 10 Kg

packaging / imballo  8  1,73  89 CM L 118 P 118 H 124  12  2,62  169 CM L 118 P 118 H 160

Frame / Struttura

CODE / CODICE	FRAME / STRUTTURA	Q.S / P.C	PRICE / €
QT8060.AG	ancient grey / grigio antico	•	€ 218
QT8060.BRO	bronze / bronzo	•	€ 218
QT8060.FA	mud grey / fango	•	€ 218
QT8060.BS	ivory white / bianco perla	•	€ 218
QT8060.ME	mint green / menta		€ 218
QT8060.TC	terracotta / terracotta		€ 218
QT8060.BCU	matt white / bianco goffrato		€ 218
QT8060.CO	corten / corten		€ 218

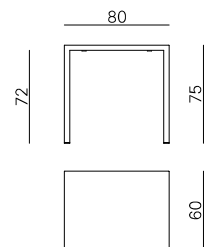







Quatris

QT9090 Table / Tavolo 90×90

Galvanized steel / Acciaio zincato
Self-leveling / Autolivellante

Stackable / Impilabile (8 pcs)
Weight / Peso : 21 Kg

packaging / imballo  8  2,03  198 CM L 128 P 128 H 124  16  2,66  346 CM L 128 P 128 H 188

Frame / Struttura

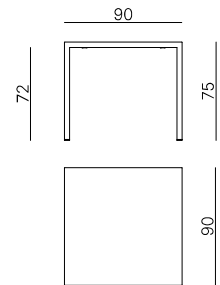

CODE / CODICE	FRAME / STRUTTURA	Q.S / P.C	PRICE / €
QT9090.AG	ancient grey / grigio antico	•	€ 293
QT9090.BRO	bronze / bronzo	•	€ 293
QT9090.FA	mud grey / fango	•	€ 293
QT9090.BS	ivory white / bianco perla	•	€ 293
QT9090.ME	mint green / menta		€ 293
QT9090.TC	terracotta / terracotta		€ 293
QT9090.BCU	matt white / bianco goffrato		€ 293
QT9090.CO	corten / corten		€ 293



QT12070 Table / Tavolo 120×70

Galvanized steel / Acciaio zincato
Self-leveling / Autolivellante

Knockdown / Smontabile
Weight / Peso : 21 Kg

packaging / imballo  1  0,14  25 CM L 129 P 80 H 13

Frame / Struttura

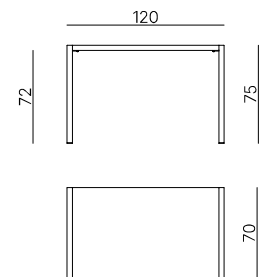

CODE / CODICE	FRAME / STRUTTURA	Q.S / P.C	PRICE / €
QT12070.AG	ancient grey / grigio antico	•	€ 384
QT12070.BRO	bronze / bronzo		€ 384
QT12070.FA	mud grey / fango		€ 384
QT12070.BS	ivory white / bianco perla	•	€ 384
QT12070.ME	mint green / menta		€ 384
QT12070.TC	terracotta / terracotta		€ 384
QT12070.BCU	matt white / bianco goffrato		€ 384
QT12070.CO	corten / corten		€ 384



QT12080 Table / Tavolo 120×80

Galvanized steel / Acciaio zincato
Self-leveling / Autolivellante

Knockdown / Smontabile
Weight / Peso : 22 Kg

packaging / imballo  1  0,15  29 CM L 129 P 89 H 13

Frame / Struttura

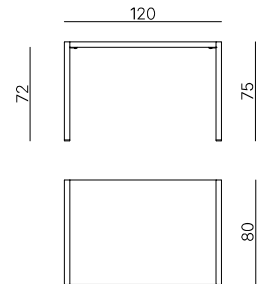

CODE / CODICE	FRAME / STRUTTURA	Q.S / P.C	PRICE / €
QT12080.AG	ancient grey / grigio antico	•	€ 407
QT12080.BRO	bronze / bronzo		€ 407
QT12080.FA	mud grey / fango		€ 407
QT12080.BS	ivory white / bianco perla	•	€ 407
QT12080.ME	mint green / menta		€ 407
QT12080.TC	terracotta / terracotta		€ 407
QT12080.BCU	matt white / bianco goffrato		€ 407
QT12080.CO	corten / corten		€ 407



QT14080 Table / Tavolo 140×80

Galvanized steel / Acciaio zincato
Self-leveling / Autolivellante

Knockdown / Smontabile
Weight / Peso : 26 Kg

packaging / imballo  1  0,19  30 CM L 157 P 91 H 13

Frame / Struttura

CODE / CODICE	FRAME / STRUTTURA	Q.S / P.C	PRICE / €
QT14080.AG	ancient grey / grigio antico	•	€ 520
QT14080.BRO	bronze / bronzo		€ 520
QT14080.FA	mud grey / fango		€ 520
QT14080.BS	ivory white / bianco perla	•	€ 520
QT14080.ME	mint green / menta		€ 520
QT14080.TC	terracotta / terracotta		€ 520
QT14080.BCU	matt white / bianco goffrato		€ 520
QT14080.CO	corten / corten		€ 520

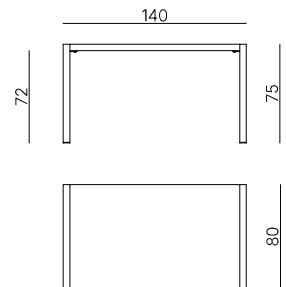



Quatris

QT16080 Table / Tavolo 160×80

Galvanized steel / Acciaio zincato
Self-leveling / Autolivellante

Knockdown / Smontabile
Weight / Peso : 28 Kg

packaging / imballo  1  0,20  32 CM L 166 P 91 H 13

Frame / Struttura

CODE / CODICE	FRAME / STRUTTURA	Q.S / P.C	PRICE / €
QT16080.AG	ancient grey / grigio antico	•	€ 545
QT16080.BRO	bronze / bronzo		€ 545
QT16080.FA	mud grey / fango		€ 545
QT16080.BS	ivory white / bianco perla	•	€ 545
QT16080.ME	mint green / menta		€ 545
QT16080.TC	terracotta / terracotta		€ 545
QT16080.BCU	matt white / bianco goffrato		€ 545
QT16080.CO	corten / corten		€ 545

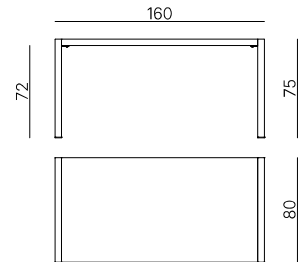

QT20080 Table / Tavolo 200×80

Galvanized steel / Acciaio zincato
Self-leveling / Autolivellante

Knockdown / Smontabile
Weight / Peso : 32 Kg

packaging / imballo  1  0,25  38 CM L 209 P 92 H 13

Frame / Struttura

CODE / CODICE	FRAME / STRUTTURA	Q.S / P.C	PRICE / €
QT20080.AG	ancient grey / grigio antico	•	€ 611
QT20080.BRO	bronze / bronzo		€ 611
QT20080.FA	mud grey / fango		€ 611
QT20080.BS	ivory white / bianco perla	•	€ 611
QT20080.ME	mint green / menta		€ 611
QT20080.TC	terracotta / terracotta		€ 611
QT20080.BCU	matt white / bianco goffrato		€ 611
QT20080.CO	corten / corten		€ 611

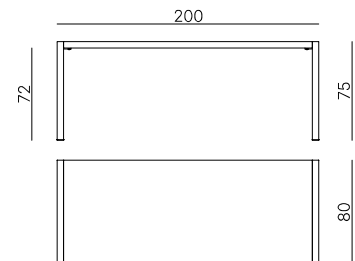

QT151 Stool / Sgabello 32×32

Galvanized steel / Acciaio zincato
Self-leveling / Autolivellante

Stackable / Impilabile (8 pcs)
Weight / Peso : 4 Kg

packaging / imballo  1  0,06  5 CM L 50 P 36 H 35

Frame / Struttura

CODE / CODICE	FRAME / STRUTTURA	Q.S / P.C	PRICE / €
QT151.AG	ancient grey / grigio antico	•	€ 97
QT151.BRO	bronze / bronzo		€ 97
QT151.FA	mud grey / fango		€ 97
QT151.BS	ivory white / bianco perla	•	€ 97
QT151.ME	mint green / menta		€ 97
QT151.TC	terracotta / terracotta		€ 97
QT151.BCU	matt white / bianco goffrato		€ 97
QT151.CO	corten / corten		€ 97

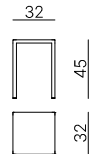

QT154 Stool / Sgabello 40×40

Galvanized steel / Acciaio zincato
Self-leveling / Autolivellante

Stackable / Impilabile (8 pcs)
Weight / Peso : 5 Kg

packaging / imballo  1  0,09  6 CM L 47 P 44 H 43

Frame / Struttura

CODE / CODICE	FRAME / STRUTTURA	Q.S / P.C	PRICE / €
QT154.AG	ancient grey / grigio antico	•	€ 105
QT154.BRO	bronze / bronzo		€ 105
QT154.FA	mud grey / fango		€ 105
QT154.BS	ivory white / bianco perla	•	€ 105
QT154.ME	mint green / menta		€ 105
QT154.TC	terracotta / terracotta		€ 105
QT154.BCU	matt white / bianco goffrato		€ 105
QT154.CO	corten / corten		€ 105

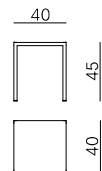

Roma

Designed by Vermobil Team



frame / struttura

standard colours / colori standard



AG BRO CO

fabrics / tessuti

business



FOS ECS TPS BRS GRS ANS



Pillow Pag. 174



More information on colors and fabrics from page 194 / Più informazioni su colori e tessuti da pagina 194

RM100 Chair / Sedia

Galvanized steel / Acciaio zincato

Stackable / Impilabile (8 pcs)

Weight / Peso : 5 Kg

packaging / imballo  4  0,32  24 CM L 95 P 65 H 52

Frame / Struttura

CODE / CODICE	FRAME / STRUTTURA	Q.S / P.C	PRICE / €
RM100.AG	ancient grey / grigio antico	•	€ 141
RM100.BRO	bronze / bronzo		€ 141
RM100.CO	corten / corten		€ 141

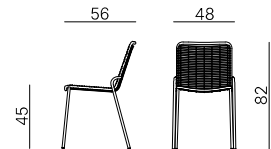



RM300 Armchair / Poltrona

Galvanized steel / Acciaio zincato

Stackable / Impilabile (8 pcs)

Weight / Peso : 6 Kg

packaging / imballo  2  0,33  15 CM L 94 P 61 H 58

Frame / Struttura

CODE / CODICE	FRAME / STRUTTURA	Q.S / P.C	PRICE / €
RM300.AG	ancient grey / grigio antico	•	€ 165
RM300.BRO	bronze / bronzo		€ 165
RM300.CO	corten / corten		€ 165

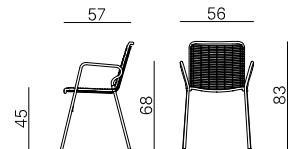

CUSRM100 Seat cushion / Cuscino seduta (for / per RM100, RM300)

Non-removable / Non sfoderabile



Anti-slip / Antiscivolo

With magnet / Con calamita

Washable / Lavabile

Waterproof gel-backing / Fodera impermeabile

Weight / Peso : 0,2 Kg

packaging / imballo  1  0,01  0,4 CM L 42 P 40 H 3

Cushion fabric set / Tessuti set cuscineria

CODE / CODICE	BUSINESS	Q.S / P.C	PRICE
CUSRM100.FOS	fossil	•	€ 45
CUSRM100.ECS	ecru		€ 45
CUSRM100.TPS	taupe		€ 45
CUSRM100.BRS	brisa		€ 45
CUSRM100.GRS	grey		€ 45
CUSRM100.ANS	anthracite		€ 45

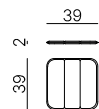



Roma

RM150 Barstool / Sgabello

Galvanized steel / Acciaio zincato

Stackable / Impilabile (8 pcs)

Weight / Peso : 6,5 Kg

packaging / imballo  2  0,31  17 CM L 104 P 58 H 52

Frame / Struttura

CODE / CODICE	FRAME / STRUTTURA	Q.S / P.C	PRICE / €
RM150.AG	ancient grey / grigio antico	•	€ 213
RM150.BRO	bronze / bronzo		€ 213
RM150.CO	corten / corten		€ 213

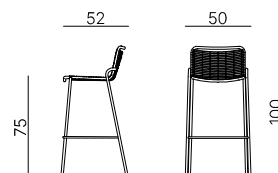

CUSRM150 Seat cushion / Cuscino seduta (for / per RM150)

Non-removable / Non sfoderabile

Anti-slip / Antiscivolo

With magnet / Con calamita

Washable / Lavabile

Waterproof gel-backing / Fodera impermeabile

Weight / Peso : 0,2 Kg

packaging / imballo  1  0,01  0,4 CM L 39 P 42 H 3

Cushion fabric set / Tessuti set cuscineria

CODE / CODICE	BUSINESS	Q.S / P.C	PRICE
CUSRM150.FOS	fossil	•	€ 40
CUSRM150.ECS	ecru		€ 40
CUSRM150.TPS	taupe		€ 40
CUSRM150.BRS	brisa		€ 40
CUSRM150.GRS	grey		€ 40
CUSRM150.ANS	anthracite		€ 40



RM9090 Table / Tavolo 90×90

Galvanized steel / Acciaio zincato

Knockdown / Smontabile

Weight / Peso : 17 Kg

packaging / imballo  1  0,08  20 CM L 97 P 97 H 9

Frame / Struttura

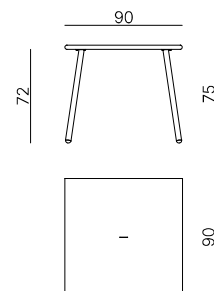

CODE / CODICE	FRAME / STRUTTURA	Q.S / P.C	PRICE / €
RM9090.AG	ancient grey / grigio antico	•	€ 574
RM9090.BRO	bronze / bronzo		€ 574
RM9090.CO	corten / corten		€ 574



RM19090 Table / Tavolo 190×90

Galvanized steel / Acciaio zincato

Knockdown / Smontabile

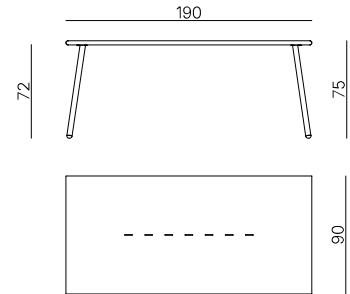

Weight / Peso : 28 Kgpackaging / imballo  1  0,23  32 CM L 197 P 97 H 12**Frame / Struttura**

CODE / CODICE	FRAME / STRUTTURA	Q.S / P.C	PRICE / €
RM19090.AG	ancient grey / grigio antico	•	€ 837
RM19090.BRO	bronze / bronzo		€ 837
RM19090.CO	corten / corten		€ 837

**RM220100 Table / Tavolo 220×100**

Galvanized steel / Acciaio zincato

Knockdown / Smontabile

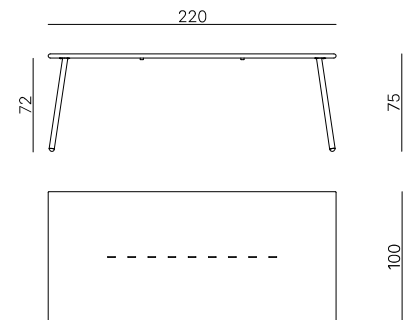

Weight / Peso : 43 Kgpackaging / imballo  1  0,29  47 CM L 227 P 107 H 12**Frame / Struttura**

CODE / CODICE	FRAME / STRUTTURA	Q.S / P.C	PRICE / €
RM220100.AG	ancient grey / grigio antico	•	€ 1.136
RM220100.BRO	bronze / bronzo		€ 1.136
RM220100.CO	corten / corten		€ 1.136

**RM1300 Table / Tavolo ø 130**

Galvanized steel / Acciaio zincato

Knockdown / Smontabile

Weight / Peso : 23 Kgpackaging / imballo  1  0,21  30 CM L 132 P 132 H 12**Frame / Struttura**

CODE / CODICE	FRAME / STRUTTURA	Q.S / P.C	PRICE / €
RM1300.AG	ancient grey / grigio antico	•	€ 732
RM1300.BRO	bronze / bronzo		€ 732
RM1300.CO	corten / corten		€ 732

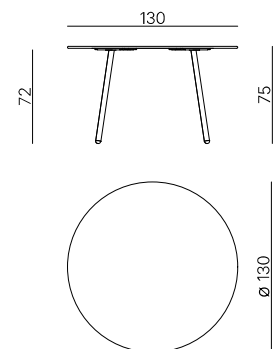



Roma

RM660 Lounge / Poltrona bassa

Galvanized steel / Acciaio zincato

Stackable / Impilabile (4 pcs)

Weight / Peso : 10 Kg

packaging / imballo  1  0,42  13 CM L 79 P 71 H 74

Frame / Struttura

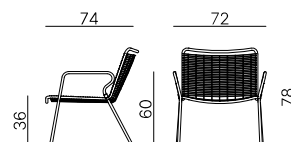

CODE / CODICE	FRAME / STRUTTURA	Q.S / P.C	PRICE / €
RM660.AG	ancient grey / grigio antico	•	€ 246
RM660.BRO	bronze / bronzo		€ 246
RM660.CO	corten / corten		€ 246



RM620 Rocking lounge chair / Poltrona a dondolo

Galvanized steel / Acciaio zincato

Weight / Peso : 14 Kg

packaging / imballo  1  0,48  17 CM L 83 P 73 H 79

Frame / Struttura

CODE / CODICE	FRAME / STRUTTURA	Q.S / P.C	PRICE / €
RM620.AG	ancient grey / grigio antico	•	€ 336
RM620.BRO	bronze / bronzo		€ 336
RM620.CO	corten / corten		€ 336

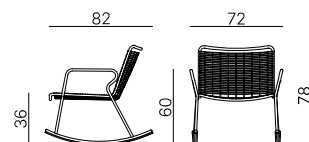

CUSRM600 Seat cushion / Cuscino seduta (for / per RM660, RM620)

Non-removable / Non sfoderabile



Anti-slip / Antiscivolo

With magnet / Con calamita

Washable / Lavabile

Waterproof gel-backing / Fodera impermeabile

Weight / Peso : 0,4 Kg

packaging / imballo  1  0,01  0,6 CM L 56 P 48 H 3

Cushion fabric set / Tessuti set cuscineria

CODE / CODICE	BUSINESS	Q.S / P.C	PRICE
CUSRM600.FOS	fossil	•	€ 54
CUSRM600.ECS	ecru		€ 54
CUSRM600.TPS	taupe		€ 54
CUSRM600.BRS	brisa		€ 54
CUSRM600.GRS	grey		€ 54
CUSRM600.ANS	anthracite		€ 54

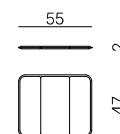



Seaside

Designed by Vermobil Team



frame / struttura

standard colours / colori standard

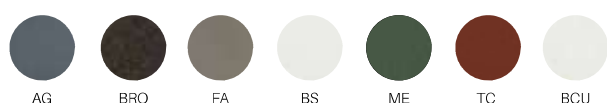

SE152 Barstool / Sgabello

Galvanized steel / Acciaio zincato

Weight / Peso : 5,8 Kg

packaging / imballo 1 0,10 7 CM L 35 P 35 H 81

Frame / Struttura

CODE / CODICE	FRAME / STRUTTURA	Q.S / P.C	PRICE / €
SE152.AG	ancient grey / grigio antico	•	€ 124
SE152.BRO	bronze / bronzo	•	€ 124
SE152.FA	mud grey / fango	•	€ 124
SE152.BS	ivory white / bianco perla	•	€ 124
SE152.ME	mint green / menta		€ 124
SE152.TC	terracotta / terracotta		€ 124
SE152.BCU	matt white / bianco goffrato		€ 124

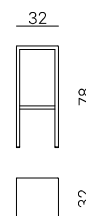

SE6060 High table / Tavolo alto 60×60xH110

Galvanized steel / Acciaio zincato

Weight / Peso : 12 Kg

packaging / imballo 1 0,47 15 CM L 114 P 64 H 64

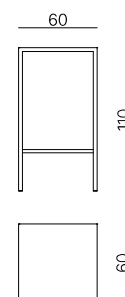

Frame / Struttura

CODE / CODICE	FRAME / STRUTTURA	Q.S / P.C	PRICE / €
SE6060.AG	ancient grey / grigio antico	•	€ 274
SE6060.BRO	bronze / bronzo	•	€ 274
SE6060.FA	mud grey / fango	•	€ 274
SE6060.BS	ivory white / bianco perla	•	€ 274
SE6060.ME	mint green / menta		€ 274
SE6060.TC	terracotta / terracotta		€ 274
SE6060.BCU	matt white / bianco goffrato		€ 274



SE7575 High table / Tavolo alto 75×75xH110



Galvanized steel / Acciaio zincato

Weight / Peso : 16 Kgpackaging / imballo  1  0,68  20 CM L 112 P 78 H 78**Frame / Struttura**

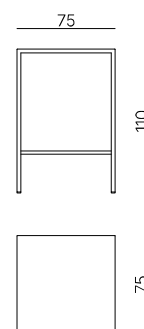
CODE / CODICE	FRAME / STRUTTURA	Q.S / P.C	PRICE / €
SE7575.AG	ancient grey / grigio antico	•	€ 353
SE7575.BRO	bronze / bronzo	•	€ 353
SE7575.FA	mud grey / fango	•	€ 353
SE7575.BS	ivory white / bianco perla	•	€ 353
SE7575.ME	mint green / menta		€ 353
SE7575.TC	terracotta / terracotta		€ 353
SE7575.BCU	matt white / bianco goffrato		€ 353

**SE10560 High table / Tavolo alto 105×60xH110**



Galvanized steel / Acciaio zincato

Weight / Peso : 17,5 Kgpackaging / imballo  1  0,76  23 CM L 108 P 62 H 114**Frame / Struttura**

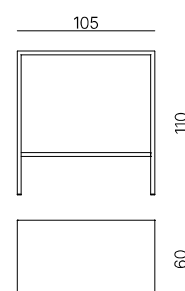
CODE / CODICE	FRAME / STRUTTURA	Q.S / P.C	PRICE / €
SE10560.AG	ancient grey / grigio antico	•	€ 394
SE10560.BRO	bronze / bronzo	•	€ 394
SE10560.FA	mud grey / fango	•	€ 394
SE10560.BS	ivory white / bianco perla	•	€ 394
SE10560.ME	mint green / menta		€ 394
SE10560.TC	terracotta / terracotta		€ 394
SE10560.BCU	matt white / bianco goffrato		€ 394

**SE6060KIT High table and barstools kit / Kit tavolo alto 60×60 H110 e sgabelli**

Galvanized steel / Acciaio zincato

1x SE6060 + 2x SE152**Weight / Peso : 24 Kg**packaging / imballo  1  0,47  28 CM L 114 P 64 H 64**Frame / Struttura**

CODE / CODICE	FRAME / STRUTTURA	Q.S / P.C	PRICE / €
SE6060KIT.AG	ancient grey / grigio antico	•	€ 452
SE6060KIT.BRO	bronze / bronzo	•	€ 452
SE6060KIT.FA	mud grey / fango	•	€ 452
SE6060KIT.BS	ivory white / bianco perla	•	€ 452
SE6060KIT.ME	mint green / menta		€ 452
SE6060KIT.TC	terracotta / terracotta		€ 452
SE6060KIT.BCU	matt white / bianco goffrato		€ 452

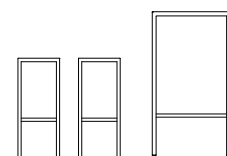

Seaside

SE7575KIT High table and barstools kit / Kit tavolo alto 75×75 H110 e sgabelli

Galvanized steel / Acciaio zincato

1x SE7575 + 4x SE152

Weight / Peso : 40 Kg

packaging / imballo  1  0,68  44 CM L 112 P 78 H 78

Frame / Struttura

CODE / CODICE	FRAME / STRUTTURA	Q.S / P.C	PRICE / €
SE7575KIT.AG	ancient grey / grigio antico	•	€ 677
SE7575KIT.BRO	bronze / bronzo	•	€ 677
SE7575KIT.FA	mud grey / fango	•	€ 677
SE7575KIT.BS	ivory white / bianco perla	•	€ 677
SE7575KIT.ME	mint green / menta		€ 677
SE7575KIT.TC	terracotta / terracotta		€ 677
SE7575KIT.BCU	matt white / bianco goffrato		€ 677

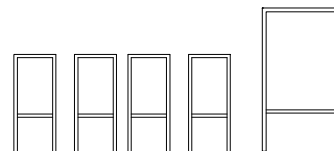



Slot

Designed by Alessandro Canepa



frame / struttura

standard colours / colori standard



fabrics / tessuti

business

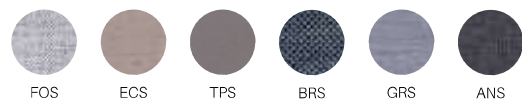

rope / corda



Pillow Pag. 174

More information on colors and fabrics from page 194 / Più informazioni su colori e tessuti da pagina 194

SL301 Armchair / Poltrona

Galvanized steel / Acciaio zincato
Weaven rope backrest / Schienale incordato

Stackable / Impilabile (8 pcs)
Weight / Peso : 6 Kg

packaging / imballo  2  0,30  14 CM L 85 P 62 H 57

Frame / Struttura

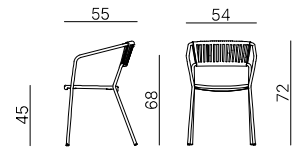

CODE / CODICE	FRAME / STRUTTURA	ROPE / CORDA	Q.S / P.C	PRICE / €
SL301.CO/FA	corten / corten	mud grey / fango		€ 246
SL301.BS/TA	ivory white / bianco perla	taupe / talpa		€ 246
SL301.AG/NE	ancient grey / grigio antico	black / nero		€ 246
SL301.FA/FA	mud grey / fango	mud grey / fango		€ 246
SL301.BRO/TA	bronze / bronzo	taupe / talpa		€ 246
SL301.AG/FA	ancient grey / grigio antico	mud grey / fango		€ 246



SL15X Barstool / Sgabello

Galvanized steel / Acciaio zincato
Weaven rope backrest / Schienale incordato

Stackable / Impilabile (4 pcs)
Weight / Peso : 7,5 Kg

packaging / imballo  1  0,37  10 CM L 104 P 61 H 58

Frame / Struttura

CODE / CODICE	FRAME / STRUTTURA	ROPE / CORDA	Q.S / P.C	PRICE / €
SL154.CO	corten / corten	mud grey / fango		€ 303
SL159.BS	ivory white / bianco perla	taupe / talpa		€ 303
SL155.AG	ancient grey / grigio antico	black / nero		€ 303
SL154.FA	mud grey / fango	mud grey / fango		€ 303
SL159.BRO	bronze / bronzo	taupe / talpa		€ 303
SL154.AG	ancient grey / grigio antico	mud grey / fango		€ 303

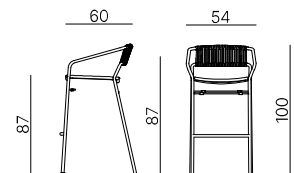

CUSRM100 Seat cushion / Cuscino seduta (for / per SL301, SL15X)

Non-removable / Non sfoderabile
Anti-slip / Antiscivolo
With magnet / Con calamita

Washable / Lavabile
Waterproof gel-backing / Fodera impermeabile
Weight / Peso : 0,2 Kg

packaging / imballo  1  0,01  0,4 CM L 42 P 40 H 3

Cushion fabric set / Tessuti set cuscineria

CODE / CODICE	BUSINESS	Q.S / P.C	PRICE
CUSRM100.FOS	fossil	•	€ 45
CUSRM100.ECS	ecru		€ 45
CUSRM100.TPS	taupe		€ 45
CUSRM100.BRS	brisa		€ 45
CUSRM100.GRS	grey		€ 45
CUSRM100.ANS	anthracite		€ 45

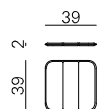

Slot

SL60X Lounge chair / Poltrona bassa

TOTAL PRICE WITH BUSINESS CUSHIONS / PREZZO TOTALE CON CUSCINI BUSINESS € 618

Galvanized steel / Acciaio zincato
Elastic strap seat and weaven rope backrest / Seduta in cinta elastica e schienale incordato
Seat cushion included / Cuscino seduta incluso
Removable Cushion / Cuscino sfoderabile

Washable / Lavabile
Waterproof gel-backing / Fodera impermeabile
Stackable / Impilabile (4 pcs)
Weight / Peso : 8 Kg

packaging / imballo  1  0,40  12 CM L 78 P 70 H 73

Frame / Struttura

CODE / CODICE	FRAME / STRUTTURA	ROPE / CORDA	Q.S / P.C	PRICE / €
SL604.CO	corten / corten	mud grey / fango		€ 501
SL609.BS	ivory white / bianco perla	taupe / talpa		€ 501
SL605.AG	ancient grey / grigio antico	black / nero		€ 501
SL604.FA	mud grey / fango	mud grey / fango		€ 501
SL609.BRO	bronze / bronzo	taupe / talpa		€ 501
SL604.AG	ancient grey / grigio antico	mud grey / fango		€ 501

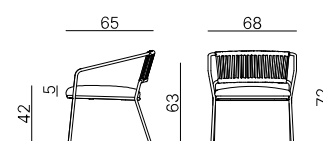

Cushion fabric set / Tessuti set cuscineria (1 seat cushion / 1 cuscino seduta)



CODE / CODICE	BUSINESS	Q.S / P.C	PRICE
CUSL600.FOS	fossil		€ 117
CUSL600.ECS	ecru		€ 117
CUSL600.TPS	taupe		€ 117
CUSL600.BRS	brisa		€ 117
CUSL600.GRS	grey		€ 117
CUSL600.ANS	anthracite		€ 117

SL63X Sofa / Divano

TOTAL PRICE WITH BUSINESS CUSHIONS / PREZZO TOTALE CON CUSCINI BUSINESS € 1.096

Galvanized steel / Acciaio zincato
Elastic strap seat and weaven rope backrest / Seduta in cinta elastica e schienale incordato
Seat cushion included / Cuscino seduta incluso
Removable Cushion / Cuscino sfoderabile

Washable / Lavabile
Waterproof gel-backing / Fodera impermeabile
Stackable / Impilabile (4 pcs)
Weight / Peso : 16 Kg

packaging / imballo  1  0,81  20 CM L 155 P 72 H 73

Frame / Struttura

CODE / CODICE	FRAME / STRUTTURA	ROPE / CORDA	Q.S / P.C	PRICE / €
SL634.CO	corten / corten	mud grey / fango		€ 907
SL639.BS	ivory white / bianco perla	taupe / talpa		€ 907
SL635.AG	ancient grey / grigio antico	black / nero		€ 907
SL634.FA	mud grey / fango	mud grey / fango		€ 907
SL639.BRO	bronze / bronzo	taupe / talpa		€ 907
SL634.AG	ancient grey / grigio antico	mud grey / fango		€ 907

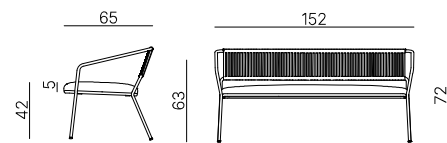

Cushion fabric set / Tessuti set cuscineria (1 seat cushion / 1 cuscino seduta)

CODE / CODICE	BUSINESS	Q.S / P.C	PRICE
CUSL630.FOS	fossil		€ 189
CUSL630.ECS	ecru		€ 189
CUSL630.TPS	taupe		€ 189
CUSL630.BRS	brisa		€ 189
CUSL630.GRS	grey		€ 189
CUSL630.ANS	anthracite		€ 189

Springtime

Designed by Vermobil Team



frame / struttura

standard colours / colori standard



AG

fabrics / tessuti

business



FOS



ECS



TPS



BRS



GRS



ANS



Pillow Pag. 174

More information on colors and fabrics from page 194 / Più informazioni su colori e tessuti da pagina 194

SP3112 Chair / Sedia

Galvanized steel / Acciaio zincato

Foldable / Pieghevole

Weight / Peso : 7 Kgpackaging / imballo  2  0,15  16,5 CM L 110 P 30 H 46**Frame / Struttura**

CODE / CODICE	FRAME / STRUTTURA	Q.S / P.C	PRICE / €
SP3112.AG	ancient grey / grigio antico	•	€ 224

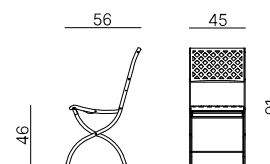
**SP3113 Armchair / Poltrona**

Galvanized steel / Acciaio zincato

Foldable / Pieghevole

Weight / Peso : 9 Kgpackaging / imballo  2  0,25  20,5 CM L 118 P 37 H 54**Frame / Struttura**

CODE / CODICE	FRAME / STRUTTURA	Q.S / P.C	PRICE / €
SP3113.AG	ancient grey / grigio antico	•	€ 271

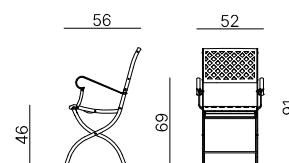
**CU113 Seat cushion / Cuscino seduta (for / per SP3112, SP3113)**

Removable Cushion / Cuscino sfoderabile

Washable / Lavabile

Waterproof gel-backing / Fodera impermeabile

Weight / Peso : 0,4 Kgpackaging / imballo  1  0,01  0,6 CM L 44 P 44 H 6**Cushion fabric set / Tessuti set cuscineria**

CODE / CODICE	BUSINESS	Q.S / P.C	PRICE
CU113.FOS	fossil	•	€ 57

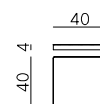
**CUSRM100 Seat cushion / Cuscino seduta (for / per SP3112, SP3113)**

Non-removable / Non sfoderabile

Anti-slip / Antiscivolo

With magnet / Con calamita

Washable / Lavabile

Waterproof gel-backing / Fodera impermeabile

Weight / Peso : 0,2 Kgpackaging / imballo  1  0,01  0,4 CM L 42 P 40 H 3**Cushion fabric set / Tessuti set cuscineria**

CODE / CODICE	BUSINESS	Q.S / P.C	PRICE
CUSRM100.FOS	fossil	•	€ 45
CUSRM100.ECS	ecru		€ 45
CUSRM100.TPS	taupe		€ 45
CUSRM100.BRS	brisa		€ 45
CUSRM100.GRS	grey		€ 45
CUSRM100.ANS	anthracite		€ 45

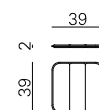



Springtime

SP3121 Table / Tavolo 160×80

Galvanized steel / Acciaio zincato

Foldable / Pieghevole

Weight / Peso : 23 Kg

packaging / imballo  1  0,40  26 CM L 162 P 103 H 24

Frame / Struttura

CODE / CODICE	FRAME / STRUTTURA	Q.S / P.C	PRICE / €
SP3121.AG	ancient grey / grigio antico	•	€ 547

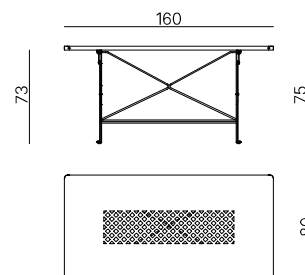



SP2130 Table / Tavolo Ø130

Galvanized steel / Acciaio zincato

Knockdown / Smontabile

Weight / Peso : 24 Kg

packaging / imballo  1  0,22  30 CM L 131 P 13 H 131

Frame / Struttura

CODE / CODICE	FRAME / STRUTTURA	Q.S / P.C	PRICE / €
SP2130.AG	ancient grey / grigio antico	•	€ 594

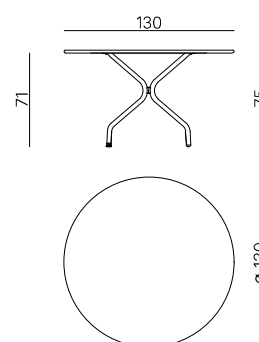

SP3130 Lounge chair / Poltrona bassa

TOTAL PRICE WITH BUSINESS CUSHIONS / PREZZO TOTALE CON CUSCINI BUSINESS € 634

Galvanized steel / Acciaio zincato

knockdown / Smontabile



Seat cushion included / Cuscino seduta incluso

Removable Cushion / Cuscino sfoderabile

Washable / Lavabile

Waterproof gel-backing / Fodera impermeabile

Weight / Peso : 21 Kg

packaging / imballo  1  0,19  23 CM L 88 P 73 H 29

Frame / Struttura

CODE / CODICE	FRAME / STRUTTURA	Q.S / P.C	PRICE / €
SP3130.AG	ancient grey / grigio antico	•	€ 505

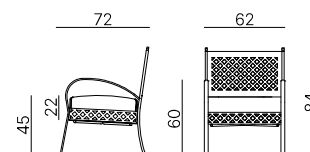



Cushion fabric set / Tessuti set cuscineria (1 seat cushion / 1 cuscino seduta)

CODE / CODICE	BUSINESS	Q.S / P.C	PRICE
CUSP3130.FOS	fossil	•	€ 129
CUSP3130.ECS	ecru		€ 129
CUSP3130.TPS	taupe		€ 129
CUSP3130.GRS	grey		€ 129
CUSP3130.ANS	anthracite		€ 129

SP3131 2 seater sofa / Divano 2 posti

TOTAL PRICE WITH BUSINESS CUSHIONS / PREZZO TOTALE CON CUSCINI BUSINESS € 957

Galvanized steel / Acciaio zincato Washable / Lavabile
 knockdown / Smontabile Waterproof gel-backing / Fodera impermeabile
 Seat cushions included / Cuscini seduta inclusi **Weight / Peso : 30 Kg**
 Removable Cushions / Cuscini sfoderabili

packaging / imballo  1  0,27  33 CM L 125 P 77 H 28

Frame / Struttura



CODE / CODICE	FRAME / STRUTTURA	Q.S / P.C	PRICE / €
SP3131.AG	ancient grey / grigio antico	•	€ 699

Cushion fabric set / Tessuti set cuscineria (2 seat cushion / 2 cuscini seduta)

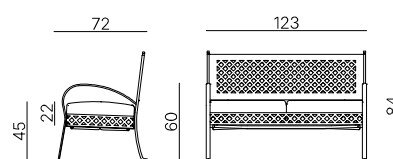
CODE / CODICE	BUSINESS	Q.S / P.C	PRICE
CUSP3131.FOS	fossil	•	€ 258
CUSP3131.ECS	ecru		€ 258
CUSP3131.TPS	taupe		€ 258
CUSP3131.GRS	grey		€ 258
CUSP3131.ANS	anthracite		€ 258

**SP3134 Coffee table / Tavolo basso 64x64**

Galvanized steel / Acciaio zincato
Weight / Peso : 8 Kg

packaging / imballo  1  0,22  10 CM L 67 P 67 H 51

Frame / Struttura

CODE / CODICE	FRAME / STRUTTURA	Q.S / P.C	PRICE / €
SP3134.AG	ancient grey / grigio antico	•	€ 298

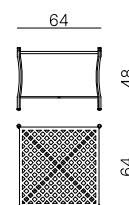

Step

Designed by Vermobil Team



frame / struttura

standard colours / colori standard



ST105 Chair / Sedia

Galvanized steel / Acciaio zincato

Foldable / Pieghevole

Weight / Peso : 6 Kg

packaging / imballo 4 0,20 27 CM L 99 P 45 H 45

Frame / Struttura

CODE / CODICE	FRAME / STRUTTURA	Q.S / P.C	PRICE / €
ST105.AG	ancient grey / grigio antico	•	€ 107
ST105.BRO	bronze / bronzo		€ 107
ST105.FA	mud grey / fango		€ 107
ST105.BS	ivory white / bianco perla		€ 107
ST105.ME	mint green / menta		€ 107
ST105.TC	terracotta / terracotta		€ 107
ST105.BCU	matt white / bianco goffrato		€ 107

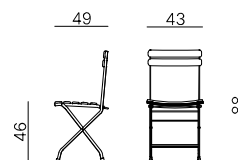



ST7050 Table / Tavolo 70×50

Galvanized steel / Acciaio zincato

Foldable / Pieghevole

Weight / Peso : 9 Kg

packaging / imballo  1  0,03  10 CM L 90 P 53 H 7

Frame / Struttura

CODE / CODICE	FRAME / STRUTTURA	Q.S / P.C	PRICE / €
ST7050.AG	ancient grey / grigio antico	•	€ 179
ST7050.BRO	bronze / bronzo		€ 179
ST7050.FA	mud grey / fango		€ 179
ST7050.BS	ivory white / bianco perla		€ 179
ST7050.ME	mint green / menta		€ 179
ST7050.TC	terracotta / terracotta		€ 179
ST7050.BCU	matt white / bianco goffrato		€ 179

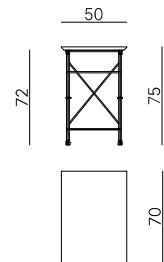



ST7070 Table / Tavolo 70×70

Galvanized steel / Acciaio zincato

Foldable / Pieghevole

Weight / Peso : 11 Kg

packaging / imballo  1  0,05  12 CM L 90 P 73 H 7

Frame / Struttura

CODE / CODICE	FRAME / STRUTTURA	Q.S / P.C	PRICE / €
ST7070.AG	ancient grey / grigio antico	•	€ 208
ST7070.BRO	bronze / bronzo		€ 208
ST7070.FA	mud grey / fango		€ 208
ST7070.BS	ivory white / bianco perla		€ 208
ST7070.ME	mint green / menta		€ 208
ST7070.TC	terracotta / terracotta		€ 208
ST7070.BCU	matt white / bianco goffrato		€ 208

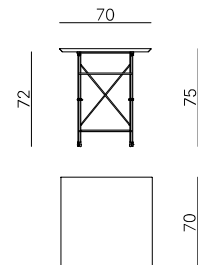

Tosca

Designed by Vermobil Team



frame / struttura

standard colours / colori standard



fabrics / tessuti

business

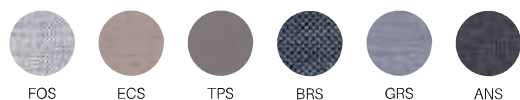

TO101 Chair / Sedia

Galvanized steel / Acciaio zincato

Stackable / Impilabile (4 pcs)

Weight / Peso : 5 Kg

packaging / imballo 4 0,43 23 CM L 124 P 72 H 48

Frame / Struttura

CODE / CODICE	FRAME / STRUTTURA	Q.S / P.C	PRICE / €
TO101.AG	ancient grey / grigio antico	•	€ 215
TO101.BRO	bronze / bronzo		€ 215
TO101.BS	ivory white / bianco perla		€ 215

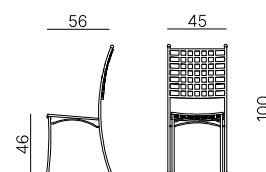

TO301 Armchair / Poltrona

Galvanized steel / Acciaio zincato

Stackable / Impilabile (4 pcs)

Weight / Peso : 6 Kg

packaging / imballo 4 0,47 30 CM L 124 P 70 H 54

Frame / Struttura

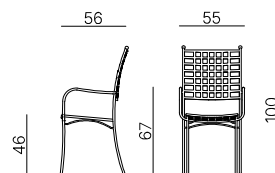

CODE / CODICE	FRAME / STRUTTURA	Q.S / P.C	PRICE / €
TO301.AG	ancient grey / grigio antico	•	€ 229
TO301.BRO	bronze / bronzo		€ 229
TO301.BS	ivory white / bianco perla		€ 229



CU113 Seat cushion / Cuscino seduta (for / per TO101, TO301)

Removable Cushion / Cuscino sfoderabile
Washable / Lavabile

Waterproof gel-backing / Fodera impermeabile
Weight / Peso : 0,4 Kg

packaging / imballo  1  0,01  0,6 CM L 44 P 44 H 6

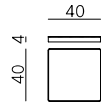

Cushion fabric set / Tessuti set cuscineria

CODE / CODICE	BUSINESS	Q.S / P.C	PRICE
CU113.FOS	fossil	•	€ 57

**CUSRM100 Seat cushion / Cuscino seduta (for / per TO101, TO301)**

Non-removable / Non sfoderabile
Anti-slip / Antiscivolo
With magnet / Con calamita

Washable / Lavabile
Waterproof gel-backing / Fodera impermeabile
Weight / Peso : 0,2 Kg

packaging / imballo  1  0,01  0,4 CM L 42 P 40 H 3

Cushion fabric set / Tessuti set cuscineria

CODE / CODICE	BUSINESS	Q.S / P.C	PRICE
CUSRM100.FOS	fossil	•	€ 45
CUSRM100.ECS	ecru		€ 45
CUSRM100.TPS	taupe		€ 45
CUSRM100.BRS	brisa		€ 45
CUSRM100.GRS	grey		€ 45
CUSRM100.ANS	anthracite		€ 45

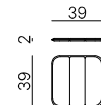
**TO3180 Table / Tavolo 180x90**

Galvanized steel / Acciaio zincato
Knockdown / Smontabile

Weight / Peso : 36 Kg

packaging / imballo  1  0,24  42 CM L 189 P 95 H 14

Frame / Struttura

CODE / CODICE	FRAME / STRUTTURA	Q.S / P.C	PRICE / €
TO3180.AG	ancient grey / grigio antico	•	€ 711
TO3180.BRO	bronze / bronzo		€ 711
TO3180.BS	ivory white / bianco perla		€ 711

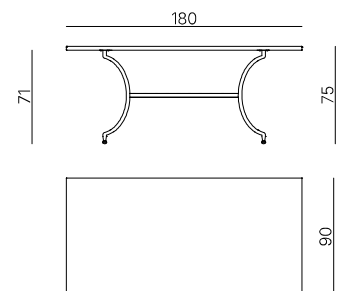



Tosca

T01450 Table / Tavolo Ø 145

Galvanized steel / Acciaio zincato

Knockdown / Smontabile

Weight / Peso : 38,5 Kg

packaging / imballo  1  0,24  70 CM L 147 P 147 H 11

Frame / Struttura

CODE / CODICE	FRAME / STRUTTURA	Q.S / P.C	PRICE / €
T01450.AG	ancient grey / grigio antico	•	€ 1.063
T01450.BRO	bronze / bronzo		€ 1.063
T01450.BS	ivory white / bianco perla		€ 1.063

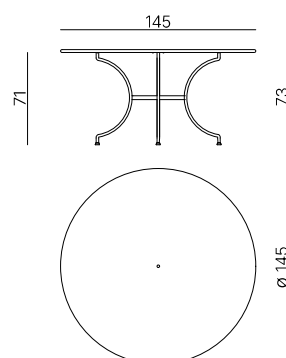



Twist

Designed by Vermobil Team



frame / struttura

standard colours / colori standard

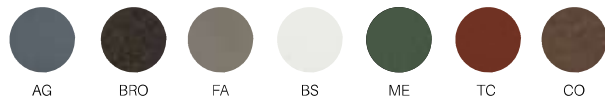

AG BRO FA BS ME TC CO

special colours / colori speciali

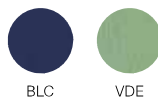

BLC VDE

fabrics / tessuti

business

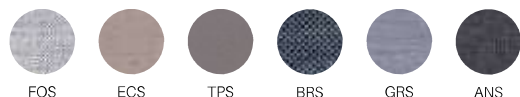

FOS ECS TPS BRS GRS ANS



Pillow Pag. 174

More information on colors and fabrics from page 194 / Più informazioni su colori e tessuti da pagina 194

TW100 Chair / Sedia

Galvanized steel / Acciaio zincato
Stackable / Impilabile (8 pcs)

CATAS
Weight / Peso : 5 Kg

packaging / imballo  4  0,33  22 CM L 102 P 65 H 50

Frame / Struttura

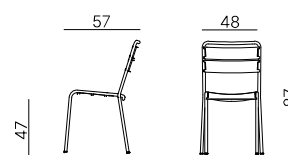

CODE / CODICE	FRAME / STRUTTURA	Q.S / P.C	PRICE / €
TW100.AG	ancient grey / grigio antico	•	€ 105
TW100.BRO	bronze / bronzo		€ 105
TW100.FA	mud grey / fango	•	€ 105
TW100.BS	ivory white / bianco perla	•	€ 105
TW100.ME	mint green / menta		€ 105
TW100.TC	terracotta / terracotta		€ 105
TW100.CO	corten / corten		€ 105
TW100.BLC	cobalt blue / blu cobalto		€ 105
TW100.VDE	sage green / verde salvia		€ 105



TW300 Armchair / Poltrona

Galvanized steel / Acciaio zincato
Stackable / Impilabile (8 pcs)

CATAS
Weight / Peso : 6 Kg

packaging / imballo  4  0,39  25 CM L 102 P 65 H 59

Frame / Struttura

CODE / CODICE	FRAME / STRUTTURA	Q.S / P.C	PRICE / €
TW300.AG	ancient grey / grigio antico	•	€ 131
TW300.BRO	bronze / bronzo		€ 131
TW300.FA	mud grey / fango	•	€ 131
TW300.BS	ivory white / bianco perla	•	€ 131
TW300.ME	mint green / menta		€ 131
TW300.TC	terracotta / terracotta		€ 131
TW300.CO	corten / corten		€ 131
TW300.BLC	cobalt blue / blu cobalto		€ 131
TW300.VDE	sage green / verde salvia		€ 131

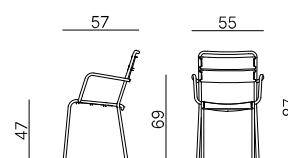



Twist

TW150 Barstool / Sgabello

Galvanized steel / Acciaio zincato

Stackable / Impilabile (4 pcs)

Weight / Peso : 6 Kg

packaging / imballo  1  0,28  9 CM L 97 P 60 H 48

Frame / Struttura

CODE / CODICE	FRAME / STRUTTURA	Q.S / P.C	PRICE / €
TW150.AG	ancient grey / grigio antico	•	€ 189
TW150.BRO	bronze / bronzo		€ 189
TW150.FA	mud grey / fango	•	€ 189
TW150.BS	ivory white / bianco perla	•	€ 189
TW150.ME	mint green / menta		€ 189
TW150.TC	terracotta / terracotta		€ 189
TW150.CO	corten / corten		€ 189
TW150.BLC	cobalt blue / blu cobalto		€ 189
TW150.VDE	sage green / verde salvia		€ 189

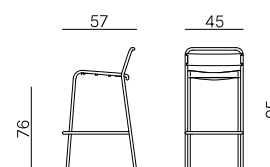

CUSRM100 Seat cushion / Cuscino seduta (for / per TW100, TW300, TW150)

Non-removable / Non sfoderabile



Anti-slip / Antiscivolo

With magnet / Con calamita

Washable / Lavabile

Waterproof gel-backing / Fodera impermeabile

Weight / Peso : 0,2 Kg

packaging / imballo  1  0,01  0,4 CM L 42 P 40 H 3

Cushion fabric set / Tessuti set cuscineria

CODE / CODICE	BUSINESS	Q.S / P.C	PRICE
CUSRM100.FOS	fossil	•	€ 45
CUSRM100.ECS	ecru		€ 45
CUSRM100.TPS	taupe		€ 45
CUSRM100.BRS	brisa		€ 45
CUSRM100.GRS	grey		€ 45
CUSRM100.ANS	anthracite		€ 45

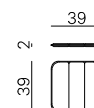



TW600 Lounge chair / Poltrona bassa

Galvanized steel / Acciaio zincato

Stackable / Impilabile (4 pcs)

Weight / Peso : 7,5 Kg

packaging / imballo  1  0,41  11 CM L 73 P 74 H 76

Frame / Struttura

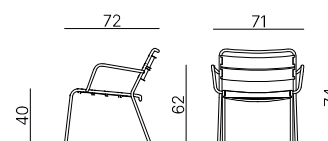

CODE / CODICE	FRAME / STRUTTURA	O.S / P.C	PRICE / €
TW600.AG	ancient grey / grigio antico	•	€ 269
TW600.BRO	bronze / bronzo		€ 269
TW600.FA	mud grey / fango	•	€ 269
TW600.BS	ivory white / bianco perla	•	€ 269
TW600.ME	mint green / menta		€ 269
TW600.TC	terracotta / terracotta		€ 269
TW600.CO	corten / corten		€ 269
TW600.BLC	cobalt blue / blu cobalto		€ 269
TW600.VDE	sage green / verde salvia		€ 269



TW200 Footrest / Poggiapiedi

Galvanized steel / Acciaio zincato

Weight / Peso : 4 Kg

packaging / imballo  1  0,12  6 CM L 57 P 52 H 42

Frame / Struttura

CODE / CODICE	FRAME / STRUTTURA	O.S / P.C	PRICE / €
TW200.AG	ancient grey / grigio antico	•	€ 164
TW200.BRO	bronze / bronzo		€ 164
TW200.FA	mud grey / fango	•	€ 164
TW200.BS	ivory white / bianco perla	•	€ 164
TW200.ME	mint green / menta		€ 164
TW200.TC	terracotta / terracotta		€ 164
TW200.CO	corten / corten		€ 164
TW200.BLC	cobalt blue / blu cobalto		€ 164
TW200.VDE	sage green / verde salvia		€ 164



Twist

CUSRM600 Seat cushion / Cuscino seduta (for / per TW600)

Non-removable / Non sfoderabile



Anti-slip / Antiscivolo

With magnet / Con calamita

Washable / Lavabile

Waterproof gel-backing / Fodera impermeabile

Weight / Peso : 0,4 Kg

packaging / imballo  1  0,01  0,6 CM L 56 P 48 H 3

Cushion fabric set / Tessuti set cuscineria

CODE / CODICE	BUSINESS	Q.S / P.C	PRICE
CUSRM600.FOS	fossil	•	€ 54
CUSRM600.ECS	ecru		€ 54
CUSRM600.TPS	taupe		€ 54
CUSRM600.BRS	brisa		€ 54
CUSRM600.GRS	grey		€ 54
CUSRM600.ANS	anthracite		€ 54

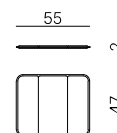

TW2065 Table / Tavolo ø 65

Galvanized steel / Acciaio zincato

Knockdown / Smontabile

Weight / Peso : 8 Kg

packaging / imballo  1  0,06  9 CM L 76 P 11 H 76

Frame / Struttura

CODE / CODICE	FRAME / STRUTTURA	Q.S / P.C	PRICE / €
TW2065.AG	ancient grey / grigio antico	•	€ 203
TW2065.BRO	bronze / bronzo		€ 203
TW2065.FA	mud grey / fango	•	€ 203
TW2065.BS	ivory white / bianco perla	•	€ 203
TW2065.ME	mint green / menta		€ 203
TW2065.TC	terracotta / terracotta		€ 203
TW2065.CO	corten / corten		€ 203
TW2065.BLC	cobalt blue / blu cobalto		€ 203
TW2065.VDE	sage green / verde salvia		€ 203

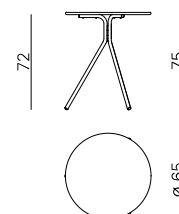



TW2081 Table / Tavolo ø 80

Galvanized steel / Acciaio zincato

Knockdown / Smontabile

Weight / Peso : 10 Kg

packaging / imballo  1  0,08  13 CM L 82 P 10 H 82

Frame / Struttura

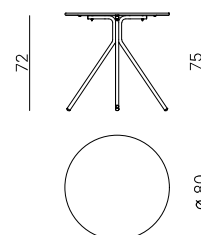

CODE / CODICE	FRAME / STRUTTURA	O.S / P.C	PRICE / €
TW2081.AG	ancient grey / grigio antico	•	€ 260
TW2081.BRO	bronze / bronzo		€ 260
TW2081.FA	mud grey / fango	•	€ 260
TW2081.BS	ivory white / bianco perla	•	€ 260
TW2081.ME	mint green / menta		€ 260
TW2081.TC	terracotta / terracotta		€ 260
TW2081.CO	corten / corten		€ 260
TW2081.BLC	cobalt blue / blu cobalto		€ 260
TW2081.VDE	sage green / verde salvia		€ 260

**TW7071 Table / Tavolo 70x70**

Galvanized steel / Acciaio zincato

Knockdown / Smontabile

Weight / Peso : 11 Kg

packaging / imballo  1  0,05  14 CM L 72 P 10 H 72

Frame / Struttura

CODE / CODICE	FRAME / STRUTTURA	O.S / P.C	PRICE / €
TW7071.AG	ancient grey / grigio antico	•	€ 288
TW7071.BRO	bronze / bronzo		€ 288
TW7071.FA	mud grey / fango	•	€ 288
TW7071.BS	ivory white / bianco perla	•	€ 288
TW7071.ME	mint green / menta		€ 288
TW7071.TC	terracotta / terracotta		€ 288
TW7071.CO	corten / corten		€ 288
TW7071.BLC	cobalt blue / blu cobalto		€ 288
TW7071.VDE	sage green / verde salvia		€ 288

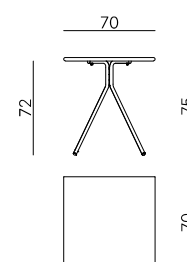



Twist

TW8081 Table / Tavolo 80×80

Galvanized steel / Acciaio zincato

Knockdown / Smontabile

Weight / Peso : 12,5 Kg

packaging / imballo  1  0,07  16 CM L 82 P 10 H 82

Frame / Struttura

CODE / CODICE	FRAME / STRUTTURA	Q.S / P.C	PRICE / €
TW8081.AG	ancient grey / grigio antico	•	€ 302
TW8081.BRO	bronze / bronzo		€ 302
TW8081.FA	mud grey / fango	•	€ 302
TW8081.BS	ivory white / bianco perla	•	€ 302
TW8081.ME	mint green / menta		€ 302
TW8081.TC	terracotta / terracotta		€ 302
TW8081.CO	corten / corten		€ 302
TW8081.BLC	cobalt blue / blu cobalto		€ 302
TW8081.VDE	sage green / verde salvia		€ 302

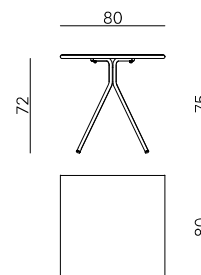



TW900 Table base / Base tavolo

Galvanized steel / Acciaio zincato

Knockdown / Smontabile

Tabletops / Piani tavolo pag. 162



Weight / Peso : 3,5 Kg

packaging / imballo  5  0,17  20 CM L 82 P 27 H 78

Frame / Struttura

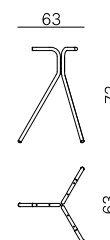
CODE / CODICE	FRAME / STRUTTURA	Q.S / P.C	PRICE / €
TW900.AG	ancient grey / grigio antico	•	€ 91
TW900.BRO	bronze / bronzo		€ 91
TW900.FA	mud grey / fango	•	€ 91
TW900.BS	ivory white / bianco perla	•	€ 91
TW900.ME	mint green / menta		€ 91
TW900.TC	terracotta / terracotta		€ 91
TW900.CO	corten / corten		€ 91
TW900.BLC	cobalt blue / blu cobalto		€ 91
TW900.VDE	sage green / verde salvia		€ 91



TW904 Table base / Base tavoloGalvanized steel / Acciaio zincato
Knockdown / SmontabileTabletops / Piani tavolo pag. 162
Weight / Peso : 4 Kgpackaging / imballo  5  0,17  23 CM L 82 P 27 H 78**Frame / Struttura**

CODE / CODICE	FRAME / STRUTTURA	Q.S / P.C	PRICE / €
TW904.AG	ancient grey / grigio antico	•	€ 107
TW904.BRO	bronze / bronzo		€ 107
TW904.FA	mud grey / fango	•	€ 107
TW904.BS	ivory white / bianco perla	•	€ 107
TW904.ME	mint green / menta		€ 107
TW904.TC	terracotta / terracotta		€ 107
TW904.CO	corten / corten		€ 107
TW904.BLC	cobalt blue / blu cobalto		€ 107
TW904.VDE	sage green / verde salvia		€ 107

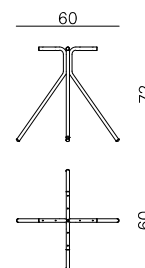

Valentino Summertime

Designed by Vermobil Team



frame / struttura

standard colours / colori standard



fabrics / tessuti

business

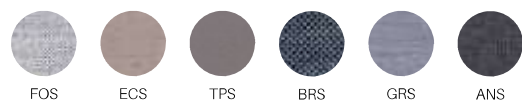

SU100 Chair / Sedia

Galvanized steel / Acciaio zincato

Stackable / Impilabile (8 pcs)

Weight / Peso : 5,5 Kg

packaging / imballo 4 0,36 23,5 CM L 105 P 65 H 53

Frame / Struttura

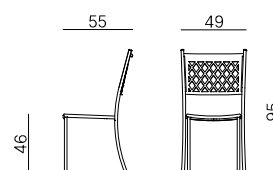

CODE / CODICE	FRAME / STRUTTURA	Q.S / P.C	PRICE / €
SU100.AG	ancient grey / grigio antico	•	€ 165
SU100.BRO	bronze / bronzo	•	€ 165
SU100.BS	ivory white / bianco perla	•	€ 165



SU300 Armchair / Poltrona

Galvanized steel / Acciaio zincato

Stackable / Impilabile (8 pcs)

Weight / Peso : 7 Kgpackaging / imballo  4  0,42  28 CM L 109 P 68 H 57**Frame / Struttura**

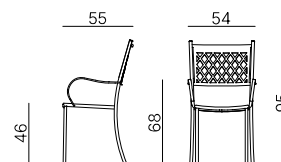

CODE / CODICE	FRAME / STRUTTURA	Q.S / P.C	PRICE / €
SU300.AG	ancient grey / grigio antico	•	€ 193
SU300.BRO	bronze / bronzo	•	€ 193
SU300.BS	ivory white / bianco perla	•	€ 193

**CU113 Seat cushion / Cuscino seduta (for / per SU100, SU300)**

Removable Cushion / Cuscino sfoderabile

Washable / Lavabile

Waterproof gel-backing / Fodera impermeabile

Weight / Peso : 0,4 Kgpackaging / imballo  1  0,01  0,6 CM L 44 P 44 H 6**Cushion fabric set / Tessuti set cuscineria**

CODE / CODICE	BUSINESS	Q.S / P.C	PRICE
CU113.FOS	fossil	•	€ 57

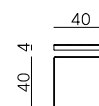
**CUSR100 Seat cushion / Cuscino seduta (for / per SU100, SU300)**



Non-removable / Non sfoderabile

Anti-slip / Antiscivolo

With magnet / Con calamita

Washable / Lavabile

Waterproof gel-backing / Fodera impermeabile

Weight / Peso : 0,2 Kgpackaging / imballo  1  0,01  0,4 CM L 42 P 40 H 3**Cushion fabric set / Tessuti set cuscineria**

CODE / CODICE	BUSINESS	Q.S / P.C	PRICE
CUSR100.FOS	fossil	•	€ 45
CUSR100.ECS	ecru		€ 45
CUSR100.TPS	taupe		€ 45
CUSR100.BRS	brisa		€ 45
CUSR100.GRS	grey		€ 45
CUSR100.ANS	anthracite		€ 45





Valentino Summertime

VA4301 Extendable table / Tavolo allungabile 220/320x100

Galvanized steel / Acciaio zincato
Extension / Prolunga 100cm
Knockdown / Smontabile

Leveling glide / Piedino regolabile
Weight / Peso : 68 Kg

packaging / imballo  1  1,87  93 CM L 233 P 107 H 75

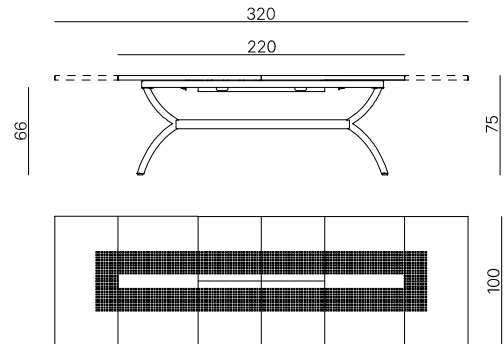

Frame / Struttura

CODE / CODICE	FRAME / STRUTTURA	Q.S / P.C	PRICE / €
VA4301.AG	ancient grey / grigio antico	•	€ 2.148
VA4301.BRO	bronze / bronzo	•	€ 2.148
VA4301.BS	ivory white / bianco perla	•	€ 2.148



SU330 Bench with armrests / Panca con braccioli

Galvanized steel / Acciaio zincato
Stackable / Impilabile (4 pcs)
Weight / Peso : 13 Kg

packaging / imballo  1  0,74  17 CM L 130 P 97 H 59

Frame / Struttura

CODE / CODICE	FRAME / STRUTTURA	Q.S / P.C	PRICE / €
SU330.AG	ancient grey / grigio antico	•	€ 451
SU330.BRO	bronze / bronzo	•	€ 451
SU330.BS	ivory white / bianco perla	•	€ 451

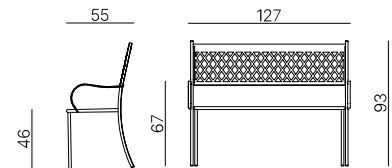

CUSU330 Seat cushion / Cuscino seduta (for / per SU330)

Removable Cushion / Cuscino sfoderabile
Washable / Lavabile

Waterproof gel-backing / Fodera impermeabile
Weight / Peso : 2 Kg

packaging / imballo  1  0,05  3 CM L 151 P 51 H 6

Cushion fabric set / Tessuti set cuscineria

CODE / CODICE	BUSINESS	Q.S / P.C	PRICE
CUSU330.FOS	fossil	•	€ 122

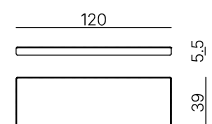



Vegas

Designed by Vermobil Team



frame / struttura

standard colours / colori standard



VE2080 Table / Tavolo 80×80

Galvanized steel / Acciaio zincato

Foldable / Pieghevole

Weight / Peso : 14 Kg

packaging / imballo 1 0,25 16 CM L 81 P 30 H 101

Frame / Struttura

CODE / CODICE	FRAME / STRUTTURA	Q.S / P.C	PRICE / €
VE2080.AG	ancient grey / grigio antico	•	€ 255
VE2080.BRO	bronze / bronzo		€ 255
VE2080.BS	ivory white / bianco perla		€ 255

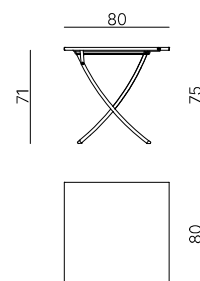

VE2120 Table / Tavolo 120×80

Galvanized steel / Acciaio zincato

Foldable / Pieghevole

Weight / Peso : 19 Kg

packaging / imballo 1 0,34 22 CM L 120 P 28 H 101

Frame / Struttura

CODE / CODICE	FRAME / STRUTTURA	Q.S / P.C	PRICE / €
VE2120.AG	ancient grey / grigio antico	•	€ 360
VE2120.BRO	bronze / bronzo		€ 360
VE2120.BS	ivory white / bianco perla		€ 360

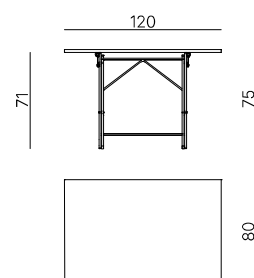



VE2160D Table / Tavolo 160×85

Galvanized steel / Acciaio zincato

Foldable / Pieghevole

Weight / Peso : 25 Kg

packaging / imballo  1  0,57  31 CM L 165 P 33 H 105**Frame / Struttura**

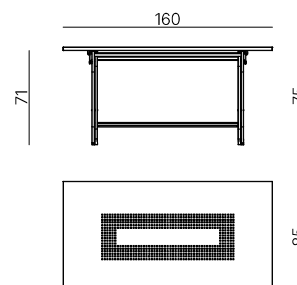

CODE / CODICE	FRAME / STRUTTURA	Q.S / P.C	PRICE / €
VE2160D.AG	ancient grey / grigio antico	•	€ 570
VE2160D.BRO	bronze / bronzo		€ 570
VE2160D.BS	ivory white / bianco perla		€ 570

**VE2185D Table / Tavolo 185×85**

Galvanized steel / Acciaio zincato

Foldable / Pieghevole

Weight / Peso : 28 Kg

packaging / imballo  1  0,65  33 CM L 187 P 33 H 105**Frame / Struttura**

CODE / CODICE	FRAME / STRUTTURA	Q.S / P.C	PRICE / €
VE2185D.AG	ancient grey / grigio antico	•	€ 618
VE2185D.BRO	bronze / bronzo		€ 618
VE2185D.BS	ivory white / bianco perla		€ 618

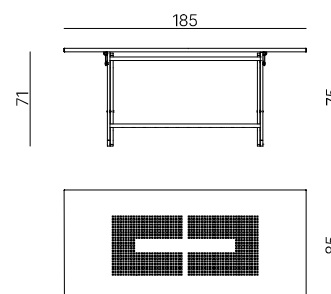

Vera

Designed by Patrick Norguet



frame / struttura

standard colours / colori standard



AG



BS



TC



CO

special colours / colori speciali



BLC



VDE

back and seat batyline / batyline seduta e schienale

basic



STL



CLA



OCR



CRC



ICC

More information on colors and fabrics from page 194 / Più informazioni su colori e tessuti da pagina 194

VR110 Chair / Sedia

Galvanized steel / Acciaio zincato
Batyline fabric / Tessuto Batyline

Stackable / Impilabile (6 pcs)
Weight / Peso : 4,5 Kg

packaging / imballo  4  0,32  23 CM L 98 P 63 H 52

Frame / Struttura

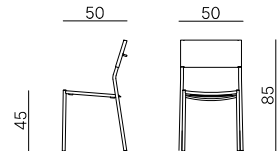

CODE / CODICE	FRAME / STRUTTURA	EDEN	Q.S / P.C	PRICE / €
VR110.AG/STL	ancient grey / grigio antico	steel	•	€ 165
VR110.BS/CLA	ivory white / bianco perla	clay		€ 165
VR110.TC/OCR*	terracotta / terracotta	ocre		€ 165
VR110.CO/STL*	corten / corten	steel		€ 165
VR110.BLC/ICC*	cobalt blue / blu cobalto	ice cube		€ 165
VR110.VDE/CRC*	sage green / verde salvia	crocodile		€ 165
VR110KIT.MC	*items included / articoli inclusi			€ 660



VR310 Armchair / Poltrona

Galvanized steel / Acciaio zincato
Batyline fabric / Tessuto Batyline

Stackable / Impilabile (6 pcs)
Weight / Peso : 6 Kg

packaging / imballo  4  0,39  29 CM L 98 P 68 H 58

Frame / Struttura

CODE / CODICE	FRAME / STRUTTURA	EDEN	Q.S / P.C	PRICE / €
VR310.AG/STL	ancient grey / grigio antico	steel	•	€ 165
VR310.BS/CLA	ivory white / bianco perla	clay		€ 165
VR310.TC/OCR*	terracotta / terracotta	ocre		€ 165
VR310.CO/STL*	corten / corten	steel		€ 165
VR310.BLC/ICC*	cobalt blue / blu cobalto	ice cube		€ 165
VR310.VDE/CRC*	sage green / verde salvia	crocodile		€ 165
VR310KIT.MC	*items included / articoli inclusi			€ 660

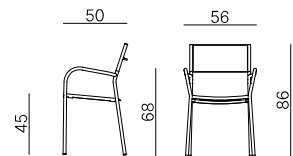

VR150 Barstool / Sgabello

Galvanized steel / Acciaio zincato
Batyline fabric / Tessuto Batyline

Stackable / Impilabile (6 pcs)
Weight / Peso : 6 Kg

packaging / imballo  1  0,29  7 CM L 104 P 54 H 52

Frame / Struttura

CODE / CODICE	FRAME / STRUTTURA	EDEN	Q.S / P.C	PRICE / €
VR150.AG/STL	ancient grey / grigio antico	steel	•	€ 212
VR150.BS/CLA	ivory white / bianco perla	clay		€ 212
VR150.TC/OCR	terracotta / terracotta	ocre		€ 212
VR150.CO/STL	corten / corten	steel		€ 212
VR150.BLC/ICC	cobalt blue / blu cobalto	ice cube		€ 212
VR150.VDE/CRC	sage green / verde salvia	crocodile		€ 212

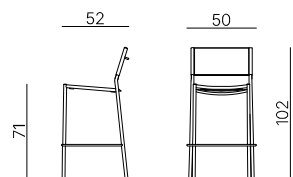

Vera

CUSVR310 Seat cushion / Cuscino seduta (for / per VR110, VR310, VR150)

Batyline fabric / Tessuto Batyline
Non-removable / Non sfoderabile
Anti-slip / Antiscivolo

With magnet / Con calamita
Washable / Lavabile
Weight / Peso : 0,3 Kg

packaging / imballo  1  0,01  0,5 CM L 42 P 43 H 3

Cushion fabric set / Tessuti set cuscineria

CODE / CODICE	EDEN	Q.S / P.C	PRICE
CUSVR310.STL	steel	•	€ 64
CUSVR310.CLA	clay		€ 64
CUSVR310.OCR	ocre		€ 64
CUSVR310.CRC	crocodile		€ 64
CUSVR310.ICC	ice cube		€ 64

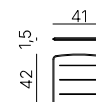

VR610 Lounge chair / Poltrona bassa

Galvanized steel / Acciaio zincato
Batyline fabric / Tessuto Batyline

Stackable / Impilabile (6 pcs)
Weight / Peso : 6 Kg

packaging / imballo  1  0,36  9 CM L 68 P 67 H 79

Frame / Struttura

CODE / CODICE	FRAME / STRUTTURA	EDEN	Q.S / P.C	PRICE / €
VR610.AG/STL	ancient grey / grigio antico	steel		€ 298
VR610.BS/CLA	ivory white / bianco perla	clay		€ 298
VR610.TC/OCR	terracotta / terracotta	ocre		€ 298
VR610.VDE/CRC	sage green / verde salvia	crocodile		€ 298
VR610.CO/STL	corten / corten	steel		€ 298
VR610.BLC/ICC	cobalt blue / blu cobalto	ice cube		€ 298

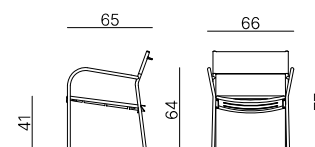

CUSVR610 Seat cushion / Cuscino seduta (for / per VR610)

Batyline fabric / Tessuto Batyline
Non-removable / Non sfoderabile
Anti-slip / Antiscivolo

With magnet / Con calamita
Washable / Lavabile
Weight / Peso : 0,5 Kg

packaging / imballo  1  0,01  0,8 CM L 60 P 53 H 3

Cushion fabric set / Tessuti set cuscineria

CODE / CODICE	BUSINESS	Q.S / P.C	PRICE
CUSVR610.STL	steel		€ 95
CUSVR610.CLA	clay		€ 95
CUSVR610.OCR	ocre		€ 95
CUSVR610.CRC	crocodile		€ 95
CUSVR610.ICC	ice cube		€ 95

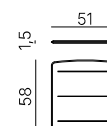

VR200 Footrest / Poggiapiedi

Galvanized steel / Acciaio zincato

Weight / Peso : 3 Kgpackaging / imballo  1  0,09  4 CM L 52 P 52 H 33**Frame / Struttura**

CODE / CODICE	FRAME / STRUTTURA	O.S / P.C	PRICE / €
VR200.AG	ancient grey / grigio antico		€ 203
VR200.BS	ivory white / bianco perla		€ 203
VR200.TC	terracotta / terracotta		€ 203
VR200.VDE	sage green / verde salvia		€ 203
VR200.CO	corten / corten		€ 203
VR200.BLC	cobalt blue / blu cobalto		€ 203

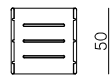
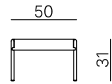

Verdea

Designed by Nicola Bonriposi



frame / struttura

standard colours / colori standard

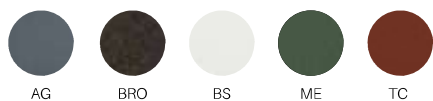

fabrics / tessuti

business

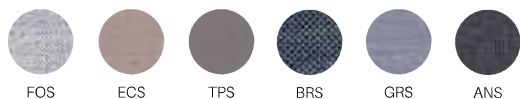

sunset

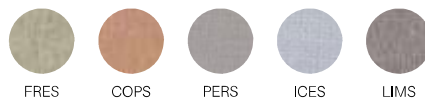

avant-garde



Pillow pag. 174

More information on colors and fabrics from page 194 / Più informazioni su colori e tessuti da pagina 194"

VD100 Chair / Sedia

Aluminium / Alluminio

Stackable / Impilabile (4 pcs)

Weight / Peso : 5 Kg

packaging / imballo  2  0,28  13 CM L 90 P 60 H 51

Frame / Struttura

CODE / CODICE	FRAME / STRUTTURA	Q.S / P.C	PRICE / €
VD100.AG	ancient grey / grigio antico		€ 351
VD100.BRO	bronze / bronzo	•	€ 351
VD100.BS	ivory white / bianco perla		€ 351
VD100.ME	mint green / menta		€ 351
VD100.TC	terracotta / terracotta	•	€ 351

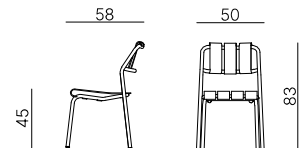



VD300 Armchair / Poltrona

Aluminium / Alluminio

Stackable / Impilabile (4 pcs)

Weight / Peso : 5,6 Kg

packaging / imballo  2  0,34  14,5 CM L 90 P 62 H 61

Frame / Struttura

CODE / CODICE	FRAME / STRUTTURA	Q.S / P.C	PRICE / €
VD300.AG	ancient grey / grigio antico		€ 394
VD300.BRO	bronze / bronzo	•	€ 394
VD300.BS	ivory white / bianco perla		€ 394
VD300.ME	mint green / menta		€ 394
VD300.TC	terracotta / terracotta	•	€ 394

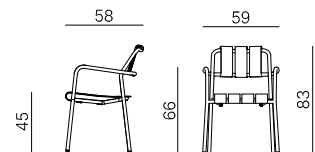

CUSVD100 Seat cushion / Cuscino seduta (for / per VD100, VD300)



Removable Cushion / Cuscino sfoderabile

Anti-slip / Antiscivolo

Washable / Lavabile

Waterproof gel-backing / Fodera impermeabile

Weight / Peso : 0,3 Kg

packaging / imballo  1  0,01  0,5 CM L 49 P 42 H 7

Cushion fabric set / Tessuti set cuscineria

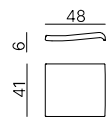

CODE / CODICE	BUSINESS	Q.S / P.C	PRICE	CODE / CODICE	SUNSET	Q.S / P.C	PRICE	CODE / CODICE	AVANT GARDE	Q.S / P.C	PRICE
CUSVD100.FOS	fossil		€ 105	CUSVD100.FRES	fresh		€ 120	CUSVD100.CSS	cream star		€ 120
CUSVD100.ECS	ecru		€ 105	CUSVD100.COPS	copper		€ 120	CUSVD100.FSS	mud grey star		€ 120
CUSVD100.TPS	taupe		€ 105	CUSVD100.PERS	pergamino		€ 120	CUSVD100.WSS	white star		€ 120
CUSVD100.BRS	brisa		€ 105	CUSVD100.ICES	ice		€ 120				
CUSVD100.GRS	grey		€ 105	CUSVD100.LIMS	limestone		€ 120				
CUSVD100.ANS	anthracite		€ 105								



Verdea

VD1300 Table / Tavolo ø 130

Aluminium / Alluminio
Knockdown / Smontabile
Weight / Peso : 27 Kg

packaging / imballo  1  0,23  32 CM L 137 P 137 H 12

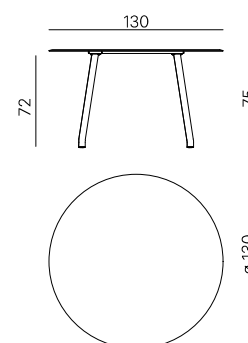

Frame / Struttura

CODE / CODICE	FRAME / STRUTTURA	Q.S / P.C	PRICE / €
VD1300.AG	ancient grey / grigio antico		€ 1.626
VD1300.BRO	bronze / bronzo	•	€ 1.626
VD1300.BS	ivory white / bianco perla		€ 1.626
VD1300.ME	mint green / menta		€ 1.626
VD1300.TC	terracotta / terracotta	•	€ 1.626



VD220100 Table / Tavolo 220x100

Aluminium / Alluminio
Knockdown / Smontabile
Weight / Peso : 45 Kg

packaging / imballo  1  0,31  52 CM L 232 P 112 H 12

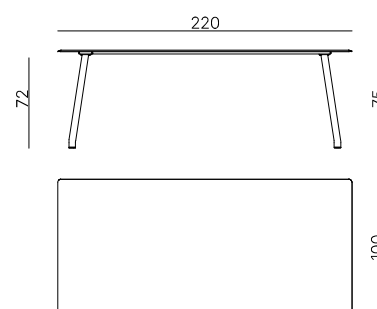

Frame / Struttura

CODE / CODICE	FRAME / STRUTTURA	Q.S / P.C	PRICE / €
VD220100.AG	ancient grey / grigio antico		€ 2.318
VD220100.BRO	bronze / bronzo	•	€ 2.318
VD220100.BS	ivory white / bianco perla		€ 2.318
VD220100.ME	mint green / menta		€ 2.318
VD220100.TC	terracotta / terracotta	•	€ 2.318



VD150 Barstool / Sgabello

Aluminium / Alluminio
Stackable / Impilabile (4 pcs)
Weight / Peso : 4 Kg

packaging / imballo  1  0,21  6,5 CM L 84 P 50 H 49

Frame / Struttura

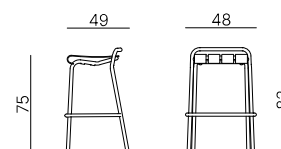

CODE / CODICE	FRAME / STRUTTURA	Q.S / P.C	PRICE / €
VD150.AG	ancient grey / grigio antico		€ 318
VD150.BRO	bronze / bronzo	•	€ 318
VD150.BS	ivory white / bianco perla		€ 318
VD150.ME	mint green / menta		€ 318
VD150.TC	terracotta / terracotta	•	€ 318



CUSVD150 Seat cushion / Cuscino seduta (for / per VD150)

Removable Cushion / Cuscino sfoderabile
Anti-slip / Antiscivolo
Washable / Lavabile

Waterproof gel-backing / Fodera impermeabile
Weight / Peso : 0,3 Kg

packaging / imballo  1  0,01  0,5 CM L 42 P 40 H 7

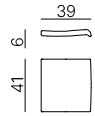



Cushion fabric set / Tessuti set cuscineria

CODE / CODICE	BUSINESS	Q.S / P.C	PRICE	CODE / CODICE	SUNSET	Q.S / P.C	PRICE	CODE / CODICE	AVANT GARDE	Q.S / P.C	PRICE
CUSVD150.FOS	fossil		€ 105	CUSVD150.FRES	fresh		€ 120	CUSVD150.CSS	cream star		€ 120
CUSVD150.ECS	ecru		€ 105	CUSVD150.COPS	copper		€ 120	CUSVD150.FSS	mud grey star		€ 120
CUSVD150.TPS	taupe		€ 105	CUSVD150.PERS	pergamino		€ 120	CUSVD150.WSS	white star		€ 120
CUSVD150.BRS	brisa		€ 105	CUSVD150.ICES	ice		€ 120				
CUSVD150.GRS	grey		€ 105	CUSVD150.LIMS	limestone		€ 120				
CUSVD150.ANS	anthracite		€ 105								

VD600 Lounge chair / Poltrona bassa

Aluminium / Alluminio
Stackable / Impilabile (4 pcs)
Weight / Peso : 8 Kg

packaging / imballo  1  0,41  12 CM L 75 P 71 H 77

Frame / Struttura

CODE / CODICE	FRAME / STRUTTURA	Q.S / P.C	PRICE / €
VD600.AG	ancient grey / grigio antico		€ 504
VD600.BRO	bronze / bronzo	•	€ 504
VD600.BS	ivory white / bianco perla		€ 504
VD600.ME	mint green / menta		€ 504
VD600.TC	terracotta / terracotta	•	€ 504

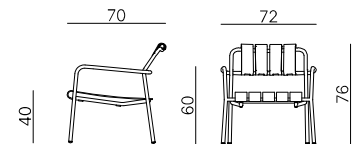

VD630 Sofa / Divano

Aluminium / Alluminio
Stackable / Impilabile (4 pcs)
Weight / Peso : 17,5 Kg

packaging / imballo  1  0,81  23 CM L 149 P 71 H 77

Frame / Struttura

CODE / CODICE	FRAME / STRUTTURA	Q.S / P.C	PRICE / €
VD630.AG	ancient grey / grigio antico		€ 1.227
VD630.BRO	bronze / bronzo	•	€ 1.227
VD630.BS	ivory white / bianco perla		€ 1.227
VD630.ME	mint green / menta		€ 1.227
VD630.TC	terracotta / terracotta	•	€ 1.227

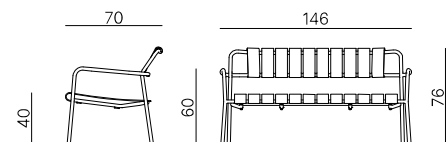

Verdea

CUSVD600 Seat cushion / Cuscino seduta (for / per VD600, VD630)

Removable Cushion / Cuscino sfoderabile
Anti-slip / Antiscivolo
Washable / Lavabile

Waterproof gel-backing / Fodera impermeabile
Weight / Peso : 0,7 Kg

packaging / imballo  1  0,02  1 CM L 64 P 51 H 7

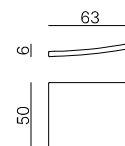

Cushion fabric set / Tessuti set cuscineria

CODE / CODICE	BUSINESS	Q.S / P.C	PRICE	CODE / CODICE	SUNSET	Q.S / P.C	PRICE	CODE / CODICE	AVANT GARDE	Q.S / P.C	PRICE
CUSVD600.FOS	fossil		€ 169	CUSVD600.FRES	fresh		€ 198	CUSVD600.CSS	cream star		€ 198
CUSVD600.ECS	ecru		€ 169	CUSVD600.COPS	copper		€ 198	CUSVD600.FSS	mud grey star		€ 198
CUSVD600.TPS	taupe		€ 169	CUSVD600.PERS	pergamino		€ 198	CUSVD600.WSS	white star		€ 198
CUSVD600.BRS	brisa		€ 169	CUSVD600.ICES	ice		€ 198				
CUSVD600.GRS	grey		€ 169	CUSVD600.LIMS	limestone		€ 198				
CUSVD600.ANS	anthracite		€ 169								



Verdea Rope

Designed by Nicola Bonriposi



frame / struttura

standard colours / colori standard

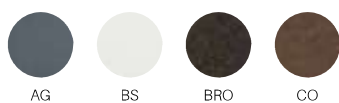

fabrics / tessuti

business

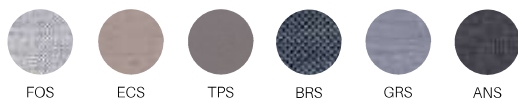

sunset

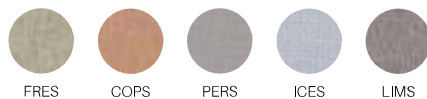

avant-garde

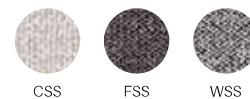

rope / corda



Teak



Pillow pag. 174



More information on colors and fabrics from page 194 / Più informazioni su colori e tessuti da pagina 194

VD10X Chair / Sedia

Aluminium / Alluminio

Weaven rope backrest / Schienale incordato

Stackable / Impilabile (4 pcs)

Weight / Peso : 4,6 Kgpackaging / imballo  2  0,28  12,5 CM L 90 P 60 H 51**Frame / Struttura**

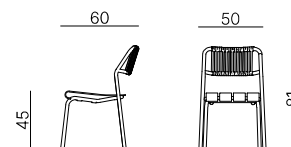

CODE / CODICE	FRAME / STRUTTURA	ROPE / CORDA	Q.S / P.C	PRICE / €
VD105.AG	ancient grey / grigio antico	black / nero		€ 365
VD104.BS	ivory white / bianco perla	mud grey / fango		€ 365
VD109.BRO	bronze / bronzo	taupe / talpa		€ 365
VD109.CO	corten / corten	taupe / talpa		€ 365

**VD30X Armchair / Poltrona**

Aluminium / Alluminio

Weaven rope backrest / Schienale incordato

Stackable / Impilabile (4 pcs)

Weight / Peso : 5,2 Kgpackaging / imballo  2  0,34  13,5 CM L 90 P 62 H 61**Frame / Struttura**

CODE / CODICE	FRAME / STRUTTURA	ROPE / CORDA	Q.S / P.C	PRICE / €
VD305.AG	ancient grey / grigio antico	black / nero		€ 588
VD304.BS	ivory white / bianco perla	mud grey / fango		€ 588
VD309.BRO	bronze / bronzo	taupe / talpa		€ 588
VD309.CO	corten / corten	taupe / talpa		€ 588

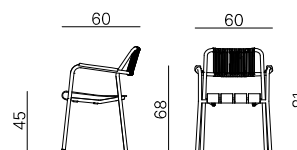

**CUSVD100 Seat cushion / Cuscino seduta (for / per VD10X, VD30X)**

Removable Cushion / Cuscino sfoderabile

Anti-slip / Antiscivolo

Washable / Lavabile

Waterproof gel-backing / Fodera impermeabile

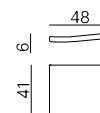

Weight / Peso : 0,3 Kgpackaging / imballo  1  0,01  0,5 CM L 49 P 42 H 7**Cushion fabric set / Tessuti set cuscineria**

CODE / CODICE	BUSINESS	Q.S / P.C	PRICE	CODE / CODICE	SUNSET	Q.S / P.C	PRICE	CODE / CODICE	AVANT GARDE	Q.S / P.C	PRICE
CUSVD100.FOS	fossil		€ 105	CUSVD100.FRES	fresh		€ 120	CUSVD100.CSS	cream star		€ 120
CUSVD100.ECS	ecru		€ 105	CUSVD100.COPS	copper		€ 120	CUSVD100.FSS	mud grey star		€ 120
CUSVD100.TPS	taupe		€ 105	CUSVD100.PERS	pergamino		€ 120	CUSVD100.WSS	white star		€ 120
CUSVD100.BRS	brisa		€ 105	CUSVD100.ICES	ice		€ 120				
CUSVD100.GRS	grey		€ 105	CUSVD100.LIMS	limestone		€ 120				
CUSVD100.ANS	anthracite		€ 105								

Verdea Rope

VD60X Lounge chair / Poltrona bassa

Aluminium / Alluminio Stackable / Impilabile (4 pcs)
Weaven rope backrest / Schienale incordato **Weight / Peso : 8 Kg**

packaging / imballo  1  0,41  12 CM L 75 P 71 H 77

Frame / Struttura

CODE / CODICE	FRAME / STRUTTURA	ROPE / CORDA	Q.S / P.C	PRICE / €
VD605.AG	ancient grey / grigio antico	black / nero		€ 768
VD604.BS	ivory white / bianco perla	mud grey / fango		€ 768
VD609.BRO	bronze / bronzo	taupe / talpa		€ 768
VD609.CO	corten / corten	taupe / talpa		€ 768

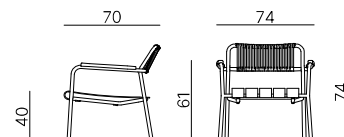

VD63X Sofa / Divano

Aluminium / Alluminio Stackable / Impilabile (4 pcs)
Weaven rope backrest / Schienale incordato **Weight / Peso : 17,5 Kg**

packaging / imballo  1  0,81  23 CM L 149 P 71 H 77

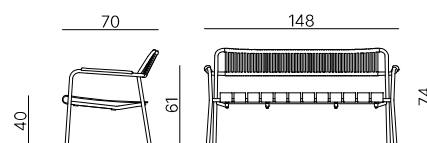

Frame / Struttura

CODE / CODICE	FRAME / STRUTTURA	ROPE / CORDA	Q.S / P.C	PRICE / €
VD635.AG	ancient grey / grigio antico	black / nero		€ 1.409
VD634.BS	ivory white / bianco perla	mud grey / fango		€ 1.409
VD639.BRO	bronze / bronzo	taupe / talpa		€ 1.409
VD639.CO	corten / corten	taupe / talpa		€ 1.409



CUSVD600 Seat cushion / Cuscino seduta (for / per VD60X, VD63X)

Removable Cushion / Cuscino sfoderabile Waterproof gel-backing / Fodera impermeabile
Anti-slip / Antiscivolo **Weight / Peso : 0,7 Kg**
Washable / Lavabile

packaging / imballo  1  0,02  1 CM L 64 P 51 H 7

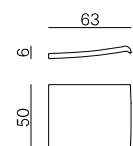

Cushion fabric set / Tessuti set cuscineria

CODE / CODICE	BUSINESS	Q.S / P.C	PRICE	CODE / CODICE	SUNSET	Q.S / P.C	PRICE	CODE / CODICE	AVANT GARDE	Q.S / P.C	PRICE
CUSVD600.FOS	fossil		€ 169	CUSVD600.FRES	fresh		€ 198	CUSVD600.CSS	cream star		€ 198
CUSVD600.ECS	ecru		€ 169	CUSVD600.COPS	copper		€ 198	CUSVD600.FSS	mud grey star		€ 198
CUSVD600.TPS	taupe		€ 169	CUSVD600.PERS	pergamino		€ 198	CUSVD600.WSS	white star		€ 198
CUSVD600.BRS	brisa		€ 169	CUSVD600.ICES	ice		€ 198				
CUSVD600.GRS	grey		€ 169	CUSVD600.LIMS	limestone		€ 198				
CUSVD600.ANS	anthracite		€ 169								



Abri

Designed by Vermobil Team



frame / struttura

standard colours / colori standard



AG

BCO

fabrics / tessuti

business



ECR
151/15

GRE
94/15

ANT
97

More information on colors and fabrics from page 194 / Più informazioni su colori e tessuti da pagina 194

ABW30 Central pole sunshade / Ombrellone a palo centrale Ø300

Pole in laminated tulipwood, Ø60 mm, thickness 1.5 mm
 Slats with quick-release system in tulipwood, 36x18 mm
 Top crown and finial in alder wood
 Pulley opening system equipped with braided rope, 100% polyester

Palo in essenza di toulipier lamellare Ø60 sp. 1,5 mm
 Stecche a sgancio rapido in essenza di toulipier 36x18 mm
 Corona e puntale in essenza di ontano
 Apertura a carrucola dotato di fune in treccia 100% poliestere

packaging / imballo  1  0,13  18 CM L 270 P 22 H 22

Frame / Struttura

CODE / CODICE	FRAME / STRUTTURA	FABRIC / TESSUTO	Q.S / P.C	PRICE / €
ABW30.ECR	wood / legno	151/15		€ 1.418
ABW30.GRE	wood / legno	94/15		€ 1.418

ABPC2525 Central pole sunshade / Ombrellone a palo centrale 250×250

Pole in laminated tulipwood, Ø60 mm, thickness 1.5 mm
 Quick-release slats in tulipwood, 36x18 mm
 Crown and finial in alder wood
 Pulley-operated opening system with braided rope, 100% polyester

Palo in essenza di toulipier lamellare Ø60 sp. 1,5 mm
 Stecche a sgancio rapido in essenza di toulipier 36x18 mm
 Corona e puntale in essenza di ontano
 Apertura a carrucola dotato di fune in treccia 100% poliestere

packaging / imballo  1  0,13  15 CM L 270 P 22 H 22

Frame / Struttura

CODE / CODICE	FRAME / STRUTTURA	FABRIC / TESSUTO	Q.S / P.C	PRICE / €
ABPC2525.AG/ECR	ancient grey / grigio antico	151/15		€ 614
ABPC2525.AG/GRE	ancient grey / grigio antico	94/15		€ 614
ABPC2525.AG/ANT	ancient grey / grigio antico	97		€ 614
ABPC2525.BCO/ECR	semi-opaque white / bianco semiopaco	151/15		€ 614
ABPC2525.BCO/GRE	semi-opaque white / bianco semiopaco	94/15		€ 614

ABPC3030 Telescopic central pole sunshade / Ombrellone a palo centrale 300×300

Pole in aluminum tubing Ø60 mm, thickness 1.5 mm
 Quick-release ribs decorated with grooves, made of aluminum tubing 40x15 mm, thickness 1.5 mm
 PE plastic caps, collar, crown, and finial in nylon
 Pulley-operated opening system with braided rope, 100% polyester

Palo in tubolare di alluminio Ø60 sp.1,5 mm
 Stecche a sgancio rapido decorate con scanalature in tubolare di alluminio 40x15 sp.1,5 mm
 Tappi in plastica PE, collare, corona e puntale in nylon
 Apertura a carrucola dotato di fune in treccia 100% poliestere

packaging / imballo  1  0,15  19,2 CM L 320 P 22 H 22

Frame / Struttura

CODE / CODICE	FRAME / STRUTTURA	FABRIC / TESSUTO	Q.S / P.C	PRICE / €
ABPC3030.AG/ECR	ancient grey / grigio antico	151/15		€ 1.512
ABPC3030.AG/GRE	ancient grey / grigio antico	94/15		€ 1.512
ABPC3030.AG/ANT	ancient grey / grigio antico	97		€ 1.512
ABPC3030.BCO/ECR	semi-opaque white / bianco semiopaco	151/15		€ 1.512
ABPC3030.BCO/GRE	semi-opaque white / bianco semiopaco	94/15		€ 1.512

ABPC3040 Telescopic central pole sunshade / Ombrellone a palo centrale telescopico 300×400

Pole in aluminum tubing Ø60 mm, thickness 1.5 mm
 Quick-release ribs decorated with grooves, made of aluminum tubing 40×15 mm, thickness 1.5 mm
 PE plastic caps, collar, crown, and finial in nylon
 Pulley-operated opening system with braided rope, 100% polyester

Palo in tubolare di alluminio Ø60 sp.1,5 mm
 Stecche a sgancio rapido decorate con scanalature in tubolare di alluminio 40x15 sp.1,5 mm
 Tappi in plastica PE, collare, corona e puntale in nylon
 Apertura a carrucola dotato di fune in treccia 100% poliestere

packaging / imballo  1  0,16  21,4 CM L 330 P 22 H 22

Frame / Struttura

CODE / CODICE	FRAME / STRUTTURA	FABRIC / TESSUTO	Q.S / P.C	PRICE / €
ABPC3040.AG/ECR	ancient grey / grigio antico	151/15		€ 1.664
ABPC3040.AG/GRE	ancient grey / grigio antico	94/15		€ 1.664
ABPC3040.AG/ANT	ancient grey / grigio antico	97		€ 1.664
ABPC3040.BCO/ECR	semi-opaque white / bianco semiopaco	151/15		€ 1.664
ABPC3040.BCO/GRE	semi-opaque white / bianco semiopaco	94/15		€ 1.664

ABPLR3030 Retractable cantilever sunshade / Ombrellone a braccio retrattile 300×300

Post and retractable arm decorated with grooves, made of 92x92 mm H-shaped aluminum tubing with 2 mm thickness.
 Quick-release slats decorated with grooves, made of 30x15 mm aluminum tubing with 1.5 mm thickness.
 Caps in PE plastic, various components in steel, collar and crown in ABS plastic, and tip in nylon.
 Opening system with crank winch and pulleys, equipped with braided steel rope for nautical use.

Palo e braccio retrattile decorato con scanalature in tubolare di alluminio 92x92 sp.2 mm sagomato ad H
 Stecche a sgancio rapido decorate con scanalature in tubolare di alluminio 30x15 sp.1,5 mm
 Tappi in plastica PE, particolari vari in acciaio, collare e corona in plastica ABS e puntale in nylon
 Apertura con arganello a manovella e carrucole dotato di fune in treccia d'acciaio per uso nautico

packaging / imballo  1  0,25  28 CM L 280 P 48 H 18

Frame / Struttura

CODE / CODICE	FRAME / STRUTTURA	FABRIC / TESSUTO	Q.S / P.C	PRICE / €
ABPLR3030.AG/ECR	ancient grey / grigio antico	151/15		€ 3.505
ABPLR3030.AG/GRE	ancient grey / grigio antico	94/15		€ 3.505
ABPLR3030.AG/ANT	ancient grey / grigio antico	97		€ 3.505
ABPLR3030.BCO/ECR	semi-opaque white / bianco semiopaco	151/15		€ 3.505
ABPLR3030.BCO/GRE	semi-opaque white / bianco semiopaco	94/15		€ 3.505

ABPLR3040 Retractable cantilever sunshade / Ombrellone a braccio retrattile 300×400

Post and retractable arm decorated with grooves, made of 92x92 mm H-shaped aluminum tubing with 2 mm thickness.

Quick-release slats decorated with grooves, made of 30x15 mm aluminum tubing with 1.5 mm thickness.

Caps in PE plastic, various components in steel, collar and crown in ABS plastic, and tip in nylon.

Opening system with crank winch and pulleys, equipped with braided steel rope for nautical use.

Palo e braccio retrattile decorato con scanalature in tubolare di alluminio 92x92 sp.2 mm sagomato ad H

Stecche a sgancio rapido decorate con scanalature in tubolare di alluminio 30x15 sp.1,5 mm

Tappi in plastica PE, particolari vari in acciaio, collare e corona in plastica ABS e puntale in nylon

Apertura con arganello a manovella e carrucole dotato di fune in treccia d'acciaio per uso nautico

packaging / imballo  1  0,25  30 CM L 280 P 48 H 18

Frame / Struttura

CODE / CODICE	FRAME / STRUTTURA	FABRIC / TESSUTO	Q.S / P.C	PRICE / €
ABPLR3040.AG/ECR	ancient grey / grigio antico	151/15		€ 3.954
ABPLR3040.AG/GRE	ancient grey / grigio antico	94/15		€ 3.954
ABPLR3040.AG/ANT	ancient grey / grigio antico	97		€ 3.954
ABPLR3040.BCO/ECR	semi-opaque white / bianco semiopaco	151/15		€ 3.954
ABPLR3040.BCO/GRE	semi-opaque white / bianco semiopaco	94/15		€ 3.954

PAL40 Sunshade pole / Palo per ombrellone Ø40

Frame / Struttura

CODE / CODICE	FRAME / STRUTTURA	Q.S / P.C	PRICE / €
YPAL40	galvanized / zincato		€ 0
PAL40.AG	ancient grey / grigio antico		€ 15
PAL40.BCO	semi-opaque white / bianco semiopaco		€ 15

PAL60 Sunshade pole / Palo per ombrellone Ø60

Frame / Struttura

CODE / CODICE	FRAME / STRUTTURA	Q.S / P.C	PRICE / €
YPAL60	galvanized / zincato		€ 0
PAL60.AG	ancient grey / grigio antico		€ 15
PAL60.BCO	semi-opaque white / bianco semiopaco		€ 15

Abri

ABBQ65 Concrete base covered with stone chippings / Base in cemento rivestito in graniglia 65 kg

Dimensions 50x50 cm, thickness 12 cm / Dimensioni 50x50 cm, sp.12cm

Pole included / Palo incluso

Galvanized steel handles / Maniglie in acciaio zincato

packaging / imballo  1  0,26  85 CM L 120 P 80 H 27

Frame / Struttura



CODE / CODICE	FRAME / STRUTTURA	Q.S / P.C	PRICE / €
ABBQ65	concrete / cemento		€ 137

ABCBQ65 Cover for sunshade base / Carter per base ombrellone

Dimensions 51x51 cm, thickness 11,5 cm / Dimensioni 51x51 cm, sp.11,5 cm

Galvanized steel / Acciaio zincato

Weight / Peso : 7 Kg

packaging / imballo  1  0,04  8 CM L 54 P 54 H 13

Frame / Struttura

CODE / CODICE	FRAME / STRUTTURA	Q.S / P.C	PRICE / €
ABCBQ65.AG	ancient grey / grigio antico		€ 107
ABCBQ65.BCO	semi-opaque white / bianco semiopaco		€ 107

ABBPLR Ballast base for side pole sunshade / Base portazavorre per ombrellone a palo laterale

Galvanized steel / Acciaio zincato

Weight / Peso : 19 Kg

packaging / imballo  1  0,06  21 CM L 115 P 80 H 6

Frame / Struttura

CODE / CODICE	FRAME / STRUTTURA	Q.S / P.C	PRICE / €
ABBPLR.AG	ancient grey / grigio antico		€ 330
ABBPLR.BCO	semi-opaque white / bianco semiopaco		€ 330

ABZPL3030 200 kg ballast / Zavorra da 200 kg

14 concrete tiles covered in grit, dimensions 50x50x4

14 mattonelle di cemento rivestito in graniglia dim. 50x50x4

packaging / imballo  1  0,42  220 CM L 120 P 80 H 43

Frame / Struttura

CODE / CODICE	FRAME / STRUTTURA	Q.S / P.C	PRICE / €
ABZPL3030	concrete / cemento		€ 161

ABZPL3040 400 kg ballast / Zavorra da 400 kg

20 concrete tiles covered in grit, dimensions 50x50x4

20 mattonelle di cemento rivestito in graniglia dim. 50x50x4

packaging / imballo  1  0,6  420 CM L 120 P 80 H 60

Frame / Struttura

CODE / CODICE	FRAME / STRUTTURA	Q.S / P.C	PRICE / €
ABZPL3040	concrete / cemento		€ 230

Tabletops / Piani tavolo

Designed by Vermobil Team

frame / struttura

standard colours / colori standard



special colours / colori speciali



verstone[®]
ENAMELED FINISHES

Enameled finishes / **Finiture smaltate**



More information on colors and fabrics on page 194 / Più informazioni su colori e tessuti da pagina 194

PIA6060E Tabletop / Piano tavolo 60×60

Enameled steel / Acciaio smaltato
Straight edge / Bordo dritto
Thickness / Spessore 18mm

Universal assembly system / Sistema universale di montaggio
Weight / Peso : 7 Kg

verstone[®]
ENAMELED FINISHES

packaging / imballo  1  0,06  8 CM L 63 P 4 H 63

Frame / Struttura

CODE / CODICE	FRAME / STRUTTURA	Q.S / P.C	PRICE / €
PIA6060E.EBS	enameled ivory white / bianco perla smaltato		€ 214
PIA6060E.ENE	enameled black / nero smaltato		€ 214
PIA6060E.ETC	enameled terracotta / terracotta smaltato		€ 214

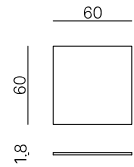
**PIA7070E Tabletop / Piano tavolo 70×70**

Enameled steel / Acciaio smaltato
Straight edge / Bordo dritto
Thickness / Spessore 18mm

Universal assembly system / Sistema universale di montaggio
Weight / Peso : 9 Kg

verstone[®]
ENAMELED FINISHES

packaging / imballo  1  0,08  10 CM L 73 P 4 H 73

Frame / Struttura

CODE / CODICE	FRAME / STRUTTURA	Q.S / P.C	PRICE / €
PIA7070E.EBS	enameled ivory white / bianco perla smaltato		€ 219
PIA7070E.ENE	enameled black / nero smaltato		€ 219
PIA7070E.ETC	enameled terracotta / terracotta smaltato		€ 219

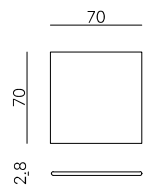
**PIA8080E Tabletop / Piano tavolo 80×80**

Enameled steel / Acciaio smaltato
Straight edge / Bordo dritto
Thickness / Spessore 18mm

Universal assembly system / Sistema universale di montaggio
Weight / Peso : 11 Kg

verstone[®]
ENAMELED FINISHES

packaging / imballo  1  0,10  12 CM L 83 P 4 H 83

Frame / Struttura

CODE / CODICE	FRAME / STRUTTURA	Q.S / P.C	PRICE / €
PIA8080E.EBS	enameled ivory white / bianco perla smaltato		€ 256
PIA8080E.ENE	enameled black / nero smaltato		€ 256
PIA8080E.ETC	enameled terracotta / terracotta smaltato		€ 256

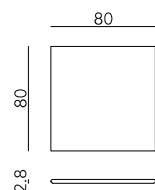

Tabletops

PIA65T Tabletop / Piano tavolo Ø65

Galvanized steel / Acciaio zincato
Round edge / Bordo tondo
Thickness / Spessore 18mm

Universal assembly system / Sistema universale di montaggio
Weight / Peso : 5 Kg

packaging / imballo  1  0,02  6 CM L 68 P 4 H 68

Frame / Struttura

CODE / CODICE	FRAME / STRUTTURA	Q.S / P.C	PRICE / €
PIA65T.AG	ancient grey / grigio antico	•	€ 148
PIA65T.BRO	bronze / bronzo		€ 148
PIA65T.FA	mud grey / fango		€ 148
PIA65T.BS	ivory white / bianco perla		€ 148
PIA65T.ME	mint green / menta		€ 148
PIA65T.TC	terracotta / terracotta		€ 148
PIA65T.CO	corten / corten		€ 148
PIA65T.BLC	cobalt blue / blu cobalto		€ 148
PIA65T.VDE	sage green / verde salvia		€ 148

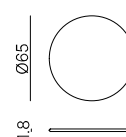

PIA80T Tabletop / Piano tavolo Ø80

Galvanized steel / Acciaio zincato
Round edge / Bordo tondo
Thickness / Spessore 18mm

Universal assembly system / Sistema universale di montaggio
Weight / Peso : 7 Kg

packaging / imballo  1  0,03  8 CM L 83 P 4 H 83

Frame / Struttura

CODE / CODICE	FRAME / STRUTTURA	Q.S / P.C	PRICE / €
PIA80T.AG	ancient grey / grigio antico	•	€ 211
PIA80T.BRO	bronze / bronzo		€ 211
PIA80T.FA	mud grey / fango		€ 211
PIA80T.BS	ivory white / bianco perla		€ 211
PIA80T.ME	mint green / menta		€ 211
PIA80T.TC	terracotta / terracotta		€ 211
PIA80T.CO	corten / corten		€ 211
PIA80T.BLC	cobalt blue / blu cobalto		€ 211
PIA80T.VDE	sage green / verde salvia		€ 211

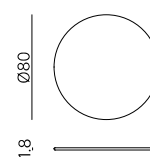

PIA90T Tabletop / Piano tavolo Ø90

Galvanized steel / Acciaio zincato
Round edge / Bordo tondo
Thickness / Spessore 18mm

Universal assembly system / Sistema universale di montaggio
Weight / Peso : 9,5 Kg

packaging / imballo  1  0,04  12 CM L 93 P 4 H 93

Frame / Struttura

CODE / CODICE	FRAME / STRUTTURA	Q.S / P.C	PRICE / €
PIA90T.AG	ancient grey / grigio antico		€ 251
PIA90T.BRO	bronze / bronzo		€ 251
PIA90T.FA	mud grey / fango		€ 251
PIA90T.BS	ivory white / bianco perla		€ 251
PIA90T.ME	mint green / menta		€ 251
PIA90T.TC	terracotta / terracotta		€ 251
PIA90T.CO	corten / corten		€ 251
PIA90T.BLC	cobalt blue / blu cobalto		€ 251
PIA90T.VDE	sage green / verde salvia		€ 251

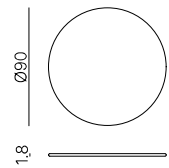

PIA110T Tabletop / Piano tavolo Ø110

Galvanized steel / Acciaio zincato
Round edge / Bordo tondo
Thickness / Spessore 18mm

Universal assembly system / Sistema universale di montaggio
Weight / Peso : 13 Kg

packaging / imballo  1  0,05  16 CM L 113 P 4 H 113

Frame / Struttura

CODE / CODICE	FRAME / STRUTTURA	Q.S / P.C	PRICE / €
PIA110T.AG	ancient grey / grigio antico		€ 270
PIA110T.BRO	bronze / bronzo		€ 270
PIA110T.FA	mud grey / fango		€ 270
PIA110T.BS	ivory white / bianco perla		€ 270
PIA110T.ME	mint green / menta		€ 270
PIA110T.TC	terracotta / terracotta		€ 270
PIA110T.CO	corten / corten		€ 270
PIA110T.BLC	cobalt blue / blu cobalto		€ 270
PIA110T.VDE	sage green / verde salvia		€ 270

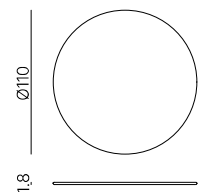

Tabletops

PIA130T Tabletop / Piano tavolo Ø130

Galvanized steel / Acciaio zincato
Round edge / Bordo tondo
Thickness / Spessore 18mm

Universal assembly system / Sistema universale di montaggio
Weight / Peso : 15 Kg

packaging / imballo  1  0,07  19 CM L 133 P 4 H 133

Frame / Struttura

CODE / CODICE	FRAME / STRUTTURA	Q.S / P.C	PRICE / €
PIA130T.AG	ancient grey / grigio antico		€ 294
PIA130T.BRO	bronze / bronzo		€ 294
PIA130T.FA	mud grey / fango		€ 294
PIA130T.BS	ivory white / bianco perla		€ 294
PIA130T.ME	mint green / menta		€ 294
PIA130T.TC	terracotta / terracotta		€ 294
PIA130T.CO	corten / corten		€ 294
PIA130T.BLC	cobalt blue / blu cobalto		€ 294
PIA130T.VDE	sage green / verde salvia		€ 294

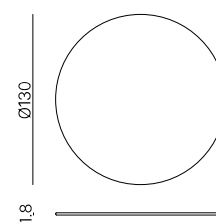

PIA145T Tabletop / Piano tavolo Ø145

Galvanized steel / Acciaio zincato
Round edge / Bordo tondo
Thickness / Spessore 18mm

Universal assembly system / Sistema universale di montaggio
Weight / Peso : 20 Kg

packaging / imballo  1  0,09  24 CM L 148 P 4 H 148

Frame / Struttura

CODE / CODICE	FRAME / STRUTTURA	Q.S / P.C	PRICE / €
PIA145T.AG	ancient grey / grigio antico		€ 384
PIA145T.BRO	bronze / bronzo		€ 384
PIA145T.FA	mud grey / fango		€ 384
PIA145T.BS	ivory white / bianco perla		€ 384
PIA145T.ME	mint green / menta		€ 384
PIA145T.TC	terracotta / terracotta		€ 384
PIA145T.CO	corten / corten		€ 384
PIA145T.BLC	cobalt blue / blu cobalto		€ 384
PIA145T.VDE	sage green / verde salvia		€ 384

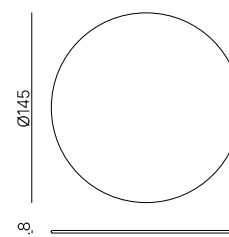

PIA7070T Tabletop / Piano tavolo 70×70

Galvanized steel / Acciaio zincato
Round edge / Bordo tondo
Thickness / Spessore 28mm

Universal assembly system / Sistema universale di montaggio
Weight / Peso : 8 Kg

packaging / imballo  1  0,02  10 CM L 73 P 4 H 73

Frame / Struttura

CODE / CODICE	FRAME / STRUTTURA	Q.S / P.C	PRICE / €
PIA7070T.AG	ancient grey / grigio antico		€ 192
PIA7070T.BRO	bronze / bronzo		€ 192
PIA7070T.FA	mud grey / fango		€ 192
PIA7070T.BS	ivory white / bianco perla		€ 192
PIA7070T.ME	mint green / menta		€ 192
PIA7070T.TC	terracotta / terracotta		€ 192
PIA7070T.CO	corten / corten		€ 192
PIA7070T.BLC	cobalt blue / blu cobalto		€ 192
PIA7070T.VDE	sage green / verde salvia		€ 192

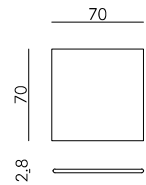
**PIA8080T Tabletop / Piano tavolo 80×80**

Galvanized steel / Acciaio zincato
Round edge / Bordo tondo
Thickness / Spessore 28mm

Universal assembly system / Sistema universale di montaggio
Weight / Peso : 9 Kg

packaging / imballo  1  0,03  10 CM L 83 P 4 H 83

Frame / Struttura

CODE / CODICE	FRAME / STRUTTURA	Q.S / P.C	PRICE / €
PIA8080T.AG	ancient grey / grigio antico		€ 208
PIA8080T.BRO	bronze / bronzo		€ 208
PIA8080T.FA	mud grey / fango		€ 208
PIA8080T.BS	ivory white / bianco perla		€ 208
PIA8080T.ME	mint green / menta		€ 208
PIA8080T.TC	terracotta / terracotta		€ 208
PIA8080T.CO	corten / corten		€ 208
PIA8080T.BLC	cobalt blue / blu cobalto		€ 208
PIA8080T.VDE	sage green / verde salvia		€ 208

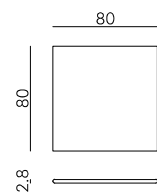

Tabletops

PIA6060D Tabletop / Piano tavolo 60×60

Galvanized steel / Acciaio zincato
Straight edge / Bordo dritto
Thickness / Spessore 18mm

Universal assembly system / Sistema universale di montaggio
Weight / Peso : 5 Kg

packaging / imballo  1  0,02  6 CM L 68 P 4 H 68

Frame / Struttura

CODE / CODICE	FRAME / STRUTTURA	Q.S / P.C	PRICE / €
PIA6060D.AG	ancient grey / grigio antico		€ 152
PIA6060D.BRO	bronze / bronzo		€ 152
PIA6060D.FA	mud grey / fango		€ 152
PIA6060D.BS	ivory white / bianco perla		€ 152
PIA6060D.ME	mint green / menta		€ 152
PIA6060D.TC	terracotta / terracotta		€ 152
PIA6060D.CO	corten / corten		€ 152
PIA6060D.BLC	cobalt blue / blu cobalto		€ 152
PIA6060D.VDE	sage green / verde salvia		€ 152

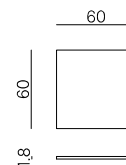

PIA7070D Tabletop / Piano tavolo 70×70

Galvanized steel / Acciaio zincato
Straight edge / Bordo dritto
Thickness / Spessore 18mm

Universal assembly system / Sistema universale di montaggio
Weight / Peso : 7 Kg

packaging / imballo  1  0,02  8 CM L 73 P 4 H 73

Frame / Struttura

CODE / CODICE	FRAME / STRUTTURA	Q.S / P.C	PRICE / €
PIA7070D.AG	ancient grey / grigio antico	•	€ 162
PIA7070D.BRO	bronze / bronzo		€ 162
PIA7070D.FA	mud grey / fango		€ 162
PIA7070D.BS	ivory white / bianco perla		€ 162
PIA7070D.ME	mint green / menta		€ 162
PIA7070D.TC	terracotta / terracotta		€ 162
PIA7070D.CO	corten / corten		€ 162
PIA7070D.BLC	cobalt blue / blu cobalto		€ 162
PIA7070D.VDE	sage green / verde salvia		€ 162

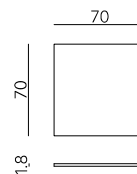

PIA8080D Tabletop / Piano tavolo 80×80

Galvanized steel / Acciaio zincato
Straight edge / Bordo dritto
Thickness / Spessore 18mm

Universal assembly system / Sistema universale di montaggio
Weight / Peso : 9 Kg

packaging / imballo  1  0,03  10 CM L 83 P 4 H 83

Frame / Struttura

CODE / CODICE	FRAME / STRUTTURA	Q.S / P.C	PRICE / €
PIA8080D.AG	ancient grey / grigio antico	•	€ 183
PIA8080D.BRO	bronze / bronzo		€ 183
PIA8080D.FA	mud grey / fango		€ 183
PIA8080D.BS	ivory white / bianco perla		€ 183
PIA8080D.ME	mint green / menta		€ 183
PIA8080D.TC	terracotta / terracotta		€ 183
PIA8080D.CO	corten / corten		€ 183
PIA8080D.BLC	cobalt blue / blu cobalto		€ 183
PIA8080D.VDE	sage green / verde salvia		€ 183

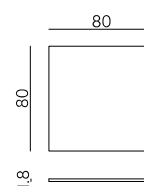
**PIA9090D Tabletop / Piano tavolo 90×90**

Galvanized steel / Acciaio zincato
Straight edge / Bordo dritto
Thickness / Spessore 18mm

Universal assembly system / Sistema universale di montaggio
Weight / Peso : 11 Kg

packaging / imballo  1  0,04  13 CM L 93 P 4 H 93

Frame / Struttura

CODE / CODICE	FRAME / STRUTTURA	Q.S / P.C	PRICE / €
PIA9090D.AG	ancient grey / grigio antico		€ 185
PIA9090D.BRO	bronze / bronzo		€ 185
PIA9090D.FA	mud grey / fango		€ 185
PIA9090D.BS	ivory white / bianco perla		€ 185
PIA9090D.ME	mint green / menta		€ 185
PIA9090D.TC	terracotta / terracotta		€ 185
PIA9090D.CO	corten / corten		€ 185
PIA9090D.BLC	cobalt blue / blu cobalto		€ 185
PIA9090D.VDE	sage green / verde salvia		€ 185

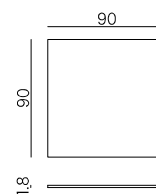

Tabletops

PIA7070A Tabletop / Piano tavolo 70×70

Galvanized steel / Acciaio zincato
Angled edge / Bordo angolato
Thickness / Spessore 28mm

Universal assembly system / Sistema universale di montaggio
Weight / Peso : 6 Kg

packaging / imballo  1  0,02  7 CM L 73 P 4 H 73

Frame / Struttura

CODE / CODICE	FRAME / STRUTTURA	Q.S / P.C	PRICE / €
PIA7070A.AG	ancient grey / grigio antico		€ 185
PIA7070A.BRO	bronze / bronzo		€ 185
PIA7070A.FA	mud grey / fango		€ 185
PIA7070A.BS	ivory white / bianco perla		€ 185
PIA7070A.ME	mint green / menta		€ 185
PIA7070A.TC	terracotta / terracotta		€ 185
PIA7070A.CO	corten / corten		€ 185
PIA7070A.BLC	cobalt blue / blu cobalto		€ 185
PIA7070A.VDE	sage green / verde salvia		€ 185

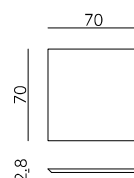

PIA8080A Tabletop / Piano tavolo 80×80

Galvanized steel / Acciaio zincato
Straight edge / Bordo dritto
Thickness / Spessore 18mm

Universal assembly system / Sistema universale di montaggio
Weight / Peso : 9 Kg

packaging / imballo  1  0,03  10 CM L 83 P 4 H 83

Frame / Struttura

CODE / CODICE	FRAME / STRUTTURA	Q.S / P.C	PRICE / €
PIA8080A.AG	ancient grey / grigio antico		€ 190
PIA8080A.BRO	bronze / bronzo		€ 190
PIA8080A.FA	mud grey / fango		€ 190
PIA8080A.BS	ivory white / bianco perla		€ 190
PIA8080A.ME	mint green / menta		€ 190
PIA8080A.TC	terracotta / terracotta		€ 190
PIA8080A.CO	corten / corten		€ 190
PIA8080A.BLC	cobalt blue / blu cobalto		€ 190
PIA8080A.VDE	sage green / verde salvia		€ 190

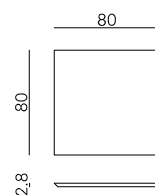



Tabletops and bases / Piani e basi



The Vermobil tabletops, are equipped with an universal fastening system that allows them to be mounted on any type of base. The table below shows the suitable combinations for various Tabletops sizes. I piani Vermobil sono predisposti di un sistema di fissaggio universale che permette il montaggio su qualsiasi tipo di base. La tabella sottostante mostra gli abbinamenti adatti alle varie dimensioni dei piani.

verstone[®]
ENAMELED FINISHES

Enameled finishes / Finiture smaltate *



* Available on items / Disponibili per gli articoli:
PIA6060E, PIA7070E, PIA8080E

metal standard colours / colori standard metallo

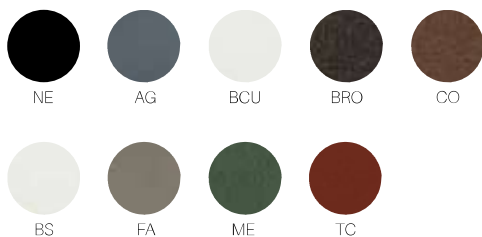

metal special colours / colori speciali metallo



EDGE BORDO	SHAPE FORMA	CODE CODICE	PRICE PREZZO	CH904 € 148
SP 18MM	Ø 65	PIA65T	€ 148	
SP 18MM	Ø 80	PIA80T	€ 211	Ø 80
SP 18MM	Ø 90	PIA90T	€ 251	Ø 90
SP 18MM	Ø 110	PIA110T	€ 270	
SP 18MM	Ø 130	PIA130T	€ 294	
SP 18MM	Ø 145	PIA145T	€ 384	
SP 28MM	70X70	PIA7070T	€ 192	70X70
SP 28MM	80X80	PIA8080T	€ 208	80X80
SP 18MM	60X60	PIA6060D PIA6060E	€ 152 € 214	60X60
SP 18MM	70X70	PIA7070D PIA7070E	€ 162 € 219	70X70
SP 18MM	80X80	PIA8080D PIA8080E	€ 183 € 256	80X80
SP 18MM	90X90	PIA9090D	€ 195	90X90
SP 28MM	70X70	PIA7070A	€ 185	70X70
SP 28MM	80X80	PIA8080A	€ 190	80X80

Tabletops and Bases / Piani e Basi



CH904H
€ 179



BI904
€ 203



BI904H
€ 227



MG904
€ 212



TW904
€ 107



FUDE650
€ 180



FUDE900
€ 293



FUDE1300
€ 316



DE904
€ 245

Ø 65

Ø 65

Ø 65

Ø 65

Ø 80

Ø 80

Ø 80

Ø 80

Ø 80

Ø 80

Ø 80

Ø 90

Ø 90

Ø 90

Ø 110

Ø 110

Ø 130

Ø 130

Ø 145

70X70

70X70

70X70

70X70

70X70

70X70

80X80

80X80

80X80

80X80

60X60

60X60

60X60

60X60

60X60

70X70

70X70

70X70

70X70

70X70

70X70

80X80

80X80

80X80

80X80

90X90

90X90

70X70

70X70

70X70

70X70

70X70

70X70

80X80

80X80

80X80

80X80

Pillow

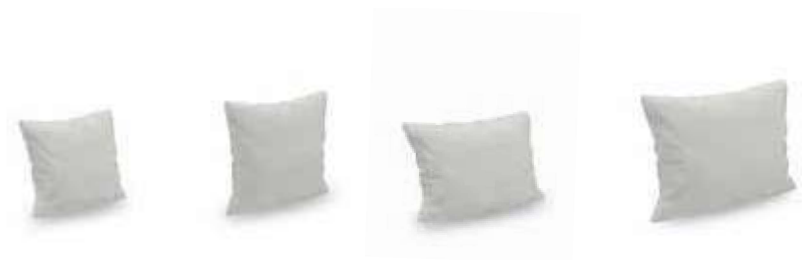

fabrics / tessuti

business



FOS



ECS



TPS



BRS



GRS



ANS

sunset



FRES



COPS



PERS



ICES



LIMS

avant-garde



CSS



FSS





WSS

More information on colors and fabrics from page 194 / Più informazioni su colori e tessuti da pagina 194

CUBDE305 Back cushion / Cuscino schienale 35×35

Removable Cushion / Cuscino sfoderabile
 Washable / Lavabile
 Waterproof gel-backing / Fodera impermeabile
Weight / Peso : 0,3 Kg

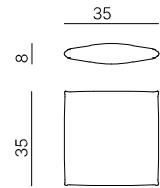

packaging / imballo  1  0,07  0,6 CM L 40 P 40 H 8

**Fabrics / Tessuti**

CODE / CODICE	BUSINESS	Q.S / P.C	PRICE	CODE / CODICE	SUNSET	Q.S / P.C	PRICE	CODE / CODICE	AVANT GARDE	Q.S / P.C	PRICE
CUBDE305.FOS	fossil		€ 52	CUBDE305.FRES	fresh		€ 63	CUBDE305.CSS	cream star		€ 63
CUBDE305.ECS	ecru		€ 52	CUBDE305.COPS	copper		€ 63	CUBDE305.FSS	mud grey star		€ 63
CUBDE305.TPS	taupe		€ 52	CUBDE305.PERS	pergamino		€ 63	CUBDE305.WSS	white star		€ 63
CUBDE305.BRS	brisa		€ 52	CUBDE305.ICES	ice		€ 63				
CUBDE305.GRS	grey		€ 52	CUBDE305.LIMS	limestone		€ 63				
CUBDE305.ANS	anthracite		€ 52								

CUB4040 Back cushion / Cuscino schienale 40×40

Removable Cushion / Cuscino sfoderabile
 Washable / Lavabile
 Waterproof gel-backing / Fodera impermeabile
Weight / Peso : 0,4 Kg

packaging / imballo  1  0,03  0,8 CM L 45 P 45 H 15

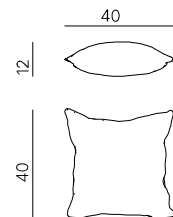
**Fabrics / Tessuti**

CODE / CODICE	BUSINESS	Q.S / P.C	PRICE	CODE / CODICE	SUNSET	Q.S / P.C	PRICE	CODE / CODICE	AVANT GARDE	Q.S / P.C	PRICE
CUB4040.FOS	fossil		€ 55	CUB4040.FRES	fresh		€ 66	CUB4040.CSS	cream star		€ 66
CUB4040.ECS	ecru		€ 55	CUB4040.COPS	copper		€ 66	CUB4040.FSS	mud grey star		€ 66
CUB4040.TPS	taupe		€ 55	CUB4040.PERS	pergamino		€ 66	CUB4040.WSS	white star		€ 66
CUB4040.BRS	brisa		€ 55	CUB4040.ICES	ice		€ 66				
CUB4040.GRS	grey		€ 55	CUB4040.LIMS	limestone		€ 66				
CUB4040.ANS	anthracite		€ 55								

Pillow



CUB5030 Back cushion / Cuscino schienale 50×30

Removable Cushion / Cuscino sfoderabile

Washable / Lavabile

Waterproof gel-backing / Fodera impermeabile

Weight / Peso : 0,6 Kg

packaging / imballo  1  0,03  1,2 CM L 55 P 35 H 15

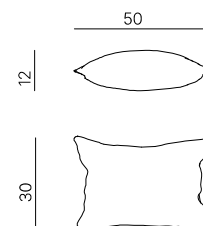

Fabrics / Tessuti

CODE / CODICE	BUSINESS	Q.S / P.C	PRICE	CODE / CODICE	SUNSET	Q.S / P.C	PRICE	CODE / CODICE	AVANT GARDE	Q.S / P.C	PRICE
CUB5030.FOS	fossil		€ 65	CUB5030.FRES	fresh		€ 79	CUB5030.CSS	cream star		€ 79
CUB5030.ECS	ecru		€ 65	CUB5030.COPS	copper		€ 79	CUB5030.FSS	mud grey star		€ 79
CUB5030.TPS	taupe		€ 65	CUB5030.PERS	pergamino		€ 79	CUB5030.WSS	white star		€ 79
CUB5030.BRS	brisa		€ 65	CUB5030.ICES	ice		€ 79				
CUB5030.GRS	grey		€ 65	CUB5030.LIMS	limestone		€ 79				
CUB5030.ANS	anthracite		€ 65								



CUB6040 Back cushion / Cuscino schienale 60×40

Removable Cushion / Cuscino sfoderabile

Washable / Lavabile

Waterproof gel-backing / Fodera impermeabile

Weight / Peso : 0,8 Kg

packaging / imballo  1  0,04  1,4 CM L 65 P 45 H 15

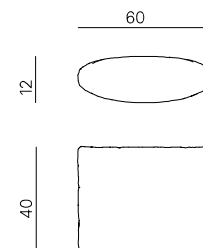

Fabrics / Tessuti

CODE / CODICE	BUSINESS	Q.S / P.C	PRICE	CODE / CODICE	SUNSET	Q.S / P.C	PRICE	CODE / CODICE	AVANT GARDE	Q.S / P.C	PRICE
CUB6040.FOS	fossil		€ 75	CUB6040.FRES	fresh		€ 94	CUB6040.CSS	cream star		€ 94
CUB6040.ECS	ecru		€ 75	CUB6040.COPS	copper		€ 94	CUB6040.FSS	mud grey star		€ 94
CUB6040.TPS	taupe		€ 75	CUB6040.PERS	pergamino		€ 94	CUB6040.WSS	white star		€ 94
CUB6040.BRS	brisa		€ 75	CUB6040.ICES	ice		€ 94				
CUB6040.GRS	grey		€ 75	CUB6040.LIMS	limestone		€ 94				
CUB6040.ANS	anthracite		€ 75								



Lighting / Illuminazione



frame / struttura

standard colours / colori standard



LU1000 Table lamp / Lampada da tavolo

Galvanized steel / Acciaio zincato
Dimmable, USB Type-C charging / Dimmerabile, ricarica USB Type-C
Weight / Peso : 1 Kg

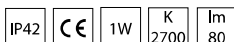

packaging / imballo 1 0,01 1,2 CM L 14 P 14 H 28

Frame / Struttura

CODE / CODICE	FRAME / STRUTTURA	Q.S / P.C	PRICE / €
LU1000.AG	ancient grey / grigio antico		€ 119
LU1000.BRO	bronze / bronzo		€ 119
LU1000.BS	ivory white / bianco perla		€ 119
LU1000.ME	mint green / verde menta		€ 119
LU1000.TC	terracotta / terracotta		€ 119
LU1000.NE	black / nero		€ 119

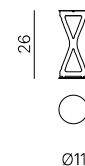
**LG002 Table lamp / Lampada da tavolo**

Galvanized Steel and aluminium / Acciaio zincato e alluminio
USB Type-C Charging / Ricarica USB Type-C
Weight / Peso : 0,6 Kg

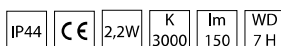

packaging / imballo 1 0,01 1 CM L 15 P 15 H 30

Frame / Struttura

CODE / CODICE	FRAME / STRUTTURA	Q.S / P.C	PRICE / €
LG002.NE	black / nero	•	€ 74

**LG004 Table lamp / Lampada da tavolo**

Galvanized Steel and aluminium / Acciaio zincato e alluminio
USB Type-C Charging / Ricarica USB Type-C
Weight / Peso : 0,7 Kg

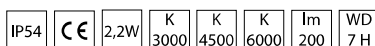

packaging / imballo 1 0,01 1 CM L 15 P 15 H 30

Frame / Struttura

CODE / CODICE	FRAME / STRUTTURA	Q.S / P.C	PRICE / €
LG004.BCU	matt white / bianco goffrato	•	€ 86

**LG006 Table lamp / Lampada da tavolo**

Galvanized Steel and aluminium / Acciaio zincato e alluminio
USB Type-C Charging / Ricarica USB Type-C
Weight / Peso : 0,7 Kg

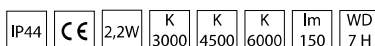

packaging / imballo 1 0,01 1 CM L 18,5 P 18,5 H 25

Frame / Struttura

CODE / CODICE	FRAME / STRUTTURA	Q.S / P.C	PRICE / €
LG006.NE	black / nero	•	€ 74

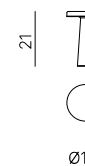

Lighting / Illuminazione

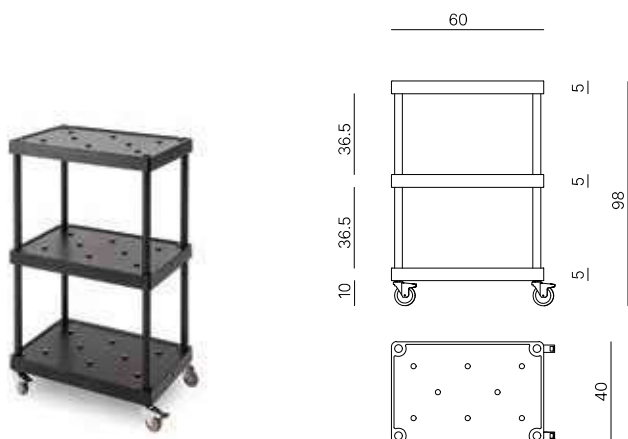

LGCT001 Charging Base / Piano di ricarica (for / per LG002, LG004, LG006)

Acrylic / Acrilico

8 charging point / 8 punti di ricarica

Weight / Peso : 5 Kg

packaging / imballo 1 0,02 6 CM L 7 P 68 H 43

Frame / Struttura

CODE / CODICE	FRAME / STRUTTURA	Q.S / P.C	PRICE / €
LGCT001	black / nero	•	€ 153



LGCT002 Charging base tubes / Montanti per piano di ricarica

Aluminium / Alluminio

4 pcs for box / 4 pezzi a scatola

Weight / Peso : 1,2 Kg

packaging / imballo 1 0,01 1,4 CM L 10 P 10 H 39

Frame / Struttura

CODE / CODICE	FRAME / STRUTTURA	Q.S / P.C	PRICE / €
LGCT002	black / nero	•	€ 21



LGCT003 Charging base wheels / Ruote per piano di ricarica

Galvanized steel and nylon / Acciaio zincato e nylon

4 pcs for box / 4 pezzi a scatola

Weight / Peso : 1 Kg

packaging / imballo 1 0,01 1 CM L 14 P 14 H 14

Frame / Struttura

CODE / CODICE	FRAME / STRUTTURA	Q.S / P.C	PRICE / €
LGCT003		•	€ 21



Carpets / Tappeti



fabrics / tessuti

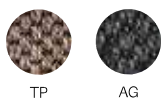

TAPCAM200 Outdoor Carpet / Tappeto da esterno ø 200

100% POLYPROPYLENE

Weight / Peso : 9 Kg

packaging / imballo 1 0,1 10 CM L 200 P 25 H 25

Frame / Struttura

CODE / CODICE	FRAME / STRUTTURA	Q.S / P.C	PRICE / €
TAPCAM200.AG	anthracite	•	€ 592
TAPCAM200.TP	taupe	•	€ 592

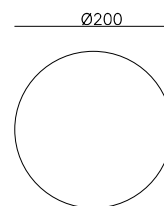

TAPCAM2015 Outdoor Carpet / Tappeto da esterno 200×150

100% POLYPROPYLENE

Weight / Peso : 9 Kg

packaging / imballo 1 0,1 10 CM L 200 P 25 H 25

Frame / Struttura

CODE / CODICE	FRAME / STRUTTURA	Q.S / P.C	PRICE / €
TAPCAM2015.AG	anthracite	•	€ 456
TAPCAM2015.TP	taupe	•	€ 456

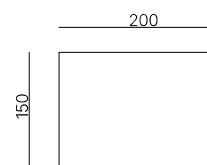

TAPCAM2030 Outdoor Carpet / Tappeto da esterno 300×200

100% POLYPROPYLENE

Weight / Peso : 10 Kg

packaging / imballo 1 0,1 11 CM L 200 P 25 H 25

Frame / Struttura

CODE / CODICE	FRAME / STRUTTURA	Q.S / P.C	PRICE / €
TAPCAM2030.AG	anthracite	•	€ 864
TAPCAM2030.TP	taupe	•	€ 864

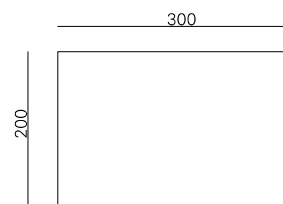

Cover



fabrics / tessuti



GR

More information on colors and fabrics from page 194 / Più informazioni su colori e tessuti da pagina 194

COV9090 Cover / Copertura 90×90xH90

Polyester Ripstop laminated with film / Poliestere antistrappo laminato
 Water and dirt repellent on both sides / Idrorepellente e antimacchia su entrambi i lati
 Breathable / Traspirante

Frame / Struttura

CODE / CODICE	Q.S / P.C	PRICE / €
COV9090	•	€ 165

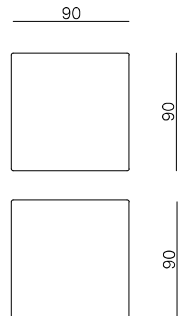
**COV17090 Cover / Copertura 170×90xH90**

Polyester Ripstop laminated with film / Poliestere antistrappo laminato
 Water and dirt repellent on both sides / Idrorepellente e antimacchia su entrambi i lati
 Breathable / Traspirante

Frame / Struttura

CODE / CODICE	Q.S / P.C	PRICE / €
COV17090	•	€ 189

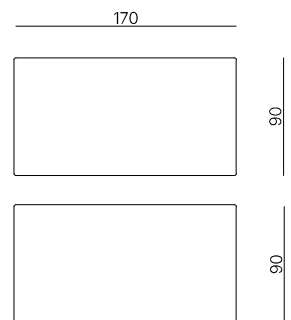
**COV24090 Cover / Copertura 240×90xH90**

Polyester Ripstop laminated with film / Poliestere antistrappo laminato
 Water and dirt repellent on both sides / Idrorepellente e antimacchia su entrambi i lati
 Breathable / Traspirante

Frame / Struttura

CODE / CODICE	Q.S / P.C	PRICE / €
COV24090	•	€ 212

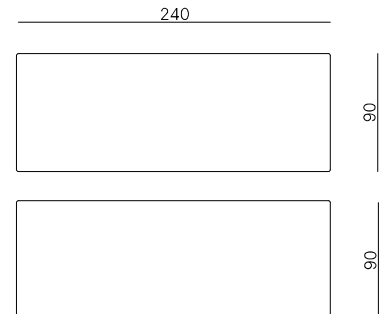

ITALIAN PRODUCTION, MATERIALS AND FINISHES

Produzione italiana, materiali e finiture

Production / Produzione	186
Metals / Metalli	188
Cushions / Cuscini	196
Fabrics / Tessuti	198
Ropes / Corde	206
Batyline	210
HPL	216



TECHNOLOGICAL PRECISION AND CRAFTSMANSHIP CARE

Precisione tecnologica e cura artigianale

— The production process is carried out and controlled internally: from cutting the materials to their transformation, from protective treatments to painting systems, up to packaging and storage. Each phase of the process is designed to ensure precision in raw material processing, attention to details, resistance to weather conditions and maximum safety during transport. Vermobil bases its entire production on a winning combination: advanced technologies and top-level craftsmanship expertise.

— La lavorazione viene eseguita e controllata internamente: dal taglio dei materiali alla loro trasformazione, dai trattamenti protettivi ai sistemi di verniciatura, fino all'imballaggio e allo stoccaggio. Ogni fase del processo è pensata per garantire precisione nella lavorazione delle materie prime, cura dei dettagli, resistenza agli agenti atmosferici e massima sicurezza nel trasporto. Vermobil impronta l'intera produzione su un binomio vincente: tecnologie avanzate e competenza artigianale del massimo livello.

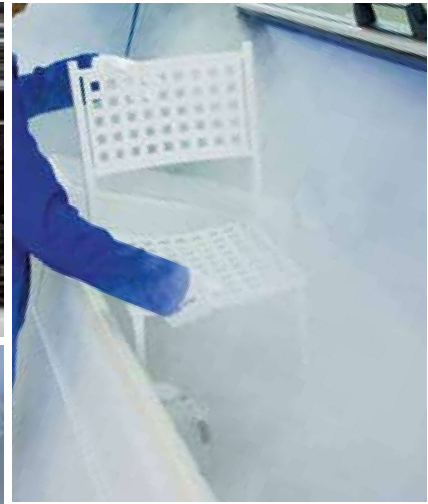

OUR METALS, GUARANTEED RESISTANCE

I nostri Metalli, resistenza garantita

— Outdoor metal furniture requires minimal maintenance. The powder coatings applied to steel and aluminum ensure high resistance to weather conditions and reduce the adhesion of dirt. However, it is essential to regularly check the integrity of the steel surfaces: any damage should be treated with localized sanding, application of a thin layer of anti-rust, and a final touch-up with paint. Timely intervention is essential to maintain its effectiveness over time.

— I mobili da esterno in metallo richiedono interventi manutentivi minimi. Le finiture a polvere, applicate su acciaio e alluminio, assicurano un'elevata resistenza agli agenti atmosferici e riducono l'adesione di sporco. È tuttavia fondamentale controllare l'integrità delle superfici in acciaio periodicamente: eventuali danneggiamenti devono essere trattati con carteggiatura localizzata, applicazione di un sottile strato di antiruggine e successivo ritocco con vernice. Un intervento tempestivo è fondamentale per preservarne l'efficacia nel tempo.



GALVANIZED STEEL / acciaio zincato

FEATURES

Iron-carbon alloy with a percentage of carbon less than 2%. The steel used in Vermobil products is treated to resist atmospheric agents, thanks to the galvanizing process.

ENVIRONMENT

Steel produced from recycled material does not show any degradation in mechanical properties, thus being identical to the "new" material.

It's never consumed but continuously transformed through recycling processes, which is why it's considered a "permanent material", at the base of the circular economy.

USE AND MAINTENANCE

To ensure the maximum durability of the product, it is recommended to store it during the winter season in closed, dry environments to prevent humidity from causing condensation. If the products are located in sea areas, it is recommended to clean the surfaces every two or three months with mild detergents and then protect them with vaseline oil. **IMPORTANT:** Avoid leaving waterproof synthetic covers on tabletops for long periods, as condensation may damage the finish.

CARATTERISTICHE

Lega di ferro e carbonio con percentuale di carbonio inferiore al 2%. L'acciaio utilizzato nei prodotti Vermobil è trattato per resistere agli agenti atmosferici tramite processo di zincatura.

AMBIENTE

L'acciaio prodotto da materiale di riciclo non presenta alcun degrado nelle proprietà meccaniche, risultando così indistinguibile dal materiale "nuovo". Non viene mai consumato ma continuamente trasformato attraverso i processi di riciclo, per questo è considerato un "materiale permanente", alla base dell'economia circolare.

USO E MANUTENZIONE

Per garantire la massima durata del prodotto, è consigliabile conservarlo durante la stagione invernale in ambienti chiusi e asciutti, evitando che l'umidità provochi condensa. Se i prodotti sono situati in zone di mare, è opportuno pulire le superfici ogni due o tre mesi con detergenti delicati e proteggerle successivamente con olio di vaselina. **IMPORTANTE:** evitare di lasciare teli sintetici impermeabili sui piani dei tavoli per lunghi periodi, poiché la condensa potrebbe danneggiare la verniciatura.

ENAMELED STEEL / acciaio smaltato

FEATURES

Enameled steel is a highly versatile material that combines the exceptional mechanical properties of steel with the aesthetic and protective qualities of enamel. The production process involves applying a vitreous enamel layer - composed of silicates and metallic oxides - onto the steel surface, which is then heated at high temperatures. This process creates a durable, non-porous finish that is highly resistant to impact, scratches, and abrasion. The enamel layer acts as a protective barrier against corrosion and wear, making enameled steel an ideal choice for applications requiring high durability and frequent use.

ENVIRONMENT

Enameled steel is a fully recyclable material with no negative environmental impact. Both the steel substrate and the vitreous enamel coating can be recovered and reintroduced into the production cycle, promoting the circular economy while simultaneously reducing the need for the extraction of new natural resources.

USE AND MAINTENANCE

The smooth, non-porous surface of enamel prevents the adhesion of bacteria, germs, and dirt, ensuring high hygienic standards and making cleaning effortless. Thanks to these properties, the material is easy to maintain and can be kept perfectly clean using only damp cloths and mild, neutral detergents.

CARATTERISTICHE

L'acciaio smaltato è un materiale altamente versatile che unisce le eccellenti proprietà meccaniche dell'acciaio alle caratteristiche estetiche e protettive dello smalto. Il processo di produzione prevede l'applicazione di uno strato di smalto vetroso - una composizione di silicati e ossidi metallici - sulla superficie dell'acciaio, che viene successivamente sottoposto a cottura ad alte temperature. Tale trattamento conferisce al materiale una finitura durevole, priva di porosità, che risulta particolarmente resistente a urti, graffi e abrasioni. Lo smalto, infatti, funge da barriera protettiva contro la corrosione e l'usura, rendendo l'acciaio smaltato una scelta ideale per applicazioni ad uso intensivo.

AMBIENTE

L'acciaio smaltato è un materiale interamente riciclabile, senza alcun impatto negativo sull'ambiente. Sia l'acciaio che il rivestimento vetroso possono essere recuperati e reintrodotti nel ciclo produttivo, promuovendo l'economia circolare e riducendo al contempo la necessità di estrarre nuove risorse naturali.

USO E MANUTENZIONE

La superficie liscia e non porosa dello smalto impedisce l'adesione di batteri, germi e sporco, conferendogli caratteristiche di elevata igiene e facilitando le operazioni di pulizia. Grazie a queste proprietà, è possibile mantenere il materiale perfettamente pulito anche utilizzando semplici panni umidi e detergenti neutri.

STAINLESS STEEL / acciaio inox AISI 316L

FEATURES

AISI 316L stainless steel is a metal alloy highly valued for its corrosion resistance and versatility. Thanks to the presence of molybdenum in its composition, it is particularly suitable for aggressive environments such as marine settings.

ENVIRONMENT

Stainless steel is a champion of sustainability.

Endlessly recycled without losing quality, it drastically reduces emissions and preserves natural resources.

USE AND MAINTENANCE

The best way to ensure maximum product durability is to store it during the winter season in closed and dry places to prevent moisture from creating condensation. If the products are in a seaside area, it is advisable to clean the surfaces every two/three months with mild detergents, then protect them with vaseline oil. **IMPORTANT:** Do not leave synthetic waterproof covers on tabletops for prolonged periods.

Condensation could damage the paint.

CARATTERISTICHE

L'acciaio inox AISI 316L è una lega metallica molto apprezzata per la sua resistenza alla corrosione e la versatilità. Grazie alla presenza di molibdeno nella sua composizione, è particolarmente indicato per ambienti aggressivi come quelli marini.

AMBIENTE

L'acciaio inox è un campione di sostenibilità.

Riciclato all'infinito senza perdere qualità, riduce drasticamente le emissioni e preserva le risorse naturali.

USO E MANUTENZIONE

Il modo migliore per assicurare la massima durata al prodotto è conservarlo durante la stagione invernale in luoghi chiusi e asciutti, per evitare che l'umidità crei condensa. Nel caso in cui i prodotti si trovino in una zona di mare è opportuno pulire le superfici ogni due/tre mesi con detergenti proteggendole poi con olio di vaselina.

IMPORTANTE: sui piani dei tavoli, non lasciare teli sintetici impermeabili per tempi prolungati.

La condensa potrebbe danneggiare la verniciatura.

ALUMINIUM / alluminio

FEATURES

Alloy 6060 and 6082: aluminum, magnesium, and silicon alloys, ideal for furniture due to their lightness and excellent corrosion resistance.

RECYCLABLE

It is a 100% recyclable material, it can be reused indefinitely, without losing its characteristics.

USE AND MAINTENANCE

The best way to ensure maximum product durability is to store it during winter in closed and dry places, to prevent humidity from creating condensation. If the furniture is placed in a sea area, it is recommended to clean the surfaces every two or three months with mild detergents, then apply a protective layer of Vaseline oil. **IMPORTANT:** do not leave waterproof synthetic sheets over the tabletops for a long time. Condensation could damage the paint.

CARATTERISTICHE

Lega 6060 e 6082: leghe di alluminio, magnesio e silicio, ideali per l'arredamento grazie alla loro leggerezza e all'eccellente resistenza alla corrosione.

RICICLABILE

È un materiale riciclabile al 100%, può essere riutilizzato all'infinito, senza perdere le proprie caratteristiche.

USO E MANUTENZIONE

Il modo migliore per assicurare la massima durata al prodotto è conservarlo durante la stagione invernale in luoghi chiusi e asciutti, per evitare che l'umidità crei condensa. Nel caso in cui i prodotti si trovino in una zona di mare è opportuno pulire le superfici ogni tre mesi con detergenti delicati, proteggendole poi con olio di vaselina. **IMPORTANTE:** sui piani dei tavoli, non lasciare teli sintetici impermeabili per tempi prolungati. La condensa potrebbe danneggiare la verniciatura.

STANDARD METAL COLOURS / COLORI METALLO STANDARD

Metal coating is carried out using polyester thermosetting powders compliant with Qualicoat Class 1 and Class 2 standards.

An additional treatment before finishing, with the application of an epoxy primer, is also available.

La verniciatura dei metalli viene eseguita con polveri termoindurenti in poliestere, conformi agli standard Qualicoat classe 1 e classe 2.

È possibile effettuare un trattamento aggiuntivo prima della finitura con l'applicazione di fondo epossidico.

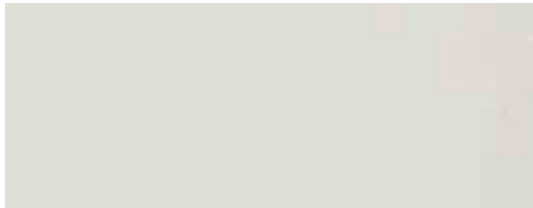

BS IVORY WHITE / BIANCO PERLA

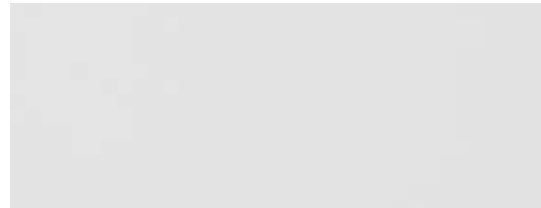

BCU MATT WHITE / BIANCO GOFFRATO



FA MUD GREY / FANGO



CO CORTEN / CORTEN



NE BLACK / NERO **RAL 9005**



BRO BRONZE / BRONZO



AG ANCIENT GREY / GRIGIO ANTICO



ME MINT GREEN / MENTA



TC TERRACOTTA / TERRACOTTA **RAL 8012**

*All colours featured in this catalogue, including illustrations and pictures, are merely illustrative. For an accurate colour selection, please refer to our sample box.

*Tutti i colori presenti in questo catalogo, comprese illustrazioni e fotografie, sono da considerarsi puramente rappresentativi. Per una scelta accurata dei colori, si prega di fare riferimento alla nostra cartella campioni.

SPECIAL METAL COLOURS / COLORI METALLO SPECIALE

Metal coating is carried out using polyester thermosetting powders compliant with Qualicoat Class 1 and Class 2 standards.

An additional treatment before finishing, with the application of an epoxy primer, is also available. Delivery in 8 weeks.

La verniciatura dei metalli viene eseguita con polveri termoindurenti in poliestere, conformi agli standard Qualicoat classe 1 e classe 2.

È possibile effettuare un trattamento aggiuntivo prima della finitura con l'applicazione di fondo epossidico. Consegna in 8 settimane.

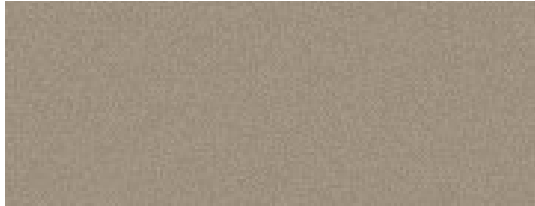

BE BEIGE / BEIGE RAL 1019



GI YELLOW / GIALLO RAL 1023



RR RED / ROSSO RAL 3003



CU CURRY / CURRY RAL 1027



VDE SAGE GREEN / VERDE SALVIA RAL 6021



AR ORANGE / ARANCIO RAL 2011



BLC COBALT BLUE / BLU COBALTO RAL 5013

ENAMELED METAL COLOURS / COLORI METALLO SMALTATO

A layer of vitreous enamel is applied to the surface of the steel and then fired at high temperatures.

Sulla superficie dell'acciaio viene applicato uno strato di smalto vetroso e, successivamente, viene cotto ad alte temperature.

verstone[®]
ENAMELED FINISHES



EBS ENAMELED IVORY WHITE / BIANCO PERLA SMALTATO



ENE ENAMELED BLACK / NERO SMALTATO



ETC ENAMELED TERRACOTTA / TERRACOTTA SMALTATO



CUSHION FABRICS

tessuti cuscini

— Vermobil cushions are made with high-quality fabrics that are UV-resistant and waterproof thanks to an internal PVC coating. The technical weave promotes breathability of the padding, helping to prevent mold formation. The fabrics' stain-resistant properties make them easy to clean while ensuring complete hygiene.

Vermobil cushions are made of a polyurethane foam available in different densities depending on the model, wrapped in polyester fiber coupled with TNT. This structure ensures long-lasting durability, facilitates removal and reinsertion of the filling, and provides a soft, comfortable feel. The combination of density and thickness defines the cushions' comfort level, while the high elasticity of the material ensures a stable and durable shape over time.

— I cuscini Vermobil sono realizzati con tessuti di alta qualità, resistenti ai raggi UV e impermeabili grazie alla spalmatura interna in PVC. L'intreccio tecnico favorisce la traspirazione dell'imbottitura, prevenendo la creazione di muffe. I tessuti, grazie alle loro proprietà antimacchia, risultano facili da pulire e garantiscono un'igiene completa.

I cuscini Vermobil sono costituiti da un interno in poliuretano espanso, disponibile in diverse densità a seconda del modello, rivestito da fibra di poliestere accoppiata a TNT. Questa struttura garantisce durata nel tempo, facilita le operazioni di sfoderamento e rinsacco, e conferisce al cuscino una piacevole morbidezza al tatto. La combinazione di densità e spessore definisce il livello di comfort dei cuscini, mentre l'elevata elasticità del materiale garantisce una forma stabile e duratura nel tempo.



BUSINESS FABRICS / tessuti business

— **100% Solution Dyed Acrylic.** The fabrics used for Vermobil cushions are designed to meet the highest standards of cleanliness and hygiene, both for residential use and in the contract sector. Thanks to their stain-resistant properties, they are extremely easy to clean. Depending on the type of dirt, simply using water and detergents is enough to achieve impeccable results. This allows for deep cleaning, ensuring complete hygiene and the elimination of microorganisms, viruses, and bacteria.

— **100% Acrilico Tinto in Massa.** I tessuti utilizzati per i cuscini Vermobil sono studiati per soddisfare le esigenze di pulizia e igiene, sia in ambito domestico che nel settore contract. Grazie alle loro proprietà antimacchia, risultano estremamente facili da pulire. A seconda del tipo di sporco, è sufficiente utilizzare acqua e detersivi per ottenere risultati impeccabili. Questo consente una pulizia profonda, garantendo un'igiene completa e l'eliminazione di microrganismi, virus e batteri.

	ANS - FOS - ECS - BRS - GRS - TPS
Peso Weight	325 g/m ²
Finitura Finish	 Impermeabile Waterproof  Antimacchia Anti-stain
Solidità dei colori Colour fastness to light	7-8/8 UNE EN ISO 105-B02:2014
Utilizzi Uses	
Istruzioni per il lavaggio Cleaning instructions	

Valori suscettibili alla tolleranza di +/- 5%. Sensitive values of tolerance +/- 5%.

— Qualities / Qualità





ANS ANTHRACITE / ANTRACITE



FOS FOSSIL



ECS ECRU



BRS BRISA



GRS GREY / GRIGIO



TPS TAUPE / TALPA

*All colours featured in this catalogue, including illustrations and pictures, are merely illustrative. For an accurate colour selection, please refer to our sample box.

*Tutti i colori presenti in questo catalogo, comprese illustrazioni e fotografie, sono da considerarsi puramente rappresentativi. Per una scelta accurata dei colori, si prega di fare riferimento alla nostra cartella campioni.

AVANT-GARDE FABRICS / tessuti avant-garde

— **100% polypropylene**. The fabrics used for Vermobil cushions are designed to meet the highest standards of cleanliness and hygiene, both for residential use and in the contract sector. Thanks to their stain-resistant properties, they are extremely easy to clean. Depending on the type of dirt, simply using water and detergents is enough to achieve impeccable results. This allows for deep cleaning, ensuring complete hygiene and the elimination of microorganisms, viruses, and bacteria.

— **100% polipropilene**. I tessuti utilizzati per i cuscini Vermobil sono studiati per soddisfare le esigenze di pulizia e igiene, sia in ambito domestico che nel settore contract. Grazie alle loro proprietà antimacchia, risultano estremamente facili da pulire. A seconda del tipo di sporco, è sufficiente utilizzare acqua e detersivi per ottenere risultati impeccabili. Questo consente una pulizia profonda, garantendo un'igiene completa e l'eliminazione di microrganismi, virus e batteri.

	WSS - CSS - FSS
Peso Weight	526 g/m ²
Solidità dei colori Colour fastness to light	8/8 ISO 105-B02
Resistenza alla trazione Tensile strength	Min. 350N EN ISO 13934-1:2013
Resistenza allo strappo Tear strength	Min. 20N EN ISO 13937-3:2000
Istruzioni per il lavaggio Cleaning instructions	

— Qualities / Qualità





WSS WHITE STAR



CSS CREAM STAR



FSS MUD GREY STAR



















*All colours featured in this catalogue, including illustrations and pictures, are merely illustrative. For an accurate colour selection, please refer to our sample box.

*Tutti i colori presenti in questo catalogo, comprese illustrazioni e fotografie, sono da considerarsi puramente rappresentativi. Per una scelta accurata dei colori, si prega di fare riferimento alla nostra cartella campioni.

SUNSET FABRICS / tessuti sunset

— **100% Solution Dyed Acrylic.** The fabrics used for Vermobil cushions are designed to meet the highest standards of cleanliness and hygiene, both for residential use and in the contract sector. Thanks to their stain-resistant properties, they are extremely easy to clean. Depending on the type of dirt, simply using water and detergents is enough to achieve impeccable results. This allows for deep cleaning, ensuring complete hygiene and the elimination of microorganisms, viruses, and bacteria.

— **100% Acrilico Tinto in Massa.** I tessuti utilizzati per i cuscini Vermobil sono studiati per soddisfare le esigenze di pulizia e igiene, sia in ambito domestico che nel settore contract. Grazie alle loro proprietà antimacchia, risultano estremamente facili da pulire. A seconda del tipo di sporco, è sufficiente utilizzare acqua e detersivi per ottenere risultati impeccabili. Questo consente una pulizia profonda, garantendo un'igiene completa e l'eliminazione di microrganismi, virus e batteri.

	LIMS - FRES - COPS - PERS - ICES
Peso Weight	495 g/m ²
Finitura Finish	 Impermeabile Waterproof  Antimacchia Anti-stain  No PFAS Eco-Shield
Solidità dei colori Colour fastness to light	7-8/8 UNE EN ISO 105-B02:2014
Utilizzi Uses	       
Istruzioni per il lavaggio Cleaning instructions	    

Valori suscettibili alla tolleranza di +/- 5%. Sensitive values of tolerance +/- 5%.

— Qualities / Qualità





LIMS LIMESTONE



FRES FRESH



COPS COPPER

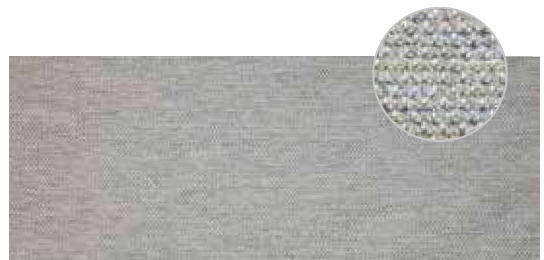

PERS PERGAMINO

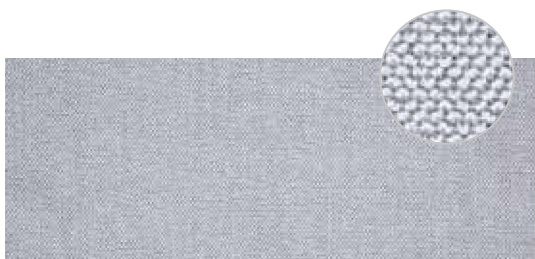







ICES ICE

SUNSHADE FABRICS / tessuti ombrelloni

__ **100% Solution-Dyed Acrylic.** These fabrics are specifically designed for the production of medium and large sunshades. They provide excellent UV protection and long-lasting durability, ensuring enhanced thermal and visual comfort in both private and public outdoor spaces. Resistant to fungi, mold, and salt, they retain their appearance without the need for complex maintenance or frequent washing. Any stains on the fabrics used in our sunshades can be removed with a simple solution of water (maximum 40°C) and mild soap, gently brushed and thoroughly rinsed. Allow the fabric to air dry. Do not use electric dryers and do not steam iron.

__ **100% Acrilico Tinto in Massa.** Questi tessuti sono specificatamente studiati per la realizzazione di ombrelloni da giardino di medie e grandi dimensioni. Garantiscono protezione dai raggi UV e durata nel tempo assicurando un miglior comfort termico e visivo sia in ambienti privati che in ambienti pubblici. Inattaccabili da funghi, muffe e salsedine, mantengono la loro bellezza senza necessitare di complicate manutenzioni o frequenti lavaggi. Le macchie sui tessuti utilizzati nei nostri ombrelloni possono essere eliminate con una semplice soluzione di acqua (non più di 40°C) e sapone, spazzolando e risciacquando accuratamente. Lasciare asciugare il tessuto all'aria aperta. Non asciugare con apparecchi elettrici e non stirare con vapore.

	ECR - GRE - ANT
Peso Weight	280 g/m ²
Finitura Finish	 Impermeabile Waterproof  Antimacchia Anti-stain
Solidità dei colori Colour fastness to light	4/5 UNI EN ISO 105 B04
Istruzioni per il lavaggio Cleaning instructions	    



ECR 151/15



GRE 94/15



ANT 97



ROPES

corde

The Vermobil synthetic rope is made from an Italian polyolefin fiber, patented for outdoor applications, composed of 65% Olyna and 35% polyester. The fiber is completely waterproof, stain-resistant, antibacterial, and highly resistant to UV rays, chlorine, and humidity. Additionally, it is 100% recyclable and non-toxic, in compliance with OEKO-TEX Standard 100 – Class 1 certification. Maintenance: to clean rope surfaces, it is recommended to use lukewarm water (maximum temperature 40°C) and a neutral soap. Gently scrub with a soft cloth and rinse carefully. Repeat the process if necessary. To speed up the drying process, a hair dryer may be used, keeping it at a minimum distance of 10 cm from the surface. To remove dust and other residues from the rope weave, it is recommended to use a vacuum cleaner with a brush nozzle. Storage: Vermobil rope products must be stored in enclosed, dry places and protected with breathable fabric covers.

La corda sintetica Vermobil è realizzata con una fibra poliolefinica italiana, brevettata per applicazioni outdoor, composta al 65% da Olyna e al 35% da poliestere. La fibra è totalmente impermeabile, antimacchia, antibatterica e altamente resistente ai raggi UV, al cloro e all'umidità. Inoltre, è 100% riciclabile e atossica, in conformità con la certificazione OEKO-TEX Standard 100 – Classe 1. Manutenzione: per la pulizia delle superfici in corda si consiglia l'utilizzo di acqua tiepida (temperatura massima 40°C) e sapone neutro. Strofinare delicatamente con un panno morbido e risciacquare accuratamente. Se necessario, ripetere l'operazione. Per velocizzare il processo di asciugatura è possibile usare il getto d'aria calda di un phon ad una distanza minima di 10 centimetri. Per eliminare polvere e altri residui dall'intreccio della corda si consiglia l'utilizzo di un'aspirapolvere con ugello a spazzola. Conservazione: i prodotti Vermobil in corda vanno conservati in luoghi chiusi e asciutti, proteggendoli con teli in tessuto traspirante.

TECHNICAL DATA SHEET AND OLYNA SYNTHETIC ROPE CERTIFICATIONS SCHEMA TECNICA E CERTIFICAZIONI CORDA SINTETICA OLYNA

RESISTANCE TO SUNLIGHT RESISTENZA AI RAGGI SOLARI	UNI EN ISO 105 – B04 UNI EN ISO 105 – B04	>7 (MAX 8 SCALA DEI BLU) >4-5 (MAX 5 SCALA DEI GRIGI)
RESISTANCE TO WEAR RESISTENZA ALL'USURA	UNI EN ISO 12947	>25.000 RUBS
PILLING PILLING	UNI EN ISO 12945-2	5 (MAX 5)
COLOR RESISTANCE TO DRY CLEANING RESISTENZA DEL COLORE AL LAVAGGIO A SECCO	UNI EN ISO 105 – X12	5 (MAX 5)
COLOR RESISTANCE TO WASHING WITH WATER RESISTENZA DEL COLORE AL LAVAGGIO CON ACQUA	UNI EN ISO 105 – X12	4-5 (MAX 5)
RESISTANCE TO THE POOL ENVIRONMENT RESISTENZA ALL'AMBIENTE PISCINA	UNI EN ISO 105 – E03w	5 (MAX 5)
RESISTANCE TO LIQUIDS (STAIN) RESISTENZA AI LIQUIDI (MACCHIA)	UNI EN ISO 12720	5 (MAX 5) VINO ROSSO, CREMA SOLARE DETERGENTE, OLIO D'OLIVA TE, BIRRA
VARIATION IN DIMENSIONS DURING WASHING VARIAZIONE DELLE DIMENSIONI DURANTE IL LAVAGGIO	UNI EN 25077:1996	< 1%



SOFA, CHAIR, ARMCHAIR / salotti, sedie, poltrone

Composition: 65% Olyna Outdoor, 35% Polyester Bacteria resistant, Anti-mould, Washable, Recyclable, Antiallergic, washable at 30°, Chlorine Resistant, Outdoor.

Composizione: 65% Olyna Outdoor, 35% Poliestere Antibatterica, antimuffa, riciclabile, antiallergica, lavabile a 30°, resistente al cloro, resistente ai raggi solari.

SOFA SALOTTI

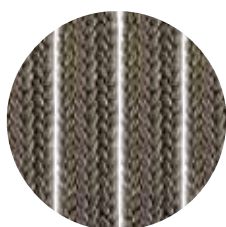

TIPO 1 / TIPO 1
25mm

CHAIRS AND ARMCHAIRS SEDIE E POLTRONE



TIPO 2 / TIPO 2
15mm



NE NERO / BLACK (N°5)



FA FANGO / MUD GREY (N°4)



TA TALPA / TAUPE (N°9)



NE NERO / BLACK (N°5)



FA FANGO / MUD GREY (N°4)



TA TALPA / TAUPE (N°9)

ROPE ARMREST FELLINI LINE / corde bracciolo linea fellini

Composition: 65% Olyna Outdoor, 35% Polyester Bacteria resistant, Anti-mould, Washable, Recyclable, Antiallergic, washable at 30°, Chlorine Resistant, Outdoor.

Composizione: 65% Olyna Outdoor, 35% Poliestere Antibatterica, antimuffa, riciclabile, antiallergica, lavabile a 30°, resistente al cloro, resistente ai raggi solari.

ARMREST FELLINI LINE BRACCIOLO LINEA FELLINI



FA MUD GREY
FANGO



NE BLACK
NERO



FE305 NE BLACK / NERO



FE304 FA MUD GREY / FANGO



*All colours featured in this catalogue, including illustrations and pictures, are merely illustrative. For an accurate colour selection, please refer to our sample box.

*Tutti i colori presenti in questo catalogo, comprese illustrazioni e fotografie, sono da considerarsi puramente rappresentativi. Per una scelta accurata dei colori, si prega di fare riferimento alla nostra cartella campioni.

BATYLINE

__ Polyester fiber coated with a PVC sheath resistant to weather conditions and UV rays. Avoid contact with greasy substances or dyes, as the coating material may absorb them, compromising the fiber structure and causing permanent stains. For frequent cleaning, use water and colorless, non-abrasive liquid detergents with a neutral pH. For stubborn stains, allow the detergent to act for 15–30 minutes, then rinse with water at a maximum temperature of 30°C. When cleaning with pressure devices, keep the nozzles at least 70 cm away from the surface to be treated. For periodic or intensive cleaning, it is recommended to use a PVC regenerating stain remover: apply the product to the surface and let it sit for 15–30 minutes, then scrub with a stiff-bristled laundry brush. Finally, rinse thoroughly with running water. **IMPORTANT:** avoid contact of the detergent with painted areas.

__ Fibra di poliestere rivestita con una guaina in PVC resistente agli agenti atmosferici e ai raggi UV. Evitare il contatto con sostanze grasse o coloranti, poiché il materiale di rivestimento potrebbe assorbirle, compromettendo la struttura del filato e causando macchie indelebili. Per lavaggi frequenti, usare acqua e detersivi liquidi, incolore, non abrasivi e a pH neutro. Per macchie ostinate, lasciare agire il detersivo alcuni minuti e risciacquare a massimo 30°C. Per la pulizia con apparecchi a pressione, mantenere i diffusori ad almeno 70 cm di distanza dalla superficie da trattare. Per lavaggi periodici o straordinari si consiglia l'uso di uno smacchiatore rigenerante per PVC: applicare il prodotto sulla superficie e lasciarlo agire per 15–30 minuti, quindi strofinare con una spazzola da bucato a setole dure. Infine, risciacquare abbondantemente con acqua corrente. **IMPORTANTE:** evitare che il detersivo entri in contatto con le parti verniciate.



BATYLINE BASIC

__ **Polyester fibre.** Avoid contact with grease and dyes. For frequent cleaning, use water and liquid detergents that are colorless, nonabrasive, and pH-neutral. For stubborn stains, let the detergent sit for a few minutes, then rinse at a maximum of 30°C. When using pressure washers, maintain a minimum distance of 70 cm. For deep cleaning, use a PVC restoring stain remover: let it act for 15–30 minutes, scrub with a hard-bristle brush, and rinse. Avoid contact of the detergent with unaffected areas.

__ **Fibra di poliestere.** Evitare contatto con grassi e coloranti. Per lavaggi frequenti usare acqua e detersivi liquidi incolori, non abrasivi e a pH neutro. Per macchie ostinate, lasciare agire il detergente alcuni minuti e risciacquare a massimo 30°C. Con apparecchi a pressione, mantenere almeno 70 cm di distanza. Per pulizie profonde usare smacchiatore rigenerante per PVC: lasciare agire 15-30 minuti, strofinare con spazzola a setole dure e risciacquare. Evitare che il detergente tocchi aree non interessate.

	BCO - TO - NE	ECRU
Peso Weight	560 g/m ²	735 g/m ²
Resistenza alla trazione (ordito/trama) Tensile strength (warp/weft)	≥260/≥225 daN/5 cm EN ISO 1421	≥412/≥392 daN/5 cm EN ISO 1421
Allungamento sotto carico 20 daN (ordito/trama) Elongation under load 20 daN (warp/weft)	≤3,2% - ≤1,3% EN ISO 1421	≤3,2% - ≤1,3% EN ISO 1421
Resistenza dei colori all'abrasione Abrasion resistance	>100,000 cycles EN ISO 14465	>100,000 cycles EN ISO 14465
Resistenza alle intemperie Weather resistance	GS=4 for 700 h ASTM G154	GS=4 for 700 h ASTM G154
Resistenza alla fatica Fatigue test resistance	>200,000 cycles/1,000 N EN 1728:2000 EN 15373:2007	>200,000 cycles/1,000 N EN 1728:2000 EN 15373:2007

Valori suscettibili alla tolleranza di +/- 5%. Sensitive values of tolerance +/- 5%.

__ Qualities / Qualità



PRESTAZIONI ELEVATE
HIGH PERFORMANCE



CONFORTEVOLE
COMFORTABLE



RICICLABILE
RECYCLABLE



RESISTENZA UV
UV RESISTANT



MORBIDO
SOFT



FILATO INTELLIGENTE
SMART YARN



DUREVOLE
DURABLE STRONG



RESISTENTE ALLE INTEMPERIE
WEATHER-RESISTANT



LAVABILE
WASHABLE



PRIVO DI FTALATI
PHTHALATE FREE



ANTIMUFFA
MOULD RESISTANT



TEMP. OPERATIVA ESTREMA
EXTREME WORKING TEMP.



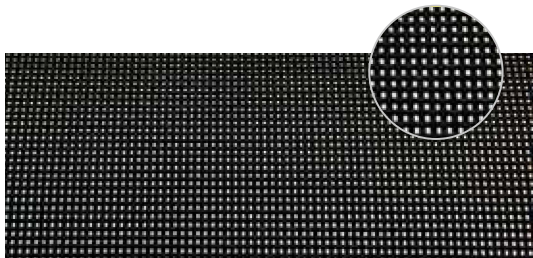

NE NERO / BLACK

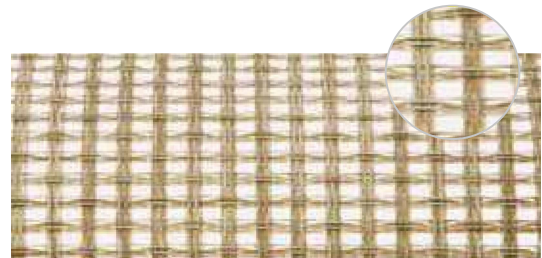

ECRU ECRU / ECRU

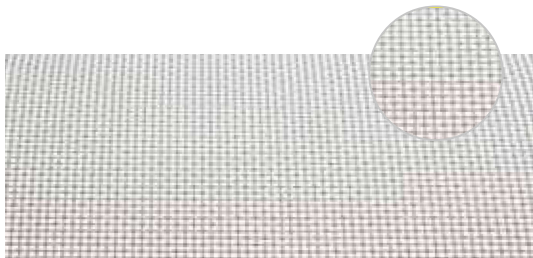

BCO BIANCO / WHITE

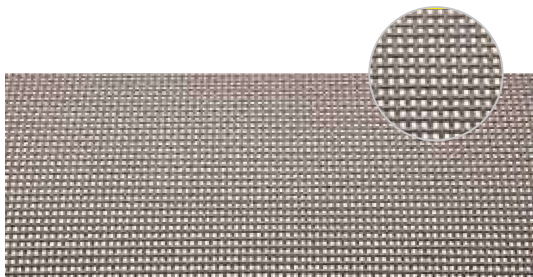



TO TORTORA / TAUPE

BATYLINE EDEN

— **Polyester fibre.** Avoid contact with grease and dyes. For frequent cleaning, use water and liquid detergents that are colorless, nonabrasive, and pH-neutral. For stubborn stains, let the detergent sit for a few minutes, then rinse at a maximum of 30°C. When using pressure washers, maintain a minimum distance of 70 cm. For deep cleaning, use a PVC restoring stain remover: let it act for 15–30 minutes, scrub with a hard-bristle brush, and rinse. Avoid contact of the detergent with unaffected areas.

— **Fibra di poliestere.** Evitare contatto con grassi e coloranti. Per lavaggi frequenti usare acqua e detersivi liquidi incolore, non abrasivi e a pH neutro. Per macchie ostinate, lasciare agire il detergente alcuni minuti e risciacquare a massimo 30°C. Con apparecchi a pressione, mantenere almeno 70 cm di distanza. Per pulizie profonde usare smacchiatore rigenerante per PVC: lasciare agire 15-30 minuti, strofinare con spazzola a setole dure e risciacquare. Evitare che il detergente tocchi aree non interessate.

	STL - CRC - OCR - ICC - CLA		
Peso Weight	460 g/m ² ISO 2286-2		
Composizione Composition	 22% filato di poliestere ad alta tenacità 22% high tenacity polyester yarn	 61% PVC 61% PVC	 17% fibra sintetica 17% synthetic fiber
Fattore di apertura Openness factor	8%		
Resistenza all'abrasione Abrasion resistance	>120 000 cycles >400 000 double rubs - Heavy Duty		
Resistenza alla luce Light stability	EN ISO 12947-2 Martindale ASTM D4157 Wyzenbeek		
Resistenza allo strappo Tear strength	GS=4 at 700 h / >1,500 QUV ASTMG154: UVA340		
Resistenza alla rottura Break strength	Warp: 40 daN - Weft: 30 daN DIN 53363		
Allungamento sotto carico di 20 daN Elongation under 20 daN	Warp: ≤2,5% - Weft: ≤4% ISO 1421		
Test di pilling Pilling test	4		

Valori suscettibili alla tolleranza di +/- 5%. Sensitive values of tolerance +/- 5%.

— Qualities / Qualità





STL STEEL



CRC CROCODILE

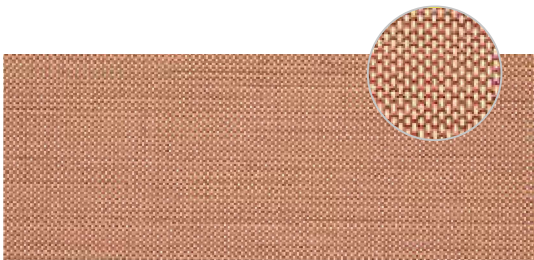

OCR OCRE

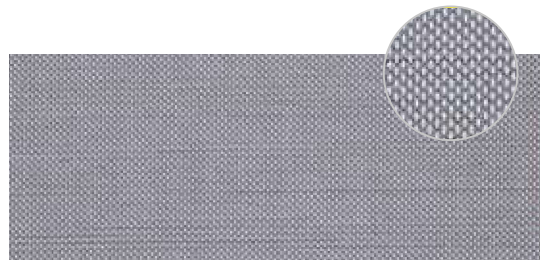

ICC ICE CUBE

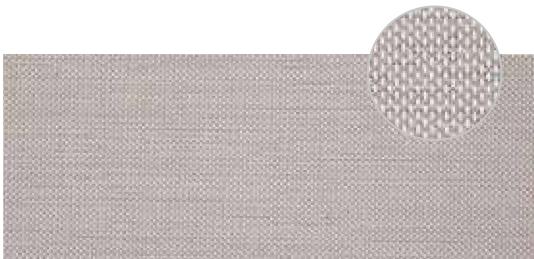

CLA CLAY

HPL

__ HPL is a composite material made of layers of cellulose fibers impregnated with thermosetting resins, such as phenolic or epoxy resins, subjected to a high-pressure and high-temperature process. This process, which simultaneously applies heat and pressure, transforms the layers into a rigid and durable sheet, ideal for outdoor use due to its high resistance to atmospheric agents. HPL surfaces offer numerous advantages, including: high resistance to scratches and wear, ease of cleaning thanks to low dirt and stain absorbency, resistance to high temperatures and chemical agents.

__ L'HPL è un materiale composito costituito da strati di fibre di cellulosa impregnate con resine termoindurenti, come resine fenoliche o epossidiche, sottoposte a un processo di alta pressione e temperatura. Questo processo, che applica simultaneamente calore e pressione, trasforma gli strati in un foglio rigido e resistente, ideale per l'uso esterno grazie alla sua elevata resistenza agli agenti atmosferici. Le superfici in HPL presentano numerosi vantaggi, tra cui: alta resistenza ai graffi e all'usura, facilità di pulizia grazie alla bassa assorbenza di sporco e macchie, resistenza alle alte temperature e agli agenti chimici.



CE ASH GREY / CENERE



SA SAMOA



Sales terms and conditions

1. Definitions

The Parties conventionally assign the following meanings to the following expressions: "Seller" means VERMOBIL STYLE SRL; "Purchaser" means the purchaser of the Products indicated in the relevant sales invoice; "Products" means the products described in the back of this document; "Territory" means the State in which the products will be delivered by the Seller. "Sales Price" means the price indicated on the invoice.

2. Validity of conditions and annexes

2a) The General Conditions are the only conditions applicable in relation to the sale of the Products and, without prejudice to any mandatory provisions of law, apply to the exclusion of any other condition implicit or explicit.

2b) These General Conditions (together with the "Contract") represent the entire agreement between the parties in relation to the sale of the relative Products and replace any previous promise, declaration or obligation between them.

2c) The General Conditions may be waived or amended only by written agreement between the Purchaser and the Seller.

3. Orders and conclusion of contract

The Contract for the sale of Products between the parties shall be effective when the Purchaser receives an order confirmation from the Seller ("Order Confirmation"). Any offer or estimate sent by the Seller to the Purchaser in relation to the Products (in whatever form they are communicated) shall be considered subject to these General Conditions.

4. Price variation

The Seller reserves the right to modify, by simple written communication to the Purchaser at any time prior to the receipt by the Purchaser of the Order Confirmation, the purchase price of the products (the "Purchase Price") to include in the same any increase in the costs of raw materials, production, packaging, transport or labor.

For colours not included in the catalogue there is a minimum increase of 15% and in any case the supply is subject to the acceptance of VERMOBIL STYLE SRL.

5. Payment, due date

a) Unless otherwise agreed by the Seller, full payment of the Sales Price must be made by the date indicated on the applicable invoice.

b) All payments shall be made under the terms and conditions set out in this Contract. In case of delayed payment of the invoices, the Purchaser shall be charged, without the need for a formal notice of default, default interest at an amount equal to the interest rate of the main financial instrument of the European Central Bank as applied to its most recent refinancing operation, increased by 7 percentage points, pursuant to Italian Legislative Decree 231/2002.

c) Without prejudice to the aforementioned provisions, in the event that the payments are not made in accordance with the terms provided for in the General Conditions, the Seller shall have the right to suspend the delivery of the Products ordered by the Purchaser, until an agreement is reached on the payment of the amount due by the Purchaser.

d) Moreover, in the event that the payment of the Products is not made by the Purchaser in compliance with the terms provided for in the General Conditions, the Seller shall be entitled to be refunded by the Purchaser for all costs incurred for the recovery of the amounts due, including any bank, legal, extra-judicial or judicial expenses.

6. Delivery

a) The Products are delivered free at destination unless otherwise indicated in writing. For orders with a value of less than Euro 1,000.00 + VAT, a charge of Euro 25.00 + VAT is required. For the Islands, for orders with a value of less than Euro 1,000.00 + VAT, the transport costs are to be borne by the Purchaser. For orders higher than that amount, a contribution of 7% of the order value is required. For the smaller islands the transport is at the Purchaser's expense.

b) The delivery terms are merely indicative and the Seller shall not be liable for any delays, losses or damages incurred due to non-compliance with them.

c) Delivery to a destination different than the Purchaser's address is subject to a contribution of € 75,00 + VAT

7. Transfer of Ownership, Risk

a) Delivery of the Products notwithstanding, the ownership of the Products is retained by the Seller until full payment of the Sale Price by the Purchaser is received, pursuant to Article 1523 of the Italian Civil Code.

b) The Purchaser acknowledges and accepts that, until full payment of the Sale Price has been made, he will possess the Products only on behalf of the Seller, and will keep the Products distinct from other products, in perfect condition and in such a way that they can be readily identified and inspected by the Seller at any time.

c) In the event that the Products are delivered to an address different from that of the Purchaser, the Seller may at any time prior to the sale of the Products and upon notice to the Purchaser, given in reasonable advance, have access to the places where the Products have been delivered, in order to regain possession of the Products of which the Seller is still the owner, in accordance with the provisions of point a). The Purchaser hereby commits to undertake all that is necessary to allow the Seller to exercise such right.

d) The provisions of this article cannot be interpreted in the sense of giving the Purchaser the right to return the Products or to refuse, postpone or suspend payment of the same, unless otherwise agreed between the parties.

8. Warranty

a) The Seller guarantees that at the time of delivery the Products are free from defects and meet the specifications indicated by the Seller, provided that such products are used by the Purchaser for purposes consistent with those for which such types of products are normally used. In the event that the Seller has not communicated any particular specification in relation to a given product, such product, at the time of delivery, shall be deemed to meet the ordinary quality standards of the relevant market for comparable industrial products. Without prejudice to the provisions of article 8b) and, in the event that a Product does not conform to the above warranty, the Seller shall be entitled, at its sole discretion, to: 1) replace the Products or parts thereof that do not conform; 2) modify the Products to make them conform to the specifications indicated by the Seller or (as the case may be) to market quality standards for comparable products; 3) withdraw the non-conforming Products and refund the relevant sales price in full.

b) The above warranty shall be valid on the condition that:

1) the Purchaser has complied with the provisions of article 10 below, to the extent applicable; 2) the Purchaser has notified the Seller in writing and documented the defects by means of photos on traditional or digital media within 14 (fourteen) days from the delivery of the Products in the case of easily recognizable defects and within 14 (fourteen) days from detection for hidden defects. The Purchaser's warranty claims become time-barred in any case after 2 (two) years from the delivery of the Products; 3) the Purchaser shall grant the Seller the opportunity to inspect the Products in a reasonable manner; 4) the Purchaser has ceased to use non-conforming products from the moment of discovery of the notified defects.

c) Without prejudice to the provisions of article 8a) above and without prejudice to any mandatory provisions of law:

1) any other guarantee, explicit or implicit, regarding the quality, marketability or suitability of the Products for specific purposes is expressly excluded; 2) the Seller shall not be held liable for any loss or damage suffered by the Purchaser as a result of the defect or non-functioning of the product not covered by this guarantee. d) The Seller shall make every reasonable effort to provide the Purchaser with any instructions, recommendations and advice for the storage, use and conditions of use of the Products. It is understood that it shall be the Purchaser's responsibility to ensure that the Products are used in accordance with the relative specifications and intended use of the Products themselves.

9. Quantity

The Purchaser shall notify the Seller in writing, by fax or PEC (Italian legally certified e-mail), of any delivery of a quantity of Products other than the quantity originally ordered by the Purchaser (whether higher or lower), within the mandatory term of 8 (eight) days from the date of receipt of the goods.

a) If the quantity of Products delivered to the Purchaser should be less than the quantity ordered by the same, the Purchaser shall have the right to obtain: 1) the missing quantity compared to the initial order; 2) a reduction in the Selling price;

b) If the quantity of Products delivered to the Purchaser should be greater than the quantity ordered by the same, the Purchaser shall have the right, alternatively, to: 1) return the quantity of Products delivered in excess; 2) retain the entire quantity of Products delivered, paying the entire Sale Price of the same.

c) It is however understood that the possible delivery of a quantity of Products different from the one ordered (whether higher or lower) shall not entitle the Purchaser to refuse the supply and that any return of Products shall, in any case, be previously agreed upon pursuant to article 11 and provided that timely notice has been given pursuant to article 10 letter b) below.

10. Notification of defects or of missing and/or nonconformant delivery

a) The Purchaser shall notify the Seller in writing, by fax or PEC (Italian legally certified e-mail), about any event which is deemed to be covered by the warranty referred to in article 8, no later than the terms referred to in article 8b.2, under penalty of forfeiture.

b) The Purchaser shall also notify the Seller in writing about any delivery of a nonconforming quantity of Products no later than the terms referred to in article 8, under penalty of forfeiture and for the purpose of exercising the rights.

c) After the term referred to in article 10b above has elapsed, the quantity of Products actually delivered to the Purchaser shall be deemed fully accepted by the Purchaser. Therefore, the Purchaser shall be under the obligation to pay in full the purchase price indicated in the invoice issued for the products actually delivered.

11. Product returns

Under no circumstances may a product be returned to the Seller without the Seller's prior written consent.

12. Intellectual Property

a) For the purpose of intellectual property, the Seller guarantees only that the delivery and use of the Products do not infringe any patent, industrial design, copyright, registered trademark or trade secret of any third party existing in the Territory at the date of the "Products" (the "Intellectual Property Rights"). The Seller shall compensate the Purchaser for any damages suffered as a failure by the Seller to comply with this warranty.

b) The warranty does not apply, and therefore the Purchaser shall not be entitled to any compensation whatsoever, in any of the following cases:

1) for the supply of the Products, the Seller has applied and adhered to specific instructions by the Purchaser which have led to a violation of the Intellectual Property Rights;

2) the violation of the Intellectual Property Rights is caused by the use of the Products in ways, or for purposes and/or in places not previously specified or otherwise indicated in writing to the Seller;

3) the Purchaser has not informed the Seller in writing about the existence of complaints, claims or legal actions (taken or threatened) against the Purchaser during the subsequent thirty days from receipt of such complaints or claims or actions and relating to Intellectual Property Rights;

4) the Purchaser, while compliant with the provisions of paragraph 12.a.3 above, does not allow the Seller to assume - at its own expense - the management of the dispute or to participate in any transactions.

c) The Purchaser guarantees that any indication or specific instruction provided to the Seller and relating to the supply of Products shall not cause a violation, by the Seller, of Third Party Intellectual Property Rights, and agrees to compensate the Seller for all damages that the latter may suffer in the event of such a violation occurring.

13. Force majeure

Seller shall not be liable for any loss or damage caused by delay in performance or failure to perform its obligations under this Agreement if such loss or damage is due to any cause beyond its control, including but not limited to war, civil unrest, riots, orders or prohibitions imposed by law or public authority, import or export regulations, strikes or labour unrest (affecting its own employees or employees of others) difficulty in finding personnel or materials, machine failures, fires or accidents. Where any such event occurs, Seller may terminate or suspend performance of this Agreement without incurring any liability for any loss or damage arising in connection with such action.

14. Taxation

The Sale Price and any other amount payable to Seller under this Agreement shall be subject to Value Added Tax (any new tax applicable to the sale, production or transportation of the Products other than Seller's income tax) to the full extent of the law and where applicable.

15. Transfer

This Contract may be transferred by the Purchaser only with the prior written consent of the Seller.

16. Applicable law - Jurisdiction

16. Applicable law - Jurisdiction

The present Contract is governed for all intents and purposes by Italian law. Any dispute, however related to this Agreement, will be subject to the exclusive jurisdiction of the Law Courts of Perugia.

Condizioni generali di vendita

1. Definizioni

Alle seguenti espressioni le Parti attribuiscono convenzionalmente i significati qui precisati: " Venditore " indica VERMOBIL STYLE SRL; "Compratore" indica l'acquirente dei Prodotti indicato nella relativa fattura di vendita; " Prodotti"designa i prodotti descritti nel retro del presente documento; " Territorio " indica lo Stato nel quale i prodotti verranno consegnati dal Venditore. "Prezzo di vendita" indica il prezzo riportato in fattura.

2. Efficacia delle condizioni e degli allegati

2a) Le condizioni Generali sono le uniche condizioni applicabili in relazione alla vendita dei Prodotti e, ferme restando le eventuali disposizioni inderogabili di legge, si applicano con esclusione di ogni altra condizione implicita o esplicita.

2b) Le presenti Condizioni Generali (congiuntamente al "Contratto") costituiscono l'intero accordo tra le parti in relazione alla vendita dei relativi Prodotti e sostituiscono ogni precedente promessa, dichiarazione o obbligazione tra le stesse.

2c) Le Condizioni Generali potranno essere derogate o modificate solo a seguito di accordo scritto tra Compratore e Venditore.

3. Ordini e perfezionamento del contratto

Ciascun Contratto per la vendita di Prodotti tra le parti si intenderà perfezionato nel momento in cui il Compratore riceverà una conferma d'ordine del Venditore (la "Conferma d'Ordine"). Qualsiasi offerta o preventivo inviato dal Venditore al Compratore in relazione ai Prodotti (in qualsiasi forma gli stessi siano comunicati) deve intendersi soggetto alle presenti Condizioni Generali.

4. Variazione di prezzo

Il Venditore si riserva il diritto di modificare, mediante semplice comunicazione scritta al Compratore in qualsiasi momento precedente alla ricezione, da parte del Compratore stesso, della Conferma d'Ordine, il prezzo di acquisto dei prodotti (il "Prezzo di Acquisto") per includere nello stesso ogni incremento dei costi delle materie prime, della produzione, delle confezioni, del trasporto o della manodopera.

Per colori non riportati a catalogo è prevista una maggiorazione minima del 15% e comunque la fornitura è subordinata all'accettazione della VERMOBIL STYLE SRL.

5. Pagamento

a) Salvo quanto diversamente stabilito dal Venditore, il pagamento integrale del Prezzo di Vendita deve essere effettuato entro la data indicata nella rispettiva fattura.

b) Tutti i pagamenti dovranno essere effettuati nel rispetto dei termini e delle modalità previsti nel presente Contratto. In caso di ritardato pagamento delle fatture matureranno a carico del Compratore, senza necessità di costituzione di mora, interessi moratori in misura pari al tasso di interesse del principale strumento di finanziamento della Banca Centrale Europea applicato alla sua più recente operazione di rifinanziamento, maggiorato di 7 punti percentuali, ex D.lgs.231/2002.

c) Fermo restando quanto sopra, nel caso in cui i pagamenti non venissero effettuati nel rispetto dei termini previsti nelle Condizioni Generali, il Venditore avrà il diritto di sospendere la consegna dei Prodotti ordinati dal Compratore, fintantoché non venga raggiunto un accordo sul pagamento di quanto dovuto dal Compratore.

d) Nel caso in cui il pagamento dei Prodotti non venisse effettuato dal Compratore nel rispetto dei termini previsti nelle Condizioni Generali, inoltre, il Venditore avrà il diritto di ottenere dal Compratore stesso il rimborso di tutti i costi sostenuti per il recupero degli importi scaduti, incluse eventuali spese bancarie, legali sia stragiudiziali che giudiziali.

6. Consegna

a) I Prodotti sono consegnati franco destino salvo diverse indicazioni scritte. Per ordini di valore inferiore a Euro1.000,00 + iva è richiesto un a carico del Compratore di € 25,00 + iva. Per le Isole, per gli ordini di valore inferiore a Euro 1.000,00 + iva le spese di trasporto sono a carico del Compratore. Per ordini superiori è richiesto un contributo pari al 7% del valore dell'ordine. Per le isole minori il trasporto è a carico del Compratore.

b) I termini di consegna sono indicativi e il Venditore non sarà responsabile per eventuali ritardi, perdite o danni subiti a causa del mancato rispetto degli stessi.

c) Consegna su destinazione diversa contributo di € 75,00 + Iva

7. Riserva di proprietà e rischio

a) Indipendentemente dalla consegna dei prodotti, la vendita si intende effettuata con riserva di proprietà dei prodotti medesimi in capo al Venditore fino all'integrale pagamento del Prezzo di Vendita da parte del Compratore ai sensi e per gli effetti di cui all'art.1523 c.c..

b) Il Compratore riconosce ed accetta che, fino al momento in cui non verrà effettuato il pagamento integrale del Prezzo di Vendita, sarà possessore dei prodotti esclusivamente in qualità di depositario del Venditore e provvederà a conservare i Prodotti separatamente da altri prodotti, in perfetto stato e in maniera tale

che gli stessi siano prontamente identificabili ed ispezionabili dal Venditore in qualsiasi momento.

c) Nel caso in cui i Prodotti vengono consegnati ad un indirizzo diverso da quello del Compratore, il Venditore potrà in qualsiasi momento antecedente alla vendita dei Prodotti e previa comunicazione al Compratore, con congruo preavviso, avere accesso ai luoghi in cui sono stati consegnati i Prodotti stessi per poterne riprendere il possesso dei Prodotti di cui il Venditore sia ancora proprietario, in forza di quanto previsto al punto a). Il Compratore si obbliga sin d'ora a compiere quanto necessario per consentire al Venditore l'esercizio di tale diritto.

d) Le disposizioni di cui al presente articolo non possono essere interpretate nel senso di attribuire al Compratore il diritto di restituire i Prodotti o di rifiutare, rinviare o sospendere il pagamento degli stessi, salvo che non sia stato altrimenti stabilito tra le parti.

8. Garanzie

a) Il Venditore garantisce che al momento della consegna i Prodotti sono esenti da vizi e rispondono alle specifiche indicate dal Venditore stesso, purché tali prodotti siano utilizzati dal Compratore per finalità conformi a quelle per cui tale tipologia di prodotti viene normalmente utilizzata. Nel caso in cui il Venditore non abbia comunicato alcuna particolare specifica in relazione ad un determinato prodotto, lo stesso, al momento della consegna, si intende rispondente agli ordinari standard qualitativi di mercato per prodotti industriali simili. Fermo restando quanto previsto dall'articolo 8b) e, nel caso in cui un Prodotto risulterà non conforme alla garanzia di cui sopra, il Venditore, avrà diritto a propria discrezione, di: 1) sostituire i Prodotti o parti di essi non conformi; 2) modificare i Prodotti per renderli conformi alle specifiche indicate dal Venditore o (a seconda del caso) a standard qualitativi di mercato per prodotti simili; 3) ritirare i Prodotti non conformi e rimborsare totalmente il relativo prezzo di vendita.

b) La garanzia di cui sopra, opererà a condizione che:

1) il Compratore abbia osservato le disposizioni del successivo articolo 10, per quanto applicabili; 2) il Compratore abbia comunicato per iscritto e documentato tramite foto su supporto tradizionale o digitale al Venditore i vizi entro 14 (quattordici) giorni dalla consegna dei Prodotti nel caso di vizi facilmente riconoscibili ed entro 14 (quattordici) giorni dalla scoperta di vizi occulti. L'azione del Compratore si prescriverà in ogni caso entro 2 (due) anni dalla consegna dei prodotti; 3) il Compratore conceda al Venditore la possibilità di ispezione, con modalità ragionevoli, i Prodotti;

4) il Compratore abbia cessato l'utilizzo di prodotti non conformi dal momento della scoperta dei difetti dallo stesso dichiarati. c) Fermo restando quanto previsto dall'articolo 8a) che precede e fatte salve le eventuali disposizioni inderogabili di legge:

1) è espressamente esclusa qualsiasi altra garanzia, esplicita o implicita, in merito alle qualità, alla commerciabilità o all'idoneità dei Prodotti per fini specifici; 2) il Venditore non sarà ritenuto responsabile per eventuali perdite o danni subiti dal Compratore a causa del difetto o del non funzionamento del prodotto non coperto dalla presente garanzia. d) Il Venditore farà quanto ragionevolmente possibile per fornire al compratore eventuali istruzioni, raccomandazioni e consigli per la conservazione, l'utilizzo dei Prodotti e le relative condizioni d'impiego. Resta inteso che sarà responsabilità del Compratore assicurare che i Prodotti vengano utilizzati in conformità alle relative specifiche e modalità d'uso dei prodotti medesimi.

9. Quantità

Il Compratore dovrà comunicare per iscritto, con lettera da inoltrarsi a mezzo telefax o pec, al Venditore l'eventuale consegna di un quantitativo di Prodotti difforme (sia esso superiore o inferiore) rispetto a quello

originariamente ordinato dal Compratore stesso, entro il termine perentorio di 8 (otto) giorni dalla data di ricevimento della merce.

a) Nel caso in cui la quantità di Prodotti consegnata al Compratore dovesse essere inferiore alla quantità dallo stesso ordinata, il Compratore avrà diritto di ottenere: 1) il quantitativo mancante rispetto all'ordine iniziale, 2) una riduzione del prezzo di Vendita;

b) Nel caso in cui la quantità di Prodotti consegnata al Compratore dovesse essere superiore alla quantità dallo stesso ordinata, il Compratore avrà diritto, alternativamente, di: 1) restituire il quantitativo di Prodotti consegnato in eccesso; 2) trattenere l'intero quantitativo di Prodotti consegnato, corrispondendo l'intero Prezzo di Vendita degli stessi.

c) Resta comunque inteso che l'eventuale consegna di un quantitativo di Prodotti diverso rispetto a quello ordinato (sia esso superiore o inferiore) non darà diritto al Compratore di rifiutare la fornitura e che qualsiasi

restituzione di Prodotti dovrà, comunque, essere preventivamente concordata ai sensi dell'articolo 11 e sempre che sia stata data tempestiva denuncia ai sensi del successivo art.10 lett.b).

10. Comunicazione di vizi o mancata e/o difforme consegna

a) il Compratore dovrà comunicare per iscritto, con lettera da

inoltrarsi a mezzo telefax o pec, al Venditore ogni evento ritenuto coperto dalla garanzia di cui all'articolo 8 A) entro e non oltre i termini di cui all'articolo 8 B.

2., a pena di decadenza.

b) il Compratore dovrà, altresì, comunicare per iscritto al Venditore l'eventuale consegna di un quantitativo di Prodotti difforme entro e non oltre i termini di cui all'articolo 8 a pena di decadenza ed ai fini dell'esercizio dei diritti.

c) Decorso il termine di cui all'articolo 10b) che precede, il quantitativo di Prodotti effettivamente consegnati al Compratore si considererà dallo stesso definitivamente accettato. In tale circostanza il Compratore sarà pertanto obbligato a pagare integralmente il Prezzo d' Acquisto indicato nella fattura relativa ai Prodotti effettivamente consegnati.

11. Restituzione dei prodotti

In nessun caso un prodotto potrà essere restituito al Venditore senza il preventivo consenso scritto di quest'ultimo.

12. Diritti di proprietà intellettuale

a) In relazione alla proprietà intellettuale, il Venditore garantisce esclusivamente che la consegna e l'utilizzo dei Prodotti non violano alcun brevetto, disegno o modello industriale, diritto d'autore, marchio registrato o segreto aziendale di terzi esistenti nel Territorio alla data dei " Prodotti " (i " Diritti di Proprietà Intellettuale "). Il Venditore risarcirà al Compratore gli eventuali danni che lo stesso dovesse subire per effetto della violazione di tale garanzia. b) La garanzia non si applica e, pertanto, il Compratore non avrà diritto a risarcimento alcuno, qualora si verifichi anche una sola delle seguenti ipotesi:

1) il Venditore abbia adottato e seguito, per la fornitura dei Prodotti, istruzioni specifiche del Compratore che abbiano determinato una violazione dei Diritti di Proprietà Intellettuale; 2) la violazione dei Diritti di Proprietà Intellettuale sia causata dall'utilizzo dei Prodotti con modalità, ovvero per finalità e/o in luoghi non preventivamente specificati o altrimenti indicati per iscritto al Venditore; 3) il Compratore non abbia informato il Venditore per iscritto dell'esistenza di contestazioni, reclami o azioni giudiziali (intraprese o minacciate) nei confronti del Compratore stesso entro i successivi trenta giorni dal ricevimento di dette contestazioni o reclami o azioni e relativi ai Diritti di Proprietà Intellettuale; 4) il Compratore, pur avendo osservato quanto previsto al precedente punto 12.a.3, non consente al Venditore di assumere – a proprie spese – la gestione della lite o di partecipare ad eventuali transazioni. c) il Compratore garantisce che qualsiasi indicazione o specifica istruzione relativa alla fornitura di Prodotti eventualmente fornita al Venditore, non causerà una violazione, da parte del Venditore, di Diritti di Proprietà Intellettuale di Terzi e si obbliga a risarcire al Venditore tutti i danni che quest'ultimo dovesse subire nel caso tale violazione dovesse verificarsi.

13. Forza maggiore

Il Venditore non sarà responsabile per eventuali perdite o danni causati dal ritardo nell'adempimento o dall'inadempimento delle proprie obbligazioni ai sensi del presente Contratto nel caso in cui gli stessi siano dovuti ad una qualsiasi causa che sia fuori dal proprio controllo, inclusi, a titolo esemplificativo e non esaustivo, guerre, sommosse civili, ordine o divieto sopravvenuto imposto dalla normativa o da pubbliche autorità, regolamenti relativi alle importazioni o alle esportazioni, scioperi o agitazioni sindacali (relativi ai propri dipendenti o ai propri dipendenti di altri soggetti) difficoltà nel rintracciare personale o materiali, guasti di macchinari, incendi o incidenti. Nel caso in cui si verifichi uno qualsiasi di tali eventi, il Venditore potrà risolvere il presente Contratto o sospendere l'esecuzione senza incorrere in alcuna responsabilità per qualsiasi perdita o danno derivanti da tale azione.

14. Tasse

Il Prezzo di Vendita ed ogni altra somma dovuta al Venditore ai sensi del presente Contratto è soggetta all'applicazione dell'Imposta sul Valore Aggiunto (qualsiasi nuova imposta applicabile alla vendita, produzione o trasporto dei Prodotti diversa da un'imposta sul reddito del Venditore) nella misura di legge e ove previste.

15. Cessione
Il presente Contratto potrà essere ceduto dal Compratore solo con il preventivo consenso scritto del Venditore.

16. Legge applicabile - Foro competente

Il presente Contratto è governato a tutti gli effetti dalla legge italiana. Qualsiasi controversia, comunque, connessa al presente Contratto sarà soggetta alla competenza esclusiva del Foro di Perugia.

Vermobil reserves the right to eliminate or modify any of its products at any time without notice, with the aim constant quality improvement. The photos reproduced in the catalogue and references to colours are as faithful to the originals as possible, in so far as the best printing techniques allow.

It is absolutely forbidden to reproduce even partially, the pictures in this catalogue without the company's expressed permission. The drawings, dimensions, colours of the products shown in this catalog are purely indicative. Al fine del continuo miglioramento della qualità, Vermobil si riserva la facoltà di eliminare e modificare i prodotti in qualsiasi momento senza essere tenuta a darne preavviso. Le foto riprodotte nel catalogo sono quanto più possibile fedeli agli originali, compatibilmente con le migliori tecniche di stampa e riproduzione. È fatto assoluto divieto di riprodurre le immagini di questo catalogo, anche parzialmente, senza espressa autorizzazione dell'azienda. I disegni, le quote, i colori dei prodotti raffigurati nel presente catalogo sono a titolo indicativo.

Vermobil Style

Via Antonio da Migliano, 1
06055 Marsciano (PG)
Tel +39.075.8742662
vermobil@vermobil.it
www.vermobil.it

Designs and planning:
Vermobil's Technical and Marketing Department
Photo: Mauro Mattioli
Creative direction: Fotostudio Mattioli





www.vermobil.it